

Modular Enclosures

Data Standard Enclosure 29" Wide x 30" Deep

BST-Style Data Standard Enclosure



Data Standard Enclosure

The Data Standard is a freestanding enclosure that easily accommodates large components. The unit's mounting rails can be adjusted, after installation, from 19" EIA to 23" EIA spacing to allow for cable management and different depths of equipment. Among the many features and benefits of this modular unit are:

- **Reversible Doors:** Spring-loaded hinges allow quick change of door swing.
- **Lift-off Side Panels:** Flush surface lock fasteners permit quick disconnect and lift off.
- **Cable Gland Plate:** Adjustable bottom plate minimizes dirt and dust inside the enclosure.
- **Cable Access Top:** Features a 14.25" x 4" cable access rubber gland which helps prevent dust from entering the enclosure.
- **Rear Cable Plate:** Two, 3-7/8" x 8-1/2" openings for cable access with removable plates and edge grommet kit. Also features two 1.75" capped openings.
- **Tempered Safety Glass:** Strengthens door and its easy-to-clean, non-scratching, tinted bronze color enhances overall appearance.
- **Grounding kit Included.**

Frames



BST 48

BST 72

BST 78

BST 84

These products are in the process of being assessed for RoHS compliance. Please check our Web Site for the most current RoHS status.

Modular Enclosures

Data Standard Enclosure

29" Wide x 30" Deep (continued)

Dimensions

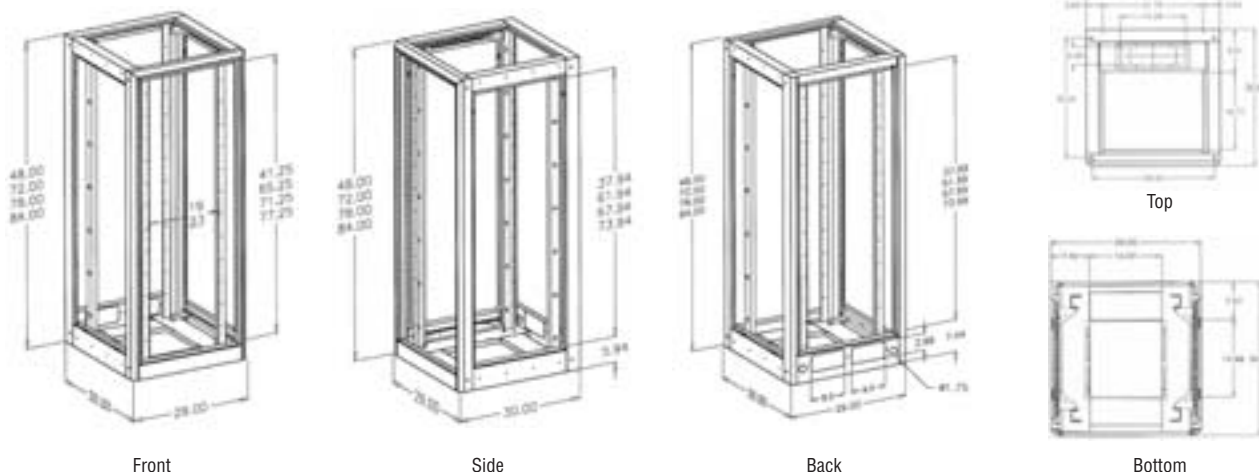

Technical Specifications

Enclosure Size		H	W	D	Weight	Mounting	Rack Spaces
BST48	Frame, Gland Plate, Casters & Levelers	48"	29"	30"	230 lb	19", 23" or Frame Mount Shelf	25U
BST72	Frame, Gland Plate, Casters & Levelers	72"	29"	30"	325 lb	19", 23" or Frame Mount Shelf	39U
BST78	Frame, Gland Plate, Casters & Levelers	78"	29"	30"	350 lb	19", 23" or Frame Mount Shelf	42U
BST84	Frame, Gland Plate, Casters & Levelers	84"	29"	30"	360 lb	19", 23" or Frame Mount Shelf	46U

EIA - 310 - D Compliant

Description	Belden Part Number
Data Standard 84" Black, 19" Mounting, 10" Fan Top, Glass Door, Vented Rear Door, Two Sides, 20 Amp Power Strip	BST84-3-122226
Data Standard 84" Black Frames w/19" Mounting	BST84-3-100000

How To Order

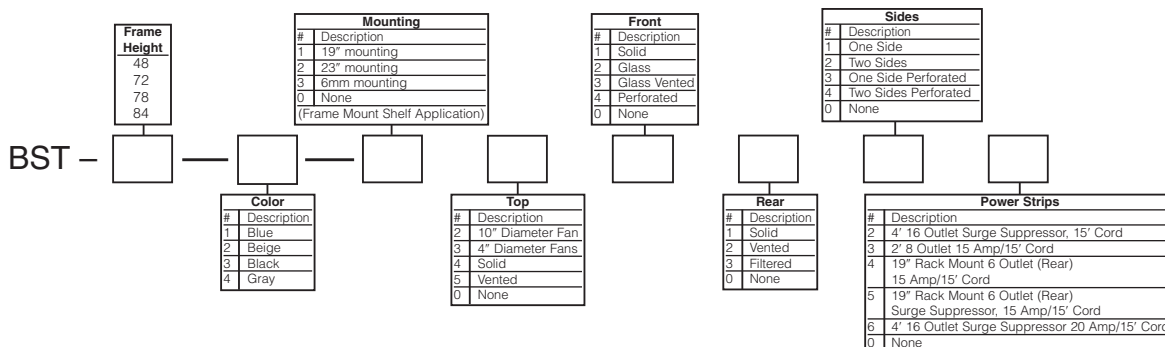

These products are in the process of being assessed for RoHS compliance. Please check our Web Site for the most current RoHS status.



Modular Enclosures

Data Standard Enclosure

29" Wide x 30" Deep (continued)

Solid Front Door



Tempered Glass Front Door



Rear Doors: Solid, Vented, Filtered



Side Panels

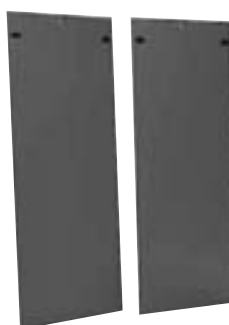

Removable Tops



Description	Belden Part Number
Front Doors	
Solid Front Door	
Solid Steel Front Door with Latch and Lock, 48"	B4829-SF-C
Solid Steel Front Door with Latch and Lock, 72"	B7229-SF-C
Solid Steel Front Door with Latch and Lock, 78"	B7829-SF-C
Solid Steel Front Door with Latch and Lock, 84"	B8429-SF-C
Tempered Glass Front Door	
Tempered Glass Front Door with Latch and Lock, 48"	B4829-GF-C
Tempered Glass Front Door with Latch and Lock, 72"	B7229-GF-C
Tempered Glass Front Door with Latch and Lock, 78"	B7829-GF-C
Tempered Glass Front Door with Latch and Lock, 84"	B8429-GF-C
Glass Vented Front Door	
Tempered Glass Front Vented Door with Latch and Lock, 48"	B4829-VF-C
Tempered Glass Front Vented Door with Latch and Lock, 72"	B7229-VF-C
Tempered Glass Front Vented Door with Latch and Lock, 78"	B7829-VF-C
Tempered Glass Front Vented Door with Latch and Lock, 84"	B8429-VF-C
Perforated Front Door	
Perforated Front Door with Latch and Lock, 48"	B4829-PD-C
Perforated Front Door with Latch and Lock, 72"	B7229-PD-C
Perforated Front Door with Latch and Lock, 78"	B7829-PD-C
Perforated Front Door with Latch and Lock, 84"	B8429-PD-C
Rear Doors	
Solid Rear Door	
Solid Steel Rear Door with Latch and Lock, 48"	B4829-SR-C
Solid Steel Rear Door with Latch and Lock, 72"	B7229-SR-C
Solid Steel Rear Door with Latch and Lock, 78"	B7829-SR-C
Solid Steel Rear Door with Latch and Lock, 84"	B8429-SR-C
Vented Rear Door	
Vented Steel Rear Door with Latch and Lock, 48"	B4829-VR-C
Vented Steel Rear Door with Latch and Lock, 72"	B7229-VR-C
Vented Steel Rear Door with Latch and Lock, 78"	B7829-VR-C
Vented Steel Rear Door with Latch and Lock, 84"	B8429-VR-C
Filtered Rear Door	
Filtered Rear Door with Latch and Lock, 48"	B4829-FR-C
Filtered Rear Door with Latch and Lock, 72"	B7229-FR-C
Filtered Rear Door with Latch and Lock, 78"	B7829-FR-C
Filtered Rear Door with Latch and Lock, 84"	B8429-FR-C
Side Panels	
Single Side Panels	
1-Solid Lift-off Side Panel with Lock, 48"	B4801-SP-C
1-Solid Lift-off Side Panel with Lock, 72"	B7201-SP-C
1-Solid Lift-off Side Panel with Lock, 78"	B7801-SP-C
1-Solid Lift-off Side Panel with Lock, 84"	B8401-SP-C
Pair of Side Panels	
2-Solid Lift-off Side Panels with Lock, 48"	B4802-SP-C
2-Solid Lift-off Side Panels with Lock, 72"	B7202-SP-C
2-Solid Lift-off Side Panels with Lock, 78"	B7802-SP-C
2-Solid Lift-off Side Panels with Lock, 84"	B8402-SP-C
Removable Tops	
Solid Top	B2918-TP-1-C
Vented Top	B2918-TP-2-C
Solid Top with 10" Diameter Fan, 550 CFM	B2918-TP-3-C
Solid Top with (4) 4" Diameter Fans, Four Fans = 320 CFM	B2918-TP-4-C

These products are in the process of being assessed for RoHS compliance. Please check our Web Site for the most current RoHS status.

Modular Enclosures

Data Deep Enclosure

29" Wide x 34" Deep

BDP-Style Data Deep Enclosure



Data Deep Enclosure

The Data Deep is a freestanding enclosure that features a 34" depth for mounting servers, UPS units, controllers, battery backups, network monitors and more. The unit's mounting rails can be adjusted, after installation, from 19" EIA to 23" EIA spacing to allow for cable management and different depths of equipment. Among the many features and benefits of this modular unit are:

- **Reversible Doors:** Spring-loaded hinges allow quick change of door swing.
- **Lift-off Side Panels:** Flush surface lock fasteners permit quick disconnect and lift off.
- **Cable Gland Plate:** Adjustable bottom plate minimizes dirt and dust inside the enclosure.
- **Cable Access Top:** Features a 14.25" x 4" cable access rubber gland which helps prevent dust from entering the enclosure.
- **Rear Cable Plate:** Two, 3-7/8" x 8-1/2" openings for cable access with removable plates and edge grommet kit. Also features two 1.75" capped openings.
- **Tempered Safety Glass:** Strengthens door and its easy-to-clean, non-scratching, tinted bronze color enhances overall appearance.
- **Grounding kit Included.**

Frames



BDP 72



BDP 78



BDP 84

These products are in the process of being assessed for RoHS compliance. Please check our Web Site for the most current RoHS status.

Modular Enclosures

Data Deep Enclosure
29" Wide x 34" Deep (continued)

Dimensions

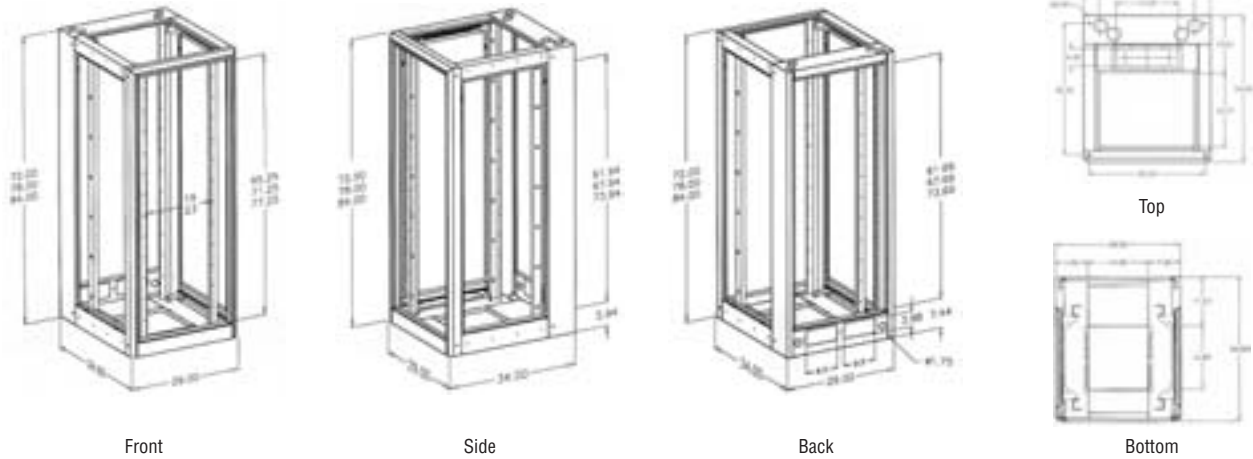

Technical Specifications

Enclosure Size		H	W	D	Weight	Mounting	Rack Spaces
BDP72	Frame, Gland Plate, Casters & Levelers	72"	29"	34"	350 lb	19", 23" or Frame Mount Shelf	39U
BDP78	Frame, Gland Plate, Casters & Levelers	78"	29"	34"	380 lb	19", 23" or Frame Mount Shelf	42U
BDP84	Frame, Gland Plate, Casters & Levelers	84"	29"	34"	390 lb	19", 23" or Frame Mount Shelf	46U

EIA - 310 - D Compliant

Description	Belden Part Number
Data Deep 84" Black, 19" Mounting, 10" Fan Top, Glass Door, Vented Rear Door, Two Sides, 20 Amp Power Strip	BDP84-3-122226
Data Deep 84" Black Frames w/19" Mounting	BDP84-3-100000

How To Order

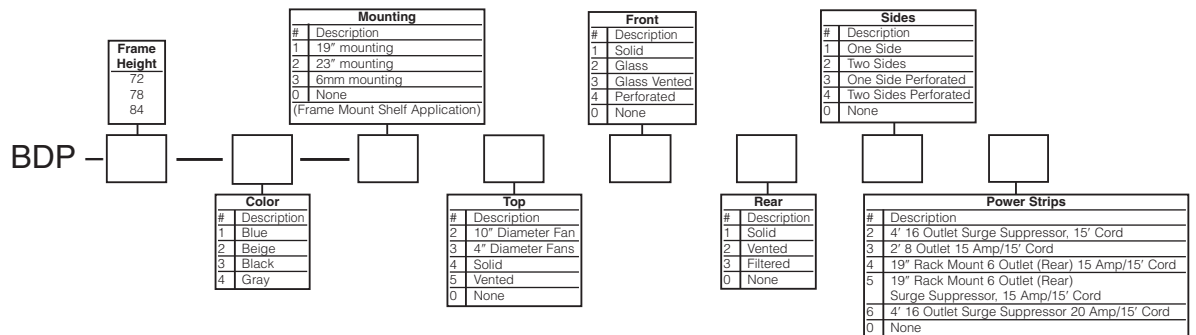

These products are in the process of being assessed for RoHS compliance. Please check our Web Site for the most current RoHS status.



For more information, contact Belden Technical Support: 1-800-BELDEN-1 • www.belden.com

Modular Enclosures

Data Deep Enclosure

29" Wide x 34" Deep (continued)

Tempered Glass Front Door



Rear Doors: Solid, Vented, Filtered



Side Panels

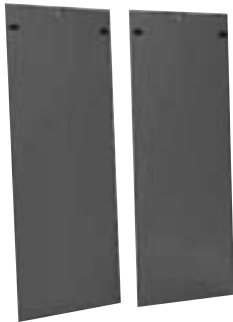

Removable Tops



Description	Belden Part Number
Front Doors	
Solid Front Door	
Solid Steel Front Door with Latch and Lock, 72"	B7229-SF-C
Solid Steel Front Door with Latch and Lock, 78"	B7829-SF-C
Solid Steel Front Door with Latch and Lock, 84"	B8429-SF-C
Tempered Glass Front Door	
Tempered Glass Front Door with Latch and Lock, 72"	B7229-GF-C
Tempered Glass Front Door with Latch and Lock, 78"	B7829-GF-C
Tempered Glass Front Door with Latch and Lock, 84"	B8429-GF-C
Glass Vented Front Door	
Tempered Glass Front Vented Door with Latch and Lock, 72"	B7229-VF-C
Tempered Glass Front Vented Door with Latch and Lock, 78"	B7829-VF-C
Tempered Glass Front Vented Door with Latch and Lock, 84"	B8429-VF-C
Perforated Front Door	
Perforated Front Door with Latch and Lock, 72"	B7229-PD-C
Perforated Front Door with Latch and Lock, 78"	B7829-PD-C
Perforated Front Door with Latch and Lock, 84"	B8429-PD-C
Rear Doors	
Solid Rear Door	
Solid Steel Rear Door with Latch and Lock, 72"	B7229-SR-C
Solid Steel Rear Door with Latch and Lock, 78"	B7829-SR-C
Solid Steel Rear Door with Latch and Lock, 84"	B8429-SR-C
Vented Rear Door	
Vented Steel Rear Door with Latch and Lock, 72"	B7229-VR-C
Vented Steel Rear Door with Latch and Lock, 78"	B7829-VR-C
Vented Steel Rear Door with Latch and Lock, 84"	B8429-VR-C
Filtered Rear Door	
Filtered Rear Door with Latch and Lock, 72"	B7229-FR-C
Filtered Rear Door with Latch and Lock, 78"	B7829-FR-C
Filtered Rear Door with Latch and Lock, 84"	B8429-FR-C
Side Panels	
Single Side Panel	
1-Solid Lift-off Side Panel with Lock, 72"	B7201-SP-C
1-Solid Lift-off Side Panel with Lock, 78"	B7801-SP-C
1-Solid Lift-off Side Panel with Lock, 84"	B8401-SP-C
Pair of Side Panels	
2-Solid Lift-off Side Panels with Lock, 72"	B7202-SP-C
2-Solid Lift-off Side Panels with Lock, 78"	B7802-SP-C
2-Solid Lift-off Side Panels with Lock, 84"	B8402-SP-C
Removable Tops	
Solid Top	B2918-TP-1-C
Vented Top	B2918-TP-2-C
Solid Top with 10" Diameter Fan, 550 CFM	B2918-TP-3-C
Solid Top with (4) 4" Diameter Fans, Four Fans = 320 CFM	B2918-TP-4-C

These products are in the process of being assessed for RoHS compliance. Please check our Web Site for the most current RoHS status.

Modular Enclosures

Data Slim Enclosure 24" Wide x 30" Deep

BSL-Style Data Slim Enclosure



Data Slim Enclosure

The Data Slim is a freestanding enclosure with a 24" footprint. This makes the enclosure ideal for computer rooms where space is at a premium. The unit's mounting rails have 19" EIA spacing to allow for cable management and different depths of equipment. Among the many features and benefits of this modular unit are:

- **Reversible Doors:** Spring-loaded hinges allow quick change of door swing.
- **Lift-off Side Panels:** Flush surface lock fasteners permit quick disconnect and lift off.
- **Cable Gland Plate:** Adjustable bottom plate minimizes dirt and dust inside the enclosure.
- **Cable Access Top:** Features a 14.25" x 4" cable access rubber gland which helps prevent dust from entering the enclosure.
- **Rear Cable Plate:** One, 3-7/8" x 8-1/2" openings for cable access with a removable plate and edge grommet kit. Also features two 1.75" capped openings.
- **Tempered Safety Glass:** Strengthens door and its easy-to-clean, non-scratching, tinted bronze color enhances overall appearance.
- **Grounding kit Included.**

Frames



BSL 48

BSL 72

BSL 78

BSL 84

These products are in the process of being assessed for RoHS compliance. Please check our Web Site for the most current RoHS status.

Modular Enclosures

Data Slim Enclosure

24" Wide x 30" Deep (continued)

Dimensions

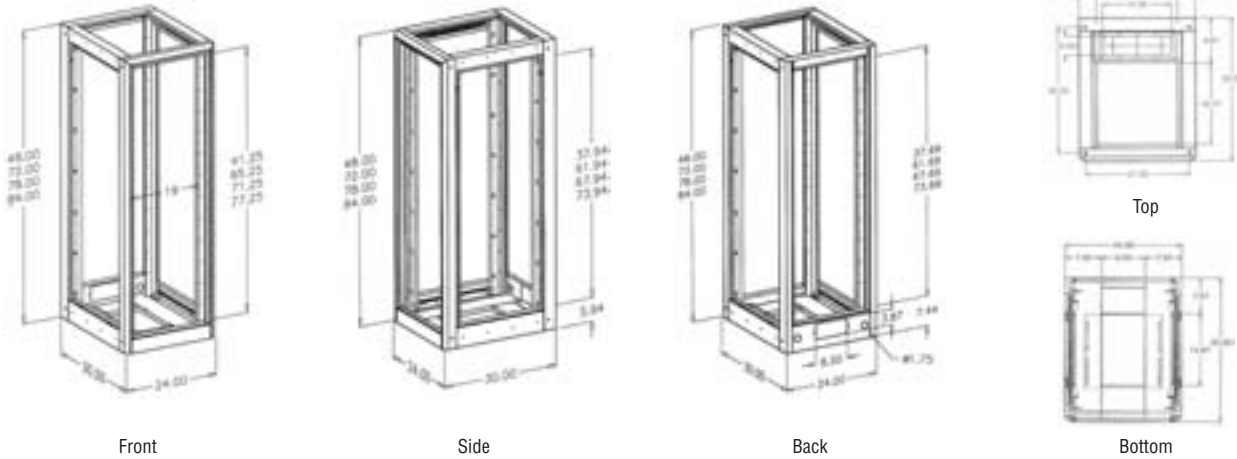

Technical Specifications

Enclosure Size		H	W	D	Weight	Mounting	Rack Spaces
BSL48	Frame, 2 pr 19" mtg Rails, Casters & Levelers	48"	24"	30"	230 lb	19"	25U
BSL72	Frame, 2 pr 19" mtg Rails, Casters & Levelers	72"	24"	30"	320 lb	19"	39U
BSL78	Frame, 2 pr 19" mtg Rails, Casters & Levelers	78"	24"	30"	340 lb	19"	42U
BSL84	Frame, 2 pr 19" mtg Rails, Casters & Levelers	84"	24"	30"	350 lb	19"	46U

EIA - 310 - D Compliant

Description	Belden Part Number
Data Slim 84" Black, 19" Mounting, 10" Fan Top, Glass Door, Vented Rear Door, Two Sides, 20 Amp Power Strip	BSL84-3-122226
Data Slim 84" Black Frames w/19" Mounting	BSL84-3-100000

How To Order

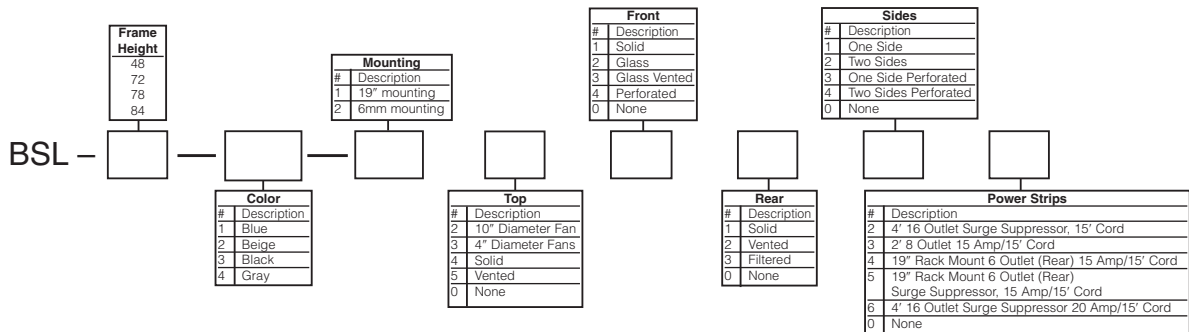

These products are in the process of being assessed for RoHS compliance. Please check our Web Site for the most current RoHS status.



Modular Enclosures

Data Slim Enclosure

24" Wide x 30" Deep (continued)

Solid Front Door



Tempered Glass Front Door

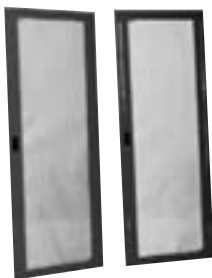

Rear Doors: Solid, Vented, Filtered



Side Panels

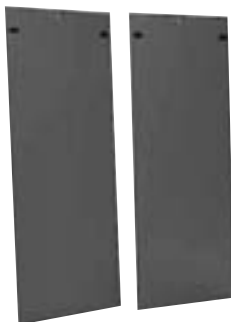

Removable Tops



Description	Belden Part Number
Front Doors	
Solid Front Door	
Solid Steel Front Door with Latch and Lock, 48"	B4824-SF-C
Solid Steel Front Door with Latch and Lock, 72"	B7224-SF-C
Solid Steel Front Door with Latch and Lock, 78"	B7824-SF-C
Solid Steel Front Door with Latch and Lock, 84"	B8424-SF-C
Tempered Glass Front Door	
Tempered Glass Front Door with Latch and Lock, 48"	B4824-GF-C
Tempered Glass Front Door with Latch and Lock, 72"	B7224-GF-C
Tempered Glass Front Door with Latch and Lock, 78"	B7824-GF-C
Tempered Glass Front Door with Latch and Lock, 84"	B8424-GF-C
Glass Vented Front Door	
Tempered Glass Front Vented Door with Latch and Lock, 48"	B4824-VF-C
Tempered Glass Front Vented Door with Latch and Lock, 72"	B7224-VF-C
Tempered Glass Front Vented Door with Latch and Lock, 78"	B7824-VF-C
Tempered Glass Front Vented Door with Latch and Lock, 84"	B8424-VF-C
Perforated Front Door	
Perforated Front Door with Latch and Lock, 48"	B4824-PD-C
Perforated Front Door with Latch and Lock, 72"	B7224-PD-C
Perforated Front Door with Latch and Lock, 78"	B7824-PD-C
Perforated Front Door with Latch and Lock, 84"	B8424-PD-C
Rear Doors	
Solid Rear Door	
Solid Steel Rear Door with Latch and Lock, 48"	B4824-SR-C
Solid Steel Rear Door with Latch and Lock, 72"	B7224-SR-C
Solid Steel Rear Door with Latch and Lock, 78"	B7824-SR-C
Solid Steel Rear Door with Latch and Lock, 84"	B8424-SR-C
Vented Rear Door	
Vented Steel Rear Door with Latch and Lock, 48"	B4824-VR-C
Vented Steel Rear Door with Latch and Lock, 72"	B7224-VR-C
Vented Steel Rear Door with Latch and Lock, 78"	B7824-VR-C
Vented Steel Rear Door with Latch and Lock, 84"	B8424-VR-C
Filtered Rear Door	
Filtered Rear Door with Latch and Lock, 48"	B4824-FR-C
Filtered Rear Door with Latch and Lock, 72"	B7224-FR-C
Filtered Rear Door with Latch and Lock, 78"	B7824-FR-C
Filtered Rear Door with Latch and Lock, 84"	B8424-FR-C
Side Panels	
Single Side Panels	
1-Solid Lift-off Side Panel with Lock, 48"	B4801-SP-C
1-Solid Lift-off Side Panel with Lock, 72"	B7201-SP-C
1-Solid Lift-off Side Panel with Lock, 78"	B7801-SP-C
1-Solid Lift-off Side Panel with Lock, 84"	B8401-SP-C
Pair of Side Panels	
2-Solid Lift-off Side Panels with Lock, 48"	B4802-SP-C
2-Solid Lift-off Side Panels with Lock, 72"	B7202-SP-C
2-Solid Lift-off Side Panels with Lock, 78"	B7802-SP-C
2-Solid Lift-off Side Panels with Lock, 84"	B8402-SP-C
Removable Tops	
Solid Top	B2418-TP-1-C
Vented Top	B2418-TP-2-C
Solid Top with 10" Diameter Fan, 550 CFM	B2418-TP-3-C
Solid Top with (4) 4" Diameter Fans, Four Fans = 320 CFM	B2418-TP-4-C

These products are in the process of being assessed for RoHS compliance. Please check our Web Site for the most current RoHS status.

Modular Enclosures

Ultra Server Enclosure

24" Wide x 36" Deep

BUS-Style Ultra Server Enclosure

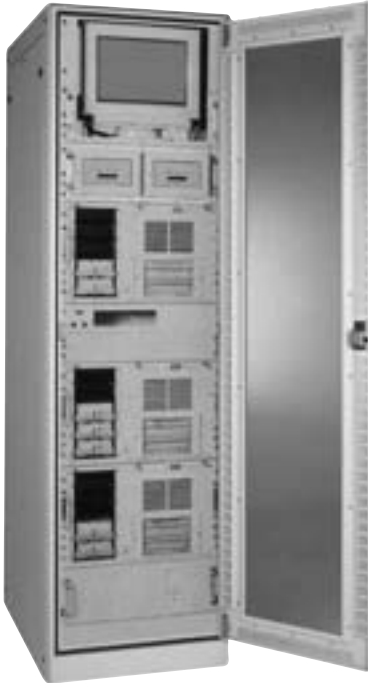

Ultra Server Enclosure

The Ultra Server is a freestanding enclosure with a 24" wide x 36" deep footprint. The enclosure features numerous top and bottom entry points for easy configuration to match your needs and an anti-tip device to prevent the enclosure from tipping when servers and shelves are extended. The unit's mounting rails have 19" EIA spacing to allow for cable management and different depths of equipment. Among the many features and benefits of this modular unit are:

- **Reversible Doors:** Spring-loaded hinges allow quick change of door swing.
- **Lift-off Side Panels:** Flush surface lock fasteners permit quick disconnect and lift off.
- **Door and Side Panel Security:** Doors and side panels lock; handles are flush mounted.
- **Cable Access Top:** Features a 14.25" x 4" cable access rubber gland which helps prevent dust from entering the enclosure.
- **Tempered Safety Glass:** Strengthens door and its easy-to-clean, non-scratching, tinted bronze color enhances overall appearance.
- **Grounding kit Included.**

Frames



BUS 78

BUS 84

These products are in the process of being assessed for RoHS compliance. Please check our Web Site for the most current RoHS status.

Modular Enclosures

Ultra Server Enclosure

24" Wide x 36" Deep (continued)

Dimensions

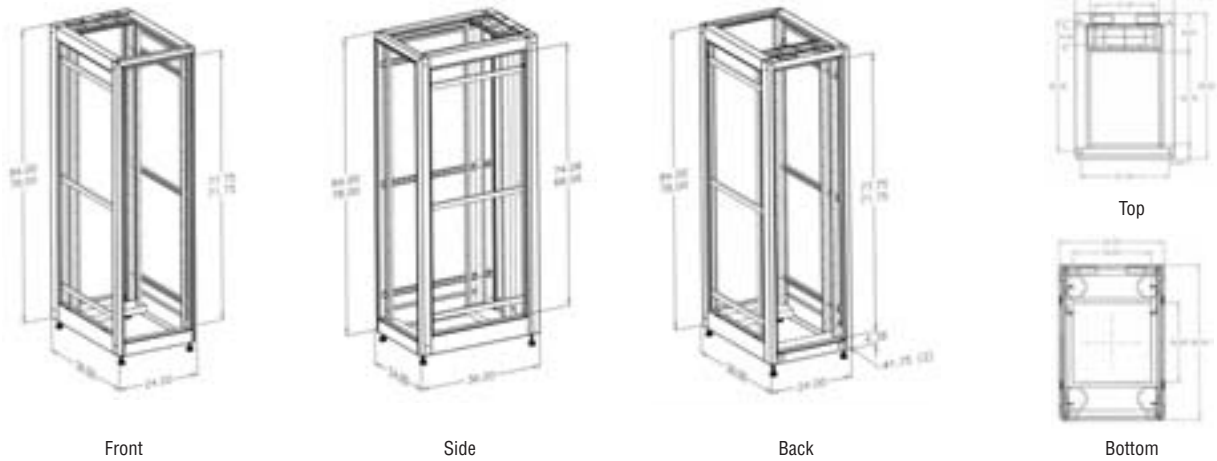

Technical Specifications

Enclosure Size		H	W	D	Weight	Mounting	Rack Spaces
BUS78	Frame, 3 pr 19" Mounting Rails, Casters & Levelers	78"	24"	36"	350 lb	19"	42U
BUS84	Frame, 3 pr 19" Mounting Rails, Casters & Levelers	84"	24"	36"	370 lb	19"	45U

EIA - 310 - D Compliant

Description	Belden Part Number
Ultra Server 84" Black, 19" Mounting, 10" Fan Top, Perforated Slam Front and Rear Doors, Two Sides, 20 Amp Power Strip	BUS84-3-122226
Ultra Server 84" Black Frames w/19" Mounting	BUS84-3-100000

How To Order

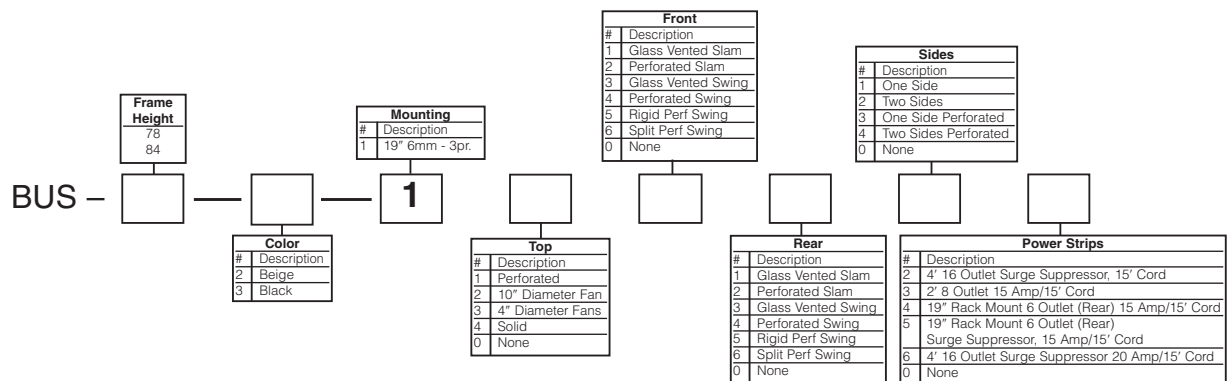

These products are in the process of being assessed for RoHS compliance. Please check our Web Site for the most current RoHS status.



For more information, contact Belden Technical Support: 1-800-BELDEN-1 • www.belden.com

Modular Enclosures

Ultra Server Enclosure

24" Wide x 36" Deep *(continued)*

Tempered Glass Vented Doors



Perforated Doors



Side Panels

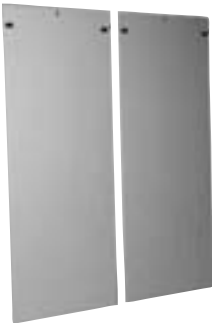

Description	Belden Part Number
Tempered Glass Vented Doors	
Tempered Glass Front/Rear Door with Latch and Lock, 78"	B7824-SVF-C
Tempered Glass Front/Rear Door with Latch and Lock, 84"	B8424-SVF-C
Perforated Door	
Perforated Front/Rear Door with Latch and Lock, 78"	B7824-SPR-C
Perforated Front/Rear Door with Latch and Lock, 84"	B8424-SPR-C

Side Panels

Single Side Panel

1-Solid Lift-off Side Panel with Lock, 78"	B7836-01-SP-C
1-Solid Lift-off Side Panel with Lock, 84"	B8436-01-SP-C

Pair of Side Panels

2-Solid Lift-off Side Panels with Lock, 78"	B7836-02-SP-C
2-Solid Lift-off Side Panels with Lock, 84"	B8436-02-SP-C

Removable Tops/Cooling Devices

Solid Top	B2430-TP-1-C
Solid Top with 10" Diameter Fan, 550 CFM	B2430-TP-3-C
Solid Top with (4) 4" Diameter Fans, Four Fans = 320 CFM	B2430-TP-4-C
Perforated Top	B2430-TP-6-C
19" Fan Tray	B9315-7200

These products are in the process of being assessed for RoHS compliance. Please check our Web Site for the most current RoHS status.

Solid Removable Top w/10" Fan



Solid Removable Top w/ (4) 4" Fans



19" Fan Tray



Modular Enclosures

Ultra Deep Server Enclosure

24" Wide x 42" Deep

BUSD-Style Ultra Deep Server Enclosure



Ultra Deep Server Enclosure

The Ultra Deep Server is a freestanding enclosure with a 24" wide x 42" deep footprint. The enclosure features numerous top and bottom entry points for easy configuration to match your needs and an anti-tip device to prevent the enclosure from tipping when servers and shelves are extended. Among the many features and benefits of this modular unit are:

- **Reversible Doors:** Spring-loaded hinges allow quick change of door swing.
- **Split Rear Doors:** French-style perforated rear doors maximize space between enclosures.
- **Lift-off Side Panels:** Flush surface lock fasteners permit quick disconnect and lift off.
- **Door and Side Panel Security:** Doors and side panels lock; handles are flush mounted.
- **Cable Access Top:** Features a 14.25" x 4" cable access rubber gland which helps prevent dust from entering the enclosure.
- **Tempered Safety Glass:** Strengthens door and its easy-to-clean, non-scratching, tinted bronze color enhances overall appearance.
- **Grounding kit Included.**

Frames



BUSD 84

These products are in the process of being assessed for RoHS compliance. Please check our Web Site for the most current RoHS status.

Modular Enclosures

Ultra Deep Server Enclosure

24" Wide x 42" Deep (continued)

Dimensions

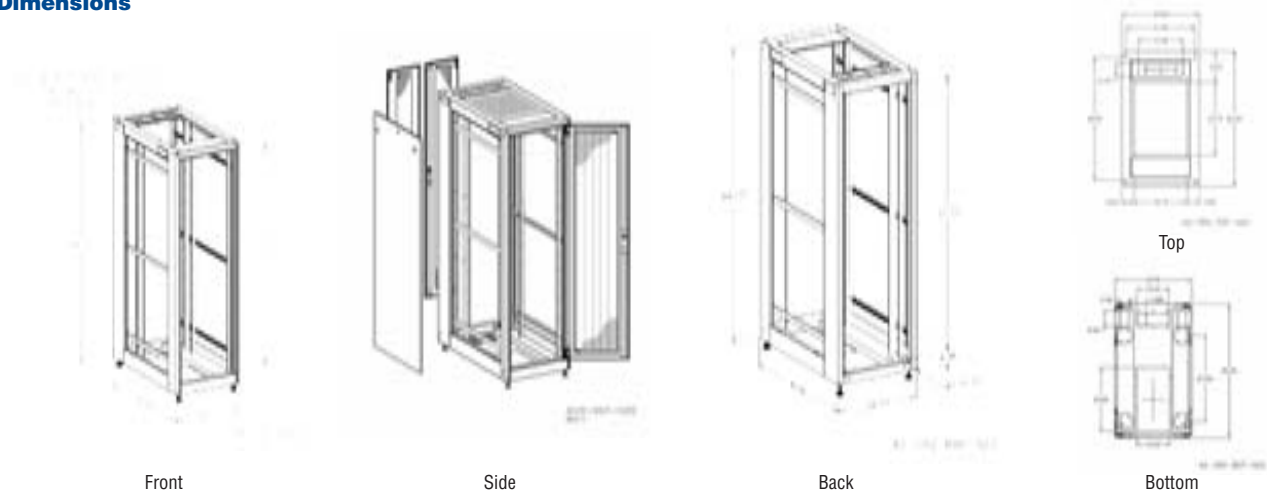

Technical Specifications

Enclosure Size	H	W	D	Weight	Mounting	Rack Spaces
BUSD84 Frame 3 pair 19" Mounting Rails, Casters, Levelers	84"	24"	42"	400 lb	19"	45U

EIA - 310 - D Compliant

Description	Belden Part Number
Ultra Deep 84" Black, 19" Mounting, 10" Fan Top, Front Rigid Perforated Door, Rear Split Perforated Door, Two Sides, 20 Amp Power Strip	BUSD84-3-122226
Ultra Deep 84" Black Frames w/19" Mounting	BUSD84-3-100000

How To Order

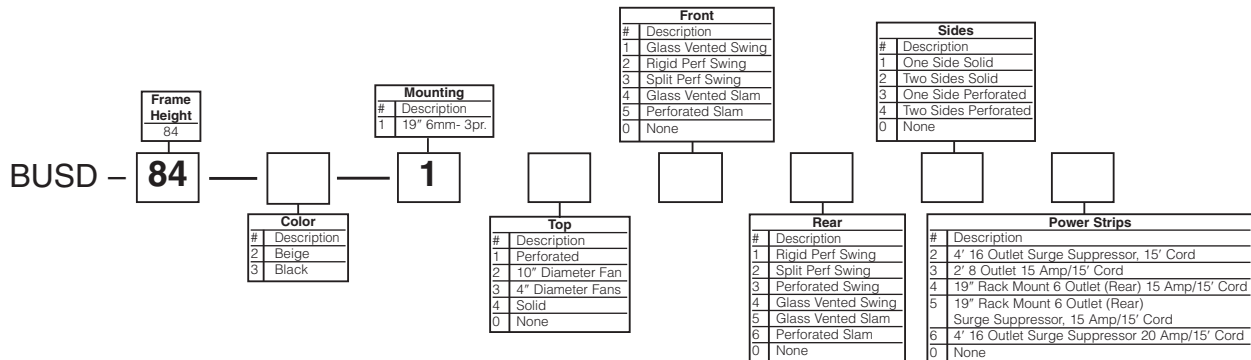

These products are in the process of being assessed for RoHS compliance. Please check our Web Site for the most current RoHS status.



For more information, contact Belden Technical Support: 1-800-BELDEN-1 • www.belden.com

Modular Enclosures

Ultra Deep Server Enclosure

24" Wide x 42" Deep (continued)

Tempered Glass Vented Doors



Perforated Doors



Side Panels



Description	Belden Part Number
Front Door	
Tempered Glass Front Door	
Tempered Glass Front (Vented) Door with Swing Handle, Latch and Lock	B8424-DSVF-C
Rigid Perforated Front Door	
Rigid Perforated Front Door with Swing Handle, Latch and Lock	B8424-DSPR-C
Rear Door	
Perforated Rear Door	
Split Door with Swing Handle, Latch and Lock	B8424-DSSR-C
Rigid Door with Swing Handle, Latch and Lock	B8424-DSPR-C
Door with Swing Handle, Latch and Lock	B8424-DSVR-C
Side Panels	
Single Side Panel	
1-Solid Lift-off Side Panel with Lock	B8436-01-SP-C
1-Perforated Lift-off Side Panel with Lock	B8436-01-SPP-C
Pair of Side Panels	
2-Solid Lift-off Side Panels with Lock	B8436-02-SP-C
2-Perforated Lift-off Side Panels with Lock	B8436-02-SPP-C
Removable Tops/Cooling Devices	
Solid Top	B2430-TP-1-C
Solid Top with 10" Diameter Fan, 550 CFM	B2430-TP-3-C
Solid Top with (4) 4" Diameter Fans, Four Fans = 320 CFM	B2430-TP-4-C
Perforated Top	B2430-TP-6-C
19" Fan Tray	B9315-7200
Cable Management Troughs	
76.5" Steel Vertical Cable Trough	B433-5114
Steel Front Horizontal Cable Trough	B433-5115-F
Steel Rear Horizontal Cable Trough	B433-5115-R
Steel Side Horizontal Cable Trough	B433-5118

These products are in the process of being assessed for RoHS compliance. Please check our Web Site for the most current RoHS status.

Solid Removable Top w/10" Fan



Solid Removable Top w/ (4) 4" Fans



19" Fan Tray



Modular Enclosures

Giga Server Enclosure

26" Wide x 42" Deep

BGS-Style Giga Server Enclosure



Giga Server Enclosure

The Giga Server is a freestanding enclosure with a 26" wide x 42" deep footprint. Each of the four corners of the enclosure has a built-in vertical cable channel. The unit's mounting rails have 19" EIA spacing to allow for cable management and different depths of equipment. Hinged cable access panels allow for large bundles of cable to be quickly routed from enclosure to enclosure or from the front of the enclosure to the rear of the enclosure. Among the many features and benefits of this modular unit are:

- **Reversible Door:** Spring-loaded hinges allow quick change of door swing.
- **Split Rear Doors:** French-style perforated rear doors maximize space between enclosures.
- **Lift-off Side Panels:** Flush surface lock fasteners permit quick disconnect lift off.
- **Door and Side Panel Security:** Doors and side panels lock; handles are flush mounted.
- **Integrated Cable Management.**
- **Grounding Kit included.**

Frames



BGS 84

These products are in the process of being assessed for RoHS compliance. Please check our Web Site for the most current RoHS status.

Modular Enclosures

Giga Server Enclosure
26" Wide x 42" Deep (continued)

Dimensions



Side

Technical Specifications

Enclosure Size	H	W	D	Weight	Mounting	Rack Spaces
BGS84 84" Frame, Three Pair 19" Mounting Rails, Casters, Levelers	84"	26"	42"	450 lb	19"	45U

Description	Belden Part Number
Giga Server 84" Black, 3-pair 19" Mounting, Perforated Top, Rigid Perforated Front, Split Fan Doors, Two Perforated Sides, 20 Amp Power Strip	BGS84-3-112346
Giga Server 84" Black, with 3-pair 19" Mounting	BGS84-3-100000

How To Order

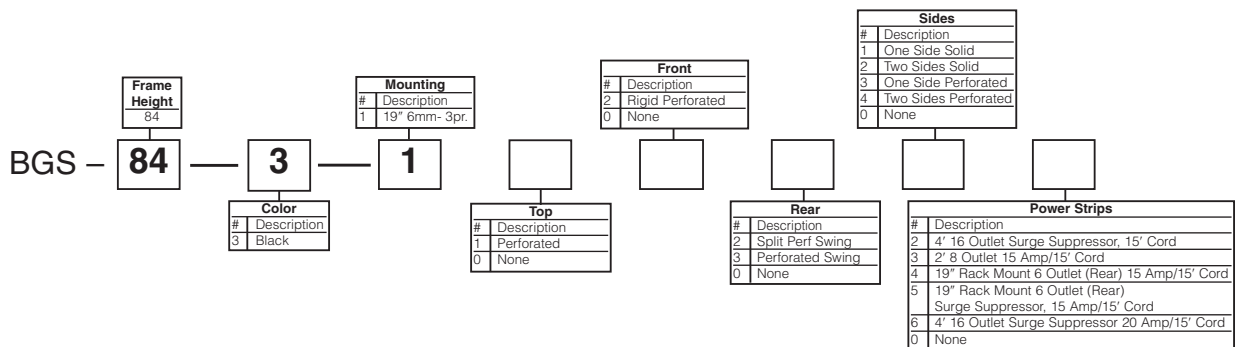

These products are in the process of being assessed for RoHS compliance. Please check our Web Site for the most current RoHS status.



For more information, contact Belden Technical Support: 1-800-BELDEN-1 • www.belden.com

Modular Enclosure Options and Accessories

Enclosure Shelves

B9010-1924

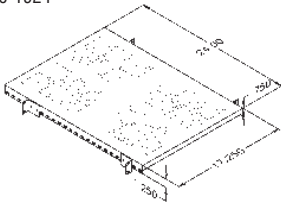

B9011-1918

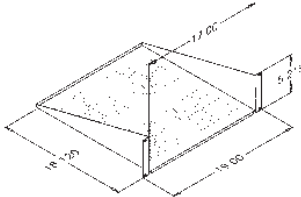

B9011-1918-16

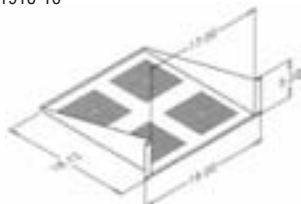

B9010-1930

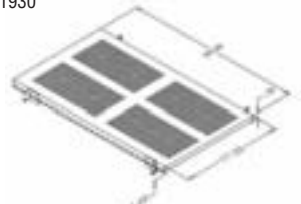

B9012-1918-16

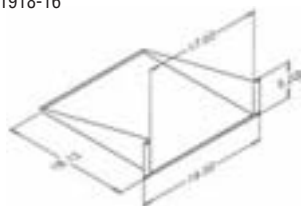

B9013-1936



B9012-1918

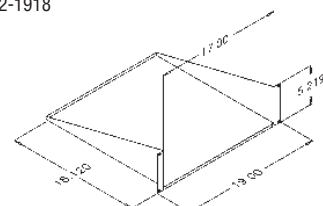

Enclosure Shelves

Modular Enclosure Shelves are available in widths of 19" and 23" with mounting depths of 24", 30" and 36". Load ratings range from 70 lbs up to 200 lbs. All shelves are black in color unless otherwise noted below.

Description	Belden Part Number
19" Shelves	
19" Heavy-Duty Adjustable Shelf (Vented)	
4 Point Mounting, 24" Depth, 150 lb Load Rating	B9010-1924
4 Point Mounting, 30" Depth, 150 lb Load Rating	B9010-1930
4 Point Mounting, 36" Depth, 150 lb Load Rating	B9010-1936
19" Flush Mount Cantilevered Shelf (Vented)	
12" Depth, Fits 24" Wall Mount, 70 lb Load Rating	B9011-1912
18" Depth, 75 lb Load Rating	B9011-1918
18" Depth, 50 lb Load Rating	B9011-1918-16
19" Flush Mount Cantilevered Shelf (Solid)	
18" Depth, 75 lb Load Rating	B9012-1918
18" Depth, 50 lb Load Rating	B9012-1918-16
19" Heavy Duty Sliding Adjustable Shelf (Vented)	
4 Point Mounting, 24" Depth, 200 lb Load Rating	B9015-1924
4 Point Mounting, 30" Depth, 100 lb Load Rating	B9013-1930
4 Point Mounting, 36" Depth, 100 lb Load Rating	B9013-1936
19" Keyboard Shelf (Fixed Front of Mounting Rail with Mouse Pad)	B9014-1907
19" Drawer, Monitor and Keyboard Shelf	B9015-1902
19" Sliding Rotating Keyboard Shelf	B9015-1909
19" Center Mount Shelf Kit (2-shelves)	
21" Depth, Aluminum, 100 lb Load Rating	B9016-1921
21" Depth, Black, 100 lb Load Rating	B9016-1921-3
19" Drawer, Utility, 4U, 16" Depth	B9017-0200
Pivot Cable Retractor	B9309-0100
19" Quick Disconnect Shelf	
6 mm Mounting Rails, 24" Depth, 200 lb Load Rating	B9010-1924-Q
6 mm Mounting Rails, 30" Depth, 200 lb Load Rating	B9010-1930-Q

These products are in the process of being assessed for RoHS compliance. Please check our Web Site for the most current RoHS status.

B9016-1921

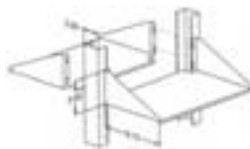

B9014-1907

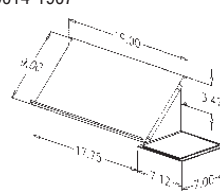

B9015-1909



B9010-1930-Q

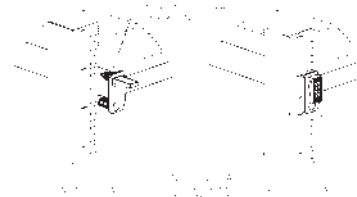
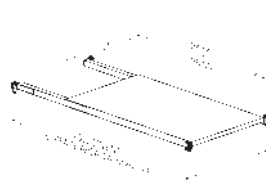

Modular Enclosure Options and Accessories

Enclosure Shelves (continued)

B9114-2307

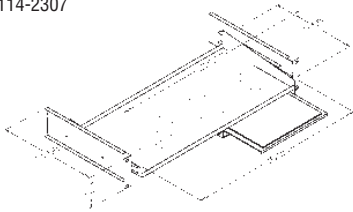

B9110-2324

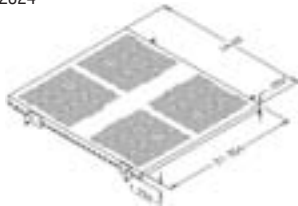

B9112-2318

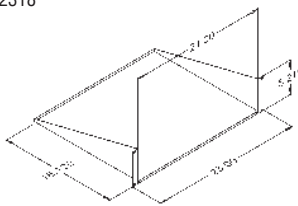

B9111-2318

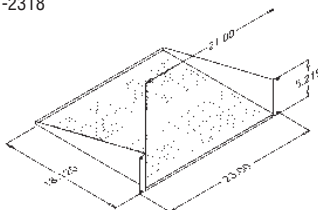

B9113-2324

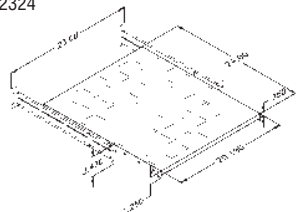

B9210-2923

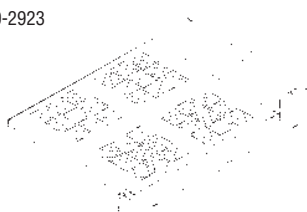

B9212-2922

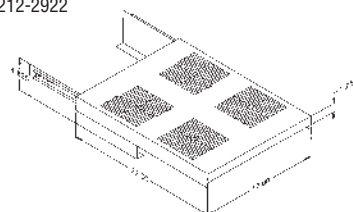

Description	Belden Part Number
23" Shelves	
23" Heavy Duty Adjustable Shelf (Vented) 4 Point Mounting, 180 lb Load Rating	B9110-2324
23" Flush Mount Cantilevered Shelf (Vented) 70 lb Load Rating	B9111-2318
23" Flush Mount Cantilevered Shelf (Solid) 70 lb Load Rating	B9112-2318
23" Heavy Duty Sliding Adjustable Shelf (Vented) 4 Point Mounting, 85 lb Load Rating	B9113-2324
23" Sliding Keyboard Shelf with Mouse Pad	B9114-2307

Frame Shelves

27.5" Wide Side Mount Shelf (Vented) 23.75" Depth, 180 lb Load Rating	B9210-2923
23.75" Depth, 90 lb Load Rating	B9211-2917
17" Wide Bottom Mount Sliding Server Shelf (Vented) 22" Depth, 100 lb Load Rating	B9212-2922

These products are in the process of being assessed for RoHS compliance. Please check our Web Site for the most current RoHS status.

B9211-2917

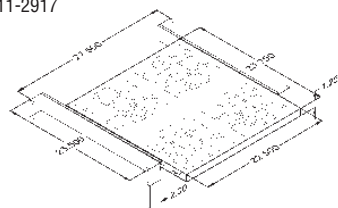

Modular Enclosure Options and Accessories

Anti-Tip, Grounding Bars, Mounting Hardware

BUS-ATD-0010



Enclosure Anti-Tip Device

The Data Standard, Data Slim, Data Deep and Ultra Deep Server Modular Enclosures are configured with an Anti-Tip Device which protects the enclosure from tipping when servers and shelves are extended.

Description	Belden Part Number
Anti-Tip Device for Ultra Deep Server	BUS-ATD-0010-C
Anti-Tip Device for Data Standard	BST-ATD-0030-3
Anti-Tip Device for Data Deep	BDP-ATD-0200-3
Anti-Tip Device for Data Slim	BSL/BST-ATD-0300-3

Grounding Bars

Copper grounding bars are available for mounting on any of the Enclosure types. Grounding bars are available for Vertical or Horizontal mounting.

Description	Belden Part Number
70" Vertical Isolated Copper Ground Bar, Tapped 10-32	B9714-0720
10" Horizontal Isolated Copper Ground Bar, Tapped 10-32	B9714-0190

B9714-0720



Enclosure Mounting Hardware

The Enclosure Mounting Hardware line includes a variety of bolts, screws and nuts for securing the enclosure.

Description	Belden Part Number
4, 5/16-18 Hex Head Bolt; 4, 5/16-18 Hex Nut; 8-5/16 Flat Washer	B8910-0100
10-32 Mounting Screws, Package of 50	B8911-0100
M6 Mounting Cagenut, Package of 50	B8913-0100
M6 Mounting Screw, Package of 50	B8914-0100
10-32 Mounting Hardware, 10-32 Floating Cagenut, Package of 50	B8915-0100

B9714-0190

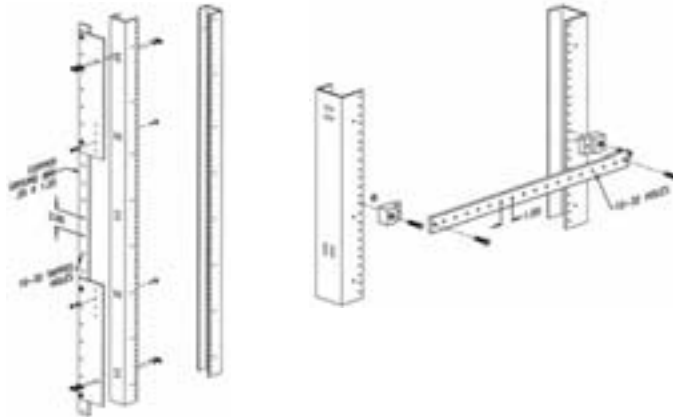

B8913-0100

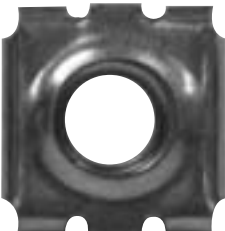

These products are in the process of being assessed for RoHS compliance. Please check our Web Site for the most current RoHS status.

Modular Enclosure Options and Accessories

Mounting Rails

Mounting Rails
Demonstrated in Enclosure



BRL-3024-0100



BRL-3012-0200



BRL-3006-0300



Enclosure Mounting Rails

The Enclosure Mounting Rail line includes 19" and 23" rails which are fully adjustable to accommodate different mounting depths.

Description	Belden Part Number
-------------	--------------------

Data Standard

Adjustable Mounting Rails 19" or 23"

Tapped 10-32, 48"	BST4819-23
Tapped 10-32, 72"	BST7219-23
Tapped 10-32, 78"	BST7819-23
Tapped 10-32, 84"	BST8419-23
6 mm with Hardware, 84"	BST8419-23SQ

Data Slim

Adjustable Mounting Rails 19" or 23"

Tapped 10-32, 72"	BSL7219
6 mm with Hardware, 72"	BSL7219SQ-2
Tapped 10-32, 78"	BSL7819
Tapped 10-32, 84"	BSL8419

Data Deep

Adjustable Mounting Rails 19" or 23"

Tapped 10-32, 72"	BDP7219-23
6 mm with Hardware, 72"	BDP7219-23SQ
Tapped 10-32, 78"	BDP7819-23
Tapped 10-32, 84"	BDP8419-23

Enclosure Partial Rail Kits

The Enclosure Partial Rail Kit line includes 6U, 12U and 24U rails for increased mounting flexibility.

Description	Belden Part Number
19" Partial Rail Kit (6U)	BRL-3006-0300
19" Partial Rail Kit (12U)	BRL-3012-0200
19" Partial Rail Kit (24U)	BRL-3024-0100

These products are in the process of being assessed for RoHS compliance. Please check our Web Site for the most current RoHS status.

Modular Enclosure Options and Accessories

Cable Management and Light Kits

B9713-0200

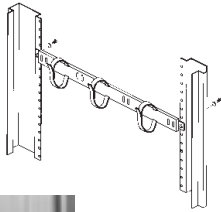

Horizontal: B9713-0200
Vertical: B9712-0100

Front to Rear Cable Management

Front to Rear Cable Management makes routing of cable neat, keeps them secure and manages bend radius.

Description	Belden Part Number
-------------	--------------------

Front to Rear Cable Management

w/3 Velcro Straps	B9713-0200
for 30" & 34" deep Enclosure 1" x 3" finger stock	B9713-0201
for 36" deep enclosure 1" x 3" finger stock	B9713-0202

Vertical Cable Management

Corner Mount Vertical Cable Management Ring 3" x 3" w/Velcro Strap	B9712-0100
Side Mount Cable Management 2.5" x 5.75"	B9712-0101
Front Mount Cable Management 1.5" x 3"	B9712-0102
1U Cable Manager 1" wide x 2" deep	B9712-0103
Mounting Rail Single M-Clip (XUSD)	B9712-0106
Mounting Rail Dual M-Clip (XUSD)	B9712-0107
Mounting Rail 84" Lacing Panel black (Data Standard, Data Slim, Data Deep)	B9712-0108
78" Lacing Panel black (Data Standard, Data Slim, Data Deep)	B9712-0109
78" Lacing Panel black (Ultra Server, Ultra Deep Server)	B9712-0109S

Light Kits

With dual adjustable 5 watt halogen lites & dimmer, UL Listed	B9420-1905
With single adjustable 5 watt halogen lite & dimmer, UL Listed	B9420-1906

These products are in the process of being assessed for RoHS compliance. Please check our Web Site for the most current RoHS status.

B9713-0201



B9713-0202



B9712-0100



B9712-0106



B9420-1905



B9712-0101

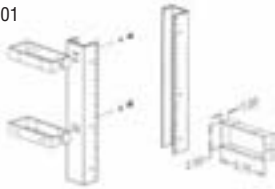

B9712-0108,
B9712-0109

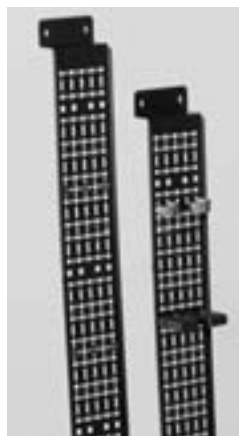

B9420-1906



B9712-0103



B9712-0102



B9712-0107



Modular Enclosure Options and Accessories

Enclosure Power Strips

Power Strips

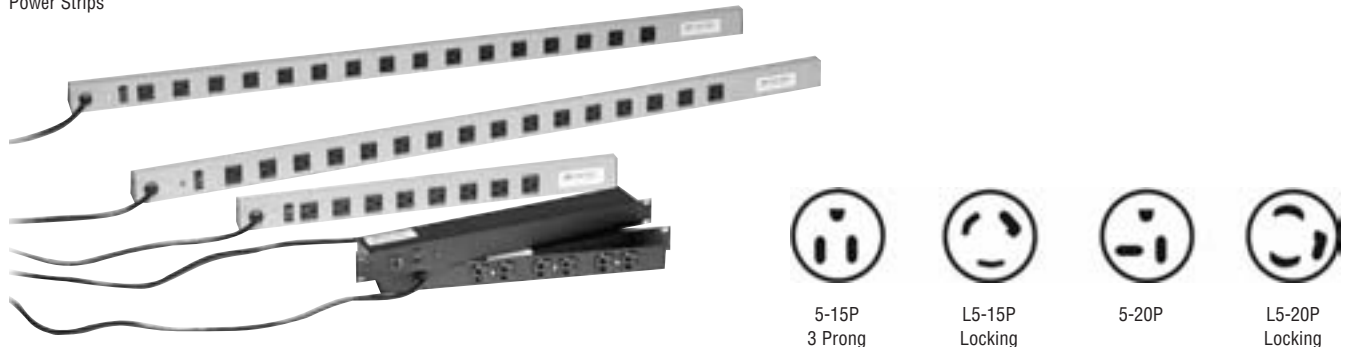

Technical Specifications

Part Number	Number of Outlets	Amps	Plug Type	Protection		Switch	Outlet Spacing	Volts	Receptacle Type	Cord Length
				Surge	Circuit					
B9411-1602	16	15	5-15P 3 Prong	Yes	Yes	Yes	2.500	120	5-15R	15 ft
B9412-0801	8	15	5-15P 3 Prong	No	Yes	Yes	2.000	125	5-15R	15 ft
B9413-0601	6	15	5-15P 3 Prong	No	Yes	Yes	1.50	125	5-15R	15 ft
B9414-0602	6	15	5-15P 3 Prong	Yes	Yes	Yes	1.50	125	5-15R	15 ft
B9415-1601	10	20	L5-20P Locking	No	Yes	Yes	4.300	120	5-15R	15 ft
B9415-1602	16	20	L5-20P Locking	No	Yes	Yes	2.500	120	5-15R	15 ft
B9415-1603	16	20	5-20P	No	Yes	Yes	2.430	120	5-15R	15 ft
B9415-1606	6	20	L5-20P Locking	No	Yes	Yes	2.650	120	5-15R	15 ft
B9415-1607	10	15	L5-15P Locking	No	Yes	Yes	4.25	120	5-15R	15 ft
B9415-1608	16	20	L5-20P Locking	No	No	No	2.735	120	5-15R	15 ft
B9415-1610	16	20	5-20P 3 Prong	Yes	Yes	No	2.25	125	5-20R	15 ft
B9416-1001	10	20	L5-20P Locking	No	Yes	Yes		120	5-15R	15 ft

Description	Belden Part Number
4' 16 Outlet Strip Surge Suppressor, 15' Power Cord, UL Listed	B9411-1602
2' 8 Outlet Strip, 15 Amp/15' Power Cord, UL Listed	B9412-0801
19" Rack Mount 6 Outlet Strip (Rear), 15 Amp/15' Power Cord, UL Listed	B9413-0601
19" Rack Mount 6 Outlet Strip (Rear) Surge, 15 Amp/15' Power Cord, UL Listed	B9414-0602
4' 10 Outlet Strip, 20 Amp/15' Power Cord w/Twist Lock Plug, UL Listed	B9415-1601
4' 16 Outlet Strip, 20 Amp/15' Power Cord w/Twist Lock Plug, UL Listed	B9415-1602
4' 16 Outlet Strip, 20 Amp/15' Power Cord, UL Listed	B9415-1603
6 Outlet Strip, 20 Amp/15' Power Cord w/Twist Lock Plug, UL Listed	B9415-1606
10 Outlet Strip, 15 Amp/15' Power Cord w/Twist Lock Plug, UL Listed	B9415-1607
4' 16 Outlet Strip, 20 Amp/15' Power Cord	B9415-1608
4' 16 Outlet Strip, 20 Amp Receptacle, Surge, CB, No Switch, 15' Cord, UL Listed	B9415-1610
19" Rack Mount 6 Outlet Front, 4 Outlet Rear, 20 Amp/15' Cord, w/Twist Lock Plug	B9416-1001

These products are in the process of being assessed for RoHS compliance. Please check our Web Site for the most current RoHS status.

Modular Enclosure Options and Accessories

Mission Critical Power Accessories

Mission Critical Power Accessory



Mission Critical Power Accessories

Slim-Line™ Low-Profile, Power Distribution, designed for high-density, mission critical server applications, the SL Series provides maximum power in a low profile chassis. Employing multiple configurations, the Easy-Read™ digital ammeter and clearly labeled circuits, SL Series assures easy management and monitoring for current requirements and future expansions.

- Datacenter grade receptacles
- 1.25" low profile
- Easy-Read digital ammeter

Dual-circuit, Vertical Power Distribution, designed for high-density, mission critical server applications, the DBVD Series provides dual-source in one vertical, power distribution unit. Employing multiple configurations, the Easy-Read digital ammeter and clearly labeled circuits, DBVD assures easy management and monitoring for current requirements and future expansions.

- High-density, dual source
- Side-by-side outlet configuration
- Easy-Read digital ammeter
- Clearly labeled circuits

Technical Specifications

Part Number	Circuit Type	Volts	Amps	Unit Length	Plug Type	Cord Length	Outlet Type	Qty.	Power (Watts)	Est. Server Qty.			Ammeter
										300W	400W	500W	
B9418-0801	Single	120	20	24"	Straight	15'	5-15/20	8	1920	10	8	6	Yes
B9418-0802	Single	120	20	24"	L5-20	15'	5-15/20	8	1920	10	8	6	Yes
B9418-1201	Single	120	20	60"	L5-20	15'	5-15/20	12	1920	10	8	6	Yes
B9418-2401	Single	120	30	60"	L5-30	15'	5-15/20	24	2880	15	12	9	No
B9418-2402	Dual	120	2 x 20	60"	2 x L5-20	15'	5-15/20	2 x 12	2 x 1920	10	8	6	No
B9418-2403	Dual	120	2 x 20	60"	L5-20	15'	5-15/20	2 x 12	2 x 1920	10	8	6	Yes
B9418-2410	Single	120	30	60"	L5-30	15'	5-15/20	24	2880	15	12	9	Yes
B9418-4801	Dual	208	2 x 30	68"	2 x L6-30	10'	C-13	2 x 24	2 x 4992	24	21	17	Yes
B9418-7201	Dual	208 3 phase	2 x 20	68"	2 x L21-20	10'	C-12	2 x 36	2 x 5757	32	24	19	Yes

Description	Belden Part Number
24" 8 Outlet 20 Amp Circuit, 120 Volt, Straight Plug, 15' Power Cord, with Ammeter, UL Listed	B9418-0801
24" 8 Outlet 20 Amp Circuit, 120 Volt, L-5 20 Plug, 15' Power Cord, with Ammeter, UL Listed	B9418-0802
60" 12 Outlet 20 Amp 120 Volt, L-5 20 Plug, 15' Power Cord with Ammeter, UL Listed	B9418-1201
60" 24 Outlet 30 Amp 120 Volt, L-5 30 Plug, 15' Power Cord, UL Listed	B9418-2401
60" Dual 12 Outlet, Dual 20 Amp Circuit, 120 Volt, Dual L-5 20 Plug, 15' Power Cord, UL Listed	B9418-2402
60" Dual 12 Outlet, Dual 20 Amp Circuit, 120 Volt, Single L-5 20 Plug, 15' Power Cord, with Ammeter, UL Listed	B9418-2403
60" 24 Outlet 30 Amp 120 Volt, L-5 30 Plug, 15' Power Cord, with Ammeter, UL Listed	B9418-2410
68" Dual 24 Outlet, Dual 30 Amp Circuit, Dual L-6 30 Plug, C-13 Outlets, 10' Power Cord, with Ammeter, UL Listed	B9418-4801
68" Dual 36 Outlet, Dual 20 Amp Circuit, Dual L-21 20 Plug, C-12 Outlets, 10' Power Cord, with Ammeter, UL Listed	B9418-7201

These products are in the process of being assessed for RoHS compliance. Please check our Web Site for the most current RoHS status.

Modular Enclosure Options and Accessories

Climate Monitors and Controllers

B9318-0400



Climate Monitor

Designed specifically for internal computer cabinet installation, this low-cost self-contained unit continually monitors climate via an internally-generated web page or SNMP. Values are graphed to see trends.

Its small size permits mounting in cabinet corners or the cabinet "attic" area and eliminates the environment monitor from occupying a 1-U space.

All software is contained inside the unit. The user supplies an Internet connection and an IP address. Administration of the unit is accomplished via the web page. When user-defined thresholds are exceeded, alarms can be sent via e-mail or SNMP trap.

A full set of internal sensors are included:

- Temperature
- Humidity
- Air Flow
- Light
- Sound

A variety of optional remote sensors are easily added. Up to 16 remote sensors can be added using Category 3 telephone wire and RJ-11 connectors. Remote sensors include:

- Web Cam
- Door Sensors
- Water Sensor
- Remote Temperature Sensor
- City Power Monitor
- In Line Power Monitoring

Remote sensors allow the unit to monitor up to 16 cabinets hundreds of feet apart and show the status of air-conditioning outputs. There is one remote RJ-11 sensor receptacle on the unit. Simple splitters are used to expand to use all 16 sensors.

Software protocols include:

- Web (HTTP)
- SMTP/POP
- SNMP (full MIB)
- FTP (firmware upgrades)
- Graphing
- PDA display format
- WAP (cell phone display)
- XML
- Excel™

The web cam used is an IP-based Axis 205; it can be installed locally or remotely.

Firmware updates can be made by FTP file transfer which eliminates retuning the unit to the factory.

B9318-0300



B9318-0200



Description	Belden Part Number
Climate monitor (Temperature, heat, humidity, airflow, sound)	B9318-0400

Electronic Fan Controller

- Remote temperature sensor with eight feet of cable allows mounting of controller in convenient location while precisely monitoring temperature at any point within the cabinet.
- Digital display shows actual temperature and programmed setpoint.
- Universal mounting bracket allows mounting to EIA rails or enclosure frame.
- Temperature range from -20°F (-29°C) to 140°F (60°C).

Description	Belden Part Number
Electronic Fan Controller	B9318-0300

Thermostat Fan Controller

- Low cost mechanical controller with Internal Bi-Metal sensing element.
- Position controller inside cabinet where temperature is to be monitored.
- Universal mounting bracket allows mounting to EIA rails or enclosure frame.
- Temperature range from -10°F (-23°C) to 100°F (38°C).

Description	Belden Part Number
Thermostat Fan Controller	B9318-0200

These products are in the process of being assessed for RoHS compliance. Please check our Web Site for the most current RoHS status.

Wall Mount Enclosures and Accessories

Wall Mount Enclosures

BWM 4820-GD



BWM 2406-SD



BWM 2420-SD

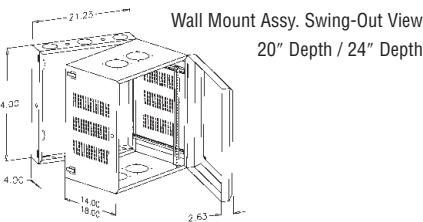

Wall Mount Assy. Swing-Out View
20" Depth / 24" Depth

Wall Mount Assy.
Rear Section
Mid Section
Front Door w/Glass

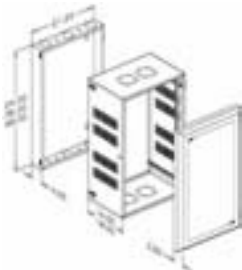

Wall Mount Assy. 4" Depth
Rear Section
Plywood Back Board (Opt.)
Front Door w/Glass

6" Depth

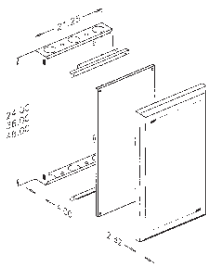

BWM-9312-1600 Fan Assembly
(2) 4" Diameter Fans (160 CFM) w/Guard



Wall Mount Enclosure

The Wall Mount Enclosure provides a secure and permanent location for a variety of components. Most units feature 19" mounting rails and are available with either a glass door with lock or a steel door with lock and 1 pair of 10-32 tapped rails. A 48" NEMA-12 model is also offered for harsh environments.

Description	Weight	Mounting	Belden Part Number
-------------	--------	----------	--------------------

Wall Mount Enclosure

24" Wall Mount Enclosure 6" Depth			
with Glass Door with Lock	40 lb	Back Board	BWM-2406-GD-C
with Steel Door with Lock	35 lb	Back Board	BWM-2406-SD-C
24" Wall Mount Enclosure 20" Depth			
with Glass Door with Lock	75 lb	12U	BWM-2420-GD-C
with Steel Door with Lock	70 lb	12U	BWM-2420-SD-C
24" Wall Mount Enclosure 24" Depth			
with Glass Door with Lock	80 lb	12U	BWM-2424-GD-C
with Steel Door with Lock	75 lb	12U	BWM-2424-SD-C
36" Wall Mount Enclosure 6" Depth			
with Glass Door with Lock	45 lb	Back Board	BWM-3606-GD-C
with Steel Door with Lock	45 lb	Back Board	BWM-3606-SD-C
36" Wall Mount Enclosure 20" Depth			
with Glass Door with Lock	90 lb	18U	BWM-3620-GD-C
with Steel Door with Lock	85 lb	18U	BWM-3620-SD-C
36" Wall Mount Enclosure 24" Depth			
with Glass Door with Lock	98 lb	18U	BWM-3624-GD-C
with Steel Door with Lock	95 lb	18U	BWM-3624-SD-C
48" Wall Mount Enclosure 6" Depth			
with Glass Door with Lock	75 lb	Back Board	BWM-4806-GD-C
with Steel Door with Lock	65 lb	Back Board	BWM-4806-SD-C
48" Wall Mount Enclosure 20" Depth			
with Glass Door with Lock	120 lb	25U	BWM-4820-GD-C
with Steel Door with Lock	110 lb	25U	BWM-4820-SD-C
48" Wall Mount Enclosure 24" Depth			
with Glass Door with Lock	135 lb	25U	BWM-4824-GD-C
with Steel Door with Lock	125 lb	25U	BWM-4824-SD-C
48" NEMA 12 Wall Mount Enclosure 24" Depth			
with Steel Door with Latch	205 lb	26U	BWM-4830-SD-3S0001

These products are in the process of being assessed for RoHS compliance. Please check our Web Site for the most current RoHS status.

NEMA 12

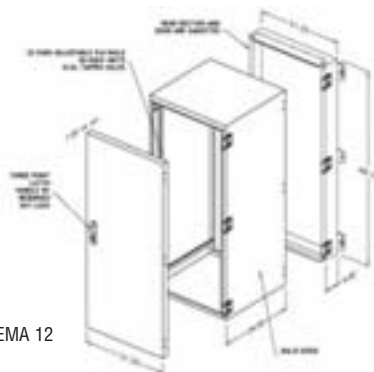

Wall Mount Enclosures and Accessories

Accessories and Swing Racks

Optional Basket

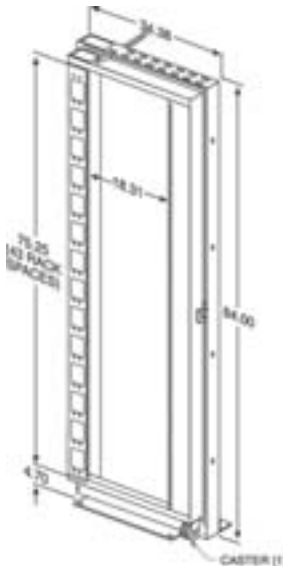

Wall Mount Enclosure Accessories

Description	Belden Part Number
Caster/Leveler Base	
Caster/Leveler Base, 20" or 24"	B8912-0200-C
Back Board	
24" Plywood Back Board (Black)	BWM-2401
36" Plywood Back Board (Black)	BWM-3601
48" Plywood Back Board (Black)	BWM-4801
Fan Assembly	
Fan Assembly (2) 4" Diameter Fans (160 CFM) with Guard	BWM-9312-1600
Mounting Uprights	
19" Mounting Uprights, 24"	BWM-2419
19" Mounting Uprights, 36"	BWM-3619
19" Mounting Uprights, 48"	BWM-4819

Swing Racks

The Swing Rack provides easy access to the rear of rack mounted equipment in a free-standing environment. It is ideal for applications where space is limited and rear access is essential.

Description	Weight	Mounting	Belden Part Number
84" Swing Out Distribution Rack	179 lb	34U	BSW-8419
Power Strip Mounting Kit (Sold Separately)			BSW-0100
Top Mounting Wire Basket (24" Long) (Sold Separately)			BSW-0200

Swing Racks

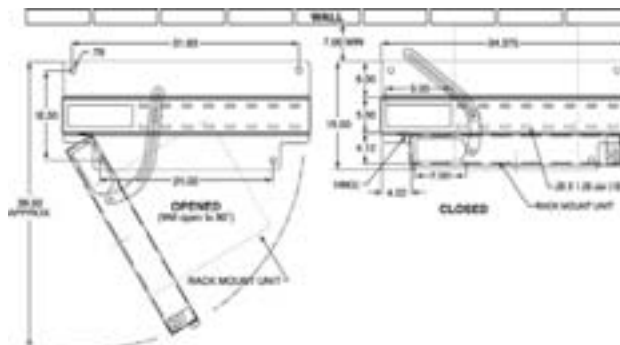

These products are in the process of being assessed for RoHS compliance. Please check our Web Site for the most current RoHS status.

Notes



Open Frame Racks and Accessories

12



Table of Contents

Open Frame Racks and Accessories	Page No.
Introduction	12.2
Open Frame Rack Kits & Accessories	12.3–12.4
Copper Rack Kit	12.3
Fiber Rack Kit	12.3
Floor Mount Rack	12.3
Distribution Racks	12.3
Vertical Cable Managers	12.3
Vertical Cable Management Channel	12.4
Horizontal Cable Management Channel	12.4
Cable Management Rack	12.4
Server Rack	12.4
Wall Mount Racks & Accessories	12.5
Accessories and Cable/Cord Management Units	12.6–12.7
Open Frame Rack Extender Brackets	12.6
Filler Panels	12.6
Patch Cord Organizers	12.6
Organizer Ring Panels	12.7
Organizer Trays	12.7
Brackets	12.7
Patch Cord Organizers	12.7
Cable Ties	12.8–12.10
Miniature: 18 Lbs Tensile Strength	12.8
Intermediate: 40 Lbs Tensile Strength	12.8
Standard: 50 Lbs Tensile Strength	12.8
Heavy Duty: 120 Lbs Tensile Strength	12.8
Heavy Duty: 175 Lbs Tensile Strength	12.9
Mount Ties	12.9
Marker Ties	12.9
Cable Tie Mounts	12.9
Velcro Cable Ties	12.10

Introduction

Belden: Resources Of a Higher Magnitude

Belden is the largest company of its kind, combining cable, connectivity, enclosures and many other product solutions for highly technical industries around the globe. As the exclusive occupant in this market position, Belden provides thousands of satisfied customers with over a billion dollars worth of trusted solutions every year, much of which supports the commercial networking sector. By combining our expertise in the design and manufacture of cable, connectivity, enclosures and related products, Belden now offers a product line of staggering magnitude, engineering triumphs and rich resources — worldwide.

Belden Open Frame Racks

The complete line of Belden Open Frame Racks are designed to meet the unique needs of data networks and other cabling systems. Whether it's the protection of sensitive equipment, the ability to mount equipment of varied sizes and depths, or the need to organize and neatly route installed cable, Belden has the solution you need. Belden provides you with single source convenience for all of your cable management requirements.

Enclosures and Racks

Choose from a variety of vertical enclosures, open frame racks and wall mount enclosures, all expertly engineered to optimize product quality and performance and manufactured in the United States for quick availability. Although standard configurations of the most popular enclosures are offered for fast delivery needs, all custom enclosures and racks have numerous mounting, cable and patch cord management options, along with a variety of accessories. This selection of Belden enclosures and racks will meet virtually any mounting, storage or protection requirement for your application.

Cable Ties

Belden cable ties are available in a complete variety of sizes for varying load capacities and are available in standard nylon or weather-resistant nylon.

Single Sourcing Convenience

The Cable Management product families in this catalog are offered to cabling professionals for ultimate convenience in single sourcing. As a Belden customer, you also have the assurance of total dependability by working with a market leader and a trusted partner who has a vested interest in optimizing your operations and investments. We want to make sure you not only get the products you need with ease, but they also perform reliably.

Cable Ties

Type	Tensile/Shear Strength	Length	Weather Resistant
Miniature	18 lbs.	4" or 8"	
Intermediate	40 lbs.	5 1/2" to 14 1/2"	●
Standard	50 lbs.	8" to 17 3/4"	●
Heavy Duty	120 lbs.	15"	
Heavy Duty	175 lbs.	17 3/4" to 48"	
Velcro	23 lbs./sq.in	8" or 12"	

Open Frame Racks

Type	Rack Space	Heights (inches)	Panel Mount (inches)	Width (inches)	Depth (inches)
Swing Rack	43U	84	19	34, 38	15
Distribution Rack	25, 39, 44U	48, 72, 84	19, 23	21.2, 25.2	21
Cable Management Rack	44U	84"	19	23.75, 25.75	15, 22
Copper Rack Kit	44U	84	19	30.75	14
Fiber Rack Kit	44U	84	19, 23	25, 29	14
Wall Mount Rack — Swing Out	19, 25U	36, 48	19	20	12 to 18
Wall Mount Rack — Hinged	2U, 4U, 6U	3.5, 7, 11	19	19, 19.5	4, 9.5



Open Frame Rack Kits & Accessories

Distribution Racks, Vertical Cable Managers

AX101174 Rack Kit

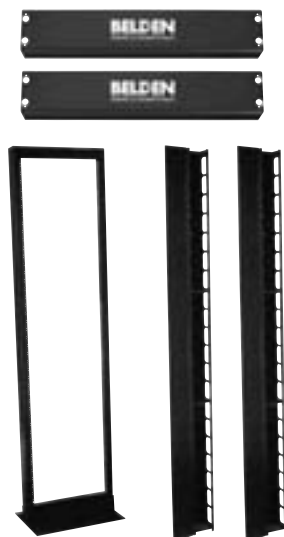

Open Frame Rack Kits

Rack Kits are offered for both copper and fiber cabling. Welded and knock-down rack assemblies are available for copper; knock-down rack kits are available for fiber. All units feature one rack with either one or two vertical and two horizontal channels.

Description	Mounting	Weight		Belden Part Number
		Lbs.	Kg	
Copper Rack Kit				
Welded Rack Assembly — Black, 19" x 84" (7') (One Rack w/ 2 Vertical & 2 Horizontal Channels)	44U	145	66	AX101174
Knock-Down Rack Assembly — Black, 19" x 84" (7') (One Rack w/ 2 Vertical & 2 Horizontal Channels)	44U	145	66	AX101175
Fiber Rack Kit				
Knock-Down Rack Assembly — Black, 19" x 84" (7') (One Rack with 1 Vertical & 2 Horizontal Channels)	44U	106	49	AX101176
Knock-Down Rack Assembly — Gray, 23" x 84" (7') (One Rack with 1 Vertical & 2 Horizontal Channels)	44U	113	52	AX101177
Floor Mount Rack				
Knock-Down Rack Assembly — Black, 19" x 84" (7') (w/ Two Horizontal Channels)	44U	65	30	AX101178
Knock-Down Rack Assembly — Gray, 19" x 84" (7') (w/ Two Horizontal Channels)	44U	65	30	AX101254
Knock-Down Rack Assembly — Black, 23" x 84" (7') (w/ Two Horizontal Channels)	44U	70	32	AX100931
Knock-Down Rack Assembly — Gray, 23" x 84" (7') (w/ Two Horizontal Channels)	44U	70	32	AX100930
Welded Rack Assembly — Black, 19" x 84" (7') (w/ Two Horizontal Channels)	44U	65	30	AX101179

BDR-Style Distribution Racks

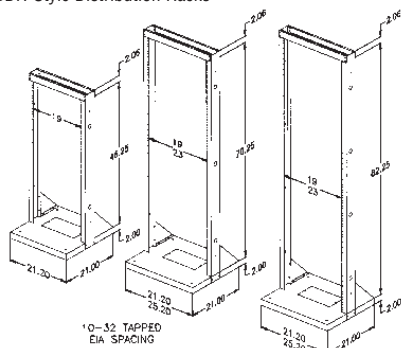

Distribution Racks

The Distribution Rack features 19" or 23" mounting rails for attaching a variety of rack mounted equipment. 48", 72" and 84" high models are included in the line.

Description	Mounting	Weight		Belden Part Number
		Lbs.	Kg	
48" Distribution Rack, 19" Mounting Rails	25U	34	15	BDR-4819
72" Distribution Rack, 19" Mounting Rails	39U	43	20	BDR-7219
84" Distribution Rack, 19" Mounting Rails	39U	50	23	BDR-8419
84" Distribution Rack, 19" Mounting Rails, 4" Channel with Angle Base, 12-24 EIA Spacing	45U	60	27	BDR-8419-4
72" Distribution Rack, 23" Mounting Rails	39U	45	20	BDR-7223
84" Distribution Rack, 23" Mounting Rails	45U	52	24	BDR-8423
Caster Kit for BDR Racks				B8912-0100

BDR-Style Vertical Cable Managers

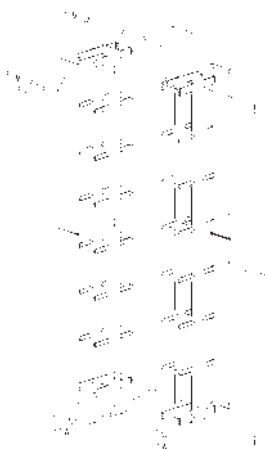

Vertical Cable Managers

The Vertical Cable Managers are used to manage patch cords in front and cables in the back. Available in 72" and 84" heights, the units are available with removable side panels and doors. They can be used with Distribution Racks (BDR-Style) and Rack Kit.

Description	Belden Part Number
72" Vertical Cable Manager	BDR-7201
84" Vertical Cable Manager	BDR-8401
84" Vertical Cable Manager, Double Sided with Cover	BDR-8403

These products are in the process of being assessed for RoHS compliance. Please check our Web Site for the most current RoHS status.

