

# Open Frame Rack Kits & Accessories

## Distribution Racks, Vertical Cable Managers

AX101174 Rack Kit

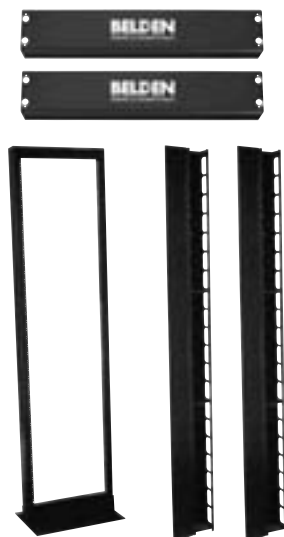

### Open Frame Rack Kits

Rack Kits are offered for both copper and fiber cabling. Welded and knock-down rack assemblies are available for copper; knock-down rack kits are available for fiber. All units feature one rack with either one or two vertical and two horizontal channels.

Description	Mounting	Weight		Belden Part Number
		Lbs.	Kg	
<b>Copper Rack Kit</b>				
Welded Rack Assembly — Black, 19" x 84" (7') (One Rack w/ 2 Vertical & 2 Horizontal Channels)	44U	145	66	<b>AX101174</b>
Knock-Down Rack Assembly — Black, 19" x 84" (7') (One Rack w/ 2 Vertical & 2 Horizontal Channels)	44U	145	66	<b>AX101175</b>
<b>Fiber Rack Kit</b>				
Knock-Down Rack Assembly — Black, 19" x 84" (7') (One Rack with 1 Vertical & 2 Horizontal Channels)	44U	106	49	<b>AX101176</b>
Knock-Down Rack Assembly — Gray, 23" x 84" (7') (One Rack with 1 Vertical & 2 Horizontal Channels)	44U	113	52	<b>AX101177</b>
<b>Floor Mount Rack</b>				
Knock-Down Rack Assembly — Black, 19" x 84" (7') (w/ Two Horizontal Channels)	44U	65	30	<b>AX101178</b>
Knock-Down Rack Assembly — Gray, 19" x 84" (7') (w/ Two Horizontal Channels)	44U	65	30	<b>AX101254</b>
Knock-Down Rack Assembly — Black, 23" x 84" (7') (w/ Two Horizontal Channels)	44U	70	32	<b>AX100931</b>
Knock-Down Rack Assembly — Gray, 23" x 84" (7') (w/ Two Horizontal Channels)	44U	70	32	<b>AX100930</b>
Welded Rack Assembly — Black, 19" x 84" (7') (w/ Two Horizontal Channels)	44U	65	30	<b>AX101179</b>

BDR-Style Distribution Racks

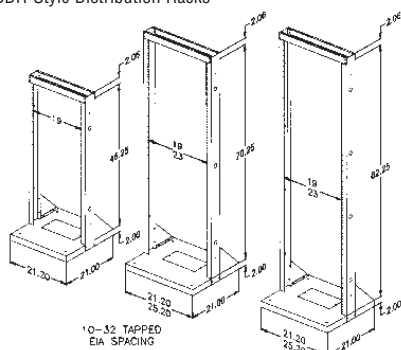

### Distribution Racks

The Distribution Rack features 19" or 23" mounting rails for attaching a variety of rack mounted equipment. 48", 72" and 84" high models are included in the line.

Description	Mounting	Weight		Belden Part Number
		Lbs.	Kg	
48" Distribution Rack, 19" Mounting Rails	25U	34	15	<b>BDR-4819</b>
72" Distribution Rack, 19" Mounting Rails	39U	43	20	<b>BDR-7219</b>
84" Distribution Rack, 19" Mounting Rails	39U	50	23	<b>BDR-8419</b>
84" Distribution Rack, 19" Mounting Rails, 4" Channel with Angle Base, 12-24 EIA Spacing	45U	60	27	<b>BDR-8419-4</b>
72" Distribution Rack, 23" Mounting Rails	39U	45	20	<b>BDR-7223</b>
84" Distribution Rack, 23" Mounting Rails	45U	52	24	<b>BDR-8423</b>
Caster Kit for BDR Racks				<b>B8912-0100</b>

BDR-Style Vertical Cable Managers

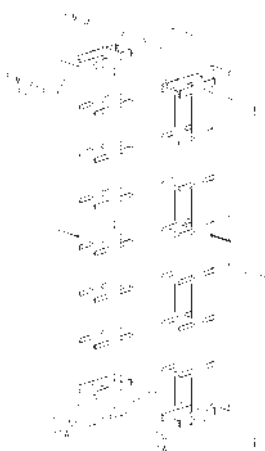

### Vertical Cable Managers

The Vertical Cable Managers are used to manage patch cords in front and cables in the back. Available in 72" and 84" heights, the units are available with removable side panels and doors. They can be used with Distribution Racks (BDR-Style) and Rack Kit.

Description	Belden Part Number
72" Vertical Cable Manager	<b>BDR-7201</b>
84" Vertical Cable Manager	<b>BDR-8401</b>
84" Vertical Cable Manager, Double Sided with Cover	<b>BDR-8403</b>

These products are in the process of being assessed for RoHS compliance. Please check our Web Site for the most current RoHS status.



# Open Frame Rack Kits & Accessories

Vertical and Horizontal Cable Management Channel, Cable Management Racks & Server Racks

AX101181 Horizontal Cable Management Channel



AX101180 Vertical Cable Management Channel



AX101371 Multi-Rack Attachment Spacer



## Vertical Cable Management Channel

Vertical Cable Management Channels are offered for both copper and fiber cabling. Available in heights of 84", the channels make cable organization quick and easy, with Swing Out/Removable doors.

Description	Weight		Belden Part Number
	Lbs.	Kg	
<b>Copper</b>			
Knock-Down Assembly — Black, 5" x 84" (7')	40	18	<b>AX101180</b>
<b>Fiber</b>			
Knock-Down Assembly — Gray, 5" x 84"	35	16	<b>AX100932</b>
Knock-Down Assembly — Black, 5" X 84"	35	16	<b>AX100933</b>
Multi-Rack Attachment (Spacer) Kit Use between Two Fiber Vertical Managers (AX100932-933)			<b>AX101371</b>

## Horizontal Cable Management Channel

Horizontal Cable Management Channels are available in widths of 19" and 23". The channels make cable organization quick and easy.

Description	Weight		Belden Part Number
	Lbs.	Kg	
19" Horizontal Cable Management Channel, Black	6	3	<b>AX101181</b>
19" Horizontal Cable Management Channel, Gray	6	3	<b>AX101182</b>
23" Horizontal Cable Management Channel, Black	8	4	<b>AX101184</b>
23" Horizontal Cable Management Channel, Gray	8	4	<b>AX101183</b>

BCR-8419 84" Cable Management Rack

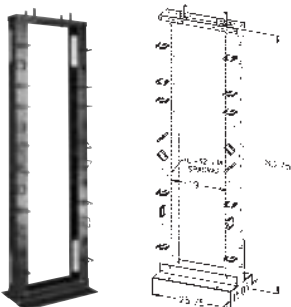

BCR-8419-10 84" Cable Management Rack w/ 10" Channel

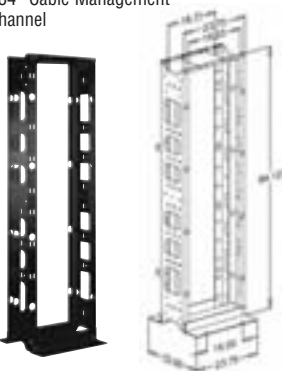

## Cable Management Rack

The Cable Management Racks are designed for 19" rack-mount equipment and are 84" high. Model BCR-8419-10 features a channel that can be adjusted up to 10" deep.

Description	Mounting	Weight		Belden Part Number
		Lbs.	Kg	
84" Cable Management Rack, 19" Mounting Rails	45	53	24	<b>BCR-8419</b>
84" Cable Management Rack, 19" Mounting Rails, 10" Channel with Cable Management	45	60	27	<b>BCR-8419-10</b>

BSR-8419 Server Rack

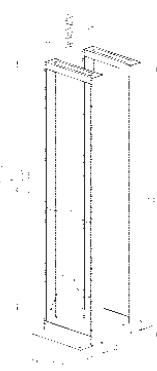

## Server Rack

Server Racks are designed for either 19" or 23" rack-mount equipment and are 84" high. The Server Rack is available in depths of 24", 28", 32" and 36" to accommodate different equipment needs.

Description	Belden Part Number
84" Four Post Server Rack, 19" Mounting, Depth 24"	<b>BSR-8419-24</b>
84" Four Post Server Rack, 19" Mounting, Depth 28"	<b>BSR-8419-28</b>
84" Four Post Server Rack, 19" Mounting, Depth 32"	<b>BSR-8419-32</b>
84" Four Post Server Rack, 19" Mounting, Depth 36"	<b>BSR-8419-36</b>
84" Four Post Server Rack, 23" Mounting, Depth 24"	<b>BSR-8423-24</b>
84" Four Post Server Rack, 23" Mounting, Depth 28"	<b>BSR-8423-28</b>
84" Four Post Server Rack, 23" Mounting, Depth 32"	<b>BSR-8423-32</b>
84" Four Post Server Rack, 23" Mounting, Depth 36"	<b>BSR-8423-36</b>

These products are in the process of being assessed for RoHS compliance. Please check our Web Site for the most current RoHS status.



# Wall Mount Racks & Accessories

BWR-3619

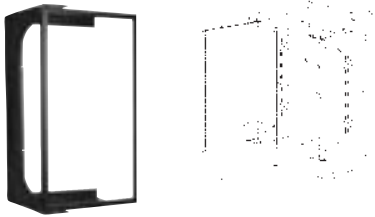

BWR-4819 — Swing out Distribution Racks  
19" x 48" Depth Range 11.5" to 15.5"

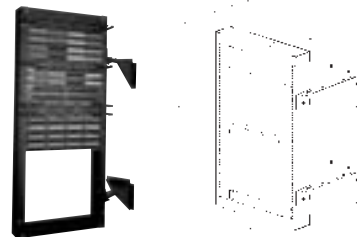

AX100785 Wall Mount Bracket, 2U



BWR-1219 — 12" Wall Mount Rack  
Hinged mounting for easy access

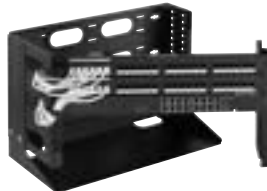

Adjustable shelf 2" - 6"

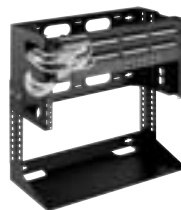

AX102514 — 4U Wall Mount Bracket w/2U Swivel



BER-6X6 — 6U Wall Mount Rack w/6U and 6U Front



## Wall Mount Racks

Wall Mount Racks are available in two styles: hinged and swing out. The hinged rack is 12" in height and features an adjustable lower shelf. The swing out rack is available in heights of 36" and 48" with 19" mounting rails. 2U, 4U and 6U Wall Mount Racks are also offered.

Description	Mounting	Weight		Belden Part Number
		Lbs.	Kg	
<b>Swing Out Rack</b>				
36" Wall Mount Swing Out Rack, 19" Mounting Rails x 12" Fixed Depth	18U	30	14	<b>BWR-3619-12</b>
36" Wall Mount Swing Out Rack, 19" Mounting Rails x 18" Depth	18U	30	14	<b>BWR-3619-18</b>
48" Wall Mount Swing Out Rack, 19" Mounting Rails, 11.5-15.5" Adjustable Depth	25U	39	18	<b>BWR-4819</b>
48" Wall Mount Swing Out Rack, 19" Mounting Rails x 12" Fixed Depth	25U	39	18	<b>BWR-4819-12</b>
48" Mount Swing Out Rack, 19" Mounting Rails x 18" Depth	25U	39	18	<b>BWR-4819-18</b>
<b>Hinged Rack</b>				
12" Wall Mount Rack, Hinged 19" Mounting Rails x 9" Fixed Depth	6U	26	12	<b>BWR-1219</b>
<b>Wall Mount Bracket</b>				
2U Wall Mount Bracket, Black	2U	4	2	<b>AX100785</b>
4U Wall Mount Bracket, Black	4U	8	4	<b>AX100786</b>
4U Wall Mount Bracket w/ 2U Swivel				<b>AX102514</b>
<b>6U Wall Mount Rack</b>				
6U Wall Mount Rack with 6U Top and 6U Front Rack Space, Tapped 12-24 EIA	6"	17	8	<b>BER-6X6</b>
Bottom Accessory Shelf				<b>BER-AS</b>
Front Mounted Swing-out Patch Panel Kit, 6U				<b>BER-6UP</b>
Single, 3U Space Top Dust Cover				<b>BER-3UC</b>

These products are in the process of being assessed for RoHS compliance. Please check our Web Site for the most current RoHS status.

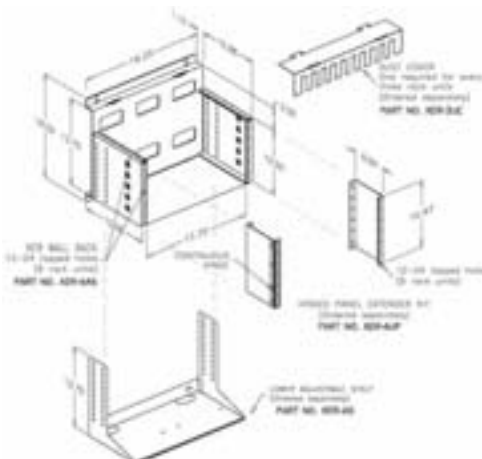

# Open Frame Rack Accessories & Cable/Cord Management Units

Extender Brackets, Filler Panels, Patch Cord Organizers

Rack Extenders



19" Filler Panels

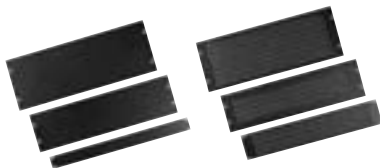

B9511-1902

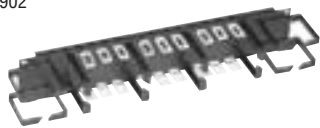

B9510-1901



B9512-1901



Top: B9512-1902  
Bottom: B9512-1902

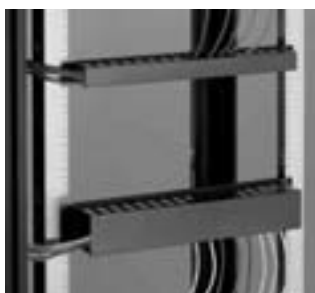

## Open Frame Rack Extender Brackets

The Open Frame Rack Extender Brackets are used to extend a 19" Panel/Equipment Mounting for 23".

Description	Belden Part Number
1U 23" EIA To 19" EIA Extender Bracket	<b>B9810-0100</b>
2U 23" EIA To 19" EIA Extender Bracket	<b>B9811-0200</b>
3U 23" EIA To 19" EIA Extender Bracket	<b>B9812-0300</b>
4U 23" EIA To 19" EIA Extender Bracket	<b>B9813-0400</b>

## Filler Panels

Filler Panels are available in solid or vented for improved air flow.

Description	Belden Part Number
1U 19" Solid Filler Panel, Gray	<b>A0644497</b>
2U 19" Solid Filler Panel, Gray	<b>A0644499</b>
1U 19" Solid Filler Panel, Black	<b>B9910-0100</b>
2U 19" Solid Filler Panel, Black	<b>B9911-0200</b>
3U 19" Solid Filler Panel, Black	<b>B9912-0300</b>
4U 19" Solid Filler Panel, Black	<b>B9913-0400</b>
2U 19" Vented Filler Panel, Black	<b>B9914-0200</b>
3U 19" Vented Filler Panel, Black	<b>B9915-0300</b>
4U 19" Vented Filler Panel, Black	<b>B9916-0400</b>

## Patch Cord Organizers

The Patch Cord Organizers keep wires and cable under control. Among the many features of the Patch Cord Organizers are:

- Horizontal / Vertical Patch Cord Management
- Front / Rear Management
- Removable Covers
- Bend Radius Control

Description	Belden Part Number
1U 19" Cable Organizer	<b>B9510-1901</b>
2U 19" Cable Organizer with Saddle Rings	<b>B9511-1902</b>
1U 19" Rack Mount Cable Organizer with Finger Stock and Cover (1.5" x 2")	<b>B9512-1901</b>
2U 19" Rack Mount Cable Organizer with Finger Stock and Cover (3" x 3")	<b>B9512-1902</b>
2U 19" Cable Organizer with Finger Stock and Cover Front and Rear	<b>B9512-1902-FR</b>
2U 19" Cable Organizer with Quick Touch (2" X 3")	<b>B9513-1902</b>
1U 19" Cable Organizer with Radius (Waterfall)	<b>B9514-1901</b>
1U 23" Cable Organizer	<b>B9610-2301</b>
2U 23" Cable Organizer with Saddle Rings	<b>B9611-2302</b>

These products are in the process of being assessed for RoHS compliance. Please check our Web Site for the most current RoHS status.



## Open Frame Rack Accessories & Cable/Cord Management Units

### Ring Panels, Organizer Trays, Brackets & Patch Cord Channel

AX100249 Organizer Tray, 3U



AX100463 Rear Cable Bracket

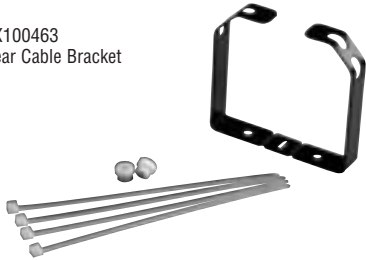

AX101173 Cable Tie Bar



AX100789 Cable Support Bracket



AX100793 Patch Cord Organizer Channel



A0396695 Organizer Ring Panel, 2U



A0644488 Organizer Panel, 1U



### Open Frame Rack Cable and Patch Cord Management

The Open Frame Rack Cable and Patch Cord Management accessories can be used with patch panels in open frame racks for distribution cable and patch cord organization, routing and protection. They allow easier cord access and simplify moves, additions and changes.

Description	Mounting	Belden Part Number
Organizer Ring Panel, Gray	2U	A0396695
Organizer Ring Panel, Black	2U	A0403977
Organizer Panel, Gray	1U	A0644488
Organizer Panel, Black	1U	A0644489
Organizer Panel, Gray	2U	A0644490
Organizer Panel, Black	2U	A0644492
Organizer Tray, Gray	3U	AX100248
Organizer Tray, Black	3U	AX100249
Rear Cable Bracket, Gray		AX100462
Rear Cable Bracket, Black		AX100463
Cable Support Bracket, Gray	0U	AX100788
Cable Support Bracket, Black	0U	AX100789
Patch Cord Organizer Channel, Gray	1U	AX100792
Patch Cord Organizer Channel, Black	1U	AX100793
Patch Cord Organizer Channel, Gray	2U	AX100794
Patch Cord Organizer Channel, Black	2U	AX100795
Patch Cord Organizer Channel, Gray	4U	AX100796
Patch Cord Organizer Channel, Black	4U	AX100797
Cable Tie Bar, Black	0U	AX101173

These products are in the process of being assessed for RoHS compliance. Please check our Web Site for the most current RoHS status.

## Cable Ties

Miniature, Intermediate, Standard & Heavy-Duty

CTM4018N  
Cable Ties



CTM4018B  
Cable Ties



### Cable Ties

The Cable Ties line features miniature, intermediate, standard and heavy duty cable ties. They are available in tensile strengths ranging from 18 to 175 lbs. and are manufactured from various grades of nylon including weather-resistant nylon for use in sunshine/outdoor applications. They are offered in lengths from 4" to 48". Color: Natural (indoor), Black (outdoor). Velcro Cable Ties are also available.

Description	Length		Width		Loop Tensile Strength		Max. Bundled Diameter		Belden Part No.
	in.	mm	in.	mm	Lbs.	N	in.	mm	
<b>Miniature 18 Lbs Tensile Strength</b>									
Nylon Cable Tie, 100 Pcs, Natural, 4"	3.9	100	0.098	2.5	18	80	1.0	25	CTM4018N
Nylon Cable Tie, 100 Pcs, Natural, 5.5"	5.6	142	0.098	2.5	18	80	1.4	35	CTM5P18N
Nylon Cable Tie, 100 Pcs, Natural, 8"	8.0	203	0.098	2.5	18	80	2.2	55	CTM8018N
<b>Intermediate 40 Lbs Tensile Strength</b>									
Nylon Cable Tie, 100 Pcs, Natural, 5.5"	5.6	142	0.125	3.2	40	178	1.4	35	CTI5P40N
Nylon Cable Tie, 100 Pcs, Natural, 8"	8.0	203	0.141	3.6	40	178	2.2	55	CTI8040N
Nylon Cable Tie, 100 Pcs, Natural, 11"	11.5	292	0.141	3.6	40	178	3.3	85	CTI11P40N
Nylon Cable Tie, 100 Pcs, Natural, 14.5"	14.5	368	0.141	3.6	40	178	4.0	103	CTI14P40N
Weather Resistant Nylon Cable Tie, 100 Pcs, Black, 5.5"	5.6	142	0.125	3.2	40	178	1.4	35	CTI5P40BW
Weather Resistant Nylon Cable Tie, 100 Pcs, Black, 8"	8.0	203	0.141	3.6	40	178	2.2	55	CTI8040BW
Weather Resistant Nylon Cable Tie, 100 Pcs, Black, 11.5"	11.5	292	0.141	3.6	40	178	3.3	85	CTI11P40BW
Weather Resistant Nylon Cable Tie, 100 Pcs, Black, 14.5"	14.5	368	0.141	3.6	40	178	4.0	103	CTI14P40BW
<b>Standard 50 Lbs Tensile Strength</b>									
Nylon Cable Tie, 100 Pcs, Natural, 8"	8.0	203	0.180	4.6	50	222	2.2	55	CTS8050N
Nylon Cable Tie, 100 Pcs, Natural, 11"	11.0	280	0.188	4.8	50	222	3.2	81	CTS1150N
Nylon Cable Tie, 100 Pcs, Natural, 14.5"	14.5	368	0.188	4.8	50	222	4.0	103	CTS14P50N
Nylon Cable Tie, 100 Pcs, Natural, 17.75"	17.7	450	0.188	4.8	50	222	5.1	131	CTS17P50N
Weather Resistant Nylon Cable Tie, 100 Pcs, Black, 8"	8.0	203	0.180	4.6	50	222	2.2	55	CTS8050BW
Weather Resistant Nylon Cable Tie, 100 Pcs, Black, 11.5"	11.0	280	0.188	4.8	50	222	3.2	81	CTS1150BW
Weather Resistant Nylon Cable Tie, 100 Pcs, Black, 14.5"	14.5	368	0.188	4.8	50	222	4.0	103	CTS14P50BW
Weather Resistant Nylon Cable Tie, 100 Pcs, Black, 17.75"	17.7	450	0.188	4.8	50	222	5.1	131	CTS17P50BW
<b>Heavy Duty 120 Lbs Tensile Strength</b>									
Nylon Cable Tie, 100 Pcs, Natural, 15"	15.0	380	0.298	7.6	120	533	4.3	111	CTH15120N

These products are in the process of being assessed for RoHS compliance. Please check our Web Site for the most current RoHS status.

# Cable Ties

## Marker Ties, Cable Tie Mounts

Marker Ties

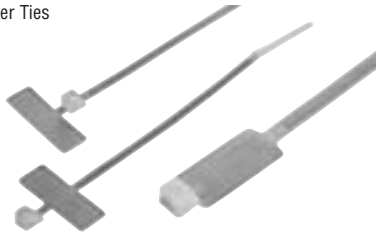

Description	Length		Width		Loop Tensile Strength		Max. Bundled Diameter		Belden Part No.	
	in.	mm	in.	mm	Lbs.	N	in.	mm		
<b>Heavy Duty Nylon Cable Tie</b> (175 Lbs Tensile Strength)										
100 pcs, Natural, 17.75"	17.7	450	0.313	8.0	175	778	5.2	134	<b>CTH17P175N</b>	
100 pcs, Natural, 21.7"	21.7	550	0.313	8.0	175	778	6.5	167	<b>CTH21P175N</b>	
100 pcs, Natural, 36"	36.0	914	0.352	9.0	175	778	10.6	271	<b>CTH36P175N</b>	
100 pcs, Natural, 48"	48.0	1219	0.352	9.0	175	778	15.0	382	<b>CTH48P175N</b>	
<b>Mount Ties</b>										
100 pcs, Natural, 40 lb, 6"	6.7	171	0.145	3.7	40	178	1.6	40	<b>CTI6040NM</b>	
100 pcs, Natural, 50 lb, 11.75"	11.8	300	0.188	4.8	50	222	3.3	85	<b>CTS11P50NM</b>	
100 pcs, Natural, 50 lb, 14.5"	14.6	370	0.188	4.8	50	222	4.0	103	<b>CTS14P50NM</b>	

Cable Tie Mounts

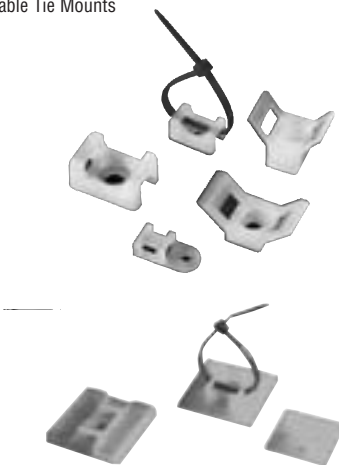

Description	Length		Width		Loop Tensile Strength		Max. Bundled Diameter		Marking Pad		Belden Part No.
	in.	mm	in.	mm	Lbs.	N	in.	mm	in.	mm	
<b>Marker Ties</b> (18 Lbs Tensile Strength)											
100 pcs, Natural, 4"	3.9	100	0.098	2.5	18	80	1.0	25	0.98 x 0.31	25 x 8	<b>CTM4018NMK</b>
100 pcs, Natural, 4.25"	4.3	110	0.098	2.5	18	80	1.0	25	0.98 x 0.32	26 x 8	<b>CTM4P18NMK</b>
100 pcs, Natural, 5"	5.1	130	0.098	2.5	18	80	1.0	25	1.10 x 0.79	28 x 20	<b>CTM5018NMK</b>
100 pcs, Natural, 8"	7.9	200	0.098	2.5	18	80	2.0	50	1.18 x 0.59	30 x 15	<b>CTM8018NMK</b>
<b>Marker Ties</b> (50 Lbs Tensile Strength)											
100 pcs, Natural, 8"	7.9	200	0.180	4.6	50	222	2.0	50	1.10 x 0.51	28 x 13	<b>CTS8050NMK</b>
100 pcs, Natural, 10.5"	10.6	270	0.180	4.6	50	222	3.0	75	1.10 x 0.51	28 x 13	<b>CTS10P50NMK</b>

Mount Ties

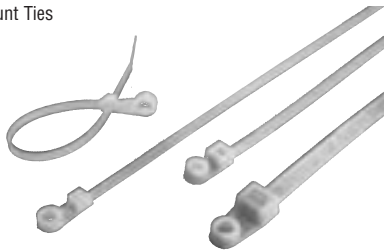

Description	Length		Width		Mounting Method	Belden Part No.
	in.	mm	in.	mm		
<b>Cable Tie Mounts</b>						
Cable Tie Mount S.A. M, 100 per bag	0.49	12.5	0.49	12.5	Self Adhesive	<b>TM100S4</b>
Cable Tie Mount S.A. M-I, 100 per bag	0.75	19.0	0.74	19.0	#4 M2.5 Screw + Self Adhesive	<b>TM101SS2</b>
Cable Tie Mount S.A. M-I-S, 100 per bag	1.10	28.0	1.10	28.0	#4 M2.5 Screw + Self Adhesive	<b>TM102</b>
Cable Tie Mount Sc. M-I, 100 per bag	0.50	12.8	0.27	7.0	#4 M2.5 Screw	<b>TM1</b>
Cable Tie Mount Sc. I-S-HD, 100 per bag	0.91	23.0	0.63	16.0	1/4 M6 Screw	<b>TM2</b>
Cable Tie Mount Sc. I-S-HD, 100 per bag	1.18	30.0	0.58	14.7	#10 M5 Screw	<b>TM4</b>

Cable mounts compatible with following cable tie cross section.

S.A. = Self Adhesive      M = Miniature  
 Sc. = Screw on type      I = Intermediate  
    S = Standard  
    HD = Heavy Duty

These products are in the process of being assessed for RoHS compliance. Please check our Web Site for the most current RoHS status.



For more information, contact Belden Technical Support: 1-800-BELDEN-1 • www.belden.com

## Cable Ties

### Velcro Ties, Saddles, Saddle Ties

AX100781  
Velcro Saddle



AX102512  
Saddle Tie

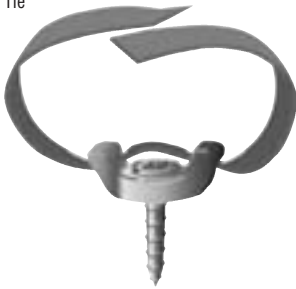

AX102516  
12" Fiber Optic Cable Manager



Description	Belden Part Number
<b>Velcro Cable Ties</b>	
Velcro Cable Ties, 25 per Roll, 8"	<b>AX100783</b>
Velcro Cable Ties, 25 per Roll, 12"	<b>AX100784</b>
Velcro Saddle, 25 pcs	<b>AX100781</b>
Velcro Saddle Kit with #8 Wood Screw, 10 pcs	<b>AX102512</b>
Velcro Saddle Kit with 10/32 Rack Screw, 10 pcs	<b>AX102513</b>
15' Roll x 5/8" Polywrap, Cut to length as required	<b>AX102515</b>
12" Fiber Optic Cable Manager	<b>AX102516</b>
24" Fiber Optic Cable Manager	<b>AX102517</b>

These products are in the process of being assessed for RoHS compliance. Please check our Web Site for the most current RoHS status.