

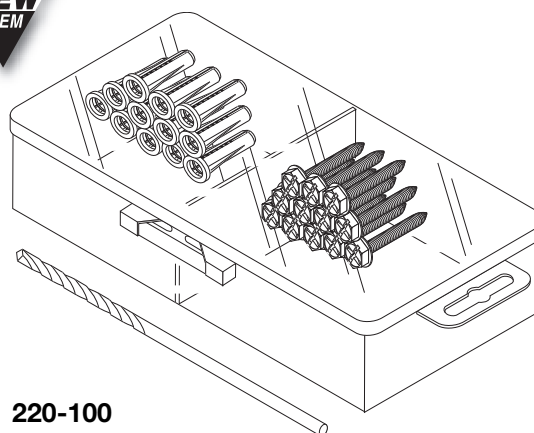

**Anchor Kit**

- 220-100** Anchor Kit with Anchors, Screws, Bit ◀ **NEW**  
Clear Plastic Container with Clasp Closure  
Cut-out Handle for Pegboard Hanging  
100 pcs. 8-10 x 1" Mounting Anchors  
100 pcs. #8 Steel Mounting Screws  
1 pc. 1/4" Masonry Drill Bit  
6 5/16" (W) x 3 3/8" (H) x 1 1/2" (D)



**220-100**

**Hex Head Mounting Screws**

- 220-110** 1/4" x 1 1/2" Hex Head Lag Screw ◀ **NEW**  
**220-115** 1/4" x 2" Hex Head Lag Screw ◀ **NEW**  
**220-120** 1/4" x 2 1/2" Hex Head Lag Screw ◀ **NEW**  
**220-125** 1/4" x 3" Hex Head Lag Screw ◀ **NEW**  
**220-210** 5/16" x 1 1/2" Hex Head Lag Screw ◀ **NEW**  
**220-215** 5/16" x 2" Hex Head Lag Screw ◀ **NEW**  
**220-220** 5/16" x 2 1/2" Hex Head Lag Screw ◀ **NEW**  
**220-225** 5/16" x 3" Hex Head Lag Screw ◀ **NEW**  
**220-322** 1" x 1 1/2" Hex Head Sheet Metal Screw ◀ **NEW**  
**220-425** 1/4" - 20 3" Phillips Panhead Screw ◀ **NEW**

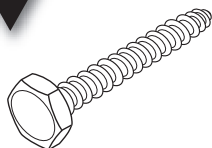

**220-110** 1/4" x 1 1/2"  
**220-115** 1/4" x 2"  
**220-120** 1/4" x 2 1/2"  
**220-125** 1/4" x 3"

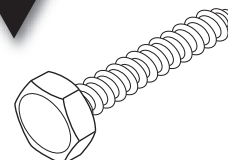

**220-210** 5/16" x 1 1/2"  
**220-215** 5/16" x 2"  
**220-220** 5/16" x 2 1/2"  
**220-225** 5/16" x 3"

**Mounting Anchors**

- 220-500** Lead Double Expansion Anchor 1/4" ◀ **NEW**  
Use 1/2" Drill Bit  
**220-510** Plastic Mounting Anchor 10-12 x 1" ◀ **NEW**  
Use 1/4" Drill Bit  
**220-515** Plastic Mounting Anchor 6-8 x 1" ◀ **NEW**  
Use 3/16" Drill Bit  
**220-520** Plastic Mounting Anchor 1/4" x 2 1/2" ◀ **NEW**  
Use 5/16" Drill Bit  
**220-525** Plastic Mounting Anchor 1/4" x 3" ◀ **NEW**  
Use 5/16" Drill Bit

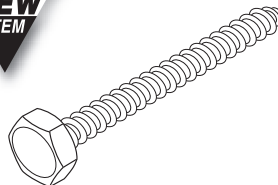

**220-322** 1" x 1 1/2"

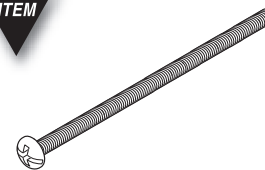

**220-425** 1/4"-20 3"

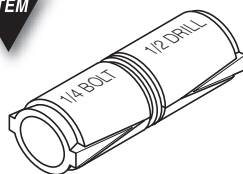

**220-500** 1/4"

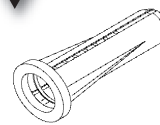

**220-515** 6-8 x 1"  
**220-520** 1/4" x 2 1/2"  
**220-525** 1/4" x 3"  
**220-510** 10-12 x 1"