

ELBOWS *continued*

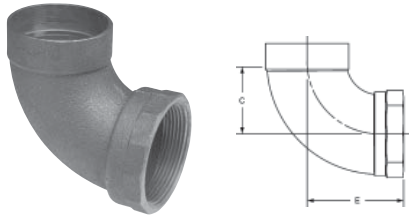

807-3
DWV 90° Elbow
C x F – Cast

NOM. SIZE	APPROX. NET WT./LBS.	DIM. C INCHES	DIM. E INCHES
1 1/2	0.72	1 ¹³ / ₃₂	2 ¹ / ₈
2	1.15	1 ⁷ / ₈	2 ¹¹ / ₁₆

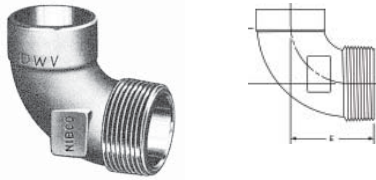

807-4
DWV 90° Elbow
C x M – Cast

NOM. SIZE	APPROX. NET WT./LBS.	DIM. C INCHES	DIM. E INCHES
1 1/2	0.66	1 ¹³ / ₃₂	2 ³ / ₃₂

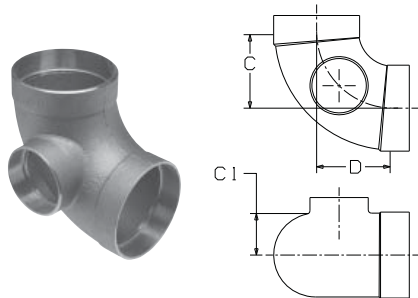

807-9
DWV 90° Elbow w/Side Inlet
C x C x C – Cast

NOM. SIZE	APPROX. NET WT. LBS.	DIMENSIONS INCHES		
		C	C ₁	D
3 x 3 x 2	2.55	2 ⁷ / ₈	1 ⁵ / ₈	2 ⁷ / ₈

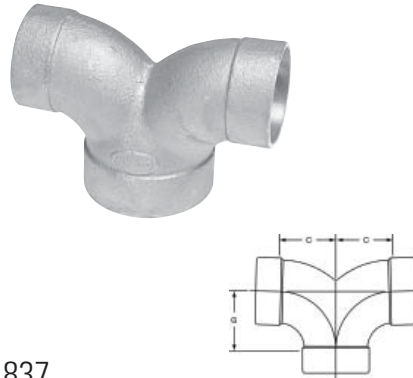

837
DWV 90° Double Elbow
C x C x C – Cast

NOM. SIZE	APPROX. NET WT./LBS.	DIM. C INCHES	DIM. G INCHES
1 1/2	0.77	1 ¹³ / ₃₂	1 ¹³ / ₃₂
2	1.31	1 ⁷ / ₈	1 ⁷ / ₈
2 x 1 1/2 x 1 1/2	0.97	1 ⁵ / ₈	1 ¹ / ₂

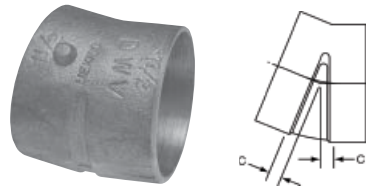

808
DWV 22¹/₂° Elbow
C x C – Cast

NOM. SIZE	APPROX. NET WT./LBS.	DIM. C INCHES
1 1/4	0.22	3 ³ / ₁₆
1 1/2	0.28	1 ¹ / ₄
2	0.48	1 ¹¹ / ₃₂
3	0.99	1 ⁷ / ₃₂

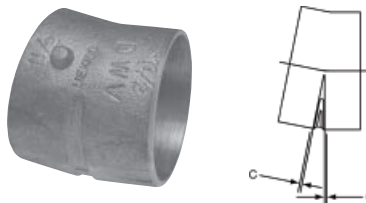

809
DWV 11¹/₄° Elbow
C x C – Cast

NOM. SIZE	APPROX. NET WT./LBS.	DIM. C INCHES
1 1/2	0.22	5 ⁵ / ₃₂
2	0.38	3 ³ / ₁₆

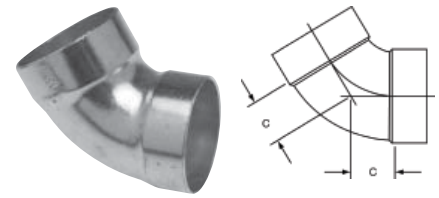

960
DWV 60° Elbow
C x C – Wrot

NOM. SIZE	APPROX. NET WT./LBS.	DIM. C INCHES
1 1/2	0.24	1 ³ / ₁₆
2	0.44	1 ¹ / ₈
3	0.95	1 ⁷ / ₈

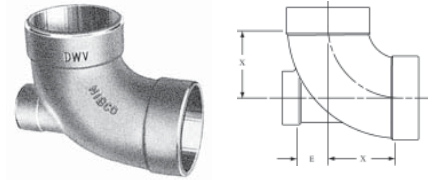

861-LH
DWV 90° Elbow
w/Low Heel Inlet
C x C x C – Cast

NOM. SIZE	APPROX. NET WT./LBS.	DIM. C INCHES	DIM. E INCHES
3 x 3 x 2	2.43	2 ⁷ / ₈	1 ⁹ / ₃₂

PLUGS

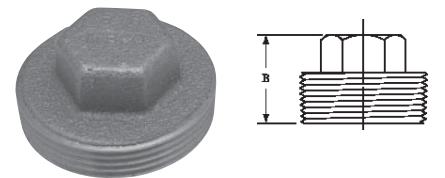

818 A.S.A.
DWV Plug
M – Cast

NOM. SIZE	APPROX. NET WT./LBS.	DIM. B INCHES
3/4	0.08	2 ³ / ₃₂
1	0.12	2 ⁹ / ₃₂
1 1/4	0.19	3 ¹ / ₃₂
1 1/2	0.21	1 ³ / ₃₂
2	0.34	1 ⁵ / ₁₆

Consult price sheet for Made to Order items and for minimum order quantities.