

1. Bottom Connection
2. Back Connection

Description & Features:

- Highly accurate reading of low pressures
- Brass or stainless steel wetted parts
- Ranges from 15" H₂O vacuum to +10 psi
- CRN registered
- 5 year warranty

Applications:

- Suitable for measuring gaseous media both corrosive and non-corrosive
- Used to measure natural gas pressure as well air flow indications and leak detection
- Vacuum pumps, air compressors, air filters, gas burners, vacuum ovens, suction regulators and respirators

Specifications	Stainless Steel Internals	Brass Internals
Dial	2.5" (63mm), 4" (100mm), 4.5" (115mm) and 6" (150mm), white aluminum dial with black and red markings	2.5" (63mm), 4" (100mm), 4.5" (115mm) and 6" (150mm), white aluminum dial with black and red markings
Case	2.5" (63mm), 4" (100mm): AISI 304 SS 4.5" (115mm), 6" (150mm): Aluminum, painted black	2.5" (63mm), 4" (100mm): Steel, painted black 4.5" (115mm), 6" (150mm): Cast aluminum, painted black
Lens	2.5" (63mm): Polycarbonate 4" (100mm), 4.5" (115mm), 6" (150mm): Glass	2.5" (63mm): Polycarbonate 4" (100mm), 4.5" (115mm), 6" (150mm): Glass
Ring	2.5" (63mm), 4" (100mm): Steel 4.5" (115mm), 6" (150mm): Aluminum	2.5" (63mm), 4" (100mm): Steel 4.5" (115mm), 6" (150mm): Aluminum
Socket	AISI 316 SS	Brass
Connection	1/4" NPT standard	1/4" NPT standard
Diaphragm Element	AISI 316 SS	Phosphor bronze
Movement	AISI 316 SS	2.5" (63mm): Engineering plastic upper and lower plate with brass pinion and sector; 4" (100mm), 4.5" (115mm), 6" (150mm): Brass
Pointer	Aluminum, anodized black	Aluminum, anodized black
Welding	TIG	Solder/brazed
Working Pressure	75% of full scale value	60% of full scale value (fluctuating) 75% of full scale value (static)
Over-Pressure Limit	30% of full scale value	30% of full scale value
Ambient/Process Temperature	-40°F to 150°F (-40°C to 65°C)	-40°F to 150°F (-40°C to 65°C)
Accuracy	2.5": ±3-2-3% ANSI/ASME Grade B 4" (100mm), 4.5" (115mm), 6" (150mm): ±1% ANSI/ASME Grade 1A	2.5": ±3-2-3% ANSI/ASME Grade B 4" (100mm), 4.5" (115mm), 6" (150mm): ±1% ANSI/ASME Grade 1A
Enclosure Rating	IP52	IP52

Order Codes (products in bold are normally in stock)

Dial Size	2.5" (63mm)			4" (100mm)				4.5" (115mm)			
Case Material	Steel		SS	Steel	SS	Steel		Aluminum		Aluminum	
Connection	1/4" Bottom	1/4" Centre Back	1/4" Bottom	1/4" Bottom		1/4" Centre Back		1/4" Bottom		1/4" Centre Back	
Movement, Socket, Capsule	Brass	Brass	SS	Brass	SS	Brass	SS	Brass	SS	Brass	SS
0-15" water vac	PLP300V	PLP340V	PLP350V	PLP310V	PLP4200V	PLP4230V	PLP4240V	PLP4250V	PLP4260V	PLP4290V	PLP4300V
0-32" water vac.	PLP301V	PLP341V	PLP351V	PLP311V	PLP4201V	PLP4231V	PLP4241V	PLP4251V	PLP4261V	PLP4291V	v4301V
0-55" water vac.	PLP302V	PLP342V	PLP352V	PLP312V	PLP4202V	PLP4232V	PLP4242V	PLP4252V	PLP4262V	PLP4292V	PLP4302V
0-100" water vac.	PLP304V	PLP343V	PLP353V	PLP313V	PLP4203V	PLP4233V	PLP4243V	PLP4253V	PLP4263V	PLP4293V	PLP4303V
0-200" water vac.	PLP303V	-	-	-	-	-	-	-	-	-	-
0-15" water/oz	PLP300	PLP340	PLP350	PLP310	PLP4200	PLP4230	PLP4240	PLP4250	PLP4260	PLP4290	PLP4300
0-32" water/oz	PLP301	PLP341	PLP351	PLP311	PLP4201	PLP4231	PLP4241	PLP4251	PLP4261	PLP4291	PLP4301
0-55" water/oz	PLP302	PLP342	PLP352	PLP312	PLP4202	PLP4232	PLP4242	PLP4252	PLP4262	PLP4292	PLP4302
0-100" water/oz	PLP304	PLP343	PLP353	PLP313	PLP4203	PLP4233	PLP4243	PLP4253	PLP4263	PLP4293	PLP4303
0-200" water/oz	PLP303	PLP346	PLP356	PLP316	PLP4206	PLP4236	PLP4246	PLP4256	PLP4266	PLP4296	PLP4306
0-5 psi/kPa	PLP305	PLP344	PLP354	PLP314	PLP4204	PLP4234	PLP4244	PLP4254	PLP4264	PLP4294	PLP4304
0-10 psi/kPa	PLP306	PLP345	PLP355	PLP315	PLP4205	PLP4235	PLP4245	PLP4255	PLP4265	PLP4295	PLP4305

Dial Size	6" (150mm)			
Case Material	Aluminum		Aluminum	
Connection	Bottom 1/4"		Centre Back 1/4"	
Movement, Socket, Capsule	Brass	SS	Brass	SS
0-15" water vac	PLP4310V	PLP4320V	-	-
0-32" water vac.	PLP4311V	PLP4321V	-	-
0-55" water vac.	PLP4312V	PLP4322V	-	-
0-100" water vac.	PLP4313V	PLP4323V	-	-
0-200" water vac.	-	-	-	-
0-15" water/oz	PLP4310	PLP4320	-	PLP4360
0-32" water/oz	PLP4311	PLP4321	PLP4351	PLP4361
0-55" water/oz	PLP4312	PLP4322	-	-
0-100" water/oz	PLP4313	PLP4323	PLP4353	PLP4363
0-200" water/oz	PLP4316	PLP4326	-	-
0-5 psi/kPa	PLP4314	PLP4324	PLP4354	PLP4364
0-10 psi/kPa	PLP4315	PLP4325	PLP4355	PLP4365

Note: Other ranges and connection sizes available upon request

Option suffix for above order codes only:

- UC = 2.5"(63mm) U-Clamp
- LPFF = 4.5"(115mm) Front flange
- LPFF6 = 6" (150mm) Front flange
- LPBF = Back flange (all sizes except 2.5")
- 45Phenolic = Phenolic case on 4.5" SS

2.5" Back Connection with U-Clamp Brass

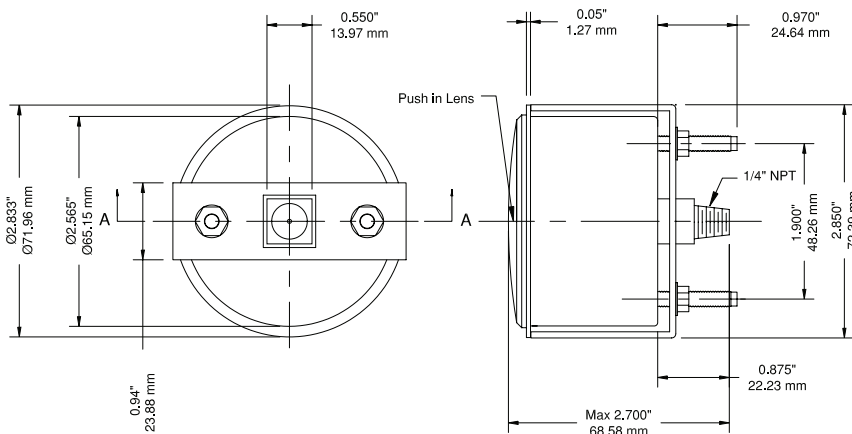

2.5" Bottom Connection Brass

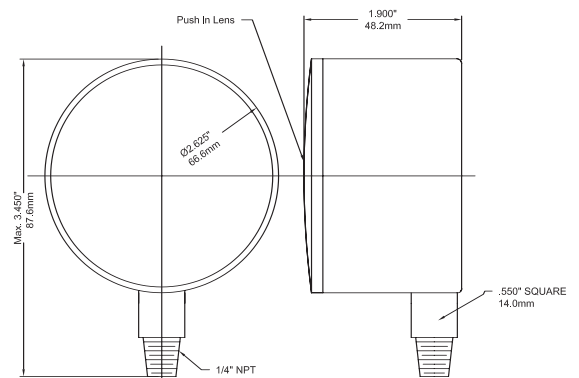

4" Bottom Connection Brass

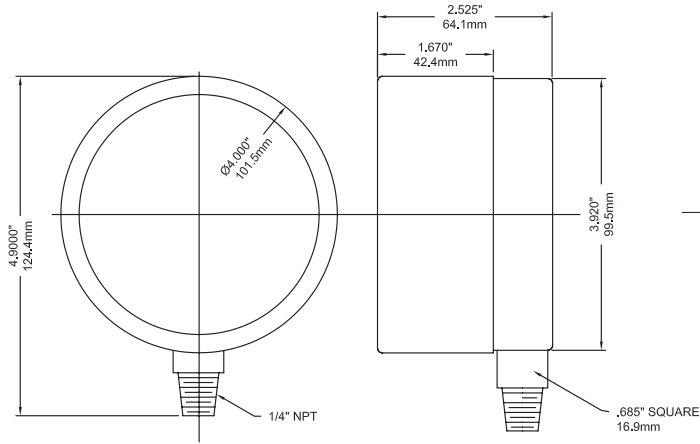

4" Back Connection Brass

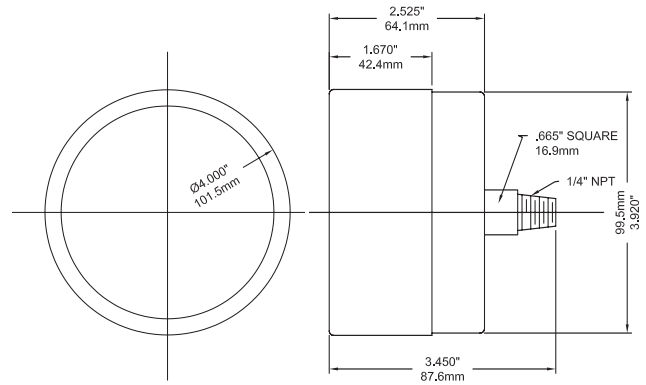

4.5" Bottom Connection Stainless Steel

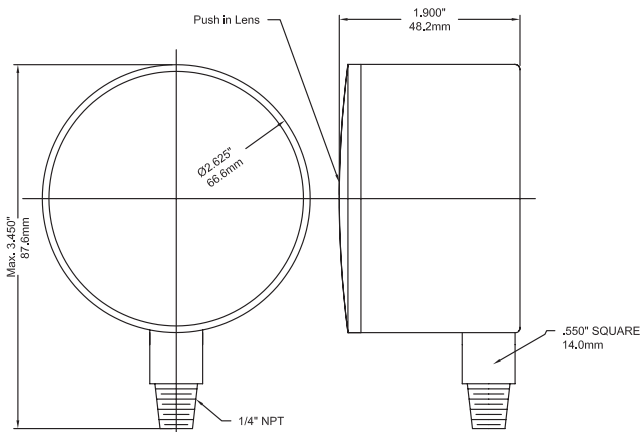

4.5" Back Connection Stainless Steel

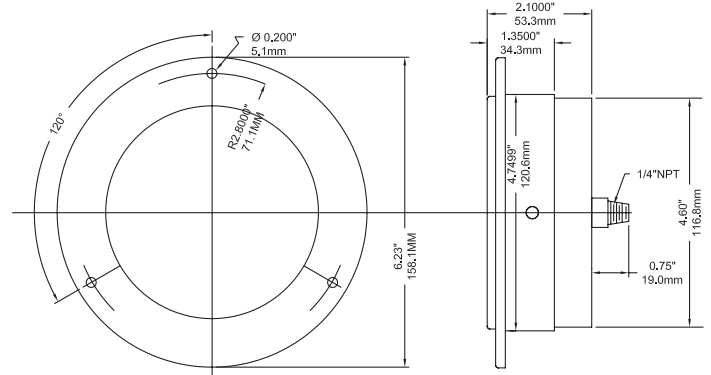

6" Bottom Connection Stainless Steel

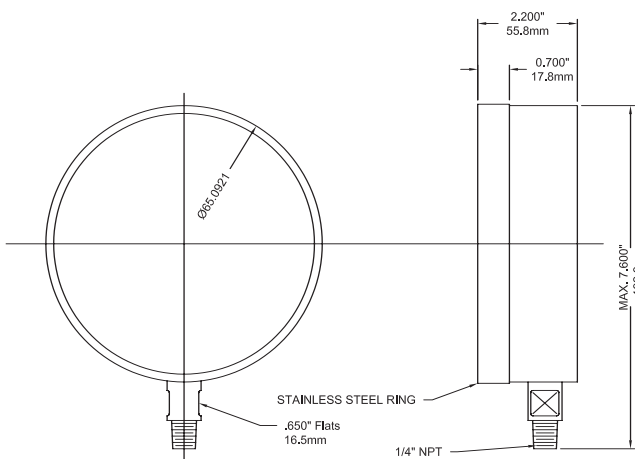

6" Back Connection Stainless Steel

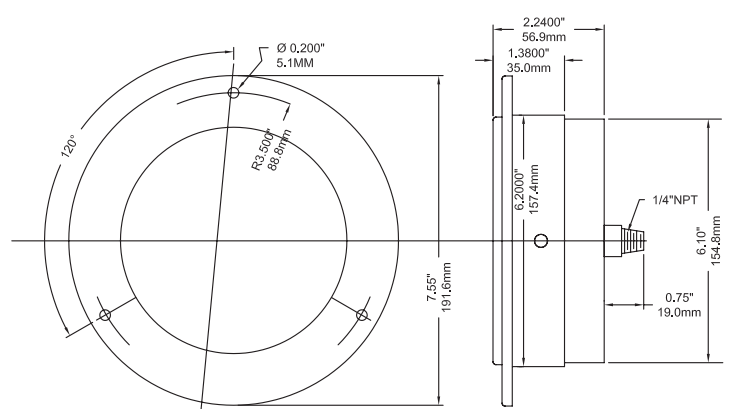

Series Number (for custom, non-standard product)

	P	L	P												
SERIES															
DIAL SIZE															
2.5" (63mm)				2	5										
4.0" (100mm)				4	0										
4.5" (115mm)				4	5										
6.0" (150mm)				6	0										
CASE MATERIALS															
304SS															
Aluminum															
Steel Painted Black															
WETTED PARTS															
Brass															
316SS															
CONFIGURATION															
Bottom Connection, Stem Mounting															
Bottom Connection, Back Flange, Surface Mounting															
Bottom Connection, Front Flange, Surface Mounting															
Back Connection, Stem Mounting															
Back Connection, Back Flange, Surface Mounting															
Back Connection, Wide Front Flange, (Drilled) Panel Mounting															
Back Connection, Narrow Front Ring, Panel Mounting (Yoke)															
CONNECTION SIZE															
1/8"															
1/4"															
3/8"															
1/2"															
Special															
THREAD															
NPT															
BSP (G)															
BSPT (R)															
Special															
PRIMARY SCALE															
UNITS - See Page 10															
RANGE - See Page 10															
SECONDARY SCALE															
UNITS - See Page 10															
OPTIONS															
Oxygen Cleaning															S L
Phenolic Case															S S
Stainless Steel Tag Plate															S M
Test Certificate															S O
No Options															X X