

# SSV Series

Vertical Multistage Pumps



**New!!**  
**Expanded Range**  
**Capable of Flows up to**  
**650 GPM!!**

[www.goulds.com](http://www.goulds.com)

Goulds Pumps



ITT Industries

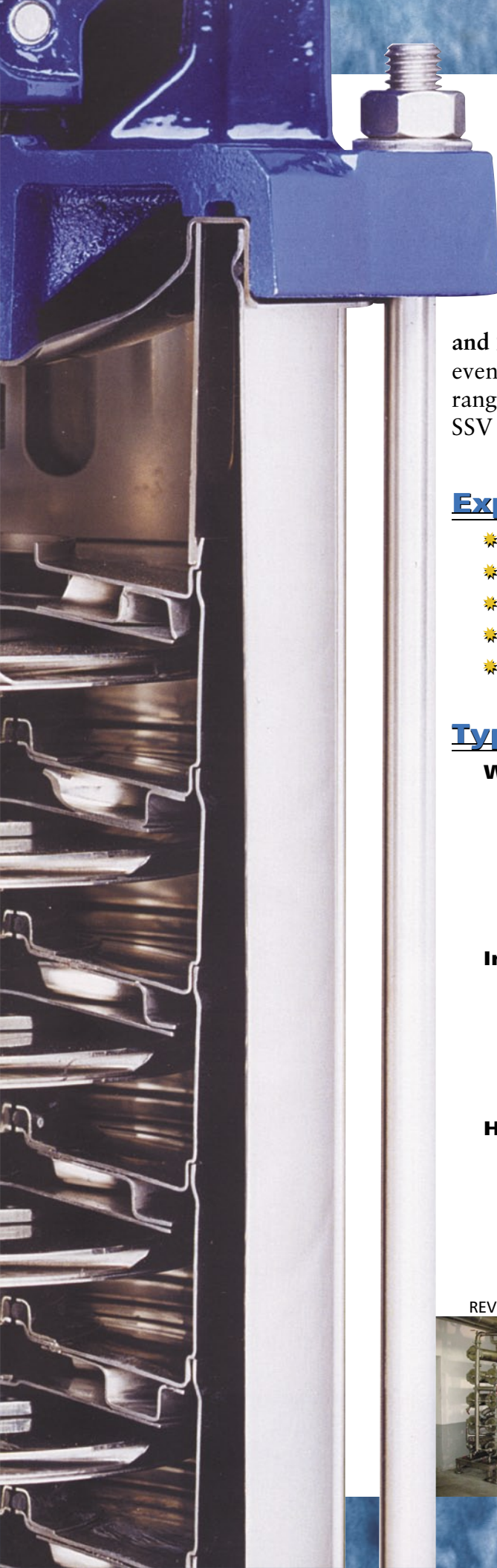

## ***SSV...a tradition of Superior Multi-Stage Pump Design***

Building on years of experience gained in thousands of successful SSV installations around the world, our engineers have added four new sizes (33SV, 46SV, 66SV and 92SV) to the SSV pump range making it adaptable to an even wider range of services. The comprehensive hydraulic range combined with innovative value adding features make SSV "The Answer" for all your high pressure pumping needs.

### **Expanded Capabilities**

- ✦ Flows up to 650 GPM (147 m<sup>3</sup>/h).
- ✦ Heads up to 1200 Ft (365 m).
- ✦ Pressures up to 580 PSI (40 Bar).
- ✦ Temperatures up to 250° F (121° C).
- ✦ 8 Pumps Sizes up to 75 HP (60 kw).

### **Typical Applications**

#### **Water Supply**

- ✦ Transfer and distribution from water systems.
- ✦ Pressure boosting in apartment buildings and hotels.
- ✦ Packaged booster sets.

#### **Water Treatment**

- ✦ Filtration
- ✦ Reverse osmosis systems
- ✦ Ultrafiltration

#### **Industrial/OEM**

- ✦ Parts washing
- ✦ Car wash
- ✦ Paint systems
- ✦ Process/Plant Water

#### **Agriculture**

- ✦ Irrigation systems
- ✦ Greenhouses
- ✦ Humidifiers

#### **Heating, Ventilating and Air Conditioning (HVAC)**

- ✦ Boiler feed
- ✦ Heat exchangers
- ✦ Cooling towers and systems
- ✦ Chillers

REVERSE OSMOSIS



PRESSURE BOOSTING



CAR WASH

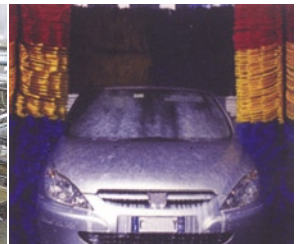

## Time Tested, Value Adding SSV Product Features

The new sizes of the SSV blends many of the proven features of the existing SSV with *new design innovations* to provide a pumping solution with optimized performance, “real-life” functionality and the high standard of quality you’ve grown accustomed to expect from the SSV. No matter whether you need

to boost pressure for a small chiller system or if you need to make large volumes of fresh water at a resort the SSV range is completely capable of meeting your high pressure pumping requirements.



## Hydraulic Thrust Balanced Design

All SSV pumps are designed to hydraulically counter-balance the thrust loads generated during the pumping action. The lower thrust loads both **increases pump life** and allow the complete range of SSV pumps to be operated with any standard NEMA C-Face motor.

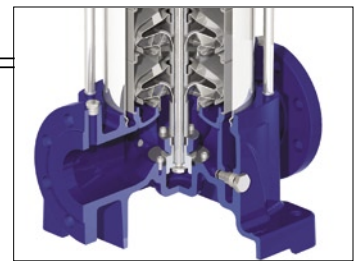

## Engineered Shaft Sealing Solutions

The most common reason for pump downtime is due to failure of the mechanical seal. Typically seal failures are the result of an unfavorable seal environment such as dry running often caused by the presence of vapor which has not been vented from the piping system. The seal chamber of the SSV pump has been engineered to locate the seal faces at the lowest point of the seal chamber away from areas where vapors tend to collect to reduce the potential for dry running and pre-mature failure of the seals.

## Superior Hydraulic Performance

Because energy costs represent the largest expense over the life of a pump, our engineers have coupled over 155 year of pump hydraulic design with the latest fluid flow analytical tools to optimize the performance of the SSV pump to unrivaled levels. Each SSV contains close tolerance seal rings to eliminate losses between each pumping stage and with eight (8) hydraulic sizes to choose from, system designers are capable of selecting a pump nearest it's ideal operating point (BEP).



## Cost Effective, Maintainable Design

You can comfortably expect a long service life from the SSV pump, yet the SSV has been designed to simplify and reduce the cost of maintaining your investment. The SSV utilizes "off-the-shelf" **standard NEMA motors** and sealing components which are commercially available so you don't need to fill your store rooms with costly special motors and mechanical seals. Furthermore, the new large flow sizes have been engineered to allow easy **replacement of the mechanical seal without removal of the motor**.

## A Broad Array of Configurations to Simplify Installation and Piping

Highly flexible, the SSV pump series allows you to choose the most suitable solution for your specific installation requirements from a wide range of configurations.

### The 1SV, 2SV, 3SV and 4SV models are available in the following versions:

- ✦ **SVA**, made of AISI 304 stainless steel, in-line, oval connections with NPT threads.
- ✦ **SVB**, made of AISI 304 stainless steel, in-line ANSI flanges.
- ✦ **SVC**, made of AISI 304 stainless steel, ANSI flanges with the discharge above the suction.
- ✦ **SVD**, made of AISI 316 stainless steel, in-line ANSI flanges.
- ✦ Victaulic Connections can be provided on the 1SV-4SV size in either 304 or 316 stainless steel.

### For models 33SV, 46SV, 66SV and 92SV, two solutions are available:

- ✦ **SVB**, 316L stainless steel liquid end and cast iron castings, in-line ANSI flanges.
- ✦ **SVD**, liquid end and castings made entirely of AISI 316 stainless steel, in-line ANSI flanges.

A wide range of **special configurations** are also available (e.g. alternative materials for elastomers and mechanical seal, special voltages for motors, horizontal installation, etc.), including versions designed for applications with high temperature and high pressure conditions.

### VERSIONS AVAILABLE

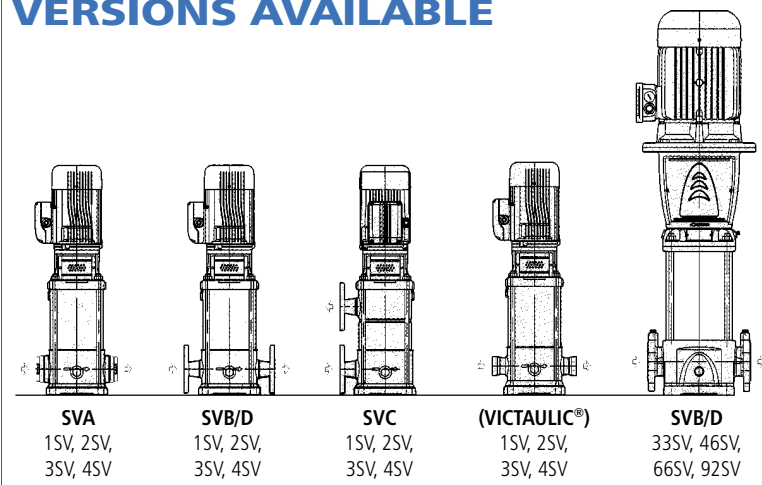

BOOSTER PUMP PACKAGES



IRRIGATION SYSTEMS



BOILER FEED



# SSV Design Innovations...Engineered to Deliver Results

## High Efficiency Hydraulic Design

The latest computer aided fluid dynamic design techniques were utilized to optimize hydraulic performance. Durable, chemical resistant polymer neck rings are used to seal between stages to minimize hydraulic losses resulting **in benchmarked pump efficiency.**

- Impellers and diffusers are constructed of corrosion resistant 316L stainless steels.
- State-of-the-Art laser welding technology and manufacturing processes provide high quality welds which minimize distortion and improve chemical resistance in the weld area.

## Heavy Duty Cast Pump Bodies

Rugged cast iron or cast 316 stainless steel pump bodies with ANSI dimensioned flanges and integral mounting feet allow the SSV to be easily installed in any piping systems and are **easily capable of retrofit in place of previous SSV models!** Precision castings streamline the inlet flow into the suction for superior NPSHr performance.

## Hydraulic Thrust Balanced Design

An internal "Thrust Piston" is used to reduce the hydraulic thrust loads generated in the pump to support the use of **standard Off-the-Shelf NEMA C-face motors.** The thrust piston circulates a small portion of the high pressure discharge liquid beneath the piston assembly to counter-act and reduce the hydraulic thrust loads so that **special motors with oversized bearings are not required.**



## Maintenance Friendly Design

Large access openings and generous shaft separation allow for **replacement of the mechanical seal without removal of the motor.** Faster and safer seal replacement means your pump will be back on-line sooner!

## Engineered Shaft Sealing Solutions

Like the smaller sizes in the range, the seal chamber design locates the seal faces at a low point in the seal cavity to insure that they are far away from vapors, is prone to collect at the high point of systems, to prevent against dry running and premature seal failures.

As standard, an "off-the shelf" pressure **balanced mechanical seal** capable of sealing up to **580 psi** is provided. Seal faces are constructed of wear resistant Silicon Carbide and Carbon and Viton® elastomers provide universal resistance to many chemicals. Optional face materials and elastomers as well as a **cartridge seal configuration** can be provided on request.



## Upgrade SSV with Aquavar® for Complete Process Control

The entire range of SSV pumps can be supplied with the industry leading Aquavar Variable Speed Pump controller to provide a complete process solution capable of delivering significant, quantifiable savings! Aquavar, the worlds first microprocessor driven variable speed control specifically developed for pump control, is available in a space saving motor mounted design which can be mounted to any standard three phase TEFC motor up to 30 HP or in a wall mounted version up to 550 HP.

### What Can Aquavar Do?

#### Reduces Electricity Cost by Up to 50%

SSV pumps fitted with Aquavar controllers have been proven in thousand of "real world" installations to reduce energy cost by up to 50%. This is accomplished as the Aquavar continuously monitors system demand and then regulates the pump performance (speed) to match system requirements. Wasted pumping energy normally expended across control (PRV) valves and in bypass lines is eliminated.

#### Example of Energy Savings on 15 HP Pump

% Capacity	Constant Speed KW	AQUAVAR Controller KW (System Curve)	Savings X	½ Year (2,920 hours)
25%	5.8 KW	1.8 KW	4.0 KW	11,680 KWH
50%	7.6 KW	3.2 KW	4.4 KW	12,848 KWH
75%	9.2 KW	5.7 KW	3.5 KW	10,220 KWH
				<b>→ 34,748 KWH*</b>

\* Savings based on comparison of constant speed pump system versus variable speed controller. Savings are not guaranteed and will vary based on operation, usage and local energy rates. This is only a comparative example.

**First Year Energy Savings (constant running)**

The additional investment in an AQUAVAR controller over a standard pump could be returned in energy savings by the first year!

#### Reduces Maintenance Cost and Pump Downtime

Through continuous monitoring of the pumping system, the Aquavar control logic is capable of detecting system conditions which normally will result in pump failure. Costly situations such as dry running, dead heading and cavitation that normally cause a standard pump to fail can be avoided as the Aquavar control will either shutdown or slow down the pump until corrective actions can be applied.

#### Unparalleled Process Control and System Communication Interface

SSV pump fitted with Aquavar can be programmed to turn on and off with a ramping up\down function to provide smoother operation and eliminate "water hammer". In addition, the Aquavar control is capable of communicating with many process management systems for remote control and complete system integration.

### Why Aquavar?

#### Hassle Free Start-Up

The Aquavar programming menu include system terminology to enable most any "pump person" to start-up the Aquavar in a few minutes.

#### No Special Motors

All Aquavar units can be mounted to **any standard three-phase TEFC motor** making the Aquavar adaptable to a variety of service conditions or plant standards and will simplify any future motor repairs or replacements.

#### Reduced System Installation Cost and Foot-Print

By eliminating the need for starter panels, control valves, bypass lines and large pressure storage tanks, Aquavar fitted SSV pumps actually reduce the total installation cost of a pumping system. Aquavar fitted SSV pumps also require less "real estate" making them easier to install in tight spaces and easier for maintenance personnel to more efficiently perform normal maintenance tasks.



# SSV Hydraulic Coverage and Technical Data

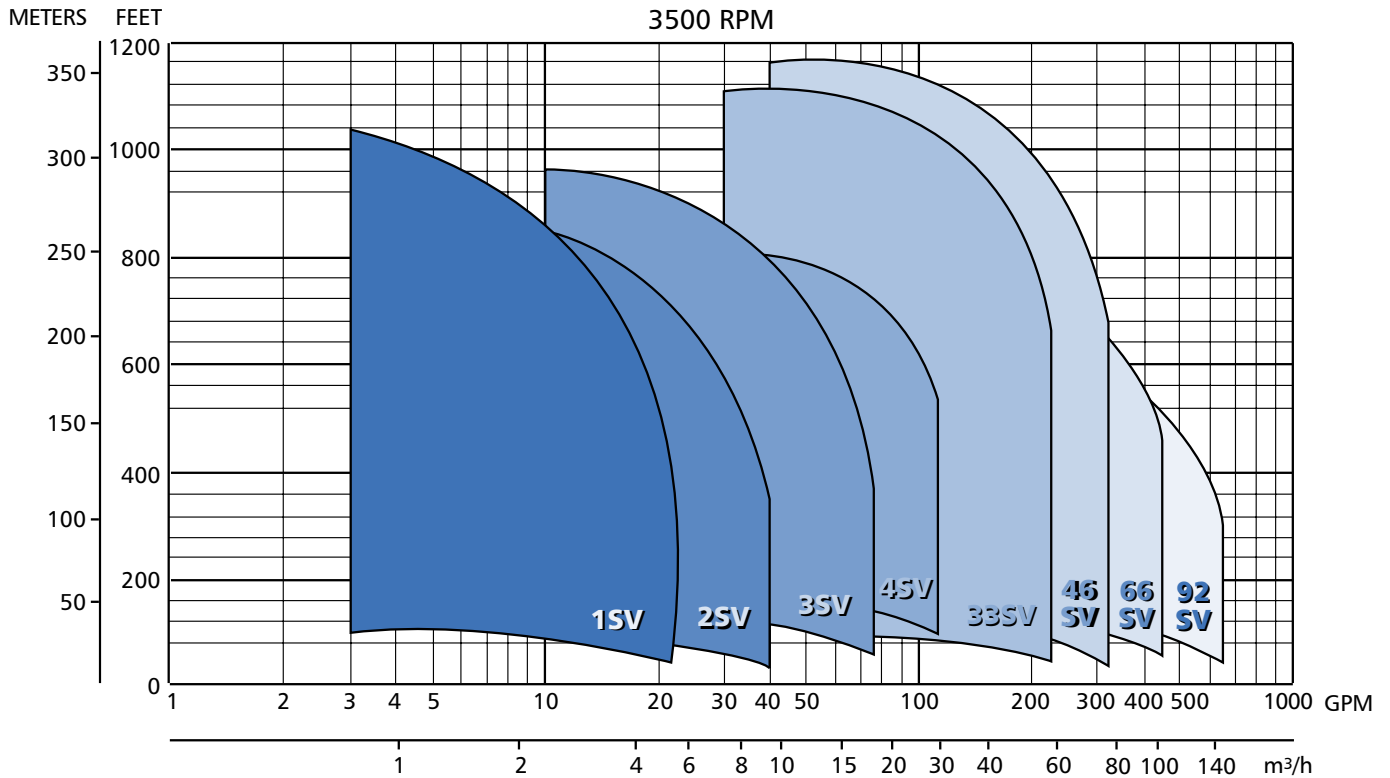

SSV Product Range	1SV	2SV	3SV	4SV	33SV	46SV	66SV	92SV
Nominal Flow (GPM)	15	30	60	85	170	225	375	500
Flow Range	2 - 22	6 - 40	11 - 75	17 - 110	34 - 225	45 - 320	75 - 450	100 - 650
Max. Head (Ft)	1100	945	1005	930	1125	1210	850	715
Max. Working Pressure (PSI)	360 PSIG <sup>1</sup>				360/580 PSIG			
Temperature Range	-20° F to 250° F (-30° C to 121° C)							
Motor Power (HP)	½ - 5 HP	¾ - 7½ HP	2 - 15 HP	5 - 25 HP	3 - 60 HP	7½ - 75 HP	10 - 75 HP	15 - 75 HP
<b>Material of Construction</b>								
SVA	AISI 304SS				-	-	-	-
SVB	AISI 304SS				Cast Iron \ AISI 316LSS			
SVC	AISI 304SS				-	-	-	-
SVD	AISI 316LSS				316SS \ AISI 316LSS			
<b>Connection Sizes</b>								
SVA - Oval NPT	1" NPT (Female)	1¼" NPT (Female)	1½" NPT (Female)		-	-	-	-
SVB - Round ANSI Size\Class	1¼" 300 #	1¼" 300 #	2" 300 #	2" 300 #	2½" 125/250 #	3" 125/250 #	4" 125/250 #	4" 125/250 #
SVC - Top\Bottom Round ANSI - Size\Class	1¼" 300 #	1¼" 300 #	2" 300 #	2" 300 #	-	-	-	-
SVD - Round ANSI Size\Class	1¼" 300 #	1¼" 300 #	2" 300 #	2" 300 #	2½" 150/300 #	3" 150/300 #	4" 150/300 #	4" 150/300 #
<b>Optional Connections (on request)</b>								
Victaulic (PJE)	1¼" (Victaulic)	1¼" (Victaulic)	2" (Victaulic)	2" (Victaulic)	-	-	-	-

<sup>1</sup>Some staging may have MAWP of 580 PSI (40 bar).

## ***High Pressure Pumping Solutions Beyond the Norm...***

**F**or services outside the envelop of the SSV, G&L Pumps offers complementary multi-stage pump solutions to achieve either lower flows or higher pressures and flows. The GB pump range is a compact economical design capable of low flows and high pressure and is ideally suited for Reverse Osmosis or OEM applications.

The SMVT and MPVN multistage pumps offer extended flow and pressure capabilities with flows up to 1500 GPM and pressures up to 800 psi (55 bar). Offered in both cast iron and all 316SS stainless steel, these pumps are ideally suited for many demanding service requirements.

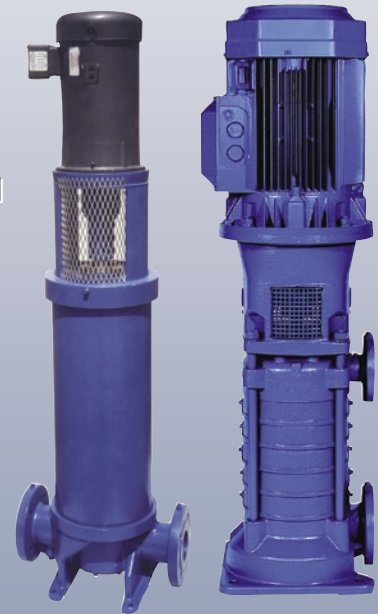

### **Complete Pressure Boosting Packaged Solutions**

Also available from G&L Pumps is a full line of Pre-packaged Booster Pumps which integrate the SSV pump and the Aquavar controller into a complete engineered package. Featuring stainless steel piping, the AquaForce™ packaged system are completely pre-wired for simple installation and are available in either duplex or triplex configurations.

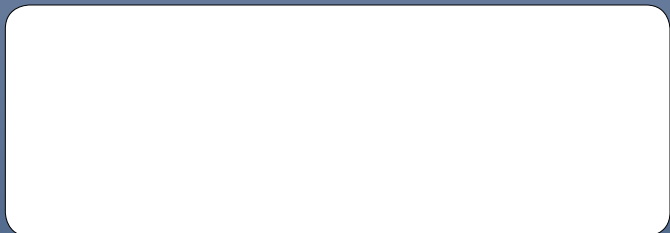

Goulds Pumps is a brand of ITT Water Technology, Inc.  
- a subsidiary of ITT Industries, Inc.

Goulds Pumps, G&L Pumps, Aquavar, AquaForce and the ITT Engineered Blocks Symbol are registered trademarks and tradenames of ITT Industries.

Viton is a registered trademark of DuPont.

© 2004 ITT Water Technology, Inc.  
August, 2004  
Printed In U.S.A.  
BSSVSR

Specifications subject to change without notice.

Goulds Pumps

