





Model XF228-B1 shown with Component AV Foundations™ model CFV69-EB1 and Euro Speaker Foundations™ model EF28b

VISIONMOUNT® LARGE MOUNTS



« ProSet™ height and level adjustments ensure TV is perfectly positioned, even after installation



« ClickStand™ feature holds TV away from wall for easy cable installation, then clicks securely back onto wall plate



« FollowThru™ in-arm cable management channel protects and conceals cables—even through the elbow—for a truly flawless look



« ClickFit™ system allows power conditioners and other small devices to be positioned directly behind TV and easily clicked onto mount, so they stay hidden yet easily accessible



« Super Slim low-profile mount places TVs just .55" from wall — less than the width of a die







« Universal mounting brackets fit virtually any LCD, LED and plasma TV from 30" to 60"









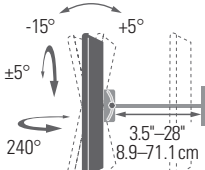

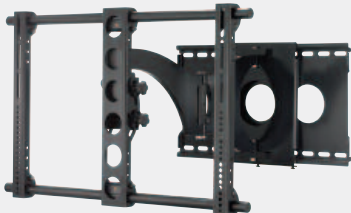

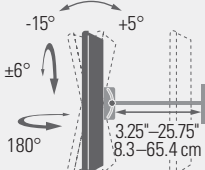

« All models offer lateral shift to allow perfect TV placement even with off-center studs



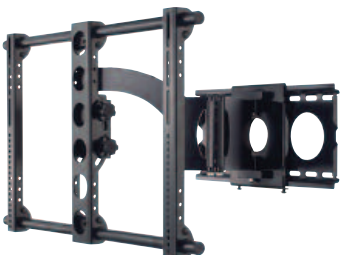



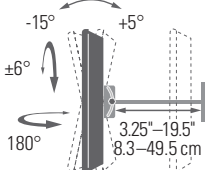



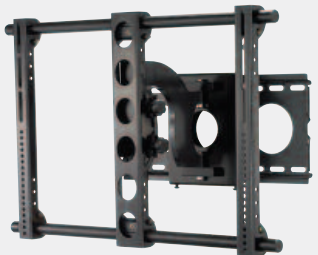

« Full-motion and tilting mounts feature the Virtual Axis™ mechanism for balanced tilting with the touch of a fingertip

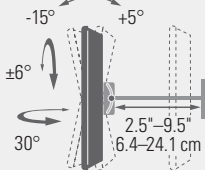

MODEL LF228-B1  NEW	DESCRIPTION Full-motion Wall Mount for large flat-panel TVs with 28" extension Allows ±5° lateral roll to ensure TV is perfectly level after hanging			 CORNER MOUNTING		
	PRODUCT DIMENSIONS (w x d x h) 31" x 3.5"–28" x 23.75" 78.7 x 8.9–71.1 x 60.3 cm	WEIGHT CAPACITY 130 lbs. 59 kg	TV SIZE 37" – 58"			
	MOUNTING PATTERN UNIVERSAL					



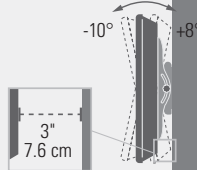

MODELS VMAA26b-01 VMAA26s-01 	DESCRIPTION Full-motion Wall Mount for large flat-panel TVs with 26" extension Allows ±6° lateral roll to ensure TV is perfectly level after hanging			 CORNER MOUNTING		
	PRODUCT DIMENSIONS (w x d x h) 29.5" x 3.25"–25.75" x 18.5" 74.9 x 8.3–65.4 x 47 cm	WEIGHT CAPACITY 130 lbs. 59 kg	TV SIZE 30" – 56"			
	MOUNTING PATTERN UNIVERSAL	FEATURE Use with VMCC1s & LAS1A (pg. 88) to attach center-channel & side speakers				

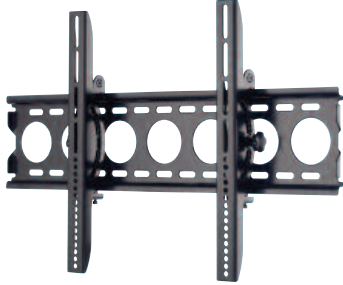

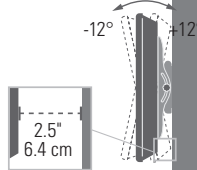

MODELS VMAA18b-01 VMAA18s-01 	DESCRIPTION Full-motion Wall Mount for large flat-panel TVs with 19.5" extension Allows ±6° lateral roll to ensure TV is perfectly level after hanging			 CORNER MOUNTING		
	PRODUCT DIMENSIONS (w x d x h) 29.5" x 3.25"–19.5" x 18.5" 74.9 x 8.3–49.5 x 45.7cm	WEIGHT CAPACITY 130 lbs. 59 kg	TV SIZE 30" – 56"			
	MOUNTING PATTERN UNIVERSAL	FEATURE Use with VMCC1s & LAS1A (pg. 88) to attach center-channel & side speakers				



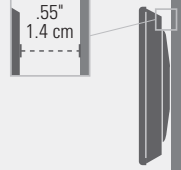

MODELS VMSAb VMSAs 	DESCRIPTION Full-motion Wall Mount for large flat-panel TVs with 9.5" extension Allows ±6° lateral roll to ensure TV is perfectly level after hanging			 CORNER MOUNTING		
	PRODUCT DIMENSIONS (w x d x h) 29.5" x 2.5"–9.5" x 18.5" 74.9 x 6.4–24.1 x 47 cm	WEIGHT CAPACITY 150 lbs. 68 kg	TV SIZE 30" – 56"			
	MOUNTING PATTERN UNIVERSAL	FEATURE Use with VMCC1s & LAS1A (pg. 88) to attach center-channel & side speakers				

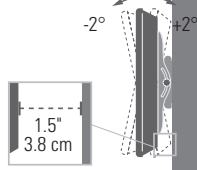
MODELS LT25-B1 LT25-S1		DESCRIPTION Tilting Wall Mount for large flat-panel TVs			 
		PRODUCT DIMENSIONS (w x d x h) 30" x 3" x 18.25" 76.2 x 7.6 x 46.4 cm	WEIGHT CAPACITY 175 lbs. 79.4 kg	TV SIZE 30" – 60"	
		MOUNTING PATTERN UNIVERSAL	FEATURE Use with VMA201 (pg. 88) soundbar speaker		

MODELS VMPL50b VMPL50s		DESCRIPTION Tilting Wall Mount for large flat-panel TVs			 
		PRODUCT DIMENSIONS (w x d x h) 29" x 2.5" x 18.5" 73.7 x 6.4 x 47 cm	WEIGHT CAPACITY 130 lbs. 59 kg	TV SIZE 30" – 56"	
		MOUNTING PATTERN UNIVERSAL			

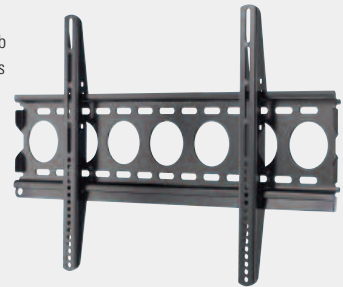
MODELS LL11-B1 LL11-S1 		DESCRIPTION Super Slim Low-Profile Mount for large flat-panel TVs			 
		PRODUCT DIMENSIONS (w x d x h) 35.3" x .55" x 22.5" 89.7 x 1.4 x 57.2 cm	WEIGHT CAPACITY 150 lbs. 68 kg	TV SIZE 37" – 65"	
		MOUNTING PATTERN UNIVERSAL			

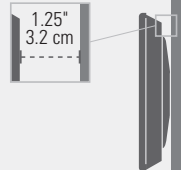
MODELS LL22-B1 LL22-S1		DESCRIPTION Low-profile Wall Mount for large flat-panel TVs			 
		PRODUCT DIMENSIONS (w x d x h) 30" x 1.5" x 18.25" 76.2 x 3.8 x 46.4 cm	WEIGHT CAPACITY 175 lbs. 79.4 kg	TV SIZE 30" – 60"	
		MOUNTING PATTERN UNIVERSAL	FEATURE Use with VMA201 (pg. 88) soundbar speaker		

MODELS VMPL250b VMPL250s		DESCRIPTION Low-profile Wall Mount for large flat-panel TVs			 
		PRODUCT DIMENSIONS (w x d x h) 29" x 1.25" x 18.5" 73.7 x 3.2 x 47 cm	WEIGHT CAPACITY 130 lbs. 59 kg	TV SIZE 30" – 56"	
		MOUNTING PATTERN UNIVERSAL	FEATURE Arms can be padlocked for enhanced security		

FINISH OPTIONS	Black (B)	Silver (S)
-----------------------	-----------	------------

VISIONMOUNT® MEDIUM MOUNTS



« Full-motion and tilting mounts feature Virtual Axis™ technology for balanced tilting with the touch of a fingertip



« ML11 features innovative ClickStand™ to hold TV away from wall for easy cable access without having to remove TV



« Super Slim ML11 low-profile mount places TVs just .55" from wall — less than the width of a die



« Quick-release tabs on ML11 mounting brackets stay hidden, but pull down to unlock TV from wall plate for cable access









« Mounting brackets fit multiple VESA patterns to accommodate virtually every flat-panel TV from 15" to 42"



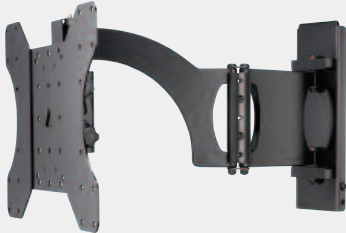



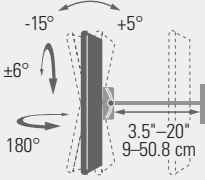

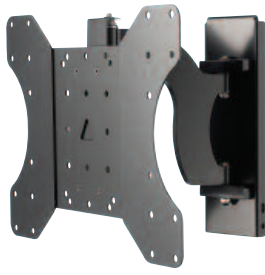

« VM400 has an aluminum hinged arm for maximum range of motion with rigid strength

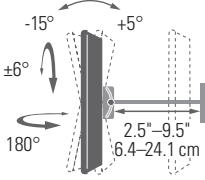



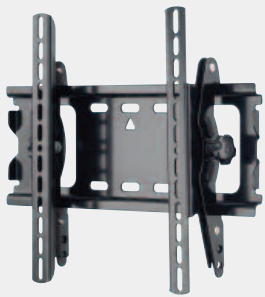

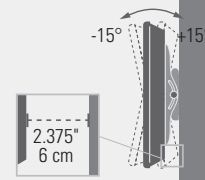

Model ML11-B1 in use

MODELS VM400b VM400s 	DESCRIPTION Full-motion Wall Mount for medium LCD TVs Allows $\pm 6^\circ$ lateral roll to ensure TV is perfectly level after hanging			  
	PRODUCT DIMENSIONS (w x d x h) 15" x 3.5"-20" x 12.75" 38.1 x 8.9-50.8 x 32.4 cm	WEIGHT CAPACITY 100 lbs. 45.4 kg	TV SIZE 26" - 42"	
	MOUNTING PATTERN VESA 100, 200 x 100, 200 x 200 300 x 200, 300 x 300, 400 x 300	FEATURE Arm can be padlocked for enhanced security		

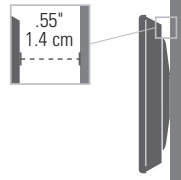
MODELS MF110-B1 MF110-S1 	DESCRIPTION Full-motion Wall Mount for medium LCD TVs Allows $\pm 6^\circ$ lateral roll to ensure TV is perfectly level after hanging			 
	PRODUCT DIMENSIONS (w x d x h) 13.25" x 2.5"-9.5" x 12.5" 33.7 x 6.4-24.1 x 31.8 cm	WEIGHT CAPACITY 100 lbs. 45.4 kg	TV SIZE 15" - 40"	
	MOUNTING PATTERN VESA 100, 200 x 100, 200 x 200 300 x 200, 300 x 300, 400 x 300	FEATURE Arm can be padlocked for enhanced security		

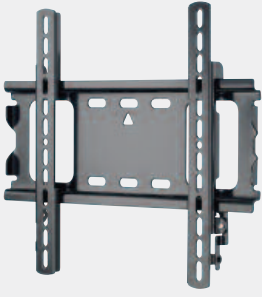
MODELS MT25-B1 MT25-S1 	DESCRIPTION Tilting Wall Mount for medium LCD TVs			 
	PRODUCT DIMENSIONS (w x d x h) 15.5" x 2.375" x 11.25" 39.4 x 6 x 28.6 cm	WEIGHT CAPACITY 100 lbs. 45.4 kg	TV SIZE 15" - 40"	
	MOUNTING PATTERN UNIVERSAL, including VESA 50, 75, 100, 200 x 200, 400 x 300, 400	FEATURE Arm can be padlocked for enhanced security		

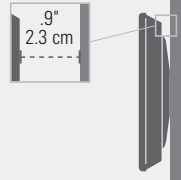
MODELS ML11-B1 ML11-S1 	DESCRIPTION Super Slim Low-Profile Mount for medium LCD TVs			 
	PRODUCT DIMENSIONS (w x d x h) 22.7" x .55" x 17.9" 57.7 x 1.4 x 45.4 cm	WEIGHT CAPACITY 100 lbs. 45.4 kg	TV SIZE 26" - 46"	
	MOUNTING PATTERN UNIVERSAL, including VESA 100, 200 x 100, 200 x 200, 300, 400 x 200, 400 x 400			

MODELS ML22-B1 ML22-S1 	DESCRIPTION Low-profile Wall Mount for medium LCD TVs			 
	PRODUCT DIMENSIONS (w x d x h) 15.5" x .9" x 10.75" 39.4 x 2.3 x 27.3 cm	WEIGHT CAPACITY 100 lbs. 45.4 kg	TV SIZE 15" - 40"	
	MOUNTING PATTERN UNIVERSAL, including VESA 50, 75, 100, 200, 400 x 300, 400 x 400	FEATURE Arm can be padlocked for enhanced security		

FINISH OPTIONS	 Black (B)	 Silver (S)
-----------------------	--	--

VISIONMOUNT® MEDIUM MOUNTS

« Virtual Axis™ 3D patented technology features a cup-shaped design that allows the mount and TV to move easily in every direction possible with totally fluid motion





« Built-in cable management system protects and conceals cables



« Keyholes on faceplate slide onto TV for effortless bracket alignment and easy installation; all mounting hardware included

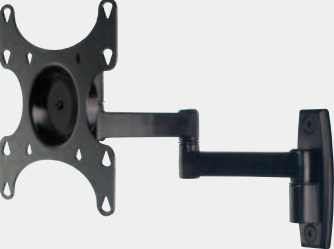

« Decorative caps hide mounting hardware for a finished appearance

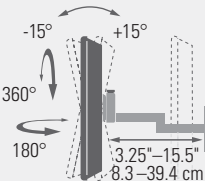

« Includes two VESA-compatible TV brackets:
Large TV bracket fits 200 x 200, 200 x 100 and 100 x 100;
small TV bracket fits 100 x 100 and 75 x 75

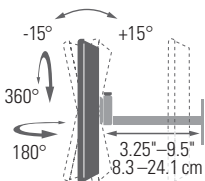
« Adjustment knob enables your TV to tilt and swivel easily without the use of tools, while maintaining tension for the perfect viewing angle

MODELS MF215-B1 MF215-S1		DESCRIPTION Full-motion Wall Mount for small and medium LCD TVs					
		PRODUCT DIMENSIONS (w x d x h) 11.25" x 3.25"-15.5" x 11.75" 28.6 x 8.3-39.4 x 29.8 cm	WEIGHT CAPACITY 60 lbs. 27.2 kg	TV SIZE 15" - 37"			
		MOUNTING PATTERN VESA 75, VESA 100, VESA 200 x 100, VESA 200 x 200					

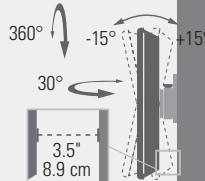
MODELS MF209-B1 MF209-S1		DESCRIPTION Full-motion Wall Mount for small and medium LCD TVs					
		PRODUCT DIMENSIONS (w x d x h) 11.75" x 3.25"-9.25" x 9.75" 29.8 x 8.3-23.5 x 24.8 cm	WEIGHT CAPACITY 60 lbs. 27.2 kg	TV SIZE 15" - 37"			
		MOUNTING PATTERN VESA 75, VESA 100, VESA 200 x 100, VESA 200 x 200					

MODELS MF203-B1 MF203-S1		DESCRIPTION Full-motion Wall Mount for small and medium LCD TVs					
		PRODUCT DIMENSIONS (w x d x h) 9.25" x 3.5" x 9.25" 36.8 x 8.9 x 23.5 cm	WEIGHT CAPACITY 60 lbs. 27.2 kg	TV SIZE 15" - 37"			
		MOUNTING PATTERN VESA 75, VESA 100, VESA 200 x 100, VESA 200 x 200					

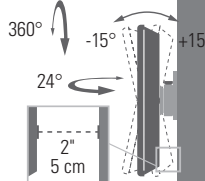
MODELS MF202-B1 MF202-S1		DESCRIPTION Full-motion Wall Mount for small and medium LCD TVs Features QuickConnect™					
		PRODUCT DIMENSIONS (w x d x h) 9.25" x 2" x 9.25" 23.5 x 5 x 23.5 cm	WEIGHT CAPACITY 60 lbs. 27.2 kg	TV SIZE 15" - 37"			
		MOUNTING PATTERN VESA 75, VESA 100, VESA 200 x 100, VESA 200 x 200					

FINISH OPTIONS

Black (B)

Silver (S)