

# CertainTeed SELECTS™

Vinyl Fence Systems



**CertainTeed**   
Quality made certain. Satisfaction guaranteed.™



# Bracketed Systems



## Newbury



- Size: 4' high x 8' wide
- Color: White
- Pickets: 7/8" x 3" thru-picket "good neighbor" design
- Picket Spacing: 2-15/16"

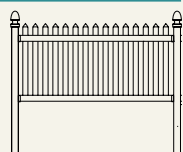

## Scalloped Newbury



- Size: 4' to 3-1/2' high x 8' wide
- Color: White
- Pickets: 7/8" x 3" thru-picket "good neighbor" design
- Picket Spacing: 2-15/16"

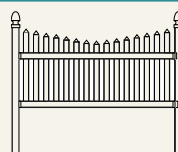

## Brookhaven



- Size: 6' high x 8' wide
- Color: White
- Pickets: 5/8" x 11-3/8" tongue & groove

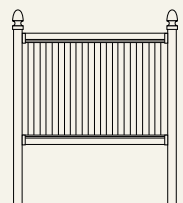

## Brookhaven with Lattice



- Size: 6' high x 8' wide
- Color: White
- Pickets: 5/8" x 11-3/8" tongue & groove

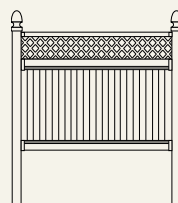

*Brookhaven bracketed fence styles are not recommended for areas where wind speeds exceed 60 mph. For high wind applications, the routed privacy system is recommended.*

## Features & Benefits

- Thru-pickets slide into routed rail – no screws or rivets
- **Preassembled sections reduce installation time**
- 11-3/8" tongue & groove pickets – wider pickets equals less installation time; tongue & groove feature eliminates section bracing
- **Larger 8' sections – require less labor and fewer posts than other fence products, providing a clean, continuous look**
- Panel mounting brackets – easy to install and provide installers flexibility for field applications
- Pre-formed channel rails make privacy assembly a snap
- Convenient section packs – assembled or unassembled
- Few parts and pieces – mounting brackets and blank posts eliminate complex parts list
- Simply choose your fence style, post and gate
- **Steel reinforced bottom rail eliminates sagging**
- Service 80% of your customers' needs with top sellers and provide a full range of fence products with our custom order program
- **"Good neighbor" design – attractive appearance on both sides of fence**
- Tongue & groove picket design on privacy styles
- Distinctive deco rail delivers the look of crown molding
- Matching gates available

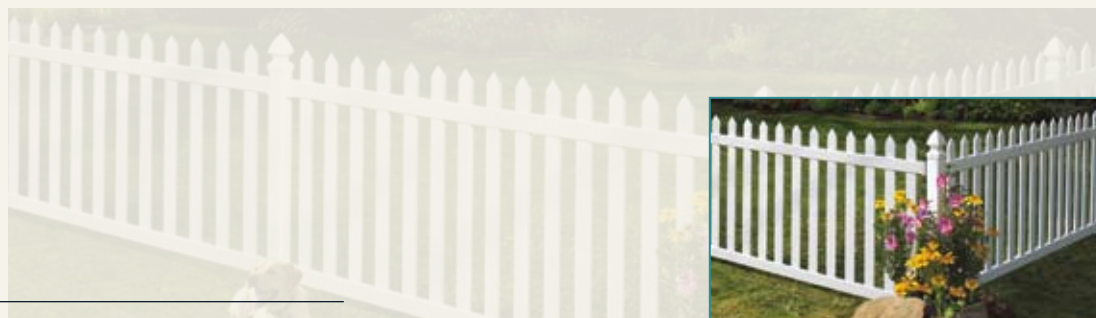



# Bracketed System Easy Ordering

## Parts List

**Newbury** 4' x 8' white  
**skus:** E20349 Pre-Assembled Section  
 E20351 OR Unassembled Section  
 E649575 Blank 4"x4"x75" Post  
 E60504 Bracket Pack  
 E262509 Pre-Assembled Gate  
 E70409 Gothic Post Cap

**Scalloped Newbury** 4' x 8' white  
**skus:** E20348 Pre-Assembled Section  
 E20350 OR Unassembled Section  
 E649575 Blank 4"x4"x75" Post  
 E60504 Bracket Pack  
 E262510 Pre-Assembled Gate  
 E70409 Gothic Post Cap

**Brookhaven** 6' x 8' white  
**skus:** E218004 Pre-Assembled Section  
 E218007 OR Unassembled Section  
 E5395096 Blank 5"x5"x96" Post  
 E60503 Bracket Pack  
 E656038 Pre-Assembled Gate  
 E70416 Gothic Post Cap  
 E70418 OR Flat Cap - External

**Brookhaven with Lattice** 6' x 8' white  
**skus:** E218005 Pre-Assembled Section  
 E218008 OR Unassembled Section  
 E5395096 Blank 5"x5"x96" Post  
 E60505 Bracket Pack  
 E656043 Pre-Assembled Gate  
 E70416 Gothic Post Cap  
 E70418 OR Flat Cap - External

### Optional Parts:

E27614 Drop Pin Kit for double gates (holds gate open or shut) - black  
 E70072 4"x4"x72" Aluminum Gate Post Stiffener  
 E70095 5"x5"x94" Aluminum Gate Post Stiffener

Pre-assembled gates include 2 uprights, self-closing hinges, latch, brace and hardware.

**EXAMPLE**

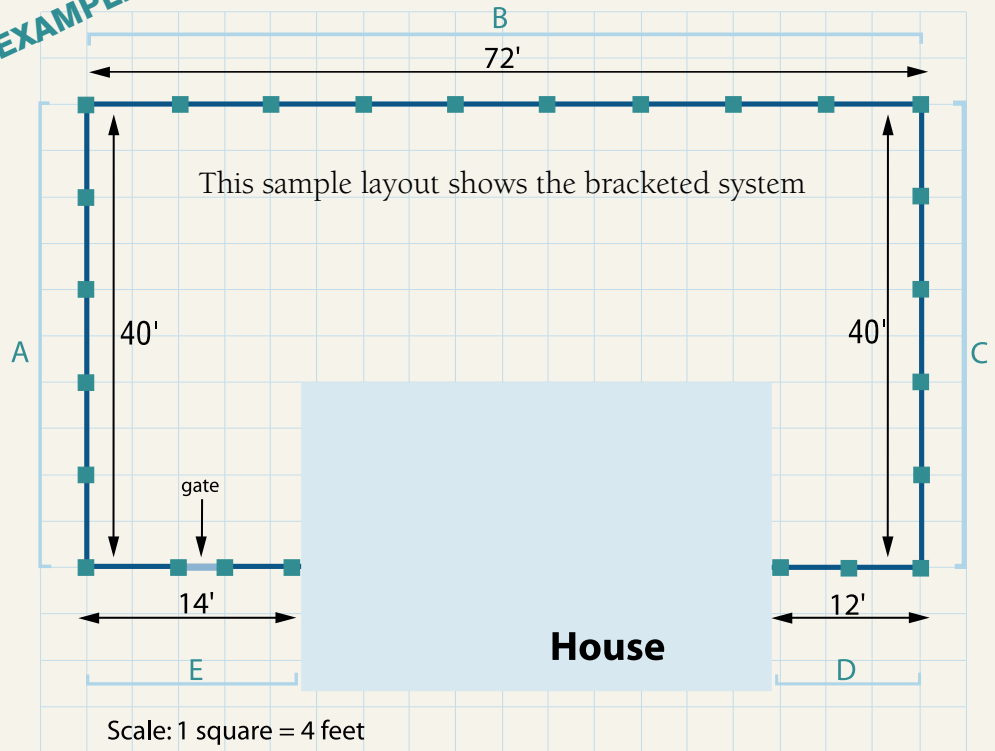

## To determine the materials you will need:

- Select a fence style.
- Decide pre-assembled or unassembled.
- Diagram your fence plan and include measurements.
- List measurements (in feet) and divide each by 8 feet (round up to nearest whole number).
- Total all sides. This total equals number of fence sections and bracket packs needed.
- Note total number of gates needed. Multiply by 2 for number of posts.

$$1 \text{ Gate} \times 2 = 2 \text{ gate posts} \\ = 1 \text{ gate}$$

- Add 1 to the total number of fence sections needed. Add number of gate posts needed. This is the total number of blank posts and post caps needed.

$$23 \text{ fence sections} \quad 23 \text{ fence sections}$$

$$+ 1 \quad + 1$$

$$+ 2 \text{ gate posts} \quad + 2 \text{ gate posts} \\ \hline 26 \text{ blank posts} \quad 26 \text{ post caps}$$

- Create material list referencing Parts List to the left.

	Qty	Parts List
fence sections	23	E20349
bracket packs	23	E60504
blank posts	26	E649575
post caps	26	E70409
gate	1	E262509

$$\text{Side A: } 40\text{ft.} \div 8 = 5 \\ \text{Side B: } 72\text{ft.} \div 8 = 9 \\ \text{Side C: } 40\text{ft.} \div 8 = 5 \\ \text{Side D: } 12\text{ft.} \div 8 = 1.50 (2) \\ \text{Side E: } 14\text{ft.} \div 8 = 1.75 (2)$$

- Total all sides. This total equals number of fence sections and bracket packs needed.

$$\text{Side A: } 5 \\ \text{Side B: } 9 \\ \text{Side C: } 5 \\ \text{Side D: } 2 \\ \text{Side E: } 2$$

$$\text{Total: } 23 \text{ sections} \\ 23 \text{ bracket packs}$$



# Routed Systems

## Arlington Smooth



- Sizes: 5' & 6' high x 8' wide
- Colors: White, Tan (shown)
- Pickets: 7/8" x 7" tongue & groove

## Arlington with Lattice



- Sizes: 6' high x 8' wide
- Colors: White, Tan
- Pickets: 7/8" x 7" tongue & groove

## Arlington with CertaGrain® texture

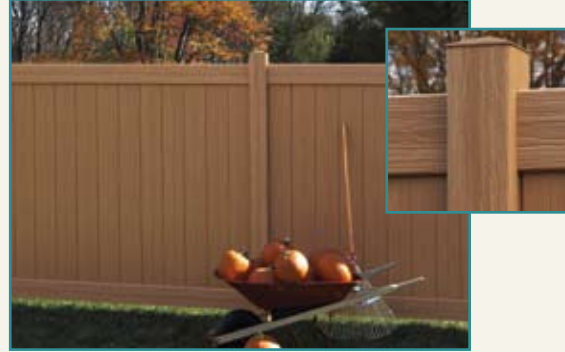

- Sizes: 5' & 6' high x 8' wide
- Color: Sierra Blend
- Pickets: 7/8" x 7" tongue & groove

## Features & Benefits

### Privacy channeled rails

- Fence section can be racked to follow the slope of the terrain
- Ensures a safe, secure picket attachment with no glue or screws

### Routed fence post

- Superior aesthetics
- More secure connection allows for thermal expansion season after season

### Routed rails

- Fence section can be racked to follow the slope of the terrain
- Precision routed for a clean, professional finish
- Ensures a safe, secure picket attachment

### Heavyweight pickets

- Provide superior impact strength, resist warping and oil canning of flat panel fence
- Offering includes both profile and tongue & groove designs

### Steel reinforced bottom rail

- Eliminates sagging and bowing for a stronger fence
- Hour-glass design grips the end pickets to add stiffness

## Newport



- Sizes: 3' & 4' high x 6' wide
- Color: White
- Pickets: 7/8" x 3" pointed
- Picket Spacing: 2-7/16"

## Scalloped Newport



- Sizes: 3', 4' & 5' high x 6' wide
- Color: White
- Pickets: 7/8" x 3" pointed
- Picket Spacing: 2-7/16"

## Bel Air



- Sizes: 4', 5' & 6' high x 8' wide (5' & 6' height include midrail)
- Colors: White, Tan
- Pickets: 7/8" x 3"
- Picket Spacing: 7/16"

## Wilshire



- Sizes: 3', 4', 5' & 6' high x 8' wide (5' & 6' height include midrail)
- Colors: White, Tan
- Pickets: 7/8" x 1-1/2" pointed
- Picket Spacing: 3-5/8"



# Post & Rail Systems



## Post & Rail Smooth



- Sizes: 2 rail, 3 rail & 4 rail
- Colors: White, Tan

## Post & Rail with CertaGrain® texture



- Sizes: 2 rail, 3 rail & 4 rail
- Color: White

## Features & Benefits

CertainTeed's Post & Rail fencing provides a safe, reliable enclosure for horses and other livestock. Available with CertaGrain® texture, our post & rail fence offers the authentic look of painted wood fencing with the durability, low maintenance and proven performance of CertainTeed's premium vinyl design.

- Available in two finishes: CertaGrain and Smooth
- Safe and durable horse enclosure
- Economical and virtually maintenance free
- Made in the U.S.A.

Rails come in 1-1/2" x 5-1/2" size and 8' and 16' lengths, 8' section width

CertaGrain texture only offered on 1-1/2" x 5-1/2" (Post & Rail styles - White only)

Smooth finish offered on 1-1/2" x 5-1/2" (Post & Rail styles - White and Tan colors)

## Spacing

For complete instruction detail, refer to CertainTeed Selects Installation Manual.

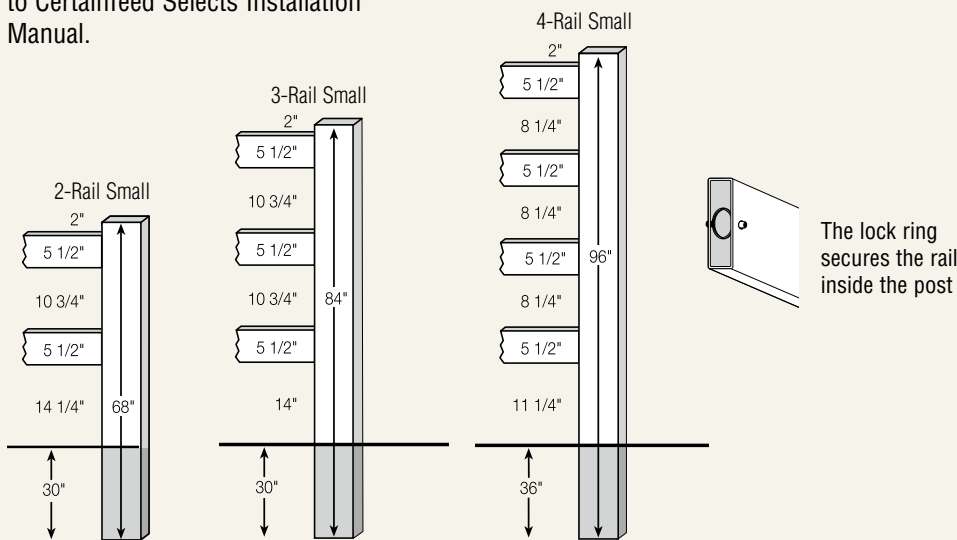



# Arbors

## Aristocrat II



- Outside Dimension  
91"h x 72"w x 31"d
- Inside Dimension  
78-1/2"h x 58"w x 31"d
- Color: White

## Baumont II



- Outside Dimension  
96"h x 57"w x 32"d
- Inside Dimension  
90"h x 49"w x 32"d
- Color: White

## Vineyard Pergola



- Outside Dimension  
93"h x 89"w x 54"d
- Inside Dimension  
84"h x 48"w x 54"d
- Color: White

## Features & Benefits

Complement your CertainTeed Selects fence with an easy-care vinyl arbor. Choose from three elegant styles that add a personal touch to any outdoor setting.

- Easy assembly
- No tools required
- Virtually maintenance free
- Strong and durable
- Made in the U.S.A.



Printed on FSC-certified paper.



Aristocrat II arbor shown with Scalloped Newbury fence.

Style may vary slightly from photo.

## ASK ABOUT OUR OTHER CERTAINTEED PRODUCTS AND SYSTEMS:

**EXTERIOR:** ROOFING • SIDING • WINDOWS • FENCE • RAILING • TRIM • DECKING • FOUNDATIONS • PIPE  
**INTERIOR:** INSULATION • GYPSUM • CEILINGS

CertainTeed Corporation  
 P.O. Box 860  
 Valley Forge, PA 19482

Professional: 800-233-8990  
 Consumer: 800-782-8777  
[www.certainteed.com](http://www.certainteed.com)

