

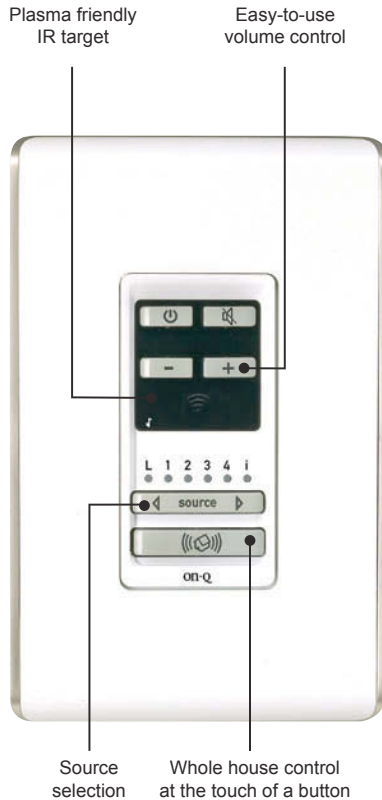

lyriQ™ Multi-Room Audio System in the Studio Design

Now available in the new Studio design, the lyriQ Multi-Room Audio System delivers high performance sound at the touch of a button. Installed easily via Cat 5 wiring, lyriQ systems are available in multi-source or single source versions. Each multi-source system can control up to eight zones of audio, with the ability to cascade additional modules for larger installations.





System Features and Benefits

- Up to four sources per multi-source system
- Up to eight zones per multi-source system, with ability to expand
- Whole house control via universal remote and keypad
- High performance and standard systems
- Up to two local source inputs per keypad
- Local source selectable via keypads
- Elegant, contemporary design
- Efficient installation via Cat 5 wiring

COLORS



RELATED PRODUCTS



AU5008-XX
LyriQ Local Source
Input



AU5009-XX
LyriQ Keypad



AU5010-XX
LyriQ High Performance
Keypad



AU5544-XX
LyriQ Multi-Source, Four-Zone Kit

WIRING DIAGRAM

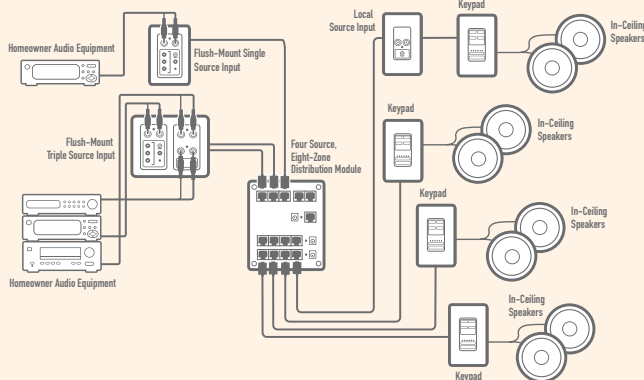

INSTALLATION AT-A-GLANCE lyriQ MULTI-SOURCE AUDIO SYSTEM

1. Run a single Cat 5 cable and 16/4 speaker wire to each location where a keypad will be installed.
2. Install each keypad in a standard single gang box and connect a pair of speakers to the keypad.
3. Install the multi-source distribution module in the On-Q enclosure and connect it to the keypads.
4. Run a Cat 5 cable from the module to each location where a flush-mount source input will be installed.
5. Install the flush mount inputs in standard single or double gang boxes and connect the Cat 5.
6. Connect the source to the input.



lyriQ™ HIGH PERFORMANCE KITS

PRODUCT	PART #	DESCRIPTION
<p>lyriQ High Performance Multi-Source, 6-Zone Kit in Studio Design</p>  <p>HIGH PERFORMANCE</p>	AU5646-WH	<p>With this lyriQ High Performance Audio Kit, homeowners can relax throughout the home to the crisp, clear sounds of their favorite artists. They can entertain in six different rooms or zones without missing a single riff. The kit includes six high performance keypads with 20 W per channel (class D) power and active subwoofer support, providing superior performance and fidelity throughout the home.</p> <p>Kit Contains:</p> <ul style="list-style-type: none"> 6 lyriQ High Performance Keypads with Studio Plates 2 High Performance Power Distribution Modules 1 lyriQ Flush Mount Single Source Input 1 lyriQ Flush Mount Triple Source Input 1 lyriQ Four Source, Eight-Zone Distribution Module 1 Remote 2 Dual IR Emitters 4 Power Supplies 1 Single-Gang Studio Wall Plate 1 Double-Gang Studio Wall Plate
<p>lyriQ High Performance Multi-Source, 4-Zone Kit in Studio Design</p>  <p>HIGH PERFORMANCE</p>	AU5644-WH	<p>This lyriQ High Performance Kit is the perfect way to provide serious audiophile sound in a smaller package. Homeowners can enjoy high-fidelity audio from four different sources in four different rooms or zones, including the patio. The kit includes four high performance keypads with 20 W per channel (class D) power and active subwoofer support, providing superior performance and fidelity throughout the home.</p> <p>Kit Contains:</p> <ul style="list-style-type: none"> 4 lyriQ High Performance Keypads with Studio Plates 1 High Performance Power Distribution Module 1 lyriQ Flush Mount Single Source Input 1 lyriQ Flush Mount Triple Source Input 1 lyriQ Four Source, Eight-Zone Distribution Module 1 Remote 2 Dual IR Emitters 3 Power Supplies 1 Single-Gang Studio Wall Plate 1 Double-Gang Studio Wall Plate

WIRING DIAGRAM

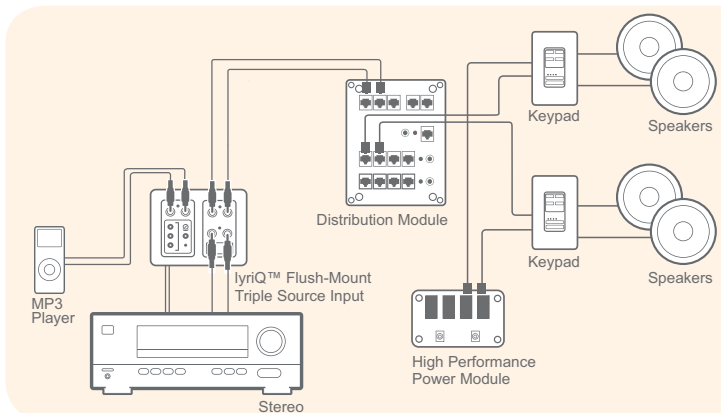



INSTALLATION AT-A-GLANCE
lyriQ HIGH PERFORMANCE AUDIO SYSTEM



1. Run a Cat 5 cable and 16/4 speaker wire to any location where a keypad will be installed.
2. Install each keypad in a single gang box and connect a pair of speakers to the keypad.
3. Install the power module and multi-source distribution module in the On-Q enclosure.
4. Connect the Cat 5 cables from the keypads to the power module and the distribution module.
5. Run a Cat 5 cable from the distribution module to each location where a source input will be installed. Connect the source to the source input.



lyriQ™ KITS





PRODUCT	PART #	DESCRIPTION										
<p>lyriQ Multi-Source, 4-Zone Kit in Studio Design</p>  <p>MULTI-SOURCE</p>	AU5544-WH	<p>This lyriQ Audio Kit lets homeowners enjoy four music sources throughout their home. Its Cat 5 backbone allows whole house commands and it easily integrates with the Broadcast or Selective Call Intercom Systems. It passes Infrared remote control signals for easy sound management and, because it's Cat 5-based, installation is simple.</p> <p>Kit Contains:</p> <table border="0"> <tr> <td>4 lyriQ Keypads with Studio Plates</td> <td>1 Remote</td> </tr> <tr> <td>1 lyriQ Local Source Input with Studio Plate</td> <td>2 Dual IR Emitters</td> </tr> <tr> <td>1 lyriQ Flush Mount Single Source Input</td> <td>1 Power Supply</td> </tr> <tr> <td>1 lyriQ Flush Mount Triple Source Input</td> <td>1 Single-Gang Studio Wall Plate</td> </tr> <tr> <td>1 lyriQ Four Source, Eight-Zone Distribution Module</td> <td>1 Double-Gang Studio Wall Plate</td> </tr> </table>	4 lyriQ Keypads with Studio Plates	1 Remote	1 lyriQ Local Source Input with Studio Plate	2 Dual IR Emitters	1 lyriQ Flush Mount Single Source Input	1 Power Supply	1 lyriQ Flush Mount Triple Source Input	1 Single-Gang Studio Wall Plate	1 lyriQ Four Source, Eight-Zone Distribution Module	1 Double-Gang Studio Wall Plate
4 lyriQ Keypads with Studio Plates	1 Remote											
1 lyriQ Local Source Input with Studio Plate	2 Dual IR Emitters											
1 lyriQ Flush Mount Single Source Input	1 Power Supply											
1 lyriQ Flush Mount Triple Source Input	1 Single-Gang Studio Wall Plate											
1 lyriQ Four Source, Eight-Zone Distribution Module	1 Double-Gang Studio Wall Plate											
<p>lyriQ Single Source, 4-Zone Kit in Studio Design</p>  <p>SINGLE SOURCE</p>	AU5514-WH	<p>The lyriQ Single Source, 4-Zone Kit allows homeowners to enjoy the main music source in four rooms, or choose to listen to a local source in only one room. Its Cat 5 backbone allows whole house commands and passes Infrared remote control signals for easy sound management.</p> <p>Kit Contains:</p> <table border="0"> <tr> <td>4 lyriQ Keypads with Studio Plates</td> <td>1 Remote</td> </tr> <tr> <td>1 lyriQ Local Source Input with Studio Plate</td> <td>1 Dual IR Emitter</td> </tr> <tr> <td>1 lyriQ Flush Mount Single Source Input</td> <td>1 Power Supply</td> </tr> <tr> <td>1 lyriQ Advanced Single Source, Four-Zone Distribution Module</td> <td>1 Single-Gang 1 lyriQ Studio Wall Plate</td> </tr> </table>	4 lyriQ Keypads with Studio Plates	1 Remote	1 lyriQ Local Source Input with Studio Plate	1 Dual IR Emitter	1 lyriQ Flush Mount Single Source Input	1 Power Supply	1 lyriQ Advanced Single Source, Four-Zone Distribution Module	1 Single-Gang 1 lyriQ Studio Wall Plate		
4 lyriQ Keypads with Studio Plates	1 Remote											
1 lyriQ Local Source Input with Studio Plate	1 Dual IR Emitter											
1 lyriQ Flush Mount Single Source Input	1 Power Supply											
1 lyriQ Advanced Single Source, Four-Zone Distribution Module	1 Single-Gang 1 lyriQ Studio Wall Plate											

lyriQ™ DISTRIBUTION MODULES

PRODUCT	PART #	DESCRIPTION	DIMENSIONS
<p>lyriQ Four-Source, Eight-Zone Distribution Module</p> 	AU1002	<p>The lyriQ Four Source, Eight-Zone Distribution Module distributes four audio sources to up to eight different zones. It also includes built-in audio interrupt for On-Q Intercom Systems, and can be used to expand a system to up to 32 rooms.</p> <p>Bracket included. Power supply required (see page 41).</p>	5.9" H x 6.5" W
<p>lyriQ Single Source, 4-Zone Distribution Module</p> 	AU7396	<p>The lyriQ Single Source, Four-Zone Distribution Module provides high-quality stereo music to four rooms, with the ability to expand to 16 rooms. It also includes built-in audio interrupt for On-Q Intercom Systems, and can be used to expand a system to up to 32 rooms.</p> <p>Bracket included. Power supply required (see page 41).</p>	3" H x 6.5" W
<p>lyriQ Advanced Single Source Distribution Module</p> 	AU1014	<p>The lyriQ Advanced Single Source Distribution Module allows you to connect the whole house audio to the Integration Module. It distributes audio from one analog source and supports four to sixteen rooms.</p> <p>Bracket included. Power supply required (see page 41).</p>	3" H x 6.5" W



LYRIQ™ SOURCE INPUTS





PRODUCT	PART #	DESCRIPTION	DIMENSIONS
<p>lyriQ Local Source Input in Studio Design</p> 	<p>AU5008-GB AU5008-LA AU5008-TI AU5008-WH</p>	<p>The lyriQ Local Source Input enables users to plug in devices like personal audio players locally for in-room entertainment. It includes a convenient RJ45 connection and adjustable gain control. Up to two local source inputs can be installed per zone, and it can be selected from the studio keypad or the On-Q remote.</p> <p>Includes Studio Wall Plate.</p>	<p>4.2" H x 1.65" W</p>
<p>lyriQ Flush Mount Triple Source Input</p> 	<p>AU1011-BK AU1011-LA AU1011-WH</p>	<p>The lyriQ Flush Mount Triple Source Input connects to the Four-Source, Eight-Zone Module to distribute three audio sources throughout the home. It features two RJ45 connections, adjustable gain control for each input, three IR emitter ports and one IR target port. Pair with the lyriQ Single Source Input in flush-mount or standard versions (AU1004 or F7398).</p>	<p>4.2" H x 3.3" W</p>
<p>lyriQ Flush Mount Single Source Input</p> 	<p>AU1004-BK AU1004-LA AU1004-WH</p>	<p>The lyriQ Flush Mount Single Source Input connects to a lyriQ distribution module to distribute one audio source throughout the home. It features an RJ45 connection, adjustable gain control, an IR emitter port and an IR target port.</p>	<p>4.2" H x 1.65" W</p>
<p>lyriQ Triple Source Input</p> 	<p>F7428</p>	<p>The lyriQ Triple Source Input connects to the Four-Source, Eight-Zone Module to distribute three audio sources throughout the home. It features two RJ45 connections, adjustable gain control for each input, three IR emitter ports and one IR target port. Pair with the lyriQ Single Source Input in flush-mount or standard versions (AU1004 or F7398).</p>	<p>2.45" H x 4.5" W x 1.25" D</p>
<p>lyriQ Single Source Input</p> 	<p>F7398</p>	<p>The lyriQ Single Source Input connects to a lyriQ distribution module to distribute one audio source throughout the home. It features an RJ45 connection, adjustable gain control, an IR emitter port and an IR target port.</p>	<p>2.45" H x 4.5" W x 1.25" D</p>

COLOR OPTIONS





lyriQ™ COMPONENTS

PRODUCT	PART #	DESCRIPTION	DIMENSIONS
lyriQ High Performance Keypad in Studio Design 	AU5010-GB AU5010-LA AU5010-TI AU5010-WH	The lyriQ High Performance Keypad is perfect for applications requiring superior power and fidelity. The keypad features enhanced performance with 20 W per channel (class D) power and active subwoofer support with an 80 Hz low pass filter. The keypad includes backlit buttons to indicate unit status, and an RJ45 connection for easy, Cat 5-based installation. Includes Studio Wall Plate. lyriQ High Performance Keypad Power Distribution Module (AU1001) required.	4.2" H x 1.65" W
lyriQ Keypad in Studio Design 	AU5009-GB AU5009-LA AU5009-TI AU5009-WH	The keypad delivers high quality sound throughout the home. It features enhanced performance with an efficient 15 W, class D amplifier, as well as convenient backlit buttons to indicate unit status. The keypad also enables direct selection of the local source, as well as a convenient whole house button and an RJ45 connection for easy Cat 5-based installation. Includes Studio Wall Plate.	4.2" H x 1.65" W
lyriQ Zone Expander 	AU1022	This product expands an eight-zone, multi-source lyriQ system to create up to 16 zones of audio. Designed to be connected to two four-source, eight-zone distribution modules, the zone expander includes convenient RJ45 connections and does not require any additional power.	3" H x 6.5" W
lyriQ Zone Expander with Integration 	AU1023 NEW!	This product features the same functionality as the AU1022, but can also be used with the Integration Module to connect to the Unity Home System.	3" H x 6.5" W

ACCESSORIES

PRODUCT	PART #	DESCRIPTION
Home Systems Remote 1060 	AU1060	The On-Q Remote features whole house commands which control all keypads from one location. It controls the lyriQ Audio System, as well as other On-Q systems. The universal learning remote can also be programmed to control up to seven additional devices.
Dual IR Mouse Emitter	F7425	Includes 3.5 mm mono mini plug for connection to any lyriQ Source Input. Emitter installs directly over IR sensor window for control of source equipment from the keypad or universal remote.
Universal IR Target	AC1016	Enables control of multimedia equipment in locations without a volume control, such as when equipment is stored inside the entertainment center.