

SPECIFICATION: BLÜCHER BFD-510-SO AISI Type 304 stainless steel floor drain with 8" (200) round top with surface membrane clamp, 1/8" (3) grating (standard), and no hub side outlet.

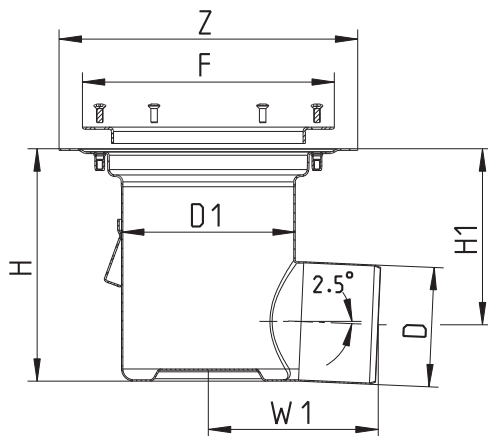

Side Outlet



Optional Gratings			
	Suffix	Description	
	-None	1/8" (Standard)	<input type="checkbox"/>
	-LG	Ladder Grating	<input type="checkbox"/>
	-MG	Mesh Grating	<input type="checkbox"/>
	-SG	Slot Grating	<input type="checkbox"/>

Options		
Suffix	Description	
-316	Type 316 Stainless Steel	<input type="checkbox"/>
-B	Sediment Basket	<input type="checkbox"/>
-P	Stainless Steel P-Trap	<input type="checkbox"/>
-SB	Sand Bucket	<input type="checkbox"/>
-TPT	Trap Primer Tapping	<input type="checkbox"/>
-VP	Grate Secured w/Vandal Proof Screws	<input type="checkbox"/>
-W	Water Trap	<input type="checkbox"/>

Dimensional Chart

Model No.	Pipe Size D	D1	Top Size F	Z	H	H1	W1
BFD-513-SO	3"(75)	6"(160)	9-1/8"(232)	10-13/16"(275)	8-7/16"(214)	7-1/8"(181)	9-15/16"(253)
BFD-514-SO	4"(110)	6"(160)	9-1/8"(232)	10-13/16"(275)	8-7/16"(214)	6-3/8"(162)	6-3/16"(156)

Job Name _____ Contractor _____

Job Location _____ Approval _____

Engineer _____ Contractor's P.O. No. _____

Approval _____ Representative _____