

REM-PACK-16

Sixteen Remote Control Kit

Technical Specifications

The Intelix REM-PACK-16 is a complete, pre-programmed remote control system including wiring accessories, IR to serial control modules, and push-button remote controls. Designed for the Intelix Audisey Athena matrix mixer/amplifier, the REM-PACK-16 features visual and auditory feedback, multiple label options, and password protection.

Specifications

Kit Contents

- (16) CB-1000 remote controls
- (1) Ion-LT IR/serial controller
- (16) CW-TB wiring blocks
- (17) 12VDC power supplies
- (16) 24-sheet CB-1000 button caps
- (16) single gang decora plates
- (16) 6' IR cables
- (16) IR breakout cables
- (1) Athena Designer Software CD

ION-LT Dimensions

CW-TB Dimensions

CB-1000 Dimensions

CB-1000 Form Factor

Regulatory

5.10"H x 2.50"W x 1.10"D

1.75"H x 2.00"W x 0.50"D

4.25"H x 2.38"W x 1.25"D

Single-gang decora

UL, RoHS

CB-1000 Feedback

CB-1000 Security

Power Supplies

CB-1000 Max Power Consumption

ION-LT Max Power Consumption

CB-1000 Current-Limiting Resistor

Shipping Weight

Warranty

Ordering Information

Audible button click; button backlighting

Built-in passcode

12 VDC

100 mA

285 mA

360 Ohm/ 8 mA drive

16 lbs.

2 years

REM-PACK-16

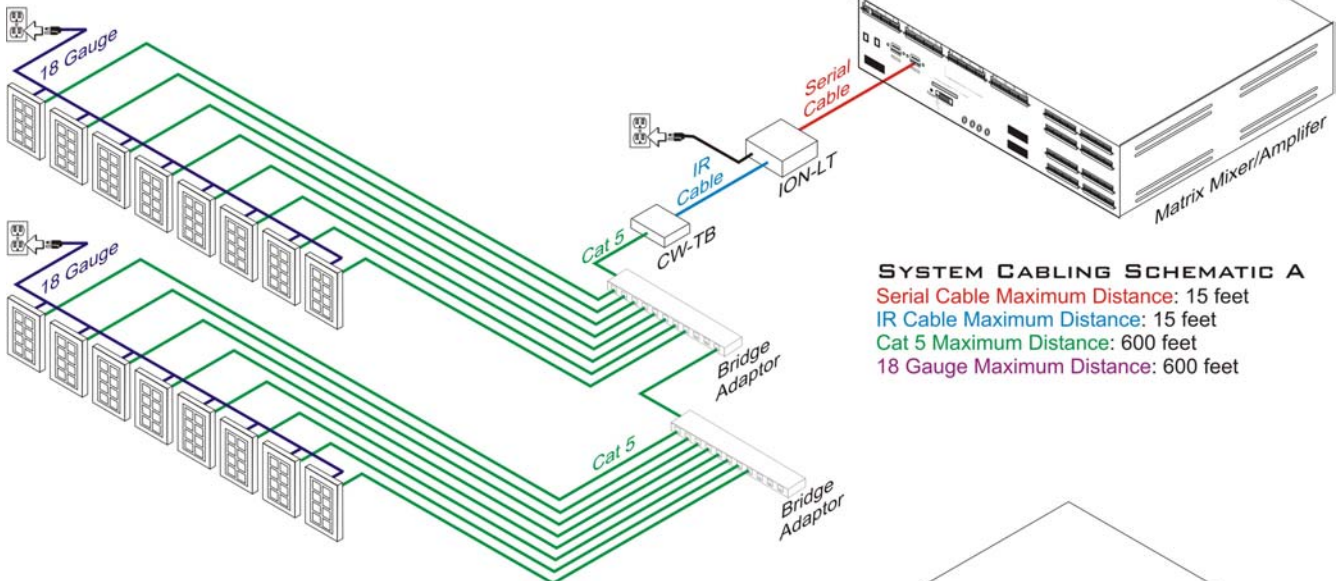

SYSTEM CABLING SCHEMATIC A

Serial Cable Maximum Distance: 15 feet

IR Cable Maximum Distance: 15 feet

Cat 5 Maximum Distance: 600 feet

18 Gauge Maximum Distance: 600 feet

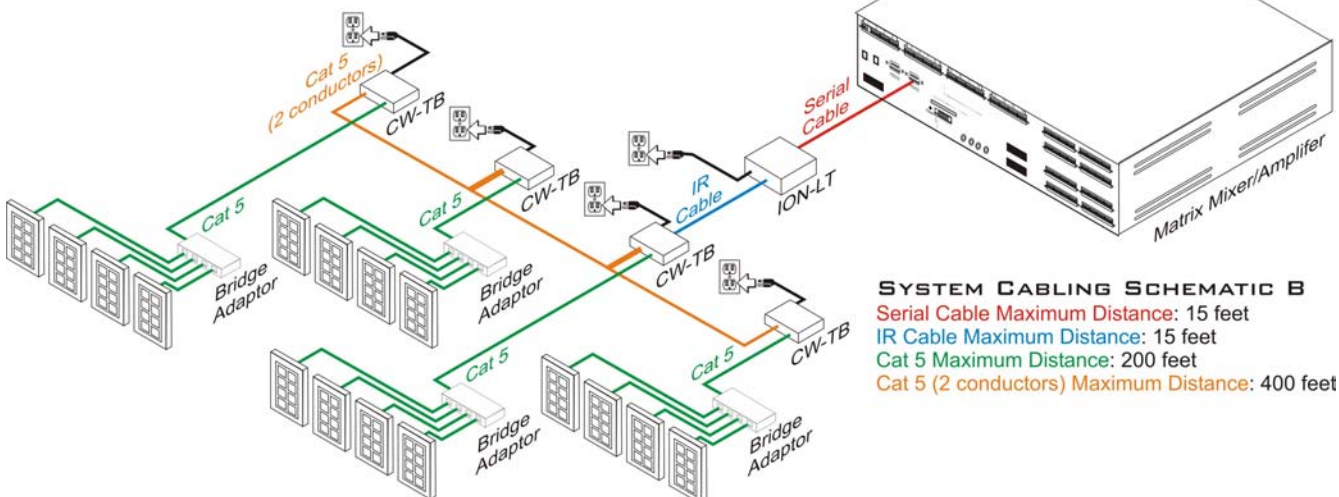

SYSTEM CABLING SCHEMATIC B

Serial Cable Maximum Distance: 15 feet

IR Cable Maximum Distance: 15 feet

Cat 5 Maximum Distance: 200 feet

Cat 5 (2 conductors) Maximum Distance: 400 feet

*Matrix mixer/amplifier, cabling, and bridge adaptor sold separately. Intelix recommends Intelix Comet-BA4 and the Comet-BA11 bridge adaptors.

www.intelix.com

intelix
DESIGN WITH INTELLIGENCE

2222 Pleasant View Road
Suite #1
Middleton, WI 53562

Phone: 608-831-0880
Toll-Free: 1-866-4-MATMIX
Fax: 608-831-1833

REM-PACK-16

Sixteen Remote Control Kit

Technical Specifications

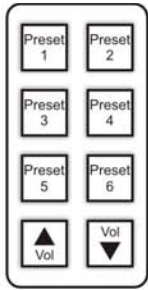

Remote 1 Programming

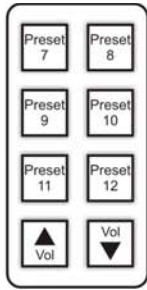

Remote 2 Programming

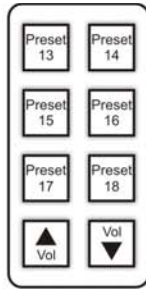

Remote 3 Programming

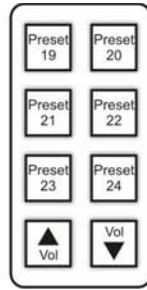

Remote 4 Programming

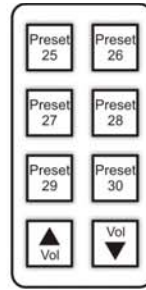

Remote 5 Programming

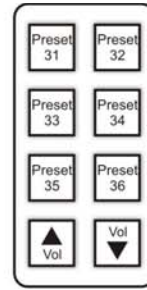

Remote 6 Programming

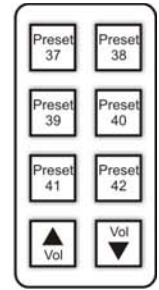

Remote 7 Programming

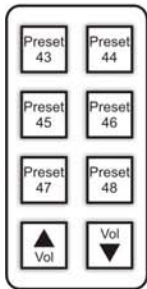

Remote 8 Programming

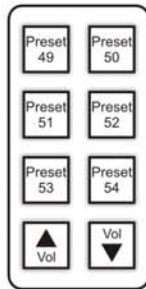

Remote 9 Programming

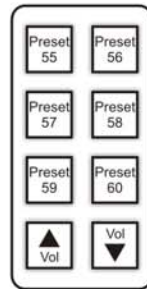

Remote 10 Programming

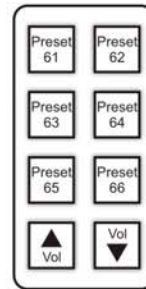

Remote 11 Programming

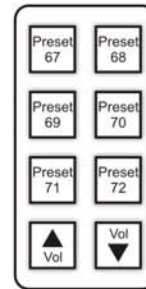

Remote 12 Programming

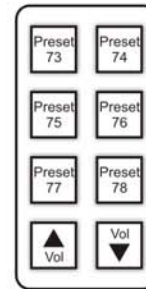

Remote 13 Programming

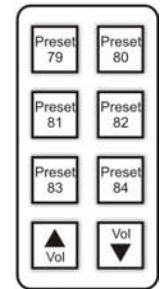

Remote 14 Programming

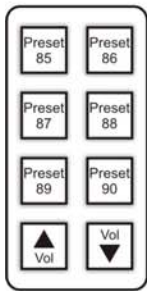

Remote 15 Programming

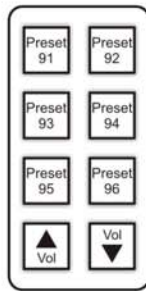

Remote 16 Programming

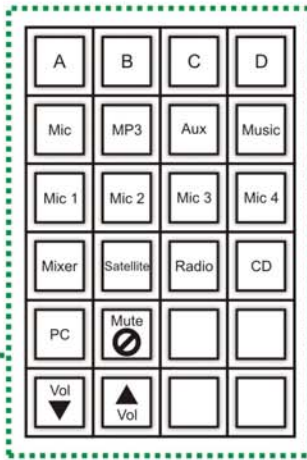

▲ Each eight button remote control arrives labeled and pre-programmed with each button tied to a customizable Intelix Audisey Athena software preset.

◀ Each remote control includes 24 button caps for custom labeling.

Each remote control fits in a standard single-gang wallbox with a standard decora plate. ▶

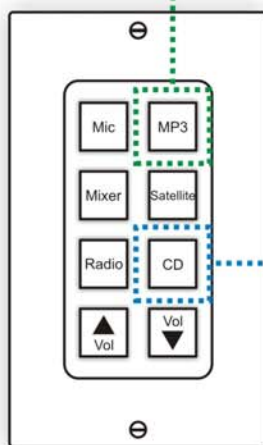

To adjust the remote control's programming, simply reconfigure the system preset in the Intelix Audisey Athena Designer Software. System presets may include input Digital Signal Processing (DSP) and output Digital Signal Processing presets. ▼

