

REM-PACK-6

Six Remote Control Kit

Technical Specifications

The Intelix REM-PACK-6 is a complete, pre-programmed remote control system including wiring accessories, IR to serial control modules, and push-button remote controls. Designed for the Intelix Audisey Athena matrix mixer/amplifier, the REM-PACK-6 features visual and auditory feedback, multiple label options, and password protection.

Specifications

Kit Contents

- (6) CB-1000 remote controls
- (1) Ion-LT IR/serial controller
- (6) CW-TB wiring blocks
- (7) 12VDC power supplies
- (6) 24-sheet CB-1000 button caps
- (6) single gang decora plates
- (6) 6' IR cables
- (6) IR breakout cables
- (1) Athena Designer Software CD

ION-LT Dimensions

5.10"H x 2.50"W x 1.10"D

CW-TB Dimensions

1.75"H x 2.00"W x 0.50"D

CB-1000 Dimensions

4.25"H x 2.38"W x 1.25"D

CB-1000 Form Factor

Single-gang decora

Regulatory

UL, RoHS

CB-1000 Feedback

Audible button click; button backlighting

CB-1000 Security

Built-in passcode

Power Supplies

12 VDC

CB-1000 Max Power Consumption

100 mA

ION-LT Max Power Consumption

285 mA

CB-1000 Current-Limiting Resistor

360 Ohm/ 8 mA drive

Shipping Weight

16 lbs.

Warranty

2 years

Ordering Information

REM-PACK-6

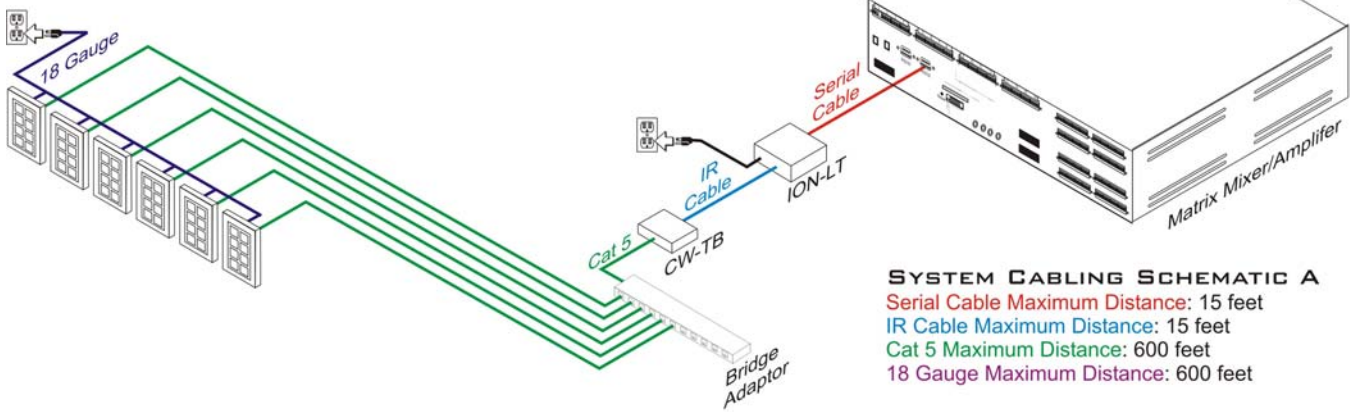

SYSTEM CABLING SCHEMATIC A

Serial Cable Maximum Distance: 15 feet

IR Cable Maximum Distance: 15 feet

Cat 5 Maximum Distance: 600 feet

18 Gauge Maximum Distance: 600 feet

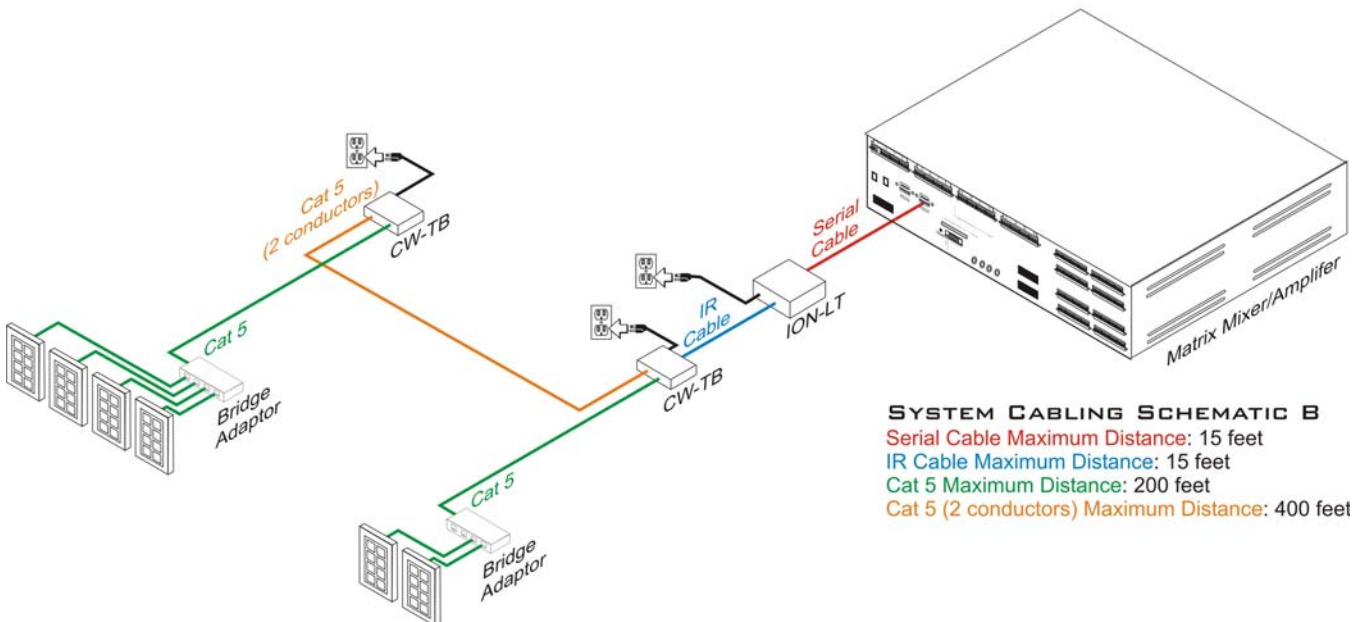

SYSTEM CABLING SCHEMATIC B

Serial Cable Maximum Distance: 15 feet

IR Cable Maximum Distance: 15 feet

Cat 5 Maximum Distance: 200 feet

Cat 5 (2 conductors) Maximum Distance: 400 feet

*Matrix mixer/amplifier, cabling, and bridge adaptor sold separately. Intelix recommends Intelix Comet-BA4 and the Comet-BA11 bridge adaptors.

www.intelix.com

intelix
DESIGN WITH INTELLIGENCE

2222 Pleasant View Road
Suite #1
Middleton, WI 53562

Phone: 608-831-0880
Toll-Free: 1-866-4-MATMIX
Fax: 608-831-1833

REM-PACK-6

Six Remote Control Kit

Technical Specifications

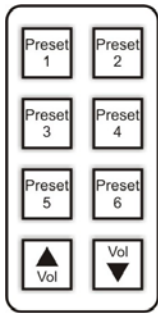

Remote 1
Programming

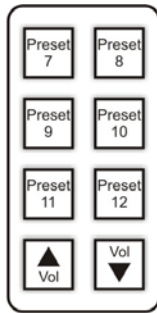

Remote 2
Programming

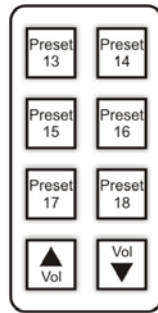

Remote 3
Programming

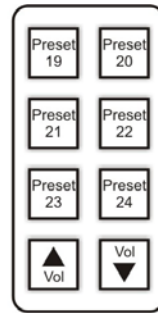

Remote 4
Programming

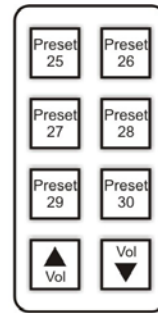

Remote 5
Programming

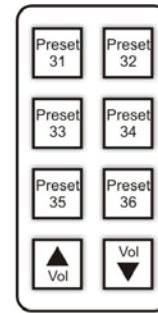

Remote 6
Programming

▲ Each eight button remote control arrives labeled and pre-programmed with each button tied to a customizable Intelix Audisey Athena software preset.

Each remote control fits in a standard single-gang wallbox with a standard decora plate. ▼

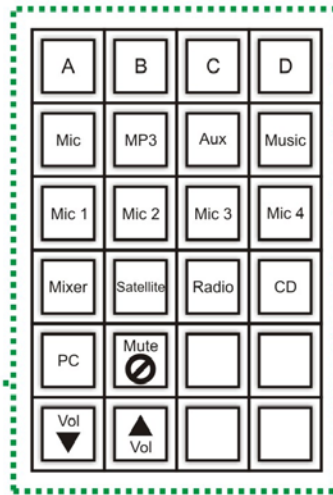
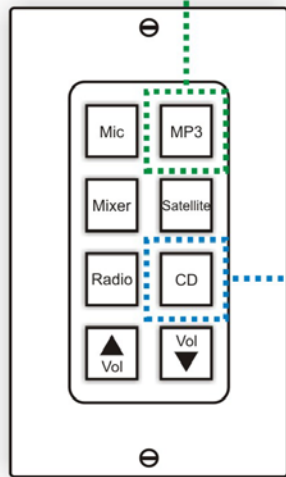

◀ Each remote control includes 24 button caps for custom labeling.

To adjust the remote control's programming, simply reconfigure the system preset in the Intelix Audisey Athena Designer Software. System presets may include input Digital Signal Processing (DSP) and output Digital Signal Processing presets. ▼

