

FS1730 SERIES 12" x 12" x 8" DEEP FLOOR SINK

FS1730 SERIES

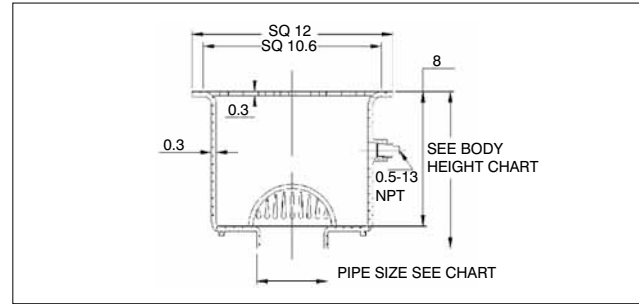
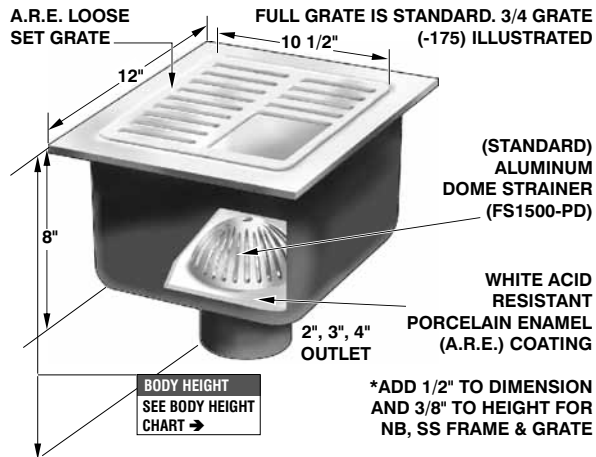

FS1730 SERIES BODY HEIGHT

PIPE SIZE	NO HUB STANDARD	PUSH ON (P)	INSIDE CAULK (X)	THREADED (T)	PVC (-30)	ABS (-31)
2"	10 5/8"	11 1/8"	10 5/8"	10 1/8"	11 5/8"	11 5/8"
3"	10 5/8"	11 1/8"	10 5/8"	10 1/2"	11 5/8"	11 5/8"
4"	10 5/8"	11 1/8"	10 5/8"	10 1/2"	11 5/8"	11 5/8"

A.R.E. CAST IRON BODY WITH FULL GRATE & ALUMINUM DOME STRAINER

MODEL NUMBER	WT. Lbs	DESCRIPTION	A.R.E. LOOSE GRATE (STANDARD)	NICKEL BRONZE FRAME AND GRATE (-1)	STAINLESS STEEL FRAME AND GRATE (-3)
FS1732,3,4	37.00	12" x 12" x 8" Deep	\$1147.00	\$1533.00	\$1533.00

FS1730 AND FS1730-FL OPTIONAL VARIATIONS:

SUFFIX	DESCRIPTION	LIST PRICE	SUFFIX	DESCRIPTION	LIST PRICE
-5	Sediment bucket (FS1700-PB)	\$164.00	-32	Deep seal trap (2", 3", 4" no hub)(MI-950 Series)	\$226.00
-6	Security screws (TR25 Torx and pin) (-1, -3 only)	\$ 39.00	-51	2 1/2" round center grate opening (-1, -3 only)	\$ 91.00
-7	Trap seal primer connection, use MI-600	\$ 99.00	-69	Stainless Steel Sediment bucket (FS1500-PB-3)	\$307.00
-9	Hinged grate (-1, -3 only) (see page 190)	\$181.00	-83	Stainless Steel mesh screen over stainless steel bucket (add to S.S. Bucket)	\$243.00
-21	Secondary flat strainer (FD-9600 Series)	\$ 31.00	-150	Half grate	No Add
-22	Less Enamel Cast Iron grate (deduct)	-\$118.00	-175	3/4 grate	No Add
-22	Less Nickel Bronze grate (deduct)	-\$252.00	-C	Membrane clamp (add to FS1730-FL only)	\$102.00
-22	Less Stainless Steel grate (deduct)	-\$252.00	P	Push on outlet (2", 3", 4")	No Add
-30	PVC socket connection W/A.R.E. Body(2", 3", 4")	No Add	T	Threaded outlet (2", 3", 4")	\$ 40.00
-31	ABS socket connection W/A.R.E. Body(2", 3", 4")	No Add	X	Inside caulk outlet (2", 3", 4")	No Add

FLOOR SINK STANDARD FUNNEL OPTIONAL VARIATIONS:

SUFFIX	DESCRIPTION	A.R.E.	NICKEL BRONZE (-1) STAINLESS STEEL (-3)	SUFFIX	DESCRIPTION	A.R.E.	NICKEL BRONZE (-1) STAINLESS STEEL (-3)
-F4	4" round funnel	\$ 91.00	\$218.00	-F6	6" round funnel	\$147.00	\$325.00
-G	4" x 9" oval funnel	\$218.00	\$454.00	-J	3" x 1" oval funnel	P.O.A.	P.O.A.

FS1730-FL SERIES 12" x 12" x 8" DEEP FLOOR SINK WITH FLANGE

FS1730-FL SERIES

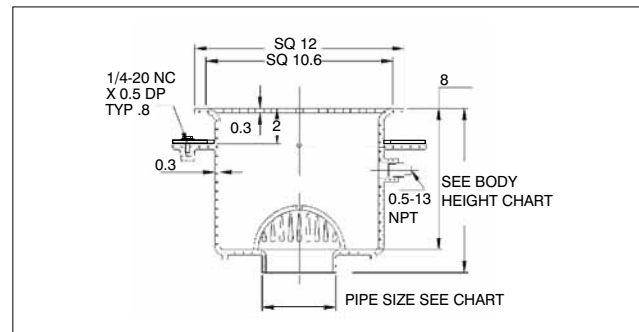
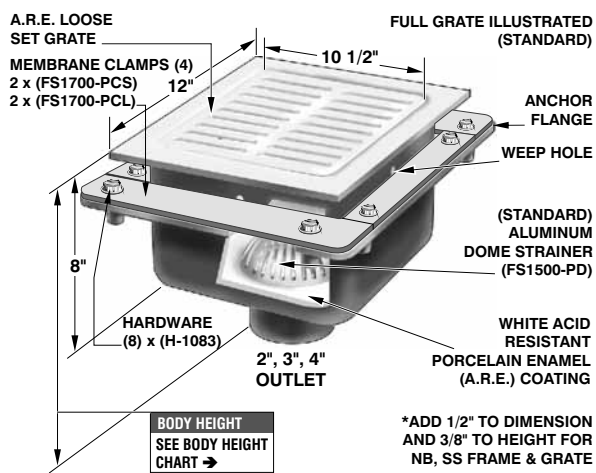

FS1730-FL SERIES BODY HEIGHT

PIPE SIZE	NO HUB STANDARD	PUSH ON (P)	INSIDE CAULK (X)	THREADED (T)	PVC (-30)	ABS (-31)
2"	10 5/8"	11 1/8"	10 5/8"	10 1/8"	11 5/8"	11 5/8"
3"	10 5/8"	11 1/8"	10 5/8"	10 1/2"	11 5/8"	11 5/8"
4"	10 5/8"	11 1/8"	10 5/8"	10 1/2"	11 5/8"	11 5/8"

A.R.E. CAST IRON BODY WITH FULL GRATE & ALUMINUM DOME STRAINER

MODEL NUMBER	WT. Lbs	DESCRIPTION	A.R.E. LOOSE GRATE (STANDARD)	NICKEL BRONZE FRAME AND GRATE (-1)	STAINLESS STEEL FRAME AND GRATE (-3)
FS1732,3,4-FL	44.00	12" x 12" x 8" deep w/flange	\$1345.00	\$1732.00	\$1732.00

Design and dimensions are subject to modification. Prices do not include applicable taxes. Visit www.mifab.com for the most recent product information.

MIFAB, Inc., 1321 West 119th Street, Chicago, Illinois 60643-5109, USA

Toll Free 1-800-465-2736, Fax 773-341-3049

All sales subject to MIFAB's Terms and Warranties. Please refer to inside front cover.