

F1210C SERIES FLOOR DRAIN FOR MEMBRANE FLOOR AREAS

F1210C SERIES

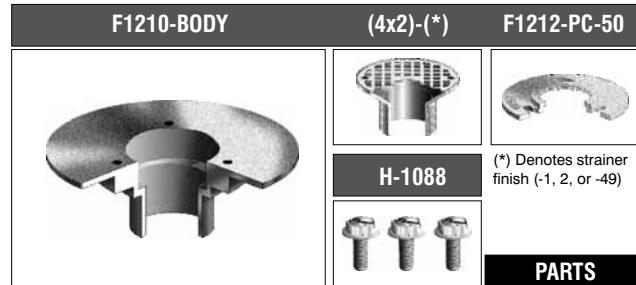
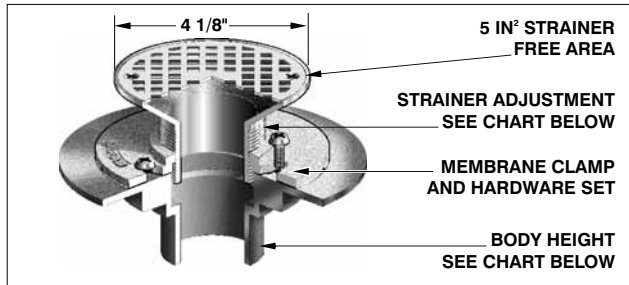

STRAINER ADJUSTMENT			ANSI/ASME RATING	BODY HEIGHT				F1210C SERIES OPTIONAL VARIATIONS			
PIPE SIZE	MIN	MAX	LOAD RATING	PIPE SIZE	NO HUB	THREADED	PUSH ON	CAULK	SUFFIX	DESCRIPTION	LIST PRICE
2", 3", 4"	1 1/4"	2 3/8"	UP TO 2000 Lbs	ALL	2 5/16"	2 5/16"	3"	3 5/16"	-15	Extension (Cast iron)	\$71.00

FLOOR DRAIN FOR MEMBRANE FLOOR AREAS							
MODEL NUMBER	WT. Lbs	STRAINER SIZE	OUTLET SIZE	LIST PRICE NICKEL BRONZE (-1)	LIST PRICE POLISHED BRONZE (-2)	LIST PRICE CHROME PLATED (-49)	BODY & MEMBRANE CLAMP & BOLTS ONLY
F1212,3,4C	3.50	4" DIA	2", 3", 4" NH	\$176.00	\$168.00	\$190.00	\$40.00
F1212PC	4.00	4" DIA	2" PUSH ON	\$176.00	\$168.00	\$190.00	\$40.00
F1212TC	3.65	4" DIA	2" I.P.S.	\$176.00	\$168.00	\$190.00	\$40.00
F1212XC	4.00	4" DIA	2" CAULK	\$176.00	\$168.00	\$190.00	\$40.00

F1220 SERIES FLOOR DRAIN FOR NON MEMBRANE & CORE DRILL FLOOR AREAS

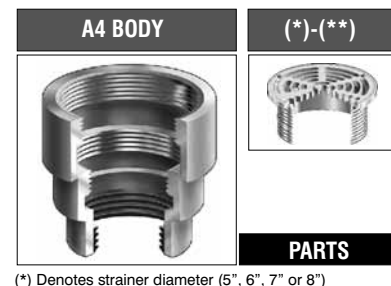
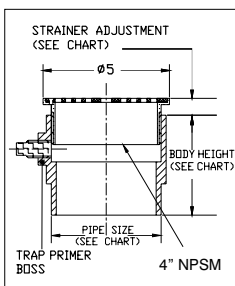
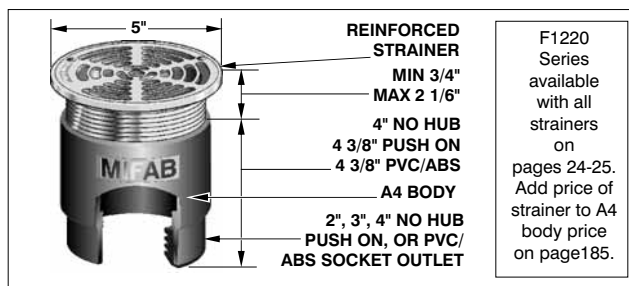

FLOOR DRAIN FOR NON MEMBRANE & CORE DRILL FLOOR AREAS					
MODEL NUMBER	WT. Lbs	OUTLET SIZE	STRAINER SIZE	NICKEL BRONZE (-1)	LIST PRICE DUCTILE IRON (-4)
F1222,3,4	5.00	2,3,4" NO HUB	5" DIA	\$249.00	\$218.00
F1222,3,4P	6.00	2,3,4" PUSH ON	5" DIA	\$249.00	\$218.00
F1222,3,4-30/31	3.00	2,3,4" PVC/ABS	5" DIA	\$249.00	\$218.00

ANSI/ASME RATING		
STRAINER	FREE AREA	LOAD RATING
5" DIA DI	8 IN ²	OVER 10,000 lbs
5" DIA NB	8 IN ²	UP TO 2000 lbs
5" DIA SS	8 IN ²	5000-7499 lbs

F1230 SERIES F1230 FLOOR DRAIN & F1230-WF WOOD DECK FLOOR DRAIN

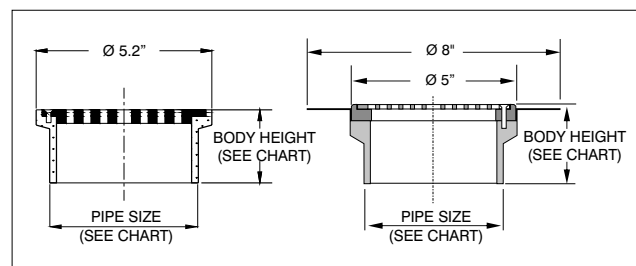
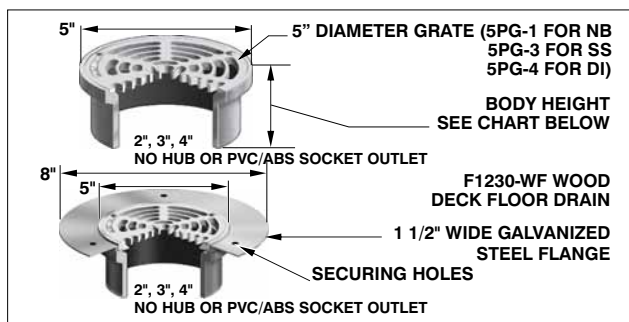

F1230 & F1230-WF FLOOR DRAIN					
MODEL NUMBER	WT. Lbs	OUTLET SIZE	STRAINER SIZE	LIST PRICE: NB BODY W/NB STAINLESS STEEL (-3)	LIST PRICE: CI BODY (-50) W/DUCTILE IRON (-4)
F1232,3,4	4.00	2", 3", 4"	5" DIA	\$160.00	\$118.00
F1232,3,4-WF	4.75	2", 3", 4"	5" DIA	\$221.00	\$178.00
MODEL NUMBER	WT. Lbs	OUTLET SIZE	STRAINER SIZE	LIST PRICE: PVC OR ABS SOCKET BODY W/NICKEL BRONZE (-1)	LIST PRICE: PVC OR ABS SOCKET BODY W/DUCTILE IRON (-4)
F1232,3,4-30-31	2.00	2", 3", 4"	5" DIA	\$160.00	\$118.00
F1232,3,4-WF-30,31	2.75	2", 3", 4"	5" DIA	\$221.00	\$178.00

F1230 BODY HEIGHT		
PIPE SIZE	CAST IRON	PVC/ABS
2" NO HUB	2 1/2"	2 15/16"
3" NO HUB	2 1/2"	2 15/16"
4" NO HUB	2 1/2"	2 15/16"

F1230, F1230-WF ANSI/ASME RATING		
STRAINER	FREE AREA	LOAD RATING
NB GRATE	8 IN ²	UP TO 2000 lbs
DI GRATE	8 IN ²	OVER 10,000 lbs
SS GRATE	8 IN ²	5000-7499 lbs

Design and dimensions are subject to modification. Prices do not include applicable taxes. Visit www.mifab.com for the most recent product information.

MIFAB, Inc., 1321 West 119th Street, Chicago, Illinois 60643-5109, USA

Toll Free 1-800-465-2736, Fax 773-341-3049

All sales subject to MIFAB's Terms and Warranties. Please refer to inside front cover.

FLOOR DRAINS

F1230 SERIES