

Steam Boilers

They've been with us for over two hundred years, and most of the time, they're so reliable most folks don't give them much thought. They sit in buildings all over the world, transferring heat from fuel to water, allowing us to warm our buildings or complete our processes.

Steam boilers are simple, efficient and reliable. No machine does a better job of moving BTUs from one place to another. We've used them for space heating since before the United States Civil War in 1861.

Even before the Civil War, we used steam boilers for industrial processes. Today we use them to run factories, press clothes, wash dishes, pasteurize milk, sterilize medical equipment, and to heat entire cities! Their capabilities seem endless.

But despite its simplicity, any steam boiler can run into trouble if its control system doesn't act properly. If the energy you put into the boiler exceeds what the boiler can absorb, the boiler can rupture. So you must always be on guard.

A simple safety relief valve of the right capacity and relief-pressure setting protects the boiler from over pressure. But over pressure isn't the only thing that can threaten a steam boiler. There are also the dangers of dry firing.

Should the internal water level drop too low, the boiler can burn out. So here too, you must always be on guard. You see, a steam boiler needs its water to move the heat away from its metal surfaces. Without the right internal level of water, heat quickly accumulates. Too much heat creates a very dangerous operating condition.

Boiler manufacturers have always set up minimum safe water level requirements for their equipment. Our controls help enforce those requirements in two ways:

- By maintaining a minimum safe water level in the boiler.
- By signaling the burner to stop should the water level drop below that point.

In this brief Systems Guide we will explain how we do these two very important jobs.

What's a "Normal" Water Level?

The proper steam boiler water level varies from manufacturer to manufacturer, but generally, we can say that it's "normal" to start by manually filling the boiler to the two-thirds-full point on the gauge glass. As the boiler operates, the water will quickly turn to steam and head out toward the system (Fig. B).

Steaming takes place at a constant rate of about one-half gpm per 240,000 BTU/HR (D.O.E. Heating Capacity

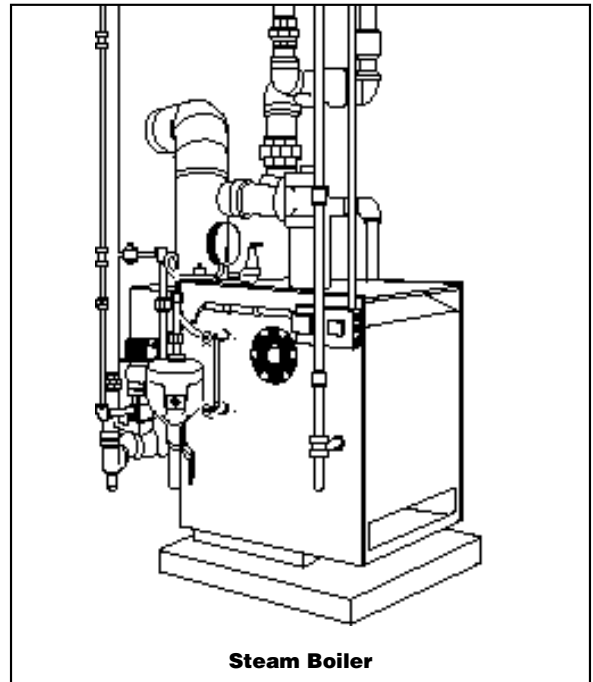

Steam Boiler

Fig. A

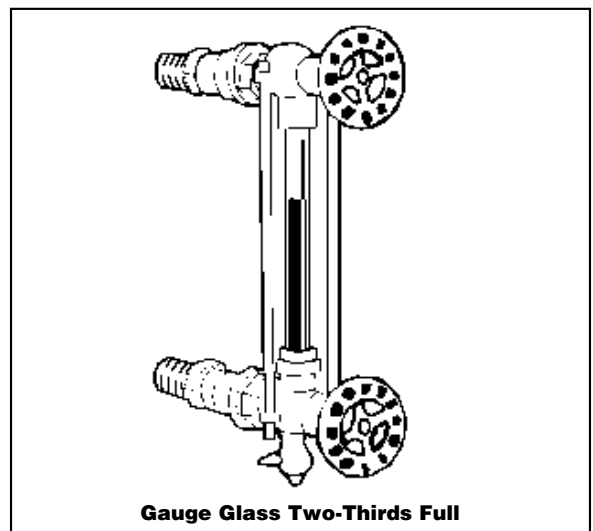

Gauge Glass Two-Thirds Full

Fig. B



Rating). This is a law of physics so it doesn't vary from manufacturer to manufacturer. If you're working with a boiler with a rating of, say, 1,000,000 BTU/HR, you can be assured the water is turning to steam and leaving that boiler at the rate of about two gpm. And it's leaving at speeds measured in miles per hour (sometimes exceeding 60 mph!). So it's very important for your near-boiler piping to be correct. If it's not, the fast moving steam will pull water out of the boiler and create problems for you in the system and the boiler.

As the water (in the form of steam) heads out toward the system, the water level in the boiler will, of course, drop. How far it drops, depends a lot on the size and condition of your piping system. You see, *ideally*, the water should begin to return to the boiler before the boiler's internal water line drops to a critical point. That's the point at which the low water cut-off will cut power to the burner, or an automatic water feeder will open.

Because the water is in the system piping and radiating during operation, the "normal" water level becomes a point that's somewhere in the lower-third of the gauge glass (Fig. C).

Remember, you're working with a *range* of operation here, not a fixed point. If the water were to stay at the top of the gauge glass all the while the burner was firing, you probably wouldn't be making steam! So don't get too caught up with the word "normal" because the only thing that's normal is that the water level will rise and fall.

Boiler manufacturers, as we said before, *do* establish a minimum safe water level for their boilers, however. That point is usually just out of sight of the bottom of the gauge glass. Should the water level drop to this point, the boiler may be in danger of overheating. We have to find a way to protect the boiler from itself (Fig. D).

All leading authorities and insurance companies recognize this need. The ASME Code for Low Pressure Heating Boilers, for instance, specifies, "*Each automatically fired steam or vapor steam boiler shall be equipped with an automatic low water fuel cut-off.*" The device the code refers to is what most people in the field commonly call a "low water cut-off." Its job is to stop the burner and protect the boiler.

What Causes a Low Water Condition?

Because it's an open system, some evaporative water loss is normal for a steam system. How much depends on the size and condition of the system. If you're losing too much water, however, it's time to begin troubleshooting. There are many places to look.

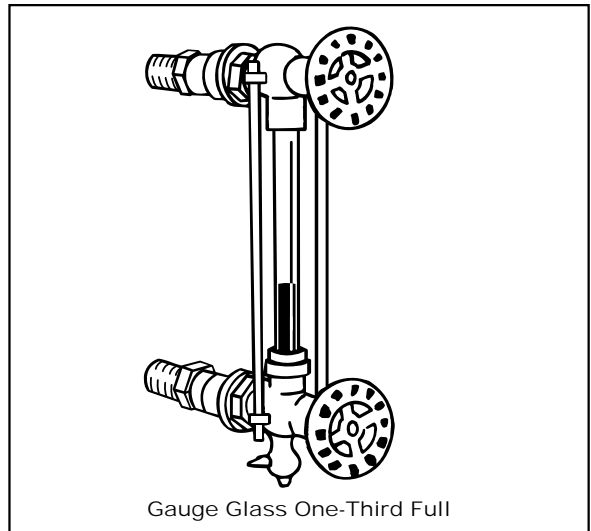

Fig. C

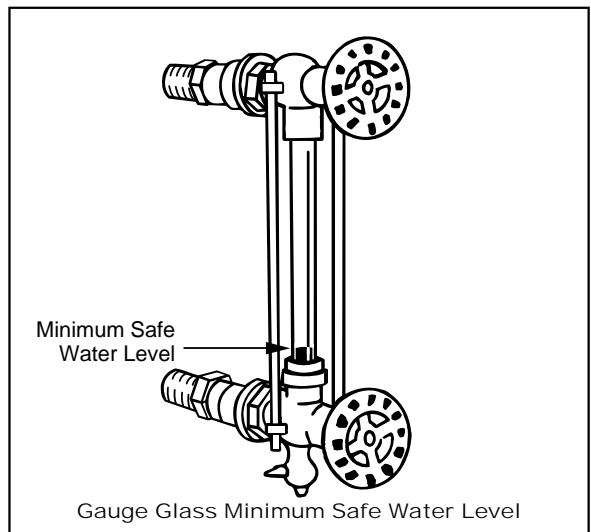

Fig. D



Here are a few good places to start:

- The air vents are dirty, not seating properly, and passing steam to the atmosphere.
- Someone left the boiler blowdown valve partially open.
- Someone, for whatever reason, has been drawing hot water from the boiler.
- The relief valve has discharged.
- The condensate pump isn't working as it should.
 - The float may have come loose.
 - The condensate may be too hot to pump.
(Check those steam traps!)
- Improper near-boiler piping may be throwing water up into the system, or causing the waterline to tilt during operation.
- The wet returns may be leaking. (Always suspect *any* buried pipe).
- A check valve may be stuck closed or partially closed.
- The boiler may be foaming and priming.
 - Check the pH of the water. It should be between 7 and 9.
 - Check the condition of the water. Dirty water will prime and foam.
 - Check the burner's firing rate. Over-firing can cause priming.
- The pipes may not be properly pitched.
- The automatic feeder may not be working properly.
 - Its chamber may be filled with sediment.
 - Its feed line may be clogged.
- All of the condensate may not be returning from the system (a common problem with process applications).
- The boiler metal may be corroded and leaking at the water line.
 - Flood the boiler to its header to check for leaks.

Good troubleshooters take the time to look over the entire system before deciding what's wrong. Take the time to do it right, and you'll be the person with the answers.

Watching the Water Level

The best way to prevent overheating damage to a boiler is to stop the burner if the water level falls too low. This is the low water cut-off's job. There are several types of low water cut-offs you can use. Let's look at them.

Float Operated Low Water Cut-Offs

Float operated low water cut-offs have been around (Fig. E) since the 1920s and have earned a reputation worldwide for reliability. Usually, you'll mount this type of low water cut-off directly in the boiler's gauge glass tapplings. We make "quick hook-up" fittings for these units to simplify installation.



Series 67 Float Type Low Water Cut-Off

Fig. E



The water level in the low water cut-off's chamber will mimic the water level in the boiler. As the water level drops in the boiler during steaming, the level in the chamber, and the cut-off's float drops with it. Should the float drop to the boiler's critical low water cut-off point, the float will trip an electrical switch that's wired in series with the burner. The burner instantly stops firing. It will stay off until the water level rises to a safe operating point.

This happens when the condensate returns from the system or when an automatic water feeder or a boiler attendant adds water to the boiler. When the level reaches a safe position, the low water cut-off will make its electrical connection and the burner will restart.

When a steam system is well balanced, the low water cut-off's job is to stand by and wait. The situation we just described suggests that there's something out of balance in that system. We'll look at this again in a few minutes.

Probe and Float Type Built-In Low Water Cut-Offs

There are some jacketed boilers that don't easily accept quick hook-up fittings. These boilers will often have a tapping for a built-in low water cut-off. These built-in units do the same thing as the external units we just looked at, but instead of being in a chamber, the "built-ins" are right inside the boiler where they can sense the water level directly.

We make two types of built-in low water cut-offs:

Probes – The boiler manufacturer will specify the point where they'd like to have this type of low water cut-off inserted. It will usually sit just below the water line, at a point above the boiler's crown. A probe uses the boiler's water to complete an electrical circuit past an insulator (the center portion of the probe) back to a ground (the threaded portion of the probe). As long as water covers the probe an electronic "go" signal will travel to the burner. When water drops off the probe for a continuous ten seconds, an electronic "stop" signal goes to the burner, shutting it down and protecting the boiler from a low water condition.

At ITT McDonnell & Miller, we manufacture several different types of probe low water cut-offs to meet any of your job applications (Fig. F).

One of those applications might involve the boiler's water level. The water capacity of today's boilers is considerably less than that of boilers from decades ago. Along with this, the water level operating range of today's boilers is smaller. Further, the amplitude of surging water levels is increasing. As a result, the low water cut-off must be "smart" enough to recognize these variations and react appropriately. We have done this by



Series PS-800 Probe Type Low Water Cut-Off

Fig. F



incorporating delay features in the probe's operating logic. These include a delay on break feature (DOB) which keeps the burner lit for 10 seconds after water leaves the probe. This minimizes the effects of a surging water line. Another addition – the delay on make feature (DOM) – allows an additional feed time of 15 seconds once water comes in contact with the probe. This minimizes rapid burner and feeder cycling by slightly elevating the water level so that water lost to steaming will return (in the form of condensate) before the water level drops below the probe.

Float Type – In operation, these are similar to the external, float operated low water cut-offs we looked at before. The difference is that instead of sensing a duplicated water level *outside* the boiler, these units sense the level directly inside the boiler.

We make them for you in five mounting-barrel sizes (Series 69) to accommodate different boiler insulation thicknesses. When you select a built-in, float type control make sure it fits as far as possible into the boiler, without the float shield coming contact with the boiler.

When a low water cut-off stops a burner, it also stops the entire heating system. Nothing will happen until the water in the boiler returns to a safe operating level.

While this is very good for the boiler, it may not be the best thing for the system. If the heat in the building is off for too long a time, water pipes may begin to freeze.

This is where automatic water feeders come in. An automatic feeder will maintain a safe minimum water level in the boiler and keep it operating, even if the system is leaking. It keeps the system operating automatically until you can make the repairs.

Combination Low Water Cut-Offs and Automatic Water Feeders

Two of our most popular and versatile feeders are the Uni-Match® and the 101A (Fig. G and H). These are ideal for use in residential or small commercial applications. They are versatile in that they are compact and they are easily installed to operate with either a probe type OR a float type low water cut-off. These feeders are always ready to add water when given the signal from the low water cut-off. The benefits they offer are the convenience of not having to manually add water – and most importantly – they will protect the boiler from a dry fire condition by maintaining a safe minimum water level in the boiler should a system leak occur.

If you use a mechanical automatic water feeder, you can keep your burner operating even during a power failure.



Uni-Match® Water Feeder

Fig. G



Series 101-A Water Feeder

Fig. H



A mechanical feeder can also protect a boiler (Fig. I) should a fuel-regulating device malfunction, causing the burner to lock in and stay there. Or suppose someone jumps-out a control, putting the burner on continuous operation. A mechanical automatic water feeder will continue to feed the boiler whenever the level drops to the “feed” point.

Under normal circumstances, the electrical low water cut-off (the second part of the feeder/cut-off combination) is always standing by, ready to shut off the burner should something go wrong with the automatic feeder.

An automatic water feeder doesn’t feed at the two-thirds full point on the gauge glass. You set this by hand when you first start the system. As we said before, the “normal” level will range up and down as the system operates. An automatic feeder will maintain a safe *minimum* water line only. By doing this, it will lessen the possibility of human error.

Consider this. A boiler attendant might put too much water in a steam boiler. He doesn’t have an automatic feeder and he’s tired of checking the water level every day so he fills the boiler to the two-thirds full point while it’s operating. When the condensate returns, the boiler floods. By adding water the attendant has limited the boiler’s steam-making space. Without enough room to break free of the water, the steam will now carry water up into the system piping. This leads to higher fuel bills, uneven heating, water hammer, scale formation in the boiler and burner short-cycling. Suddenly, problems plague this system, and no one is sure why.

Automatic water feeders help you avoid these problems. They watch that water level, maintaining a safe *minimum*. They allow the boiler water line to rise and fall naturally through its normal operating range.

How a Feeder/Cut-Off Combination Works

During Normal Operation – This is how a McDonnell & Miller feeder/cut-off combination looks on a steam boiler (Fig. J). Notice how we have it installed well below the boiler’s “normal” start-up operating range (that’s about two-thirds up the gauge glass). We don’t want it to feed while the water is out in the system as steam.

Remember, the automatic water feeder is there to maintain a safe minimum water line, not a “normal,” start-up water line.

As you now see it in the drawing, the feeder is closed and the burner is firing. The boiler is working, sending steam out to the building, and both the automatic water feeder and low water cut-off are standing by.

The Feeder Opens – If the boiler’s water line drops to the feeder/cut-off combination’s feeder-operating point (which is very near the bottom of the gauge glass) (Fig. K), the feed valve will open mechanically and add water to the



Fig. I

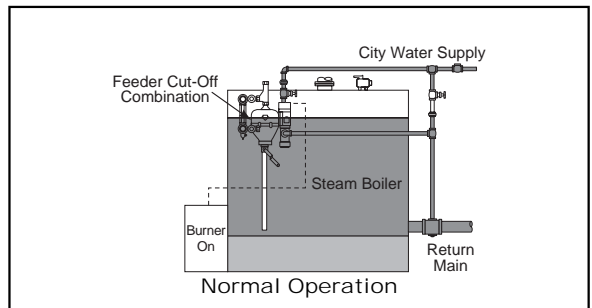

Fig. J

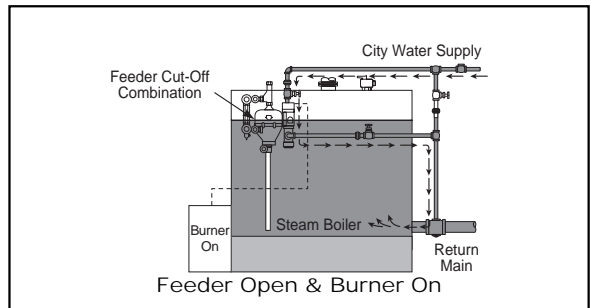

Fig. K



boiler. How much water will enter the boiler depends on several things, but there will always be enough to keep the boiler operating at a safe *minimum* water level. Once it has added the right amount of water, the feeder closes. While this is happening, the burner continues to run because the feeder keeps the boiler from dropping to its low water cut-off point.

The Low Water Cut-Off Stops the Burner – But suppose something happens and the automatic water feeder can't keep up with the rate at which the boiler is losing water. Suppose, for instance, that a pipe breaks or someone opens a boiler drain, causing the boiler to suddenly lose water. Should this happen, the water level will drop to a preset point, and the automatic feeder/cut-off combination will instantly cut power to the burner, shutting it down and protecting the boiler from a dry-firing condition. Though the burner is off, the automatic feeder will continue to add water to the boiler in an attempt to restore a safe minimum water level (Fig. L).

As you can see, a combination *mechanical* water feeder and *electrical* low water cut-off provides you with boiler protection even if the power fails or something goes wrong in the burner circuitry.

Combination Water Feeders and Low Water Cut-Offs for Larger Boilers

As we said earlier, all steam boilers evaporate water at the rate of one-half gpm per 1,000 square feet EDR (240,000 BTU/HR). To satisfy a larger boiler's needs, an automatic water feeder must be able to match the boiler's higher steaming rate. If the feeder can't keep up, the burner will suffer from nuisance low water shutdowns. To avoid this problem, we make automatic feeder/cut-off combinations with wider flow orifices to meet the special needs of larger boilers. The operation of these larger units is the same as the ones we just looked at. The key difference is the increased flow rate (Fig. M).

Once the larger feeder/cut-off combination satisfies the boiler's minimum water line needs, it has to be able to close against the force of the city water pressure moving through that extra wide orifice. This calls for considerable float and lever power, and it explains why our feeder/cut-off combinations for larger boilers are bigger than those for smaller boilers. We've carefully engineered them to get the maximum closing force in the space we have to work with. This ensures the unit will close tightly once it's done its job (Fig. N).

Codes call for larger boilers to have their gauge glasses mounted on water columns, rather than directly into the boiler. Consequently, we make our larger automatic

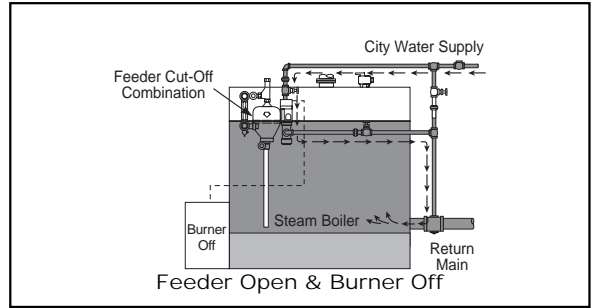

Fig. L

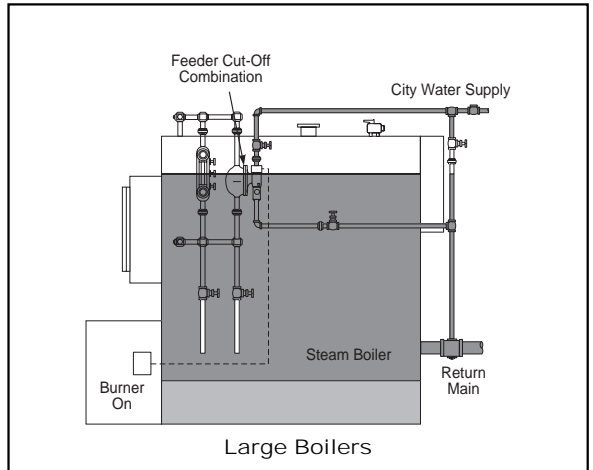

Fig. M



Series 51-2 Mechanical Water Feeder

Fig. N



water feeders and feeder/cut-off combinations without “quick hook-up” fittings. Instead, we give these larger combinations one-inch (25mm), float chamber tappings so you can mount them directly on an equalizing line.

Watching the Water Level in Process/Space-Heating Boilers

Now let’s suppose you’re installing a steam boiler in a factory. Some of the total steam load will travel to unit heaters where it will keep the workers warm. The rest of the steam will go to a steam table in the cafeteria, a dishwasher, an oil preheater on the boiler, a few sterilizing cabinets on the plant floor, and a half dozen other process applications.

This job offers a special challenge because a good portion of the condensate won’t be working its way back to the boiler. Some of this condensate is tainted in the process and we need to handle it specially. Because of this, you’re going to have to consistently add feed water to keep this process/space heating boiler operating.

If you use a combination feeder/cut-off on this job you may run into a problem because the vertical space on the control between its “feed” point and its “cut-off” point is relatively small. The feeder might not be able to keep up with the system’s process needs, and if it can’t, the boiler might drop into a low water condition and shutdown.

It’s best to install a *separate* automatic feeder and low water cut-off on a job such as this when you know some condensate won’t be returning (Fig. O). Set up this way, the feeder can open fully and deliver its maximum capacity to the boiler before the low water cut-off (installed at a lower level) goes into action. By piping the system like this, you eliminate nuisance burner cut-offs while meeting both your heating and process needs.

When you select the water feeder and low water cut-off for your process/space heating application, always check to make sure the operating pressure of your system doesn’t exceed the maximum operating pressure of either control.

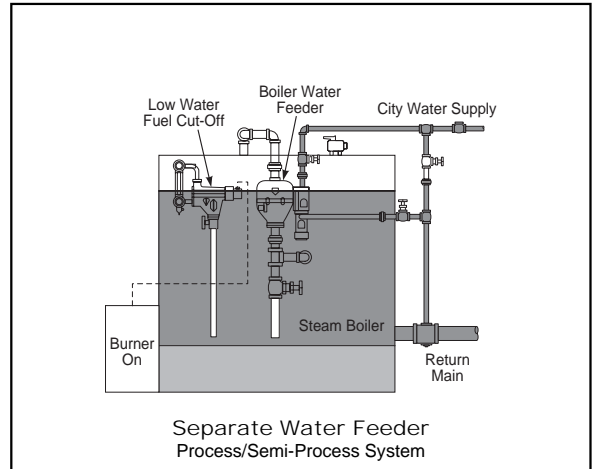

Fig. O

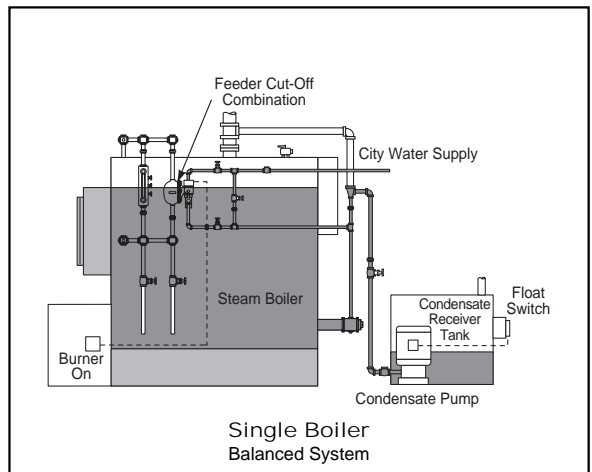

Fig. P

The Importance of System Balance

Steam Systems With Condensate Pumps

Most two-pipe steam systems, and some one-pipe steam systems, need help returning condensate to the boiler (Fig. P). The pump’s job is to provide the “push” the water needs to get back into the boiler. The water leaves the boiler as steam, condenses into a liquid in the radiators and piping, and flows by gravity into a



condensate receiver. When the water level inside the receiver reaches a certain point, an electrical float switch turns the pump on. The pump quickly moves the water out of the receiver and back into the boiler.

Steam boilers served by condensate pumps also need low water protection, and our low water cut-offs serve that purpose well. You can also use an automatic water feeder or a combination feeder/cut-off on these systems. But before you do, make sure the system is well balanced. What we mean by "well balanced" is that the condensate pump should be able to return the water to the boiler before the boiler's water level drops to a point where the low water cut-off or automatic feeder goes into action.

If the automatic water feeder adds water to the boiler (to maintain a safe minimum operating level), and then the condensate pump returns its water to the boiler, the boiler will most likely wind up with too much water. This excess water limits the boiler's steam making space. Without enough room to break free of the water, the steam can carry water up into the system piping. That leads to higher fuel bills, uneven heating, water hammer, scale formation in the boiler and burner short cycling.

So before you use an automatic water feeder on a steam boiler that's served by a condensate pump, check to see if the system is well balanced. It should run through its cycles without going off on low water. In other words, the condensate pump should balance the flow of water back into the boiler before the level drops to the critical, low water point. Keep in mind that a system with a condensate pump can become unbalanced if the returns clog with sediment or if any steam traps fail in an open position.

Good troubleshooters always keep their eyes wide open.

If you have a system where some steam is going for process (meaning, it won't be coming back), or if your system isn't well balanced, you should consider using a boiler feed pump instead of a condensate pump.

A boiler feed pump serves the same purpose as a condensate pump (Fig. Q). It provides the "push" the water needs to get back into the boiler. The difference between a condensate pump and a boiler feed pump, however, lies in the way we control the two units. Instead of having an electrical float switch inside the condensate receiver, a boiler feed pump takes its orders from a McDonnell & Miller pump controller mounted directly on the boiler.

The pump controller has two switches. The first switch (set at the higher of the two levels) operates the boiler feed pump. When the boiler needs water, the pump

controller recognizes the need and starts the pump. When the boiler water returns to the proper level in the gauge glass, the pump controller stops the pump. Should the pump not be able to keep up with the boiler's need for water, the pump controller will sense this as well. The second switch (set at the lower of the two levels) will cut the electricity to the burner and protect the boiler from a low water condition (Fig. R).

Feed water enters the system through a make-up water feeder in the boiler feed pump's receiver. If you wish, you can add a feeder/cut-off combination to operate at a level a bit lower than the pump controller. This will give you a mechanically operated feeder, which will act as a back-up should something go wrong with the pump controller. It will also give you a secondary low water cut-off. It's like having a belt and suspenders for your boiler!

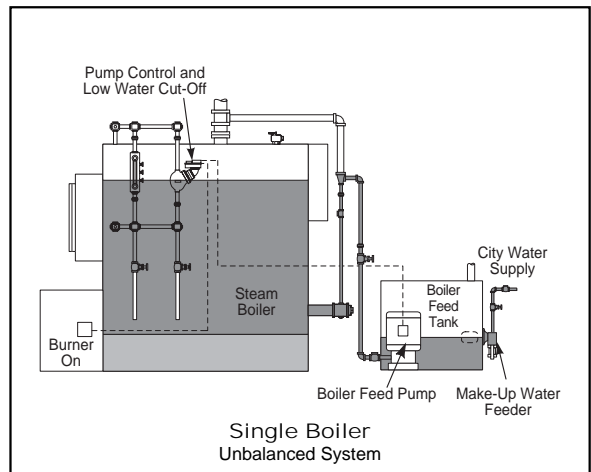

Fig. Q

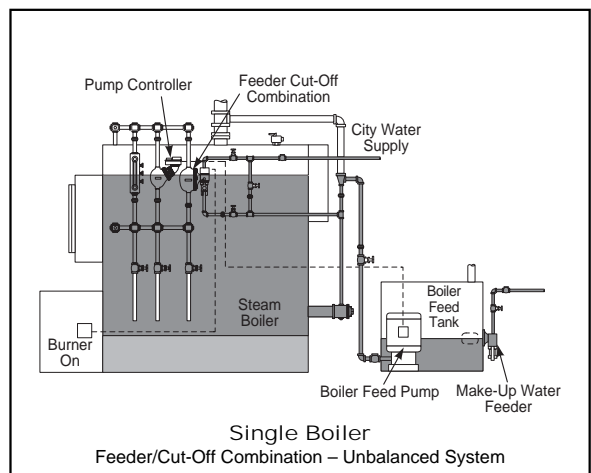

Fig. R



Meeting the Needs of Systems with Multiple Steam Boilers

(Fig. S, T U)

The boiler on the right may be a stand-by to the boiler on the left. Every week or so, a boiler attendant might switch them, making this one the operating boiler and the other the stand by.

It's a good idea, one we've used for years in larger boiler rooms. By having more than one boiler, each is able to supply the entire needs of the system. Your chances of getting caught without steam are much less.

Some systems have multiple steam boilers. The idea here is to let several boilers join forces to meet the total needs of the system. The goal is energy conservation. You steam all the boilers on start-up, and then shut a few down after you've heated the system and satisfied the piping pick-up load. In other words, you put the system on "simmer" after you've heated it completely.

Steam systems with more than one boiler often have problems if the installer fails to realize that steam is dynamic and not static. By this, we mean that steam is always moving *very* quickly from the boiler to the system, and as it moves, it loses pressure. And since one ounce of pressure represents a water column 1¾ in. (45mm) high, the slightest difference in pressure between any two boilers interconnected on their return sides can make a big difference in the individual water levels.

A slight burr in a pipe or fitting can create a drop in pressure. You can never tune two burners to produce the same flame. One boiler will always be closer to the system take-off than another. These things speak loudly for proper piping and thoughtful management of the boiler water line so that's what we'll look at next.

Multiple Boiler Systems with a Boiler Feed Pump and Motorized Return Valves

Here we have two boilers served by a single boiler feed pump (Fig. S). One boiler may be a stand by to the other, or they may be sharing the total load. For piping purposes, we'd handle either application the same way.

Notice how the condensate returns are independent. Each flows from the boiler feed pump receiver to the boiler through a motorized valve. This is an important detail. If you were to interconnect the returns, the water from one boiler would flow into the other.

Steam Moves – Remember, steam is dynamic, not static. Water doesn't "seek its own" level when the steam is moving out of the boiler. The slightest difference in firing rate or piping pressure drop between the two boilers will cause one to flood and the other to shut down due to a low water condition. This is why those independent returns are important. We're using motorized valves on this installation (Fig. S) to isolate one boiler from the other. When either boiler needs water, the McDonnell & Miller pump controller on that boiler will drop to a point where it will close the higher of its two switches. That switch will power that boiler's motorized valve, causing it to open. When it's fully opened, the motorized valve will trip an end switch and start the boiler feed pump. Water will flow only to the boiler that needs it. The float in the pump controller will sense the rising water. When the water reaches the proper level, the pump controller will break the electrical connection to the motorized valve. The valve will begin to close, shutting off the boiler feed pump as it does.

As you can see, when we pipe multiple boilers this way it doesn't matter how big or small each is. The boiler feed pump, although sized for the *total* needs of all the boilers, will satisfy the needs of each in turn, no matter what size.

Keeping the Water Flowing – We've installed a make-up water feeder in the boiler feed pump's receiver tank. It's job is to maintain a minimum water line in the tank so the pump will always have a reservoir from which it can draw feed water. In this system, all the water will enter the boilers through the boiler feed pump. If, for any reason, the boiler feed pump can't keep up with the boiler's rate of evaporation, the water line in the boiler will drop. The lower switch in the McDonnell & Miller pump controller will stop the burner.

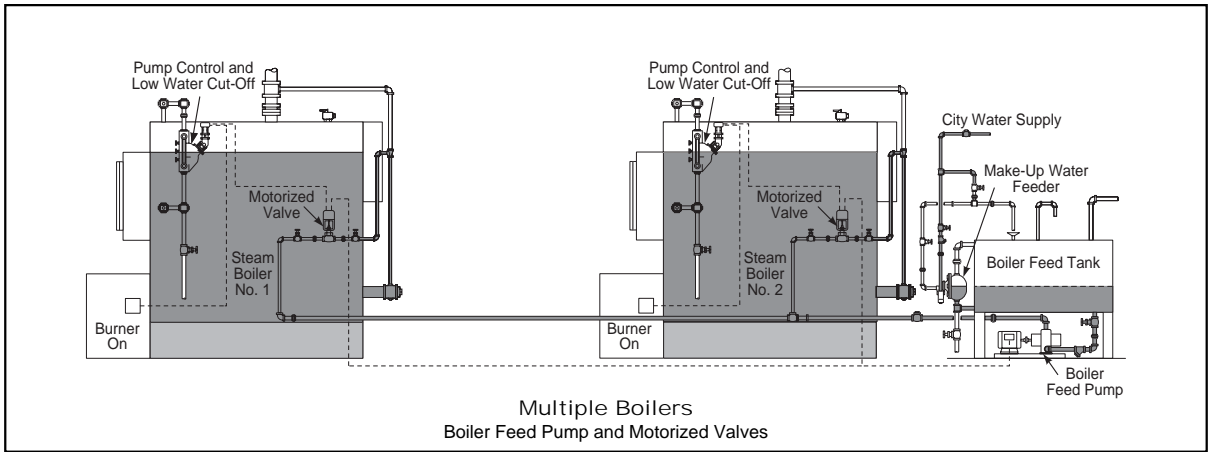

Fig. S

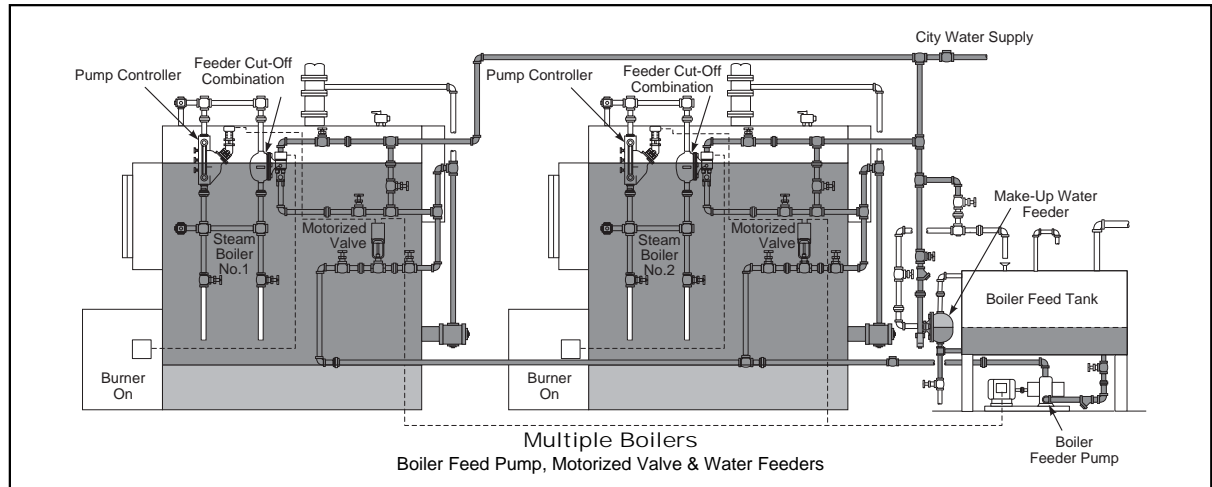

Fig. T

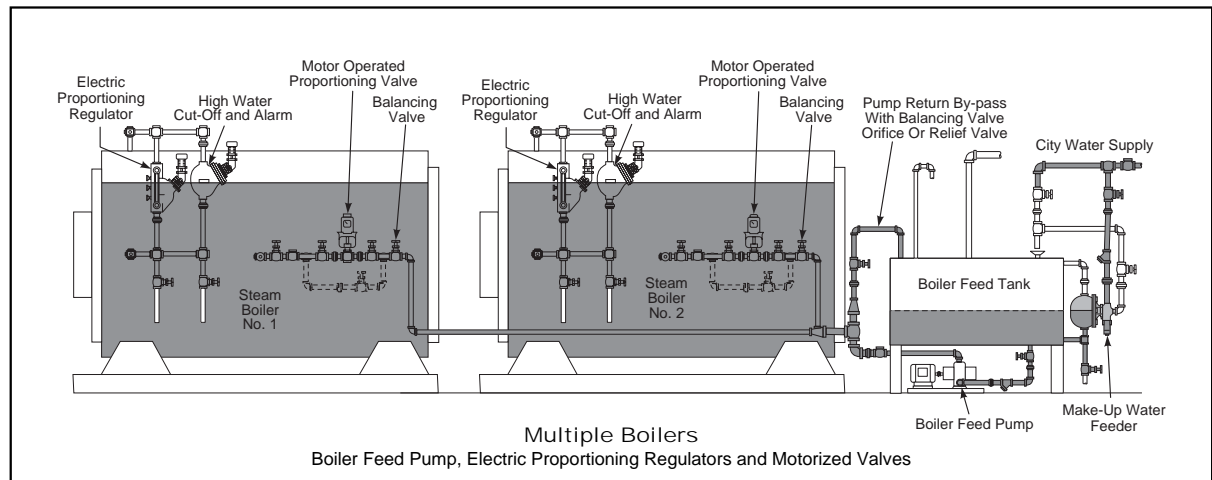

Fig. U



If you find the pump suddenly can't keep up with the boiler's needs, check the temperature of the returning condensate. As thermostatic radiator steam traps and end of main F&T traps age and fail, they pass steam into the returns. That can make the condensate hot enough to "flash" when it hits the pump's impeller. Boiler feed pumps can't move water once it has flashed to steam. The pump will turn and cavitate, but it won't satisfy the boiler.

Ideally, in a low pressure steam heating system, the condensate in the pump's receiver shouldn't be hotter than 180°F (82°C).

Multiple Boiler Systems with a Boiler Feed Pump, Motorized Return Valves and Boiler Water Feeders (Fig. T)

This is the same system we just looked at, except we've added a combination automatic water feeder and low water cut-off to a point just below the pump controller. The feeder/cut-off's job will be to add water mechanically to the boiler should something happen to the boiler feed pump (for instance, if it's cavitating because the return condensate is too hot).

Think of the feeder/cut-off as a back-up device to keep the boiler in operation should something go wrong elsewhere. The low water cut-off will back up the pump controller's primary low water cut-off should something go wrong there, or if the feeder can't keep up with the boiler's rate of evaporation for some reason.

Multiple Boiler Systems with a Boiler Feed Pump, Motorized Return Valves and Electric Proportioning Regulator (Fig. U)

Here we're controlling the water lines with electric proportioning regulators. We're matching the incoming feed water to the exact amount of water that's leaving as steam. By doing this, we're able to maintain a precise water line in both boilers and take advantage of each boiler's full steaming space.

There are times when steaming loads will vary tremendously. This is especially true of steam heating systems in larger buildings. We often set up these buildings to operate on outdoor air temperature sensors and night set-back devices. When the system first starts in the morning the boilers will steam longer than they will during the day when the pipes and radiators are hot. This is also true of seasonal operation when you run the heating system less often.

This is when proportioning regulators can make a big difference. By closely monitoring the water line, regardless of varying system conditions, you improve the quality of steam leaving the boiler and allow the system to operate more efficiently.



Receiver Tank Control

If you size a boiler feed pump's receiver properly it will be able to hold the right amount of water to keep the boiler operating during the start-up cycles. It will also be able to receive the returning condensate without overflowing.

Receiver sizing is more an art than a science. You have to look closely at the entire system to figure out how long it will take the condensate to return from the building. There are many variables to consider: The type and condition of steam traps, the pitch and cleanliness of steam mains and returns, the pipe insulation or lack of it, the shape of the building and how people use it.

There are also the times when you'll have to deal with condensate transfer pumps, or maybe a vacuum/condensate pump. These pumps collect and relay return water back to the boiler feed pump. There are many things that can affect how quickly these secondary pumps move condensate back to the primary boiler feed pump. You have to consider them all when you're sizing a feed pump receiver.

One thing will be a constant, however. There must always be enough water in the receiver for the boiler to draw from during the start-up cycle (the time between initial steaming and the return of condensate from the building). A McDonnell & Miller make-up feeder, set at the one-third full point on the receiver tank, will meet the boiler's needs during this crucial start-up time. Let's take a closer look at these.

Receiver Tank Make-Up Water Feeders

Here, we've mounted a McDonnell & Miller make-up water feeder on a one-inch NPT equalizing line that extends from the top of the tank to the bottom. The level in the feeder's chamber will be the same as the level in the tank. As the pump moves water out of the tank and into the boiler, the float inside the feeder's chamber will open and constantly replenish the tank's reservoir.

We've designed our feeders with the right amount of float and lever power to close tightly against city water pressure. This ensures that there will always be enough tank space to receive the returning condensate without having it overflow.

If the tank you're using doesn't have tapplings for an equalizing line, you can use our internal feeder (Fig. V). As you can see, it mounts directly inside the tank and feeds water through its integral strainer. We make this unit with two flange sizes for both new and retrofit installations.

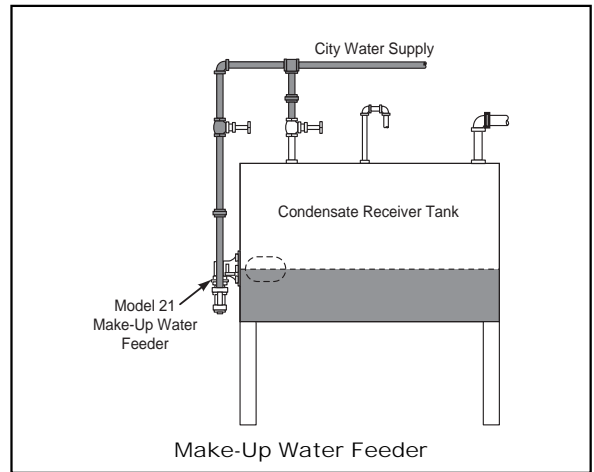

Fig. V



A Make-Up Water Feeder Used as a Pilot Valve (Fig. W)

When you have multiple boilers, the boiler feed pump has to be able to meet the needs of *all* the boilers should they need water simultaneously. During the start-up cycle, the draw from the feed pump's receiver can be very heavy and the make-up feeder has to be able to match that flow.

When we run into this situation, we often use a make-up water feeder as a pilot valve to operate a high capacity diaphragm valve with "dead-end" service. When the feeder opens it signals the diaphragm valve to snap into action. The larger valve quickly maintains the receiver at the one-third full point. Once the feed pump shuts off the dead-end service valve closes tightly to prevent over filling. If returned condensate fills the receiver, the feed valve, of course, stays closed. This piping arrangement also gives you a lot of freedom because you can put the diaphragm valve in a remote location, if you'd like, for easier service.

A Make-Up Water Feeder with a Motorized Valve (Fig. X)

Here's another way you can quickly fill the receiver. Use a McDonnell & Miller controller to sense the tank's water line. As the level rises and falls, the controller will electrically operate a high capacity motorized valve. This is another piping arrangement that gives you a lot of freedom. You can place that motorized valve anywhere you'd like.

Low Water Cut-Offs for Receiver Tanks (Fig. Y)

There's always the possibility for human error on any job. For instance, suppose someone decides to turn off the water supply to your receiver tank. The pump controller on the boiler will still start the pump, but once the receiver goes dry there won't be any water to pump because of the closed valve. Or suppose the building loses water pressure and the feed pump suddenly finds itself moving more water than the water feeder can replace. If the pump runs dry, it will cavitate and its mechanical seal will quickly heat and break. That leaves you with a costly repair and system down time.

If you install a low water cut-off in an equalizing line around the tank, the cut-off will protect the pump no matter what happens.

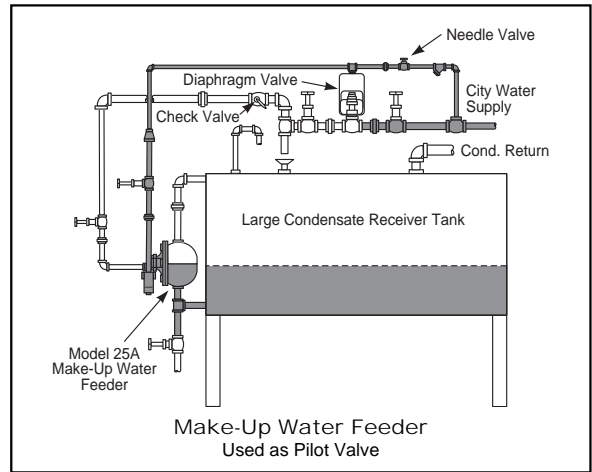

Fig. W

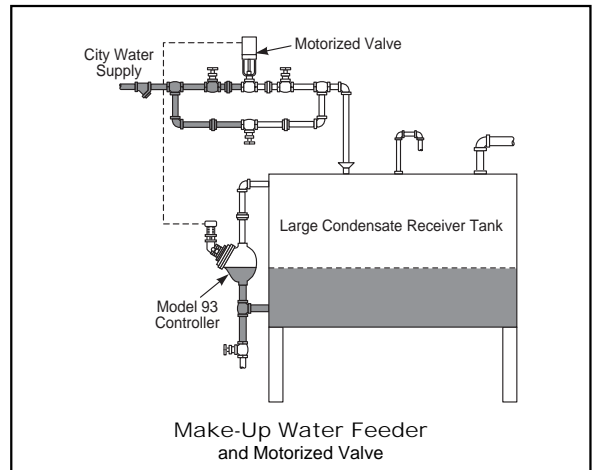

Fig. X

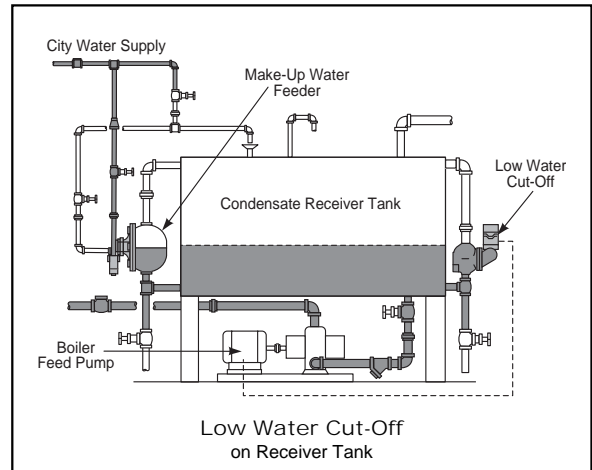

Fig. Y



Hot Water Boilers

Low water protection isn't just for steam boilers. Hot water boilers face the same perils of overheating damage if the water line drops too low. Many people don't think of this as often as they should because hot water boilers serve "closed" systems. They have pressure reducing valves that are supposed to feed water automatically should a leak develop.

The truth, however, is that a pressure reducing valve is no substitute for a low water cut-off. Pressure reducing, or "feed" valves, often clog with sediment and wind up not feeding at all. A buried pipe can corrode and spring a leak that flows faster than a "feed" valve can satisfy. Relief valves can pop and, while dumping water at a great rate, actually prevent the feed valve from operating.

Let's take a closer look at how we can protect these boilers.

Hot Water Systems (Fig. Z)

As we said, the things that affect steam boilers also affect hot water boilers. If you run them with too much water the relief valve will open. If you run them with too little water they'll overheat and suffer damage.

A low water cut-off is the only sure way of protecting a hot water boiler from sudden loss of water. The ASME boiler code recognizes this by requiring all hot water boilers of 400,000 BTU/HR or more input to have low water fuel cut-off devices.

ASME doesn't call for low water cut-offs on smaller, residential boilers, but we think *all* hot water boilers, regardless of their size, must have protection. However, the International Mechanical Code requires low water cut-offs on **ALL** hot water and steam boilers. ITT McDonnell & Miller makes several devices, both float and probe type, that protect and meet the needs of any boiler whether it's cast iron, steel, or copper construction (Fig. AA, BB, CC).

Hot water systems regularly lose water through faulty air vents, loose valve stem packing, cracked boiler sections, loose nipples, corroded pipes, broken or loose pump seals, leaking gaskets, dripping relief valves, to name just a few places. Most installers depend on their pressure reducing or feed valve, to replace the lost water automatically. But feed valves often clog with sediment, especially in hard water areas. And it's very easy to close the supply valve to a feed valve and forget to open it again.

On systems with buried pipes (say, a radiant heating system) a feed valve will open if a pipe breaks. It will feed fresh water continuously until it either clogs (and stops feeding) or destroys the ferrous components of the system with oxygen corrosion. A simple feed valve can wind up costing a lot more than its purchase price. This is why major suppliers of feed valves, such as ITT Bell & Gossett, recommend you close the feed valve once you've established your initial fill pressure.

This is also why we strongly recommend you use a low water cut-off on every hot water boiler. Feed valves are not a substitute for low water cut-offs. They can't protect your boilers from a low water condition. Feed valves are fine for filling the system initially, and for helping you vent air from the radiators. But once the system is up and running, you shouldn't look to them for protection.

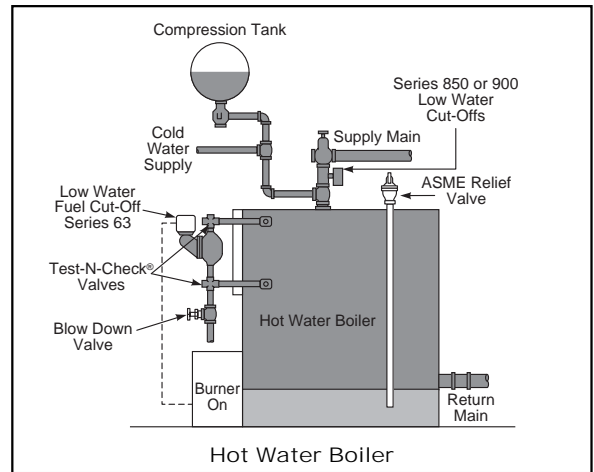

Fig. Z



Over firing

There are times when hot water boilers don't lock-out on safety. Whether by control failure or human error, things go wrong. And when they go wrong in a hot water heating system, the water temperature can rise quickly to a point where the compression tank can't take up the expansion of the water. This causes the relief valve to discharge.

When the relief valve opens, there's a sudden drop in system pressure. The water, which at this point is probably much hotter than 212°F (100°C), will flash into steam. This is why ASME insists that relief valves for hot water boilers carry steam-discharge ratings.

If a feed valve doesn't open to replace this rapidly exiting water, a low water condition will quickly result. The only thing that can protect the boiler at this point is a low water cut-off. The feed valve can't protect the boiler because its typical setting is 12 psig (.83 bar). In other words, the system pressure must drop below 12 psig (.83 bar) before the feed valve will open.

The trouble is that while the relief valve is open and flashing steam to atmosphere, the internal system pressure never drops anywhere near 12 psig (.83 bar). A relief valve with a 30 psig (2.1 bar) setting, for instance, will open at 30 psig (2.1 bar), and close again when the pressure drops to about 26 psig (1.79 bar). The result is a loss of water with no make-up. Repeat this cycle enough times and the boiler will be in a dangerous, low water condition. Keep in mind, steam exerts pressure. It can easily fool a feed valve, and that's why feed valves offer very little protection at all against low water.



Series 67 Float Type Low Water Cut-Off

Fig. AA



Series PS-851 Probe Type Low Water Cut-Off

Fig. BB



Series RB-24 Probe Type Low Water Cut-Off



Fig. CC



Feeder/Cut-Off Combinations for Cast Iron and Steel Hot Water Boilers (Fig. DD)

To protect a boiler from dry firing, the low water cut-off must be located above the boiler's crown. After the low water cut-off shuts off the burner, you should have a way to add water to the system to ensure the crown stays under water.

A combination water feeder and low water cut-off can do this for you. If you position the feeder above the boiler's crown, it will mechanically feed water if the level should drop to that point. This is an important consideration because, even if the electricity is cut off, it's possible for the firing cycle to continue if the fuel feed valve is mechanically locked open. The combination unit's cut-off switch will act as a back-up to the primary low water cut-off, providing the boiler with additional protection.

Protecting Copper Fin Tube Boilers (Fig. EE)

Copper fin tube boilers move heat from the flame to the water almost instantly. This type of boiler depends on the proper flow of water across its heat exchanger to move the heat quickly out of the boiler and into the system. Should flow stop while the burner is operating, heat will quickly build and cause the water in the heat exchanger to flash into steam. This condition is similar to a dry firing in a cast iron or steel boiler.

A McDonnell & Miller flow switch, installed on the copper fin tube boiler's hot water outlet, protects it from this danger (Fig. FF). The burner cannot fire unless water is moving across the flow switch. When the flow stops, for whatever reason, the McDonnell & Miller flow switch immediately cuts electrical power to the burner and protects the boiler from overheating.

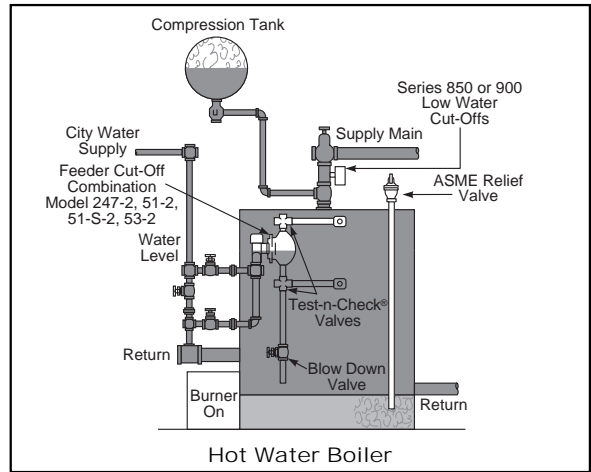

Fig. DD

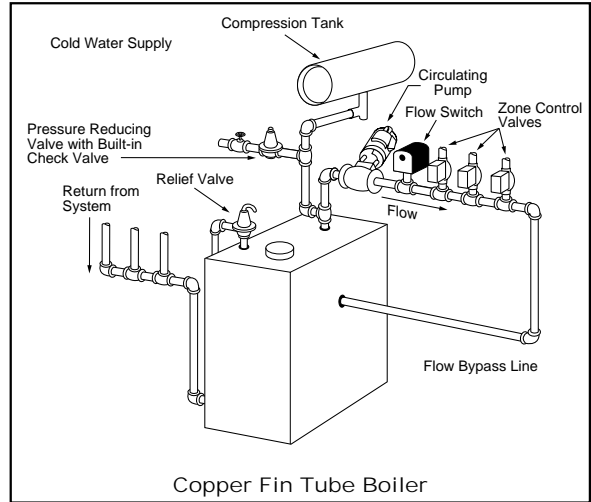

Fig. EE



Fig. FF



Pressure Relief Valves

(Fig. GG, HH)

Good engineering practice calls for every hot water boiler to have a pressure relief valve. This spring-loaded valve must be able to release the boiler's entire load at the boiler's maximum operating pressure.

Here are some things that can cause a relief valve to open in a hot water heating system:

- The automatic feed valve fails, allowing higher than normal pressure to enter the system.
- Someone leaves a hand bypass line open after filling the system.
- Someone hydrostatically tests the system at a pressure greater than the relief valve's setting.
- The air cushion in the diaphragm type compression tank doesn't match the system's static fill pressure. Keep in mind, most tanks come from the factory precharged at 12 psig (.83 bar). If the system needs more than 12 psig (.83 bar) pressure, you have to add more air to the tank, and you have to do this while you have the tank disconnected from the system.
- The compression tank may be too small for the system.
- The boiler's aquastat is in a well without heat transfer grease. When this happens, the boiler's temperature will quickly exceed the aquastat's setting, causing rapid rise in system pressure.
- The circulator may be on the return side of the system with the compression tank at its suction. If it is, the circulator's head pressure will appear inside the boiler as a net increase. It may be enough to open the relief valve.
- The burner limit may be jumped-out or stuck in a manual position.

The main thing to keep in mind when you're troubleshooting this one is that relief valves pop when any of these three things happen:

- The compression tank loses its air cushion
- The system takes on more water.
- The system temperature increases.

Think methodically, and keep your eyes wide open!

We hope this Basic System Operation Guide has given you insight into the systems on which you're now working or will face in the future. We welcome any questions or comments you may have about the Guide, or about our products.

Thanks for your support, and for your continuing business.

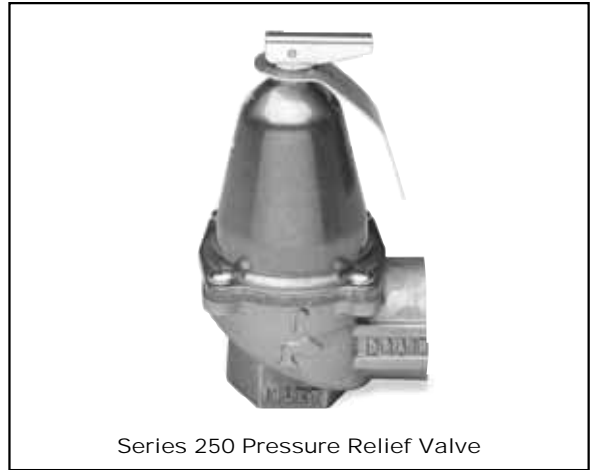

Series 250 Pressure Relief Valve

Fig. GG



Series 260 Pressure Relief Valve

Fig. HH



Hot Water Boilers

McDonnell & Miller Low Water cut-offs are specially designed to protect hot water boilers from the hazards of a low water condition. In operation they will interrupt the electrical current to the firing device, if the water in the system drops below the boiler manufacturer's minimum safe water level.

Our low water cut-offs also provide an additional circuit for a low water alarm, should you desire to install one, for additional protection.

How to Select Low Water Cut-Offs for Hot Water Boilers

Boiler pressure and the method of mounting are the primary factors to consider when selecting a low water cut-off.

Maximum Boiler Pressure psi (kg/cm ²)	Method of Installation		Product Series	Size NPT	Blow Down Valve	
	Directly into Boiler Tappings OR on the Boiler Supply Riser*	To Piping Above the Boiler with 1" (25mm) Equalizing Piping			Required	Provided with Low Water Cut-Off
50 (3.5)	X		RB-24	3/4	No	N/A
		X	63	1	Yes	No
		X	64	1	Yes	No
	X		64-A	1/2	Yes	Yes
	X		764	2 1/2	Yes	No
160 (11)	X		PS-850	3/4	No	N/A
	X		RB-120	3/4	No	N/A
	X		RB-122E	3/4	No	N/A
160 - 250 (11-18)	X		750/750B/750P	3/4 - 1	No	N/A

* Use the tapping designated by the boiler manufacturer for low water cut-off installation.