

# Cable Ladders

## Ladder Sections

CUSTOM WIDTHS AND RUNG PLACEMENT AVAILABLE. CALL FOR DETAILS.

A complete line of 12", 18", and 24" wide, fully welded cable ladders. Cable ladder sections ship fully boxed, which minimizes product damage and simplifies shipping and storage. Highly durable finish consists of 2 layers of black powder coat and is exceptionally scratch resistant. Compatible with most popular brands and accessories of cable ladders, these will work on both new and retrofit installations.



EIA/TIA Compliant



Spec. # 96-986 for full product info.

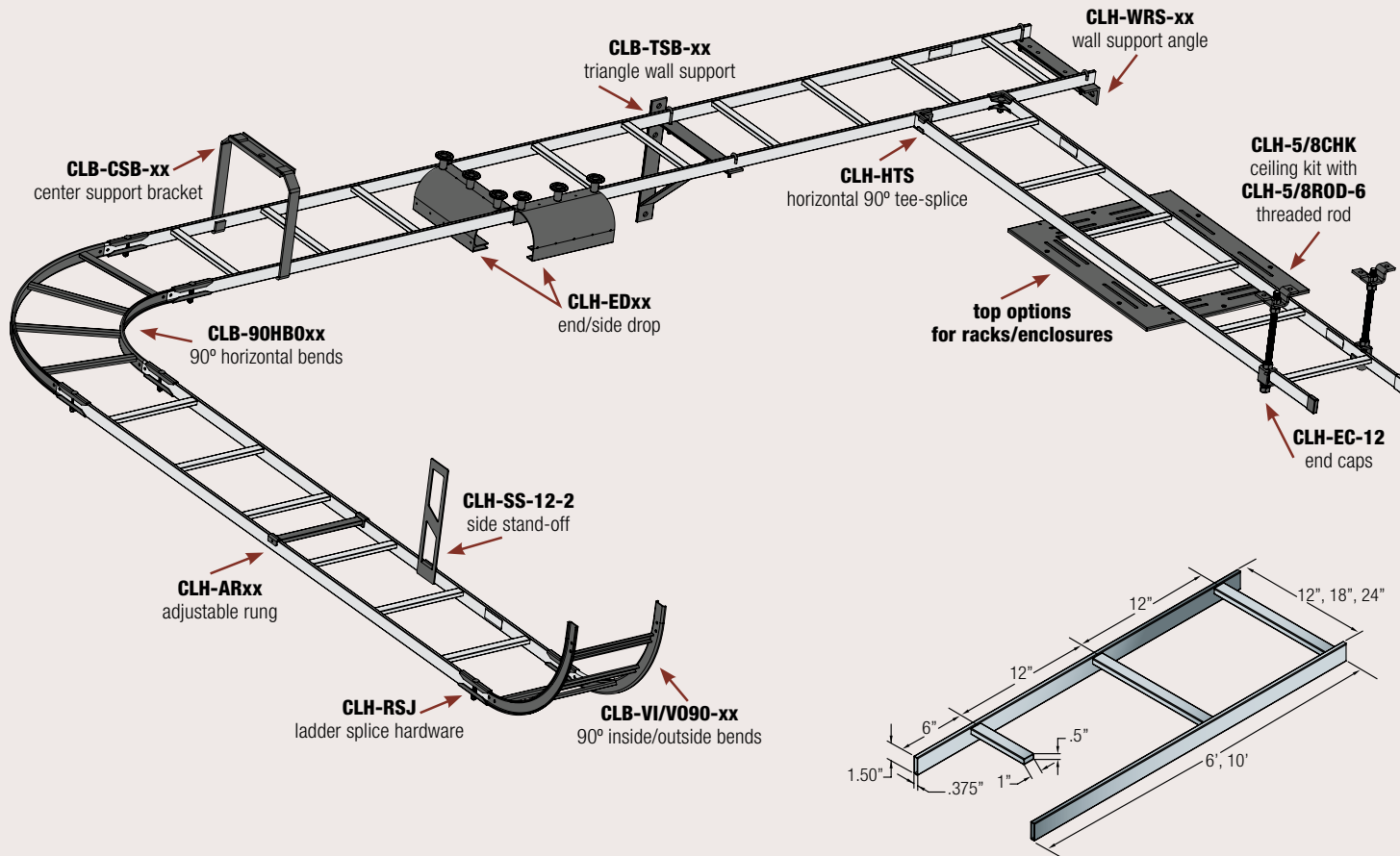

| 12" Wide Bulk Packs   | 12" Wide Part # | 18" Wide Part # | 24" Wide Part # | Description                             |
|-----------------------|-----------------|-----------------|-----------------|---|
| CLB-6-12 (12 pieces)  | CLB-6           | CLB-6-W18       | CLB-6-W24       | 6' long straight ladder section, black  |
| CLB-10-12 (12 pieces) | CLB-10          | CLB-10-W18      | CLB-10-W24      | 10' long straight ladder section, black |
| CLB-90HB-4 (4 pieces) | CLB-90HB        | CLB-90HB-W18    | CLB-90HB-W24    | 90° horizontal bend, black              |
| CLB-VI90-4 (4 pieces) | CLB-VI90        | CLB-VI90-W18    | CLB-VI90-W24    | 90° vertical inside bend, black         |
| CLB-V090-4 (4 pieces) | CLB-V090        | CLB-V090-W18    | CLB-V090-W24    | 90° vertical outside bend, black        |

## Junction and Splice Hardware - All Hardware has Black Finish

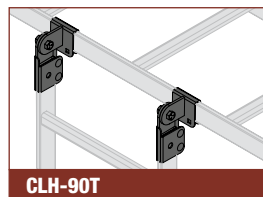
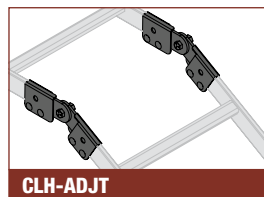
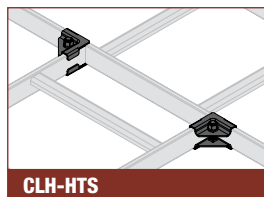
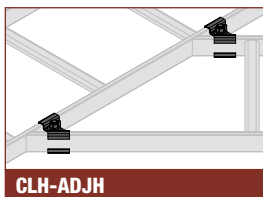

| Part #     | Qty     | Description                           |
|------------|---------|---------------------------------------|
| CLH-ADJH   | 1 pair  | adjustable horizontal splice hardware |
| CLH-ADJH-6 | 6 pairs | adjustable horizontal splice hardware |
| CLH-RSJ    | 1 pair  | ladder end splice hardware            |
| CLH-RSJ-6  | 6 pairs | ladder end splice hardware            |
| CLH-HTS    | 1 pair  | horizontal 90° tee splice hardware    |

| Part #     | Qty     | Description                           |
|------------|---------|---------------------------------------|
| CLH-HTS-6  | 6 pairs | horizontal 90° tee splice hardware    |
| CLH-ADJT   | 1 pair  | adjustable ladder end splice hardware |
| CLH-ADJT-6 | 6 pairs | adjustable ladder end splice hardware |
| CLH-90T    | 1 pair  | adjustable 90° tee splice hardware    |
| CLH-90T-6  | 6 pairs | adjustable 90° tee splice hardware    |



# Cable Ladders

## Wall/Ceiling Mounts - All Hardware has Black Finish

CUSTOM WIDTHS AND RUNG PLACEMENT AVAILABLE. CALL FOR DETAILS.

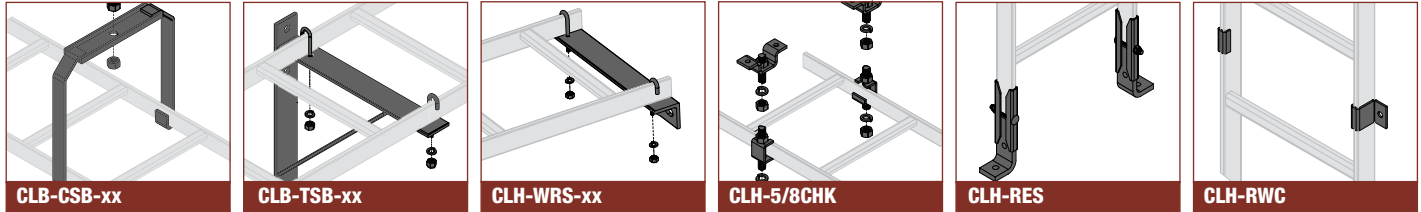

| 12" Wide (Bulk 6 Pack) | 12" Wide Part #           | 18" Wide Part # | 24" Wide Part # | Description                                  |
|------------------------|---------------------------|-----------------|-----------------|--|
| CLB-CSB-6              | CLB-CSB                   | CLB-CSB-W18     | CLB-CSB-W24     | center support bracket                       |
| CLB-TSB-6              | CLB-TSB                   | CLB-TSB-W18     | CLB-TSB-W24     | triangle wall support bracket                |
| CLH-WRS-6              | CLH-WRS or CLH-WRS-W6-W12 | CLH-WRS-W18-W24 | CLH-WRS-W18-W24 | ladder wall support angle                    |
| CLH-5/8CHK-6           |                           | CLH-5/8CHK      |                 | 5/8" slotted ceiling kit, fits all widths    |
| -                      |                           | CLH-5/8ROD-12-4 |                 | 12" long section 5/8" threaded rod, 4 pieces |
| -                      |                           | CLH-5/8ROD-6    |                 | 6" long section 5/8" threaded rod, 1 piece   |
| CLH-RES-6              |                           | CLH-RES         |                 | ladder end support hardware, fits all widths |
| CLH-RWC-6              |                           | CLH-RWC         |                 | ladder wall clamp, fits all widths           |

## Side, End Drops and Adjustable Rungs

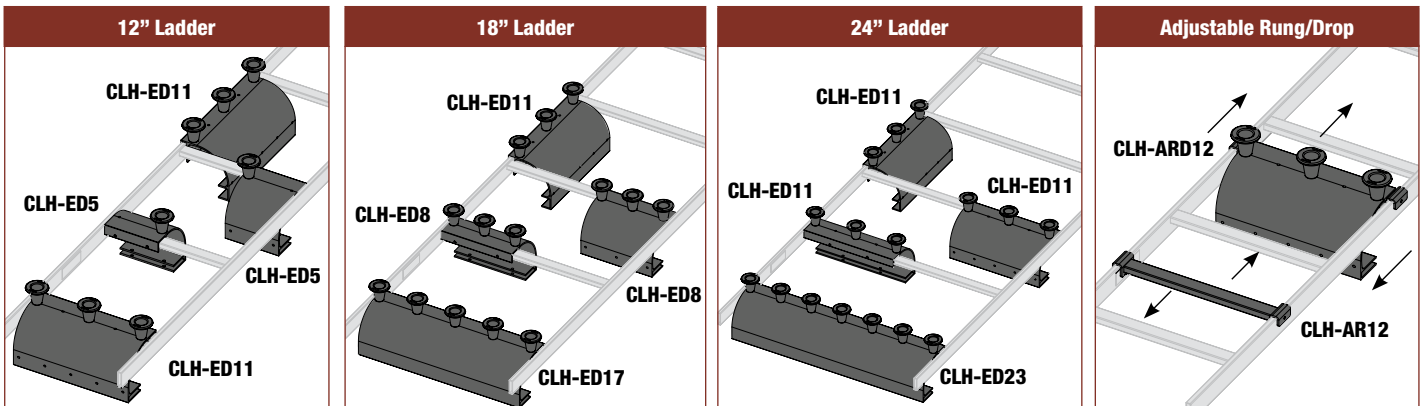

| 12" Wide (Bulk 4 Pack) | 12" Wide Part # | 18" Wide Part # | 24" Wide Part # | Description                                    |
|------------------------|-----------------|-----------------|-----------------|--|
| -                      | CLH-AR12        | CLH-AR18        | CLH-AR24        | adjustable rung (no drop)                      |
| -                      | CLH-ARD12       | CLH-ARD18       | CLB-ARD24       | adjustable rung drop with spools               |
| CLH-ED11-4             | CLH-ED11        | CLH-ED17        | CLH-ED23        | end drop with spools                           |
| -                      |                 | CLH-ED5         |                 | 5" wide end drop with spools, fits all widths  |
| -                      |                 | CLH-ED8         |                 | 8" wide end drop with spools, fits all widths  |
| CLH-SD8-4              |                 | CLH-SD8         |                 | 8" wide side drop with spools, fits all widths |

## Accessories

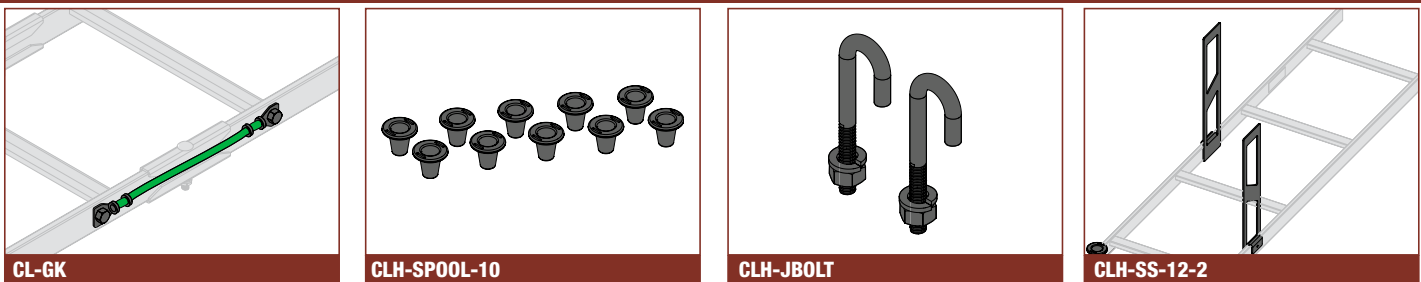

| Part #          | Description                                  | Part #       | Description  |
|-----------------|--|--------------|--|
| CL-GK           | cable ladder bonding kit                     | CLH-5/8ROD-6 | 6' long section 5/8" threaded rod, 1 piece                   |
| CLH-EC-12       | cable ladder end caps (12 pieces)            | CLH-SS-12-2  | 12" high, side stand-off, 2 pieces                           |
| CLH-JBOLT       | 5/16" J-bolts and nuts (1 pair)              | MK-LA        | ladder adapter kit for MK-19-45-RL & RLA Series racks        |
| CLH-SPOOL-10    | cable management spools (10 pieces)          | MW-LA        | top option for DRK, MRK, WRK, VRK and VMRK Series enclosures |
| CLH-5/8ROD-12-4 | 12" long section 5/8" threaded rod, 4 pieces |              |  |

