

Options and Accessories

➤ CONNECTIONS AND FITTINGS

Many thread types and sizes are manufactured on Tel-Tru CNC machines. 304SS and 316SS.



➤ LENSES

Shatterproof and tempered glass, acrylic and polycarbonate plastic.



➤ DIALS

Precision pad printing of custom logos, colored zones and special information on all dial sizes.



➤ TAGGING

Paper, aluminum, 304SS or 316SS tags for engineering project requirements.

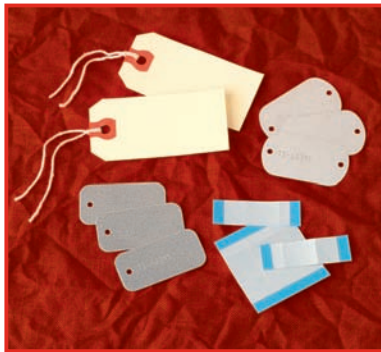

➤ MOUNTING FLANGES

Various size mounting flanges for OEM and duct applications.



➤ THERMOWELL ADAPTER KIT:

The AS-86 adapter kit was designed as a simple means of converting existing Industrial Glass Thermometer Wells for use with Bimetal Thermometers.

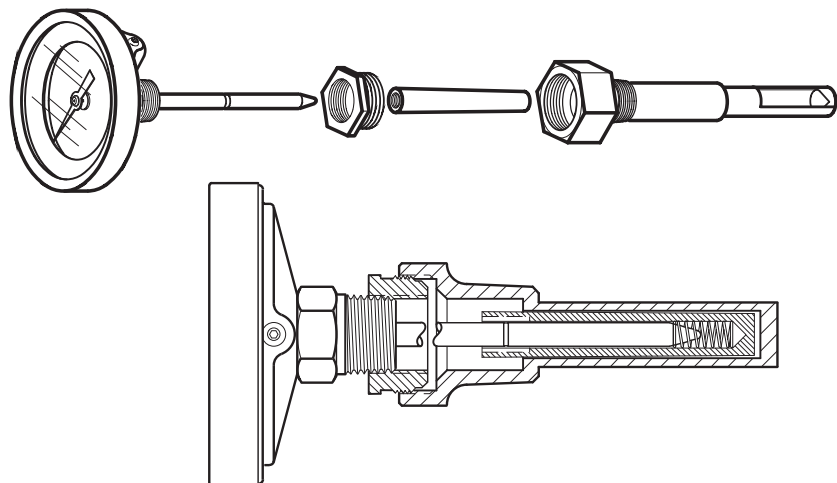
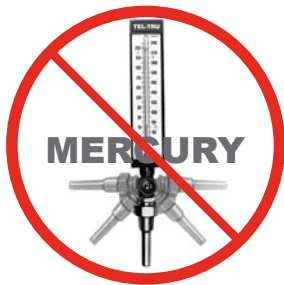

Thermowells

Recommended for pressure, corrosive fluid and high velocity applications.

➤ SEE TEL-TRU THERMOWELL CATALOG

For complete dimensions, sizes, available materials, optional features and configurations. For technical data on pressure and temperature ratings and maximum fluid velocity see <http://www.teltru.com>

➤ THREADED



Stepped

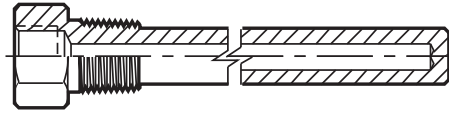

Straight

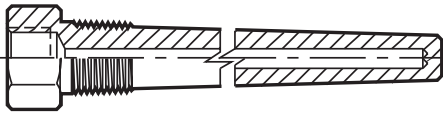

Tapered

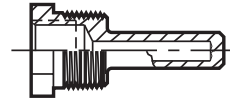

Limited Space

➤ FLANGED

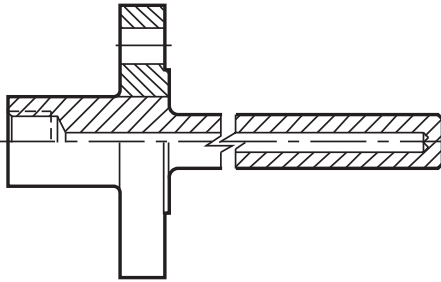

Straight

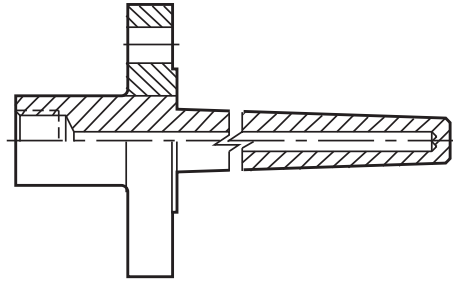

Heavy Duty Tapered

➤ WELDED

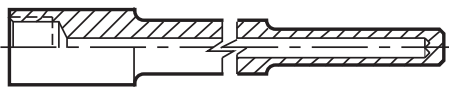

Socket Weld

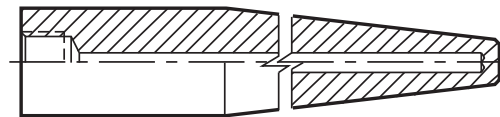

Weld-In

➤ SANITARY

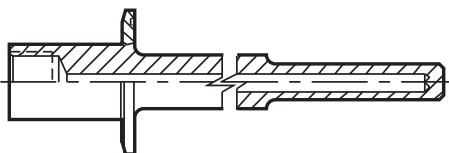

➤ VAN STONE

