

**VERIS**

*Superior Flow Measurement Accuracy  
with No Straight Run Requirements and  
Operating Ranges Never Before Attainable  
...Until Now*

**Accelabar<sup>®</sup>**



# Accelabar... A New Idea in Flow Measurement

## The Unique Accelabar Flow Meter

The Accelabar is a new and unique flow meter that combines two differential pressure technologies to produce operating ranges never before attainable in a single flow meter. It is capable of generating high differential pressures for measuring gas, liquids and steam at turndowns previously unattainable — with no straight run requirements.

### How the Accelabar Works

The Accelabar consists of a unique toroidal nozzle design and a Verabar averaging pitot. The nozzle has a patented straight run "settling distance" that accelerates, linearizes and stabilizes the velocity profile sensed by the Verabar. The Verabar located within the nozzle accurately measures and significantly increases the differential pressure output to increase the operating range (turndown). The Accelabar has a constant flow coefficient and produces an accuracy of up to  $\pm 0.50\%$ .

*Other manufacturers claim high accuracy, but over a limited turndown.*

### No Straight Run Required

The Accelabar can be used in extremely limited straight run piping configurations. The straight run is integral to the meter. The stabilization and linearization of the velocity profile within the throat of the nozzle eliminates the need for any upstream run.

### Engineering Specifications

- Low velocity flow rates
- High accuracy: to  $\pm 0.50\%$
- Repeatability:  $\pm 0.050\%$
- Verified flow coefficients
- No calibration required
- Extended turndown
- No straight run requirements
- Low permanent pressure loss
- Mass or volumetric flow

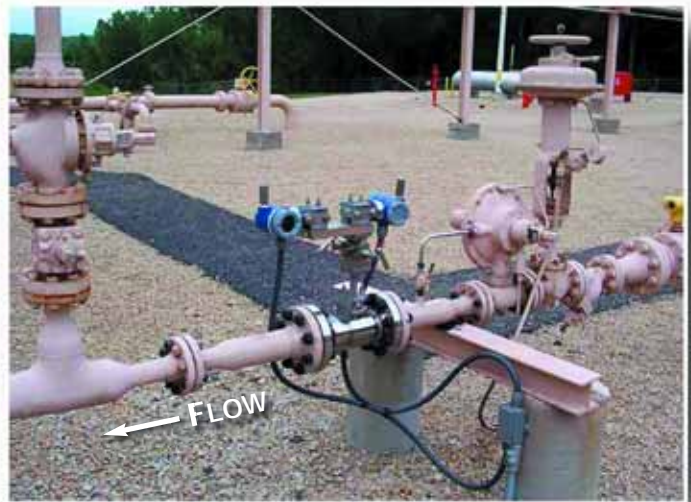
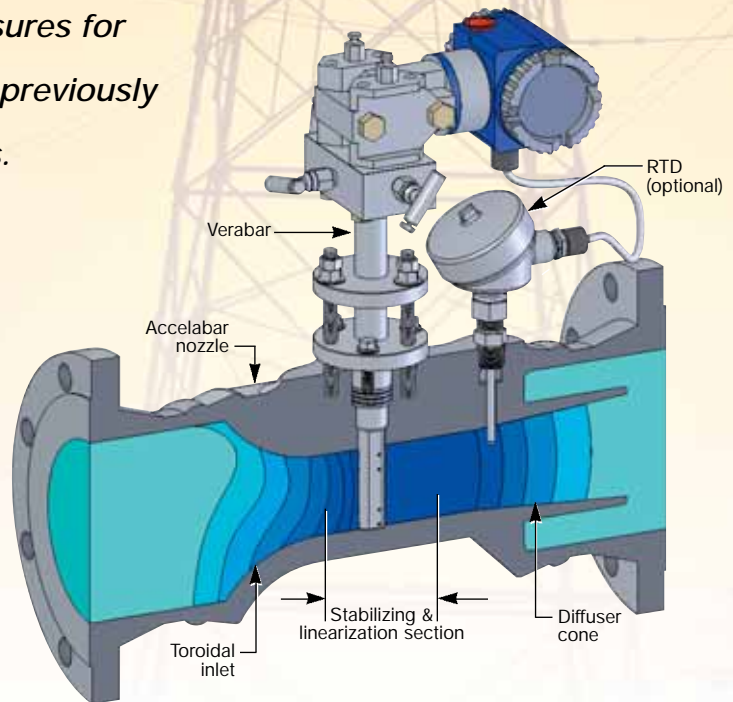

### Actual Application (see data on page 4)

**Application:** 3" Sch 40 Natural Gas  
**Operating Pressure/ Temperature:** 50 PSIG/70° F  
**Max/Min Flow Rate:** 60,000 SCFH/1,000 SCFH  
**Flow Turndown:** 60:1  
**Straight Run:** 0"

US Patent No. 6,868,741 B2 and various foreign patents pending.

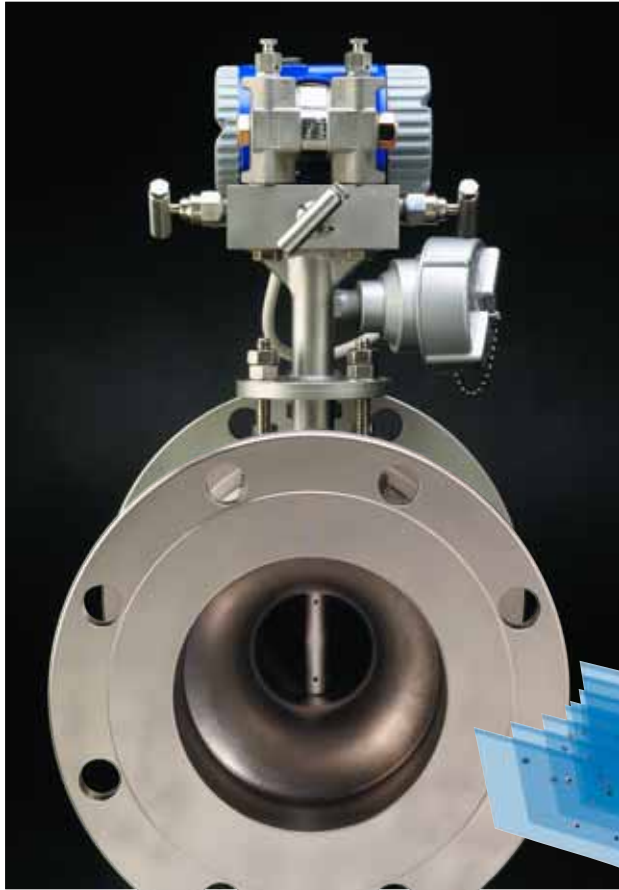

## Verabar Provides the Accuracy

The proven technology of the Verabar makes the Accelabar work. It accurately measures the flow rate within the nozzle. Its unique bullet shape, constant flow coefficient, solid one-piece construction, non-clog design and signal stability make it the only design capable of producing the overall performance.

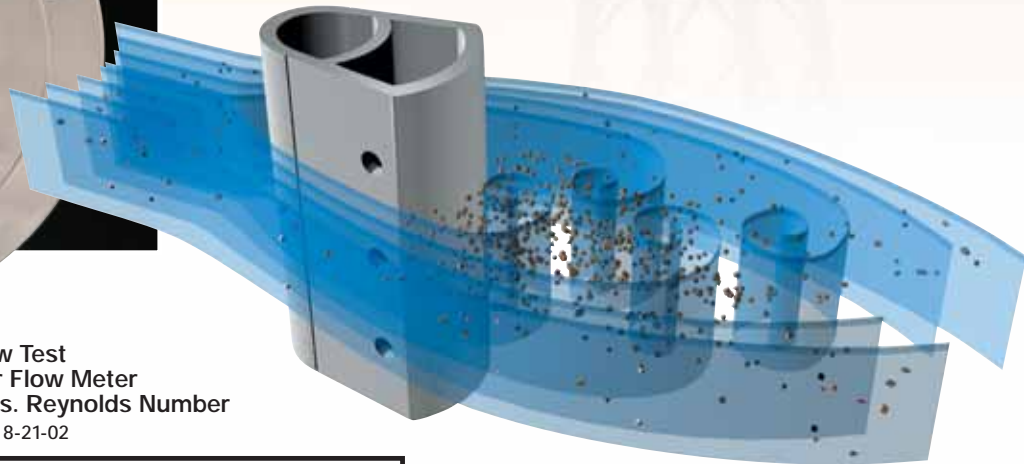

Flow Test  
Accelabar Flow Meter  
Flow Coefficient vs. Reynolds Number  
Date 8-21-02

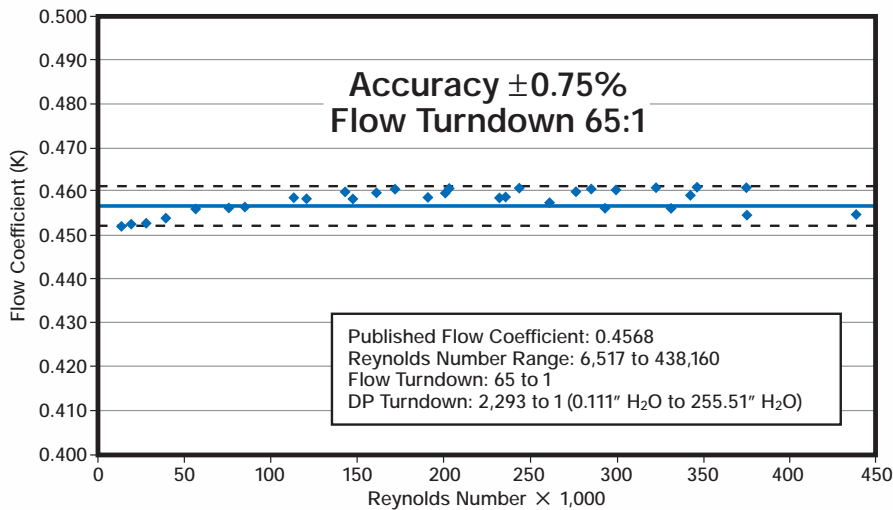

## Verified Accuracy and Flow Coefficients

Empirical test data from independent laboratories verified an analytical model and flow coefficients as constant and independent of Reynolds Number and within  $\pm 0.75\%$  of the predicted value over a flow turndown of 65:1 (see actual test). ***This eliminates the need for calibration.***

# The Best Choice in Flow Meters

## Comparative Analysis vs. Other Flow Meters

The Accelabar fills the need not presently being filled by other flow meters for applications that:

- Do not have sufficient velocity to produce a readable signal or sufficient turndown
- Require the highest accuracy over an extended range
- Have little or no straight run piping before the meter

The Accelabar performance characteristics far exceed those of other DP meters, vortex meters and many other flow meters.

These charts show the actual performance characteristics of the Accelabar versus other flow meters based on the following flow conditions:

### Flow Conditions

Fluid	Natural Gas
Pipe Size	3" Sch 40
Max Flow	60,000 SCFH
SG	0.6
Pressure	50 psig
Temperature	70°F
Pipe Line Velocity	74 ft/sec

### Accelabar Increased Velocity

Fluid Velocity — Pipe Line vs. Accelabar Throat

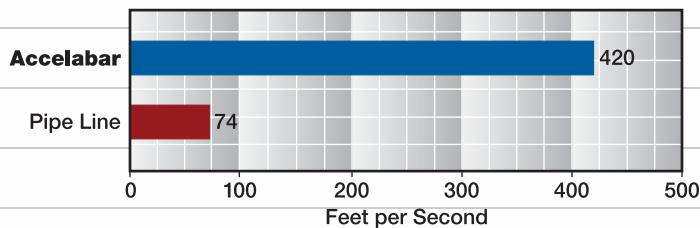

### DP at Maximum Flow

Inches H<sub>2</sub>O — 3" Natural Gas 60,000 SCFH

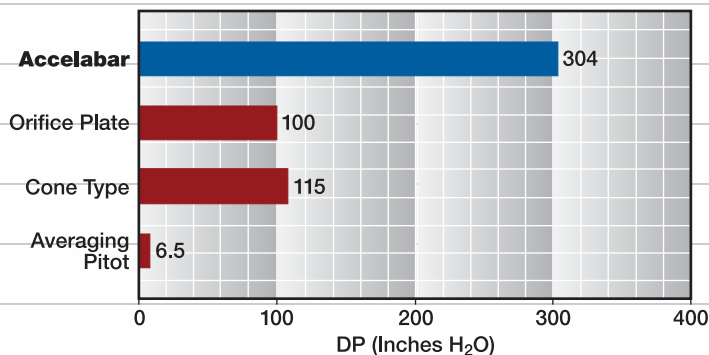

### Flow Turndown

Maximum & Minimum

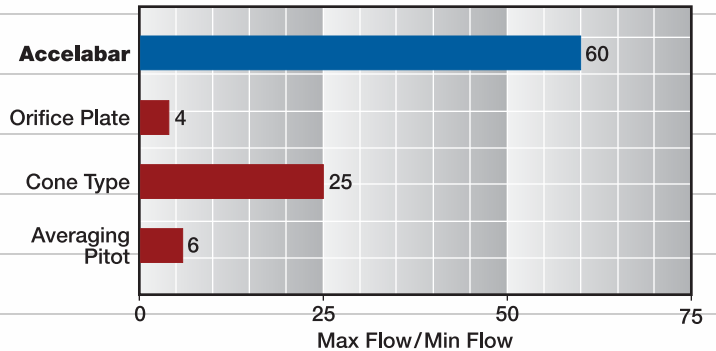

### Flow Turndown

Accelabar vs. Vortex

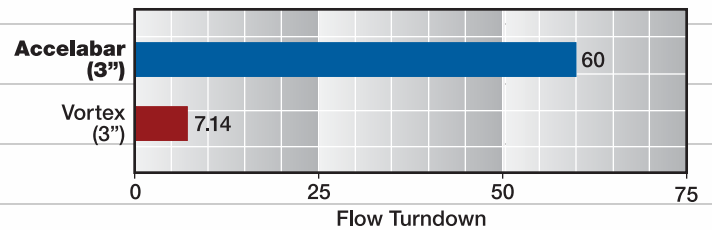

### Minimum Straight Run Requirements

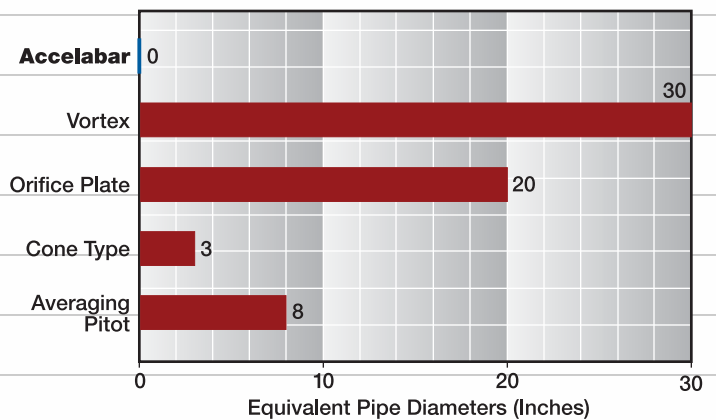

### Permanent Pressure Loss

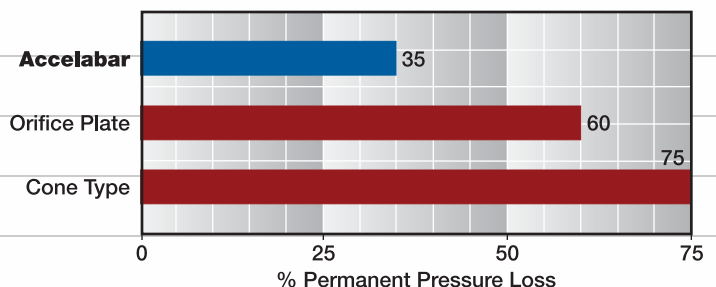

## The Proof Is In The Data

Many flow meters claim high accuracy and rangeability or turndown. However, few manufacturers define their limitations and even fewer can support it with actual test data. The tests below show the performance capabilities of the Accelabar.

### Turndown Test

**Flow Test**  
**Accelabar Flow Meter**  
**Flow Coefficient vs. Reynolds Number**  
 Date 8-21-02

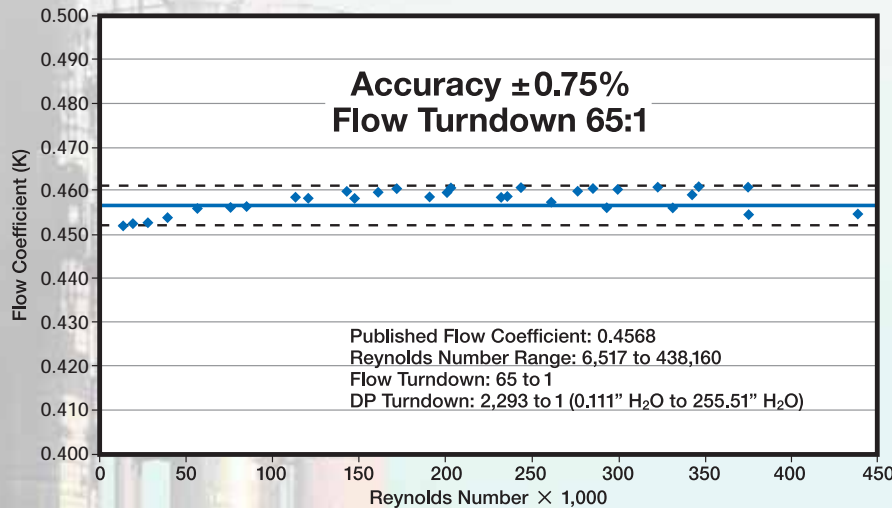

### Test Specifications\*

Pipe Size: 3" sch 40  
 Fluid: Air  
 Flow Rate: 145 ACFM  
 Max Pressure: 60 psig  
 Max Temperature: 75°F

### Results

The Accelabar produced a DP of 255.5" H<sub>2</sub>O at 145 ACFM. An accuracy of ±0.75% was maintained over a Reynolds Number range of 65 to 1. No other flow meter is capable of this operating range.

\*Independent, NIST traceable tests were performed as follows:

- Air tests in 3", 4", 6" and 12" pipes
- NIST traceable water tests
- Large turndown natural gas testing
- Short straight-run testing

Consult factory for a copy of certified tests.

### No Straight Run Test Comparison

#### Test Specifications

The Accelabar was tested immediately downstream of a valve, tee and expander assembly with no straight run upstream.

**Flow Test**  
**Accelabar Standard and Short Run Tests**  
**Flow Coefficient vs. Equivalent Gas (mSCFD\*)**  
 Meter Diameter: 1.35" Test Dates: 8-21-02, 11-7-02

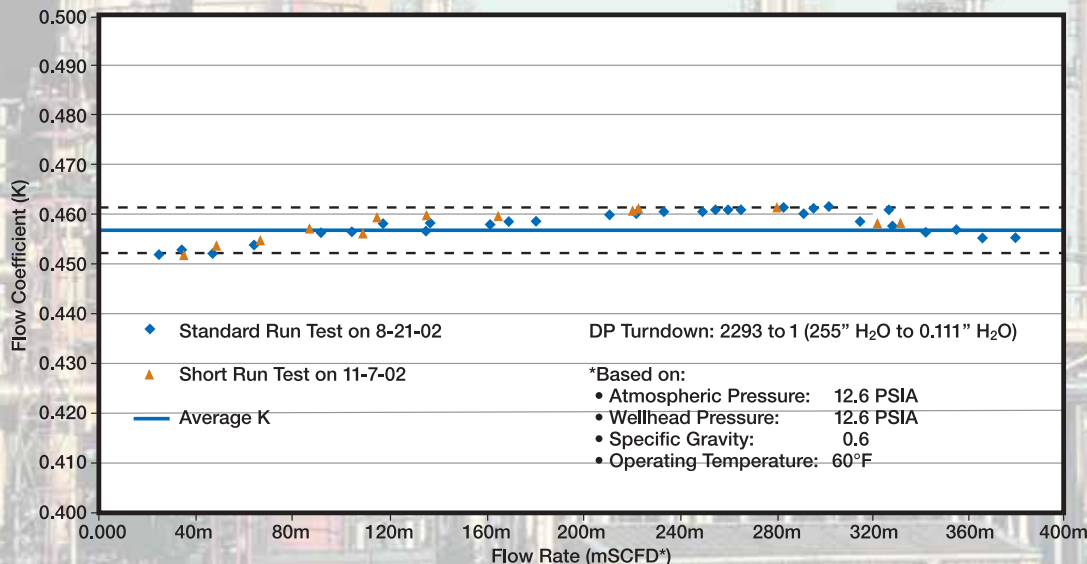

#### Results

The short run test plotted with the standard straight run test verifies there is no shift in the flow coefficient.



# Models and Specifications

## Ready to Install

The Accelabar is a complete flow meter ready to install. It comes complete with single or dual transmitters depending on the turndown requirements.

An optional RTD is supplied in a Thermowell for dynamic compensation (required for use with multivariable transmitter).

## AF Flanged Model

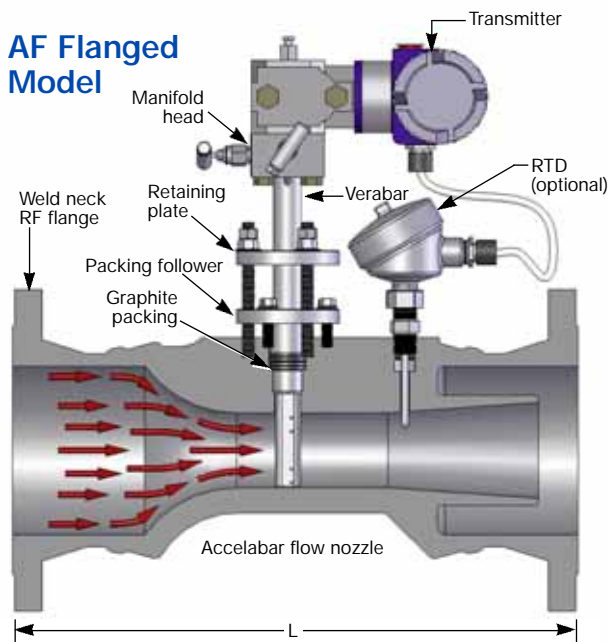

## Accelabar Model Selection

- Furnish your flowing conditions. A flow calculation is required to determine the DP and verification of the operating limits.
  - Each meter size has a standard beta ratio sized for the optimal operating range.
  - The maximum operating limits are determined by the Accelabar flow calculation.

- If your flowing conditions exceed the operating limits, a larger or smaller model (meter size) must be selected.

## Flowing Conditions

General Data	Fluid Parameters	Maximum	Normal	Minimum	Units
Tag number	Flow Rate				
Pipe size & schedule or exact ID & wall thickness	Pressure				
	Temperature				
Fluid name:	Density*				

\*Density is not required for steam applications.

## Dual Transmitter

## Single Transmitter

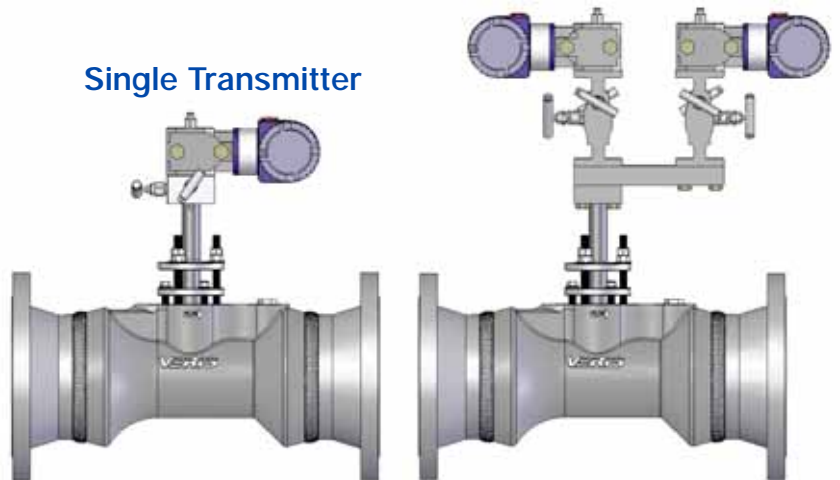

## Chart A











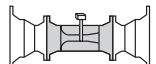
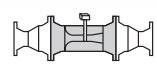

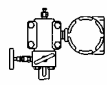
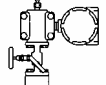
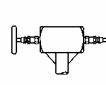
Meter Size	Verabar Sensor	Face to Face "L"*		
		150#	300#	600#
3" (75mm)	-05 1/2"	13.78"	14.53"	15.28"
4" (100mm)	-05 1/2"	15.15"	15.90"	17.65"
6" (150mm)	-10 1"	19.15"	19.90"	21.90"
8" (200mm)	-10 1"	21.40"	22.15"	24.40"
10" (250mm)	-10 1"	23.15"	24.40"	27.65"
12" (300mm)	-10 1"	26.17"	27.78"	29.67"

\* Face to face dimensions nominal. Custom lengths available.

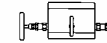
## Specifications

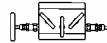
Accuracy	Repeatability	Sensor, Body & Flange
to $\pm 0.50\%$	$\pm 0.050\%$	316SS

# Ordering Information

<b>Model</b>	Accelabar 316SS										
<b>AFS ABS</b>	Flanged Connections Bevel for Weld										
<b>User Mating Pipe Size and Schedule or Exact ID and Wall Thickness</b>											
<b>Code</b>	<b>User Mating Flange (Model AFS Only)</b>										
150 300 600	150# ANSI Class 275 psig @ 100°F, 80 psig @ 800°F (19 Bars @ 38°C, 5.5 Bars @ 426°C) 300# ANSI Class 720 psig @ 100°F, 330 psig @ 800°F (49.6 Bars @ 38°C, 22.8 Bars @ 426°C) 600# ANSI Class 1440 psig @ 100°F, 660 psig @ 800°F (99.3 Bars @ 38°C, 45.5 Bars @ 426°C) If other than ANSI, specify Standard (DIN, JIS) Size and Rating										
<b>Code</b>	<b>Flange Material</b>										
C S	Carbon Steel Stainless Steel										
<b>Accelabar Meter Size</b>											
<i>Important: If the selected meter size is larger or smaller than the user's mating pipe and flange, expanders or reducers are required. Consult the factory for price and delivery.</i>											
 											
3" (75mm)		4" (100mm)		6" (150mm)		8" (200mm)		10" (250mm)		12" (300mm)	
<b>Code</b>	<b>Verabar Size</b>										
05 10	7/16" (11mm) 7/8" (22mm)										
<b>Code</b>	<b>Pipe Orientation</b>										
H V	Horizontal Vertical										
<b>Instrument Head Connections (Select Remote or Direct Mount Transmitter—Sold Separately)</b>											
 <b>Direct Mount Transmitter</b> (Flanged 450°F/232°C Max.)						 <b>Remote Mount Transmitter</b> (1/2" NPT)					
Manifold		Transmount		Valve		Regular		Parallel			
											
Integral		Integral		Integral							
<b>M</b>		<b>F</b>		<b>T</b>		<b>R</b>		<b>P</b>			
<b>Manifolds (Optional)</b>						<b>Instrument Valves (Optional)</b>					
 <b>Direct Mount</b>						 <b>Remote Mount</b>					
3-Valve			5-Valve			Needle		Gate			
											
Soft Seat		Hard Seat	Soft Seat		Hard Seat	1/2" NPT		1/2" NPT			
<b>F3SC (CS)</b> <b>F3SS (SS)</b>		<b>F3HC (CS)</b> <b>F3HS (SS)</b>	<b>F5SC (CS)</b> <b>F5SS (SS)</b>		<b>F5HC (CS)</b> <b>F5HS (SS)</b>	<b>C2NC (CS)</b> <b>C2NS (SS)</b>		<b>C2GC (CS)</b> <b>C2GS (SS)</b>			
<b>Code</b>	<b>RTD in Thermowell</b>										
H1 H2 HT NH	Hazardous Location, Class 1 Div 1, Explosion Proof Hazardous Location, Class 1 Div 2, Non-Incendive Wiring High Temperature (500°F to 900°F, 260°C to 482°C) Non-Hazardous Location										
<b>Code</b>	<b>Connection Cable to Transmitter (Direct Mount Only)</b>										
XP N4	Explosion Proof (hazardous locations) NEMA 4										
Optional	Optional	Optional	Optional	Optional	Optional	Optional	Optional	Optional	Optional	Optional	Optional
AFS 6" Sch 40 150 SS 4" 05 H R C2NC H2 XP For Transmitter Selection, see Page 8.											

# Accelabar...The Right Choice

## Transmitter Selection

**Accelabar accuracy is percent of rate.** The Accelabar maintains a constant flow coefficient over a wide range of flow rates and differential pressures.

**DP transmitter accuracy is percent of scale.** While most Accelabar installations are equipped with one DP transmitter, some applications requiring superior accuracy over an extreme DP turndown may require a dual DP transmitter installation.

Single Transmitter

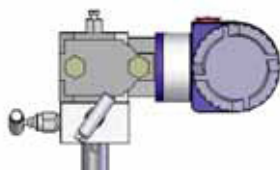

Dual Transmitter

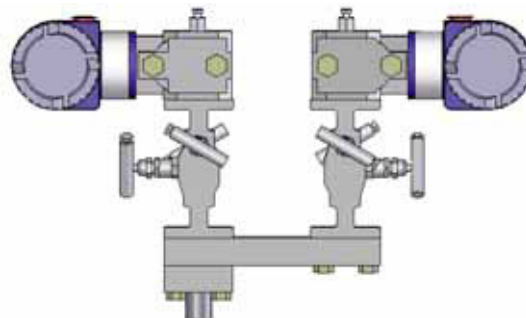

## Installation Orientation

### Direct Mount

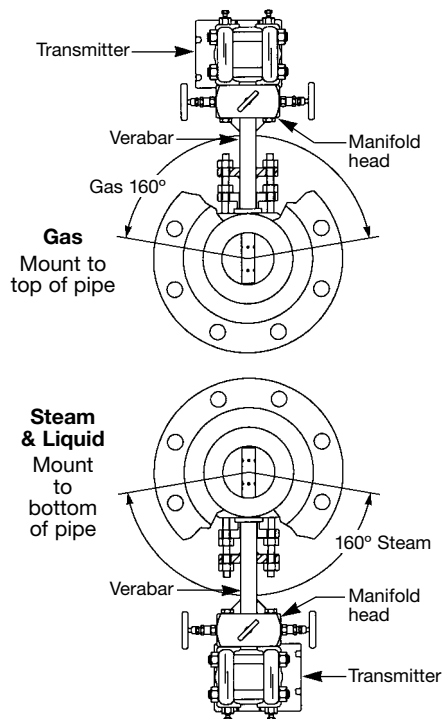

### Remote Mount

