

Ball Valves

1/4" to 2", 2-Way

1/4" to 1", 2-Way Vented

Plug Valves

1/8" to 1/4" Pipe Size

Section E



E

Product Index











Ball Valves

Stainless Steel Ball Valves

Plug Valves

Product Index	E2
Ball Valves	
Basic Features	E3
Part Numbers & Dimensions.....	E4
Stainless Steel Ball Valves	E5

Plug Valves	
Basic Features	E6
Part Numbers & Dimensions.....	E7
Drain Cocks	
Basic Features	E8
Part Numbers.....	E8

E	Brass Ball Valves	XV500P Female-Female  Page E4	MV200 Mini Valve  Page E4	MV608 Mini Valve  Page E4	MV609 Mini Valve  Page E4		
	Stainless Steel Valves	XV502SS Female-Female  Page E5					
	Plug Valves & Drain Cocks	PV607 Male-Male Plug Valve  Page E7	PV608 Male-Female Plug Valve  Page E7	PV609 Female-Female Plug Valve  Page E7	DC602 Internal Seal Drain Cock  Page E8	DC604 External Seal Drain Cock  Page E8	

E	Product Index
Ball Valves	
Stainless Steel Ball Valves	
Plug Valves	

Materials of Construction	
Valve Body:	Forged brass
Ball:	Chrome plated brass
Seats / Seals:	PTFE
Handle:	Steel

Style	Type	Material	Size	Options
V	500	P	-4	-00
Style	<ul style="list-style-type: none"> •V-Valve •VP-Valve, Padlocking handle •VV-Valve, Vented •VVP-Valve, Vented, Padlocking handle 			
Type	500-Female / Female PTF ports			
Material	P- Brass PN-Nickel plated			
Size	4 = 1/4", 6 = 3/8", 8 = 1/2", 12 = 3/4", 16 = 1", 20 = 1-1/4", 24 = 1-1/2", 32 = 2"			
Options	<ul style="list-style-type: none"> •01-Stainless steel ball & stem •02-Stainless steel handle & nut •03-Stainless steel ball, stem, handle & nut •04-Tee handle •08-Unmarked yellow vinyl handle cover •21-Oval handle 			



Parker's industrial ball valve product line is intended for general purpose use. Please be aware that ball valves are intended for use in the fully open or closed positions. Depending on application conditions, throttling of the valve may result in premature seal failure and/or inability to turn the valve handle.

For use as fuel line shutoffs for gasoline and diesel powered over the highway, off highway, and construction equipment vehicles. Water and air service lines on capital equipment and plant design plumbing that require total shutoff capability.

Specifications	
Operating Instructions:	Quarter turn is "ON" or "OFF". (Provides positive stop action for full shutoff.)
Pressure Range:	<ul style="list-style-type: none"> •600 WOG, cold non-shock •Saturated steam up to 150 PSI and 400°F •Vacuum service to 29 inches Hg. •Vented up to 250 PSI
Temperature Ranges:	0° to +350°F
Note:	Periodically check the adjustable packing nut and tighten as required.

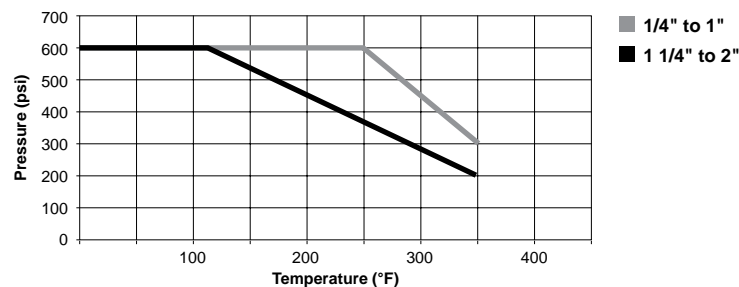

Flow Data	
Valve Size	Cv
1/4	4.0
3/8	5.8
1/2	12.0
3/4	25.0
1	35.0
1-1/4	57.0
1-1/2	92.0
2	224.0

E
Product Index
Ball Valves
Stainless Steel Ball Valves
Plug Valves

Part Numbers

Ball Valves, Plug Valves and Drain Cocks
Brass Ball Valves

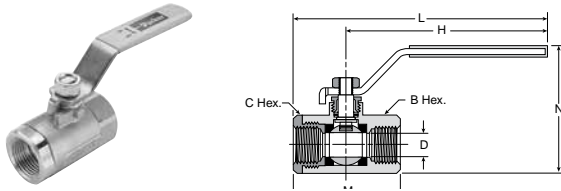

Female-Female Pipe Ends XV500P

Part No.	Pipe Thread	B Hex	C Hex	H	L	M	N	Flow Dia. D
XV500P-4	1/4	15/16	15/16	3.96	4.90	2.03	2.47	.375
XV500P-6	3/8	15/16	15/16	3.96	4.90	2.03	2.47	.375
XV500P-8	1/2*	1-1/16	1-1/16	3.96	5.00	2.20	2.58	.500
XV500P-12	3/4**	1-1/4	1-5/16	3.96	5.25	2.42	2.81	.685
XV500P-16	1**	1-1/2	1-9/16	3.96	5.34	2.75	3.08	.875

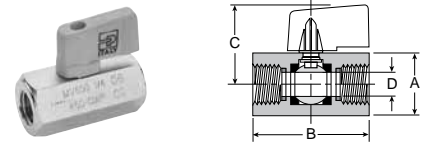

Female Pipe Ends, Compact Handle, Mini Ball Valve MV609

Part No.	Pipe Thread	A Hex	B	C	Flow Dia. D
MV609-2	1/8	.83	1.71	1.22	.24
MV609-4	1/4	.83	1.71	1.22	.31
MV609-6	3/8	.83	1.71	1.22	.31
MV609-8	1/2	.98	2.11	1.30	.39
MV609-6-4	3/8x1/4	.83	1.71	1.22	.31

E

Product Index

Ball Valves

Stainless Steel Ball Valves

Plug Valves

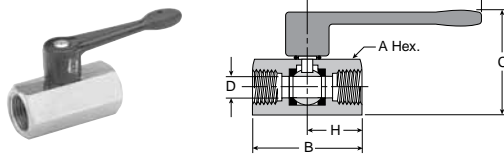

Female Pipe Ends, Lever Handle, Mini Ball Valve MV200

Part No.	Pipe Thread	A Hex	B	C	H	L	Flow Dia. D
MV200-2	1/8	.83	1.71	1.20	.91	2.83	.31
MV200-4	1/4	.83	1.71	1.20	.91	2.83	.31
MV200-6	3/8	.83	1.71	1.20	.91	2.83	.31
MV200-8	1/2	.98	2.11	1.28	1.10	2.83	.39

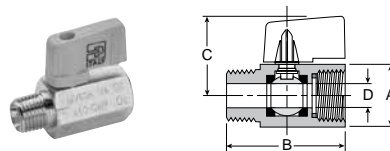

Male-Female Pipe Ends, Compact Handle, Mini Ball Valve MV608

Part No.	Pipe Thread	A Hex	B	C	Flow Dia. D
MV608-2	1/8	.83	1.72	1.22	.20
MV608-4	1/4	.83	1.72	1.22	.31
MV608-6	3/8	.83	1.72	1.22	.31
MV608-8	1/2	.98	2.11	1.30	.39

Materials of Construction	
Valve Body:	CF-8M Stainless Steel
Ball:	Stainless Steel
Seats / Seals:	PTFE
Handle:	Stainless Steel

Pressure and Temperature Range	
Pressure Range	2,000 PSI Sizes: 1/4" - 1" 1,500 PSI Sizes: 1-1/4" - 2"
Temperature Range	0° to +400°F

Style	Type	Material	Size	Options
V	502	SS	-4	-00
Style	V - Valve VP - Valve, Padlocking handle			
Type	502-Panel mount female/Female PTF ports			
Material	SS-stainless steel			
Size	4 = 1/4", 6 = 3/8", 8 = 1/2", 12 = 3/4", 16 = 1", 20 = 1-1/4", 24 = 1-1/2", 32 = 2"			
Options	20 - Short handle 21 - Oval handle 35 - Welded retainer nut			

Approvals
Meets material requirements of NACE MR-01-75



Parker's industrial ball valve product line is intended for general purpose use. Please be aware that ball valves are intended for use in the fully open or closed positions. Depending on application conditions, throttling of the valve may result in premature seal failure and/or inability to turn the valve handle.

Applications include chemical plants, refineries, steel mills, industrial fuel lines and agricultural equipment. Meets material requirements of NACE MR-01-75.

Flow Data	
Valve Size	Cv
1/4	4.0
3/8	6.0
1/2	14.0
3/4	35.0
1	54.0
1-1/4	74.0
1-1/2	120.0
2	226.0

Note: Periodically check the adjustable packing nut and tighten as required.

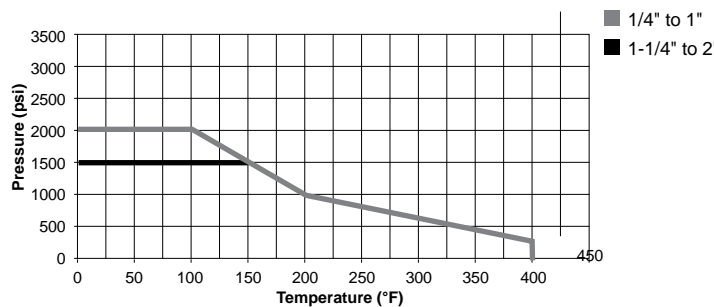

Mounting Detail

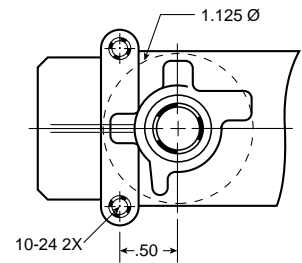

Female Pipe Ends, Panel Mount XV502SS

Part No.	Pipe Thd (NPT)	B/C Hex	F	G	H	I THD	L	M	N	Panel Flow Dia. D	Hole Dia.
XV502SS-4	1/4	15/16	.500	1.125	4.00	10-24 UNC	5.03	2.07	2.52	.380	1.125
XV502SS-6	3/8	15/16	.500	1.125	4.00	10-24 UNC	5.03	2.07	2.52	.380	1.125
XV502SS-8	1/2	1-1/16	.500	1.125	4.00	10-24 UNC	5.13	2.27	2.65	.500	1.125
XV502SS-12	3/4	1-3/8	.875	1.375	5.00	10-24 UNC	6.67	3.35	3.46	.790	1.500
XV502SS-16	1	1-5/8	.875	1.375	5.00	10-24 UNC	6.77	3.54	3.74	1.000	1.500
XV502SS-20	1-1/4	2	1.000	1.500	7.00	1/4-20 UNC	9.00	4.00	4.55	1.250	2.000
XV502SS-24	1-1/2	2-3/8	1.000	1.500	7.00	1/4-20 UNC	7.19	4.38	5.42	1.500	2.000
XV502SS-32	2	3	1.000	1.500	7.00	1/4-20 UNC	9.75	5.50	5.68	2.000	2.000

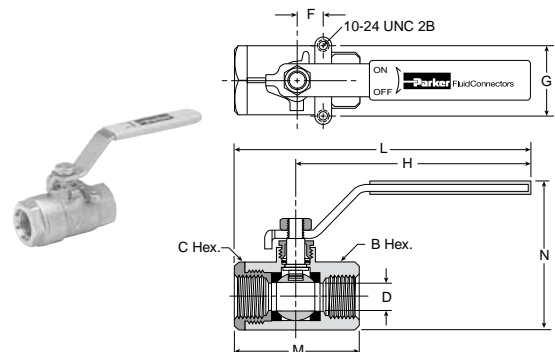

E
Product Index
Ball Valves
Stainless Steel Ball Valves
Plug Valves

Features

Materials of Construction	
Fitting:	Brass
Nut:	Brass
Ferrule:	Brass

Nomenclature	
Example: PV607-2-options	Attribute:
PV	Plug valve
607	Male to male
2	1/8" Male
N (not shown)	Neoprene (brown)
V (not shown)	Fluorocarbon (red)

Specifications	
Pressure Range	Up to 250 PSI
Temperature Range	-40° to +175°F

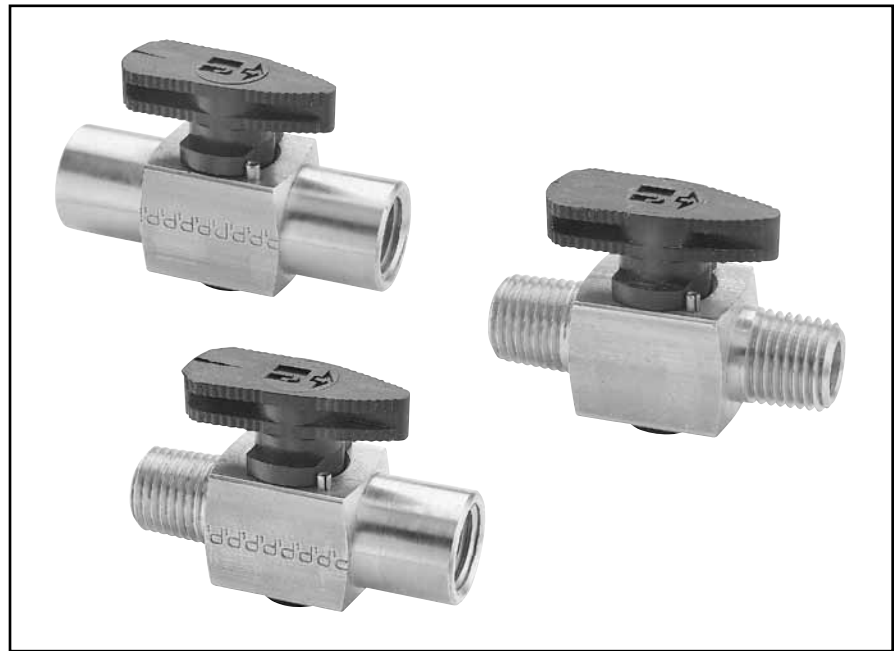

Compact design features internal nitrile seals and a one-piece extruded brass body, offering compatibility with a wide range of media. The one-piece stem / handle combination is constructed of glass reinforced acetal copolymer. Parker plug valves feature 1/4 turn shutoff allowing for ease of operation. All plug valves are 100% leak tested and are certified to be leak free to one SCCM.

Installation Instructions

To assure sealability and reliable performance, the valve must be installed so that the flow media travels in the direction of the arrow on the valve handle.

Valve Components

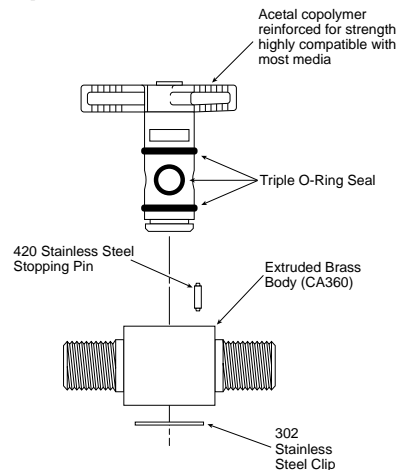

E

Product Index

Ball Valves

Stainless Steel Ball Valves

Plug Valves

Part Numbers

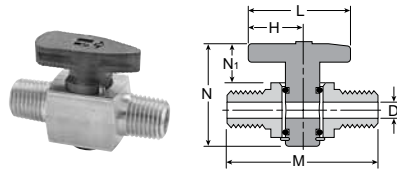

Male Pipe to Male Pipe Plug Valve PV607

Part No.	Pipe Thread	H	L	M	N	N1	Flow Dia. D
PV607-2	1/8	.67	1.34	1.66	1.38	.51	.200
PV607-4	1/4	.67	1.34	2.02	1.38	.51	.200

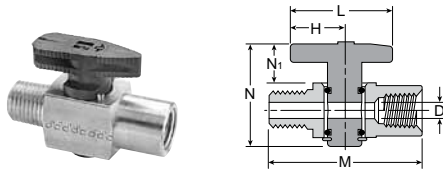

Female Pipe to Male Pipe Plug Valve PV608

Part No.	Pipe Thread	H	L	M	N	N1	Flow Dia. D
PV608-2	1/8	.67	1.34	1.67	1.38	.51	.200
PV608-4	1/4	.67	1.34	2.06	1.38	.51	.200

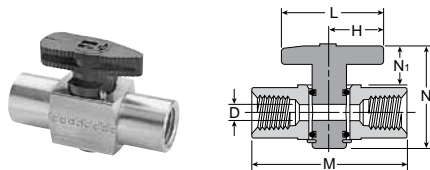

Female Pipe to Female Pipe Plug Valve PV609

Part No.	Pipe Thread	H	L	M	N	N1	Flow Dia. D
PV609-2	1/8	.67	1.34	1.68	1.38	.51	.200
PV609-4	1/4	.67	1.34	2.10	1.38	.51	.200

E

Product Index

Ball Valves

Stainless Steel Ball Valves

Plug Valves

Drain Cock Nomenclature	
Example: DC604-2	Attribute:
DC	Drain Cock
604	External Seat
2	1/8 Pipe Thread

Ground Plug Shutoff Nomenclature	
Example: V204F-4-2	Attribute:
V	Valve
204	Flared to Male Pipe
F	Flared
4	1/4 Tube O.D.
2	1/8 Pipe Thread

Specifications	
Ground plug shutoff:	30 PSI
Drain Cocks	150 PSI
Temperature Ranges:	See specific part number for temperature range
Operating Fluid:	Air, water, gas and certain other fluids.
Note:	Lubricant may not be compatible with some fluids, contact factory for special fluid requirements



Drain cocks are manufactured in both external and internal seats. Ground plug shutoffs are manufactured from castings or forged bodies for extra strength. Hand tightening provides a metal - to - metal seal.



Product Index

Ball Valves

Stainless Steel Ball Valves

Plug Valves

Internal Seal Drain Cock DC602

Temperature Range: -65° to +250°F

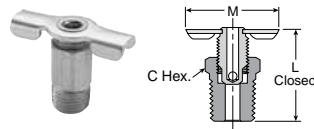

Part No.	Pipe Thread	C Hex	L	M
DC602-2	1/8	13/32	.92	1.25
DC602-4	1/4	9/16	.94	1.25

External Seal Drain Cock DC604

Temperature Range: -25° to +250°F

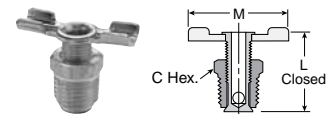

Part No.	Pipe Thread	C Hex	L	M
DC604-2*	1/8	7/16	.85	1.25
DC604-4	1/4	9/16	1.00	1.38
DC604-6*	3/8	11/16	1.22	1.68

*When assembled handle wings are down facing