

Industrial Piping Systems



Single Wall Piping System



Double Wall Piping System



Chem Proline® Single Wall Piping • Chem Prolok™ Double Wall Piping Systems

Another
Corrosion
Problem
Solved.™



Certified to
NSF/ANSI 61-G



www.asahi-america.com

Chemical Piping Solutions

Asahi/America in cooperation with our partner AGRU of Austria introduces Chem Proline® and Chem Prolok™, the most advanced PE (Polyethylene) chemical service piping systems on the market. Chem Proline® and Chem Prolok™ are made from the latest evolution PE resin material - designed to handle the most aggressive and corrosive chemical applications.



Chemical Piping System

Chem Proline® - Single wall pipe, fittings and valves.



Chem Prolok™ - Double wall pipe, fittings and leak detection.

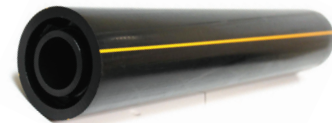

Specialty Fittings

The standard fitting range is complimented by a wide variety of specialty fittings which are machined by Asahi/America from Chem Proline® PE bar and sheet stock.



Joining Methods

Chem Proline® is joined primarily with socket and butt fusion, electrofusion is also available where needed. Chem Prolok™ is joined with simultaneous butt fusion. These fusion joining methods are the most integrous joining systems available in all thermoplastic piping. Mechanical joints such as flanges, unions and threaded adapters are also available.

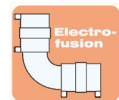
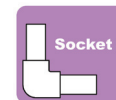

Chemical Feed/Transfer Skids

Conventional PVC, C-PVC or metal piping on skids utilize threaded connections to integrate necessary process equipment and controls into the system. Chem Proline® offers a completely threadless solution which eliminates potential leak paths, making your system more robust than your competitors.



Custom Fabrication

We offer a wide variety of manufacturing capabilities for custom products including precision machining, system fabrication, final assembly, and engineering design. Our capabilities include valve boxes, headers, vessels, quills, assemblies and trays.



Features & Benefits

- Excellent chemical and corrosion resistance
- Available from stock in sizes 20 - 315mm (1/2" to 12")
- Fast installation, low cost of ownership
- UV resistant black
- NSF 61-G certified
- Above or below ground installation



Material Properties

Asahi/America's Chem Proline® shows no reduction in installed quality with high concentrations of sodium hypochlorite

- Superior stress cracking and abrasion resistance
- High creep rupture strength
- High pressure load resistance of 150psi at 68°F
- Wide temperature range (between -22°F - 140°F)
- Exceptional weldability
- High resistance to chemical attack
- High impact resistance and ductility

Chemical Resistance of Chem Proline®

To enable the use of Chem Proline® in new application areas, research by raw material suppliers has focused in the past few years on a material property that is generally known as "resistance to slow crack growth" or "stress crack resistance". By means of process optimization in raw material production and special co-polymerization methods, the raw material suppliers have developed Chem Proline® featuring outstanding stress crack resistance.

The main technical advantage of Chem Proline® is the significantly higher resistance to slow crack growth. This is expressed by the requirements for the FNCT (full notch creep test) ISO 16770, which is greater than 8760 hours for Chem Proline® in comparison to only 300 hours for PE 100 / PE 4710 resin.

Chemical Name	Chemical Symbol	Common Uses	Typical Concentrations / Conditions	Chem Proline® Pipe Resistance	Chem Proline® Valve	Special Considerations
Aqueous Ammonia	NH ₄ OH	Biocide Chloramination	19%	Resistant	PVC/EPDM	-
Sodium Hypochlorite (Bleach)	NaOCl	Biocide	up to 25%	Resistant	PVC/FKM	Vented Ball Valves
Sodium Hydroxide (Caustic)	NaOH	pH Adj./Corrosion Control	50%	Resistant	PVC/EPDM	-
Chlorine Gas - In Water	HClO	Biocide	< 3,500 ppm	Resistant	PVC/EPDM	-
Hydrochloric Acid	HCl	pH Adjustment	37%	Resistant	PVC/FKM	Vented Ball Valves
Hydrofluosilicic Acid	H ₂ SiF ₆	Fluoridation	50%	Resistant	PVC/EPDM	-
Hydrogen Peroxide	H ₂ O ₂	Oxidant	100%	Resistant	PVDF/PTFE	Diaphragm Valves
Peracetic Acid	CH ₃ CO ₃ H	Biocide	12%	Resistant	PVC/EPDM	-
Sulfuric Acid	H ₂ SO ₄	Raw Water Treatment & pH Adjustment	Up to 85%	Resistant	PVC/FKM	-

This data is for reference only. For specific application references, please contact Asahi/America's Engineering Department.



Full Notch Creep Test (FNCT)

PE Class	Minimum Standard FNCT
PE 63	30 Hours
PE 80	100 Hours
PE 100	300 Hours
PE 100-RC	8,760 Hours (1 year)

PE Class	Average Results FNCT Rupture time in hours
PE 63	7.5 Hours (2 samples)
PE 80	114 Hours (3 samples)
PE 100	533 Hours (5 samples)
Chem Proline®	14,648 Hours (2 samples)

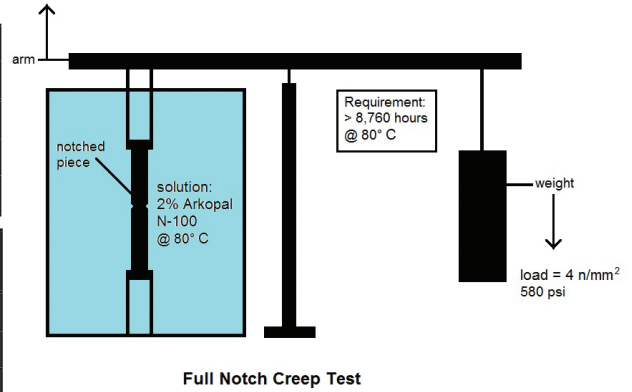

Chem Proline® vs other Piping Systems

Chem Proline® by Asahi/America is manufactured under special license by AGRU of Austria. Chem Proline® is made from a proprietary polyethylene resin, which provides the highest resistance to chemical attack.

Chem Proline® vs PE 4710

- Over 800% more resistant to chemical crack propagation
- 40 times more stress crack resistant
- Requires no special bedding in buried applications
- Able to withstand point loads

Chem Proline® vs FRP Pipe

- Better impact resistance
- Much shorter joint cure times

Chem Proline® vs Metal Pipe

- Fusion joints are as strong as the pipe
- Non-metallic, no rust or corrosion

Chem Proline® vs PVC/C-PVC

- No glued or threaded joints
- Greater ductility
- Reduced installation time, short cure times

Chem Proline® vs Plastic Lined Steel Pipe

- No flange/mechanical joints
- No metal corrosion issues

Supply Range

Chem Proline®

Pipe and Fittings

- 20 - 315mm (1/2" - 12") 150psi

Valves

- Type-21 Ball Valves: 20 - 110mm (1/2" - 4")
- Type-57 Butterfly Valves: 50 - 315mm (1-1/2" - 12")
- Type-14 Diaphragm Valves: 20 - 250mm (1/2" - 10")
- Ball Check Valves: 20 - 110mm (1/2" - 4")
- Regulator Valves, Relief Valves, Gauge Guards

Welding Methods

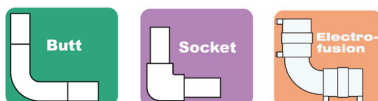

Chem Prolok™

Pipe and Fittings

- 1"x3" through 12"x16" 150psi x 45psi (Containment)

Leak Detection

- Complete range of leak detection available

Welding Methods



Short Specifications



Visit our web site
for complete
specifications.



Chem Proline® pipe, molded fittings, valve end connectors and fabricated components shall be made of black polyethylene (PE) resin with a cell classification of PE445584C and shall conform to the material requirements according to PAS 1075. Valves shall be PVC or C-PVC and shall be joined to the piping system by either a Chem Proline® PE end connector or an ANSI 150# flanged connection. System shall be SDR rated to 150psi at 68°F for chemical service. System shall be joined by socket fusion, butt fusion and/or electrofusion.



Chem Prolok™ double contained pipe and fittings shall be made of black polyethylene (PE) resin with a cell classification of PE445584C and shall conform to the material requirements according to PAS 1075. Primary pipe shall be SDR rated to 150psi at 68°F. Secondary pipe shall be SDR11 rated to 150psi or SDR33 rated to 45psi at 68°F. System shall be joined by simultaneous butt fusion.

Please visit our web site: www.asahi-america.com for full detailed sample specifications.

Applications



Ideal Applications

- pH range 1-14
- Bleach
(sodium hypochlorite)
- Process Chemical
& Waste
- Caustic
- Acids
- Industrial Water
- Horizontal
Directional Drilling



Basic Design and Installation Considerations

Thermofusion

Properly trained installers are critical to overall system performance. Asahi/America recommends plastic pipe contractors maintain certifications according to DVS thermofusion guidelines. Asahi/America is proud to offer job site training according to DVS guidelines.

Training should be conducted a maximum of 1 week prior to beginning of installation by authorized Asahi personnel.

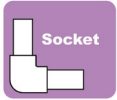

Socket Fusion

The illustration to the right shows socket fusion steps:

- **Melting the Pipe and Fitting:** After peeling the end of the pipe, insert the pipe and the fitting onto the heater bushings simultaneously and hold for the heating time.

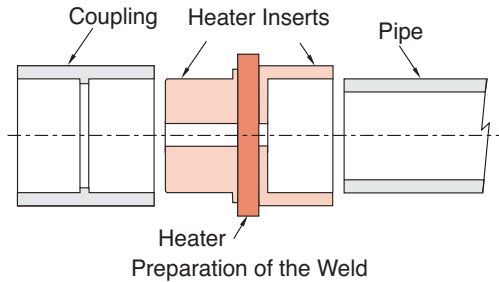

- **Making the Joint:** After the heating time, pull the pipe and fitting off the heater bushings and immediately insert the pipe into the socket of the fitting up to the socket depth.

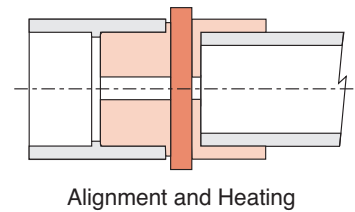

- **Curing:** After insuring the pipe has been inserted properly, allow the new fitted joint to cool for the specified time before moving the joint.

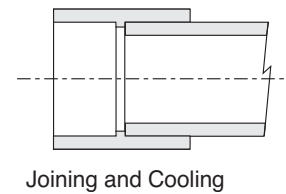

Welding Equipment



Hand Held Socket

20 - 63mm (1/2" - 2")



Bench Socket

20 - 110mm (1/2" - 4")

Socket Fusion Cure Times:

Size		Chem Proline® CURE TIME	PVC/C-PVC Solvent Cement CURE TIME*
inch	mm		
1/2	20	2 minutes	6 – 48 hrs.
3/4	25	2 minutes	6 – 48 hrs.
1	32	4 minutes	6 – 48 hrs.
1-1/2	50	4 minutes	12 – 96 hrs.
2	63	6 minutes	12 – 96 hrs.
3	90	6 minutes	1 – 8 days
4	110	8 minutes	1 – 8 days

Note: For exact parameters, please consult equipment manuals.

* Source - ASTM-D2855



Basic Design and Installation Considerations



Butt Fusion

Butt fusion thermally bonds pipe and components by heating the face of the components. Once elevated to the material specific melting temperatures the component faces are pressed against each other.

Bench top welding tools are capable of welding up to the maximum size available in the piping system. Welding equipment up to 160mm (6") can often be used in hard to reach areas like pipe rafters.

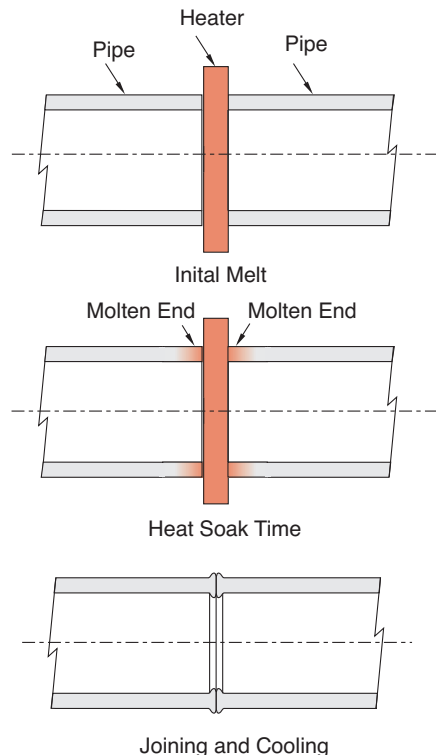

Welding Equipment

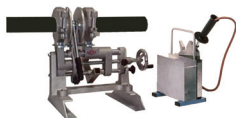

Miniplast

20-110mm (1/2" - 4")



Maxiplast

50-160mm (1-1/2" - 6")



Electrofusion

Electrofusion thermally bonds pipe components by heating a section of the component and the electrofusion coupling.

Electrofusion uses electricity to heat and imbedded copper wire through resistance. Chem Proline's imbedded wire is never exposed to media being transported.

Fittings are available up to 315mm (12") and require the use of electrical control device which regulates voltage and current.

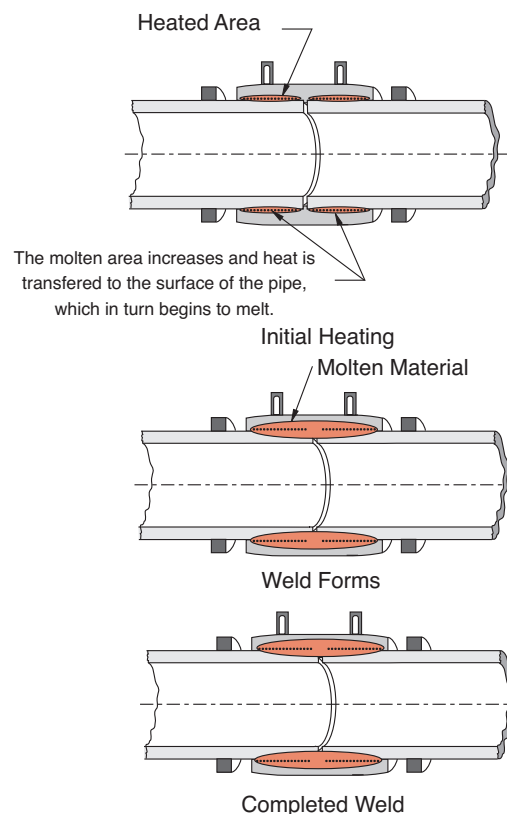

Welding Equipment



Polymatic

All sizes



Basic Design and Installation Considerations

Pressure Rating:

The design stress is based on the hydrostatic design basis(HDB) of the material.

$$S = (HDB) / F$$

where F is a safety factor.

HDB is determined from testing the material according to ASTM D 2837 to develop a stress regression curve of the material over time. By testing and extrapolating out to a certain time, the actual hoop stress of the material can be determined.

Permissible operating pressure for Chem Proline® piping system is 150psi but must be reduced at elevated temperatures. The chart below provides a recommended reduction factor based upon operating temperature.

Permissible Operating Pressure:

Temperature °F °C		Correction Factor	Pressure Rating
68	20	1.00	150psi
86	30	0.88	130psi
104	40	0.79	120psi
140	60	0.65	100psi

Designing for Expansion and Contraction:

Chem Proline® and Chem Prolok™ pipe expand and contract as the material temperature fluctuates. This must be managed properly to prevent failure and to maintain aesthetics. This is done by using proper pipe clips and restraints and/or by employing offsets and loops. The system should be installed within the limits of the material (maximum allowable stress) based on the conditions of service. Asahi/America’s pipe engineering group can assist the designer with calculations in order to facilitate a proper installation.

Aesthetics is always an important factor in designing a thermoplastic piping system. Chem Proline® material expands and contracts approximately 12 times that of steel pipe. A properly designed and installed Chem Proline® system will move within the limits of the design. This should be expected and not be perceived as a problem.

Chem Proline® material has excellent physical and mechanical properties especially ductility. The force (end load) generated by the material as a result of temperature induced expansion or contraction is relatively low as compared to metal piping systems. As such, there are several methods available to handle expansion and contraction. These methods all involve using predetermined fixed points (anchors) and allowing the pipe to either move or be restrained (all within limits) between the fixed points.



Basic Design and Installation Considerations

Change of Length Due to Thermal Expansion:

Change in length due to thermal expansion must be considered if the temperatures during installation and operation are different.

Plastic has the property of expanding under heat.

The calculation of the change in length of Chem Proline® pipes is based on the following formula:

$$\Delta L = \alpha \cdot \Delta T \cdot L$$

ΔL = change in length due to the temp. change [mm]

α = linear expansion coefficient [mm/m/K]

ΔT = difference in temperature [K]

L = pipe length [m]

The length change results from the difference between the installation temperature and the maximum and minimum pipe wall temperature (installation, operation, shut-down).

Calculation of minimum straight length (following DVS 2210, part 1)

Changes in length are caused by a changing operating temperature.

Axial movement compensation should be provided outside of the installed pipes.

In many cases, the changes in the direction of the pipe layout can be used to compensate changes in the length.

Prestressing method – Installation

For this method, it is required to enter $\Delta L/2$ to calculate the minimum straight length as part of the change in length as compensated by prestressing by $\Delta L/2$.

This means that, in practice, the bent side is already prestressed by half of the change in the length $\Delta L/2$.

Advantages of the prestressing method:

- The minimum straight length can be reduced
- Perfect installation during operation, as the expansion is hardly visible

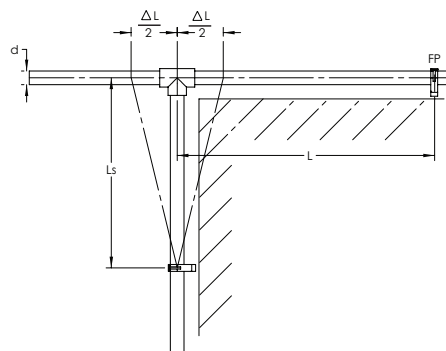
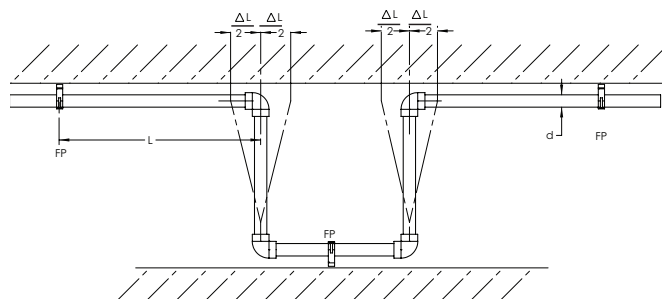
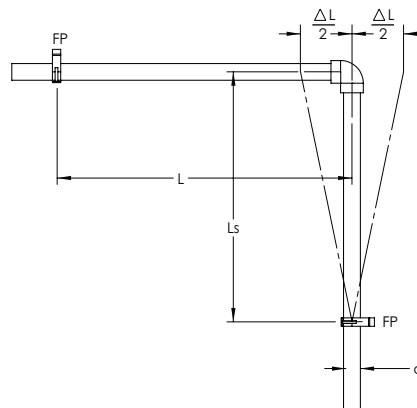

The minimum straight length is based on the following:

$$L_s = C \cdot \sqrt{d_a \cdot \Delta L}$$

- L_s = minimum straight length [mm]
- d_a = pipe outside diameter [mm]
- ΔL = change in length [mm]
- C = material coefficient $C=26$ (PE)



Basic Design and Installation Considerations

Anchors and Supports:

Chem Proline® must be properly installed in order to provide worry free use. Support spacing is calculated by determining the material specific properties, ambient temperature, media temperature and specific gravity. The chart below shows recommended support spacing for Chem Proline®. It is also possible to continually support the system in a pipe tray and/or V-channel.

Support Spacing (feet):

Size		68 °F	86 °F	104 °F	122 °F	140 °F	158 °F	176 °F
inch	mm							
1/2	20	3	2.5	2.5	2	2	2	2
3/4	25	3	3	2.5	2.5	2.5	2.5	2
1	32	3.5	3	3	3	3	2.5	2.5
1-1/2	50	4	3.5	3	3	3	3	3
2	63	4.5	4	4	3.5	3	3	3
3	90	5.5	5	4	4	4	3.5	3.5
4	110	6	5	5	4	4	4	4
6	160	7	6	6	5	5	4.5	4.5
8	200	7.5	7	6	6	5.5	5	5
10	250	8.5	7.5	7	6.5	6	6	5.5
12	315	9.5	8.5	8	7	7	6.5	6

Burial Considerations:

The resin system used for Chem Proline® and Chem Prolok™ is extremely crack resistant. This provides a unique advantage when it comes to burying methods.

Typically, plastic piping should be protected from point loads like rocks in the ground by digging an extra wide trench and backfilling with sand to protect the pipe from point loads. This is not necessary with the Chem Proline® material.

Chem Proline® and Chem Prolok™ provide additional benefits through advanced installation methods such as horizontal directional drilling (HDD) or sand bed free trench installations.

Chem Proline® exhibits exceptional resistance to slow crack growth and crack propagation. Which allows installers to reuse excavated materials for covering the trench as well as reducing the amount of ground preparation required before laying the system.

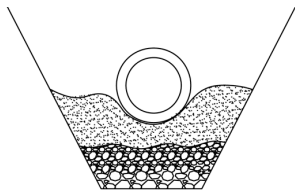

Typical Plastic Pipe Prep.

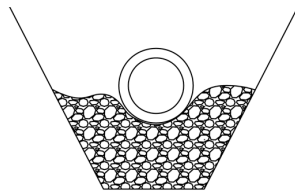

Chem Proline® Pipe Prep.

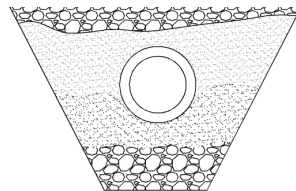

Typical Plastic Pipe Burial

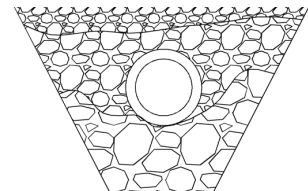

Chem Proline® Pipe Burial



Basic Design and Installation Considerations

Abrasion Resistance:

In principle, thermoplastics are better suited for the conveying of slurry than available alternatives such as concrete pipe or steel. The Darmstädter method is a standard test procedure to determine the abrasion resistance of piping components.

According to this method, a 3 foot length of pipe is cut in half to form a trough. The trough is tilted at a frequency of 0.18 Hz.

The chart below illustrates Chem Proline's superior abrasion resistant characteristics.

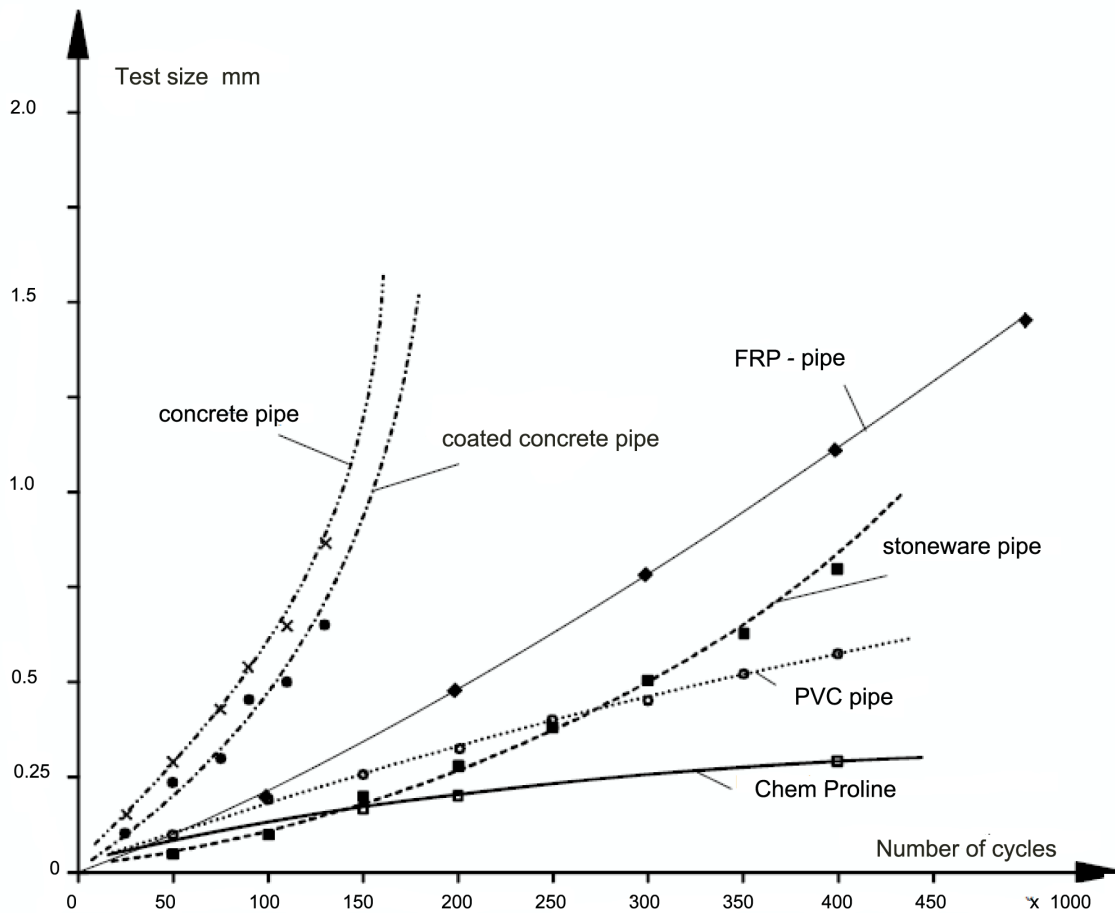

Another Corrosion Problem Solved.TM

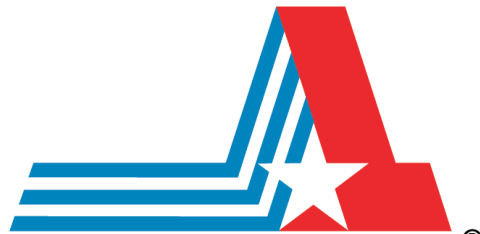

ASAHI/AMERICA[®]

35 Green St., Malden, MA 02148

Tel: 800-343-3618; 781-321-5409

Direct Sales: East (800) 232-7244
Central (800) 442-7244
West (800) 282-7244

Fax: 800-426-7058

www.asahi-america.com

asahi@asahi-america.com

