



LOCKS AND CATCHES

- Door Catches
- Locking Systems
- Door Locks

**Locks and Catches**  
Products in this section



**Magnetic Catches**

- Simple latch for sliding and swing doors
- Some catches with variable holding force

📄279

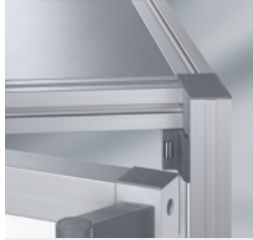

**Magnetic Door Stop**

- Combination of Door Stop and Magnetic Catch
- Lead-in wedge, Limit Stop and buffer in one

📄280



**Ball Latch**

- Low-wear door catch
- Holds firm with an audible click

📄281



**Catch Mounting Bracket**

- Universal fastening for Magnetic Latches and Ball Latches
- Suitable for all modular dimensions

📄282



**Door Latch**

- Construction height of just 12 mm for narrow door gap
- Simple and effective door closure

📄283

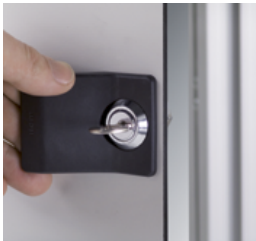

**Locking Systems with escutcheons/grips**

- Lock and grip can be combined in one unit
- For frameless panel elements

📄284



**Door Lock 6-8 Zn**

- Particularly stable Lock System
- Fitted on the outside, to the surround and door frames

📄287



**Door Locks 8**

- A simple means of securing sliding and swing doors
- No profile machining required

📄288



**Integrated Lock System 8**

- Can be converted from a pawl latch to a rod latch
- Locks at up to three points

📄289



**Lock System 6-8**

- Universal fastening system for right and left-handed doors
- Uses conventional mortise locks in line with DIN 18251

📄291



**Dual-Rod Mesh Lock System**

- Special mechanism to enable secure fitting to dual rod meshes
- Uses conventional mortise locks in line with DIN 18251

📄293



**Sliding-Door Pin Lock**

- Pin locks sliding doors together
- Installed directly into the panel element

📄294

9



## Magnetic Catches Magnetic Catch X

- Simple latch for sliding and swing doors
- Some catches with variable holding force
- Products from Line X also available

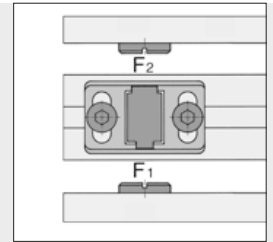
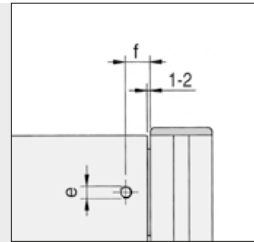
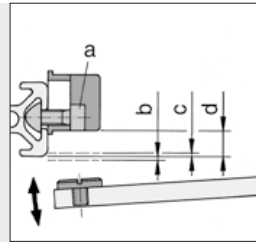

Magnetic Catches are particularly suitable for latching swing and sliding doors. Turning the Magnetic Catch through 180° enables users to choose between two different holding forces (this does not apply to Magnetic Catch X). The Magnetic Catches can be adjusted to the thickness of the panel element using the mounting slots. In conjunction with Catch Mounting Brackets, they can also be used on doors with profile frames.

	5	8	Line
a Screw DIN 912	M4x12 DIN 912	M6x20 DIN 912	M5x16 ISO 7380
b [mm]	1	-	-
c [mm]	-	1	6
d [mm]	7	14	8
e	M4	M5	M5
f [mm]	8	10	9
F1 [N]	3	10	20
F2 [N]	5	20	20

9

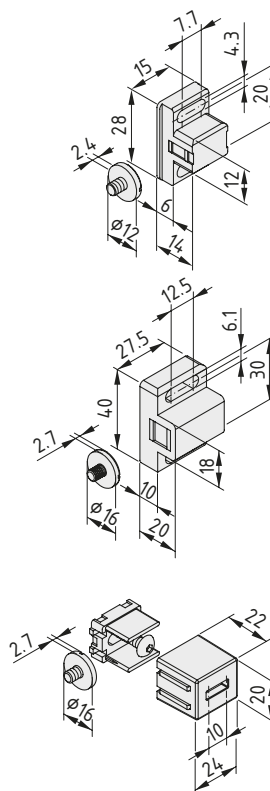

### Magnetic Catch 5



PA-GF  
Flat head screw DIN 921-M4x5, St, bright zinc-plated as holding plate  
m = 9.0 g

black, 1 pce.	0.0.391.32
grey, 1 pce.	0.0.642.28

### Magnetic Catch 8



PA-GF  
Flat head screw DIN 921-M5x6, St, bright zinc-plated as holding plate  
m = 34,0 g

black, 1 pce.	0.0.196.48
---------------	------------



### Magnetic Catch X



Housing base, die-cast zinc  
Housing cap, PA-GF, grey  
Flat head screw DIN 921-M5x6, St, bright zinc-plated as a holding plate  
Button-Head Screw ISO 7380-M5x16, St, stainless  
m = 38.0 g

1 set	0.0.601.70
-------	------------



## Magnetic Door Stop 8

- Combination of Door Stop and Magnetic Catch
- Lead-in wedge, Limit Stop and buffer in one
- Protects profile edges

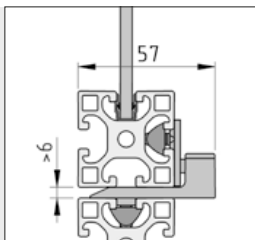

The Door Stop is fastened to a Line 8 groove in the outer frame and forms a lead-in wedge, a buffer and the limit stop (limiting the penetration depth for the modular dimension 40 mm).

Closing force  $F = 40 \text{ N}$

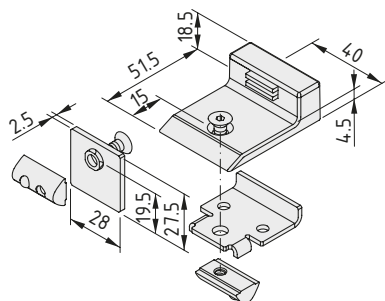

### Magnetic Door Stop 8



Housing, PA-GF  
 Insert plate, St, bright zinc-plated  
 Stop plate, St, bright zinc-plated  
 2 T-Slot Nuts V 8 St M5, bright zinc-plated  
 Countersunk Screw DIN 7991-M5x12, St, bright-zinc-plated  
 Countersunk Screw DIN 7991-M5x14, St, bright zinc-plated  
 $m = 76.0 \text{ g}$

grey, 1 set	0.0.600.73
black, 1 set	0.0.601.30



## Ball Latch

The powerful solution for virtually any type of door

- Low-wear door catch
- Holds firm with an audible click

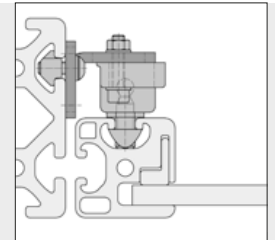
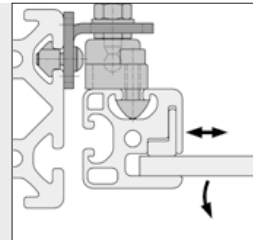
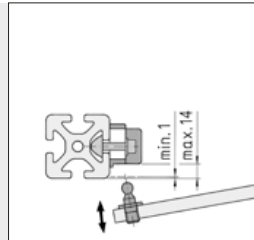
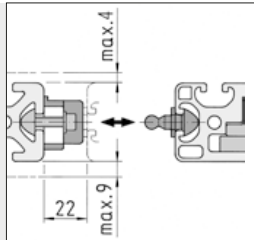
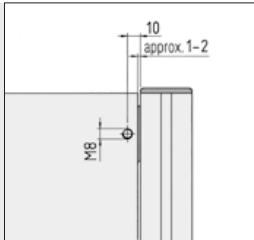

The mounting slots in the Ball Latch casing mean that the sliding door and Stand Profile can be offset. Recommended fastening to the profile: Hexagon Socket Head Cap Screw DIN 912-M5 and washer DIN 125-5.3.

Use of Catch Mounting Bracket permits narrow door gap.

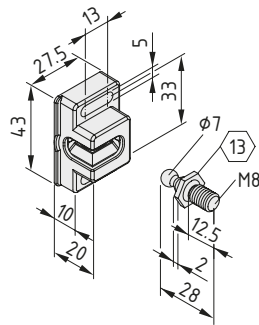

### Ball Latch 8 PA



PA-GF, black  
 Ball pin St, bright zinc-plated  
 Holding force<sub>max.</sub> = 75 N  
 m = 25.0 g

1 pce.

0.0.388.20



## Catch Mounting Bracket

- For easy fastening of Magnetic Latches and Ball Latches
- Suitable for all modular dimensions

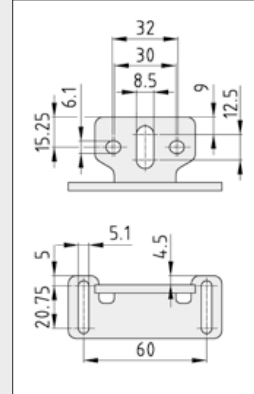
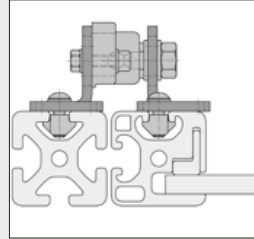
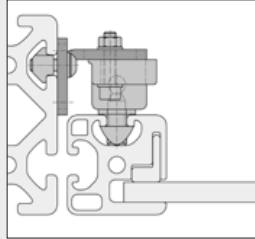
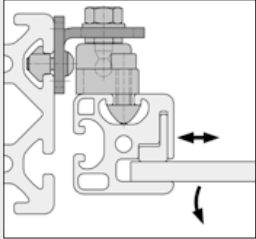

Application examples of a Catch Mounting Bracket with Ball Latch 8 for swing and sliding doors.

Depending on the particular application, either the ball pin (Ball Latch 8 PA), the holding plate (magnetic catch) or the housings of the relevant latches can be secured to the Catch Mounting Bracket.

By combining two Catch Mounting Brackets it is also possible to use latches to lock together profiles of the same size, minimising the gap between them.

If the Catch Mounting Bracket is adjusted to the extreme of the slots, it may be necessary to use an appropriate washer between it and the profile to prevent tilting.

The connection is made on the profile side using M5 screws fitted into slots. DIN 125 washers must be used.

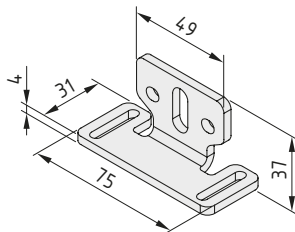

### Catch Mounting Bracket

St  
m = 88.0 g

black, 1 pce.

0.0.475.06



## Door Latch

- Construction height of just 12 mm for narrow door gap
- Holding force 40 N

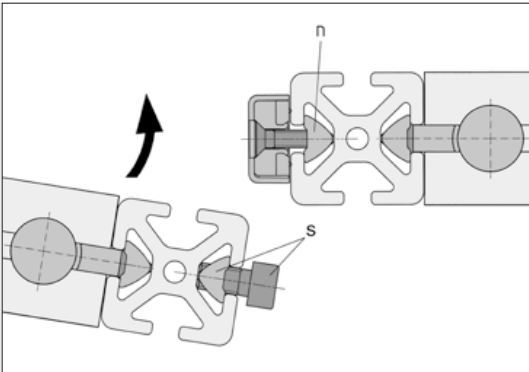

Profile	n	s
	T-Slot Nut 6 St M4	Screw DIN 912-M6x12 T-Slot Nut 6 St M6
	T-Slot Nut 8 Zn M4	Screw DIN 912-M6x14 T-Slot Nut 8 St M6

- Hexagon Socket Head Cap Screws 152
- T-Slot Nuts St 132
- T-Slot Nuts Zn 137

The Door Latch Zn can be attached to any combination of Line 6 and 8 Profiles.

The length of the Hexagon Socket Head Cap Screw (s) depends on the profile line used.

The T-Slot Nuts (n) with thread M4 for fastening the Door Latch Zn should be selected according to the profile line used.

9

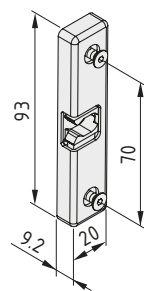

### Door Latch Zn

Die-cast zinc, bright zinc-plated  
 Cap PA-GF, black  
 2 Countersunk Screws DIN 7991-M4x16, bright zinc-plated  
 m = 66.0 g

1 set	0.0.473.62
-------	------------

## Locking Systems with Escutcheons/Grips

- Lock and grip can be combined in one unit
- For frameless panel elements
- With Cylinder or Double-Beard Lock

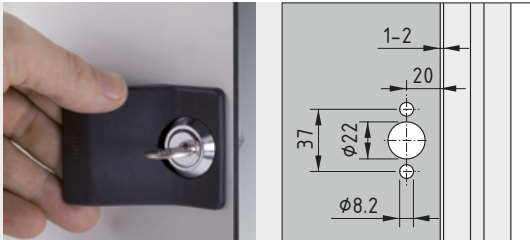

The panel element is processed for fitting the Lock System with escutcheon/grip.

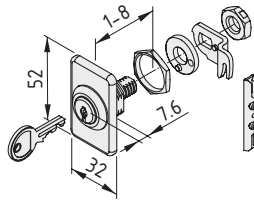

### Locking System 5, Cylinder Lock with escutcheon



Cylinder Lock, keys identical  
Key, locking bar, nab  
Notes on Use and Installation  
m = 96.0 g

right-hand application, 1 set

0.0.619.42

left-hand application, 1 set

0.0.619.43

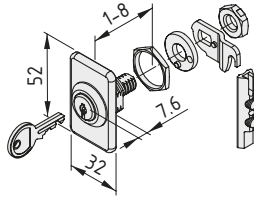

### Locking System 6, Cylinder Lock with escutcheon



Cylinder Lock, keys identical  
Key, locking bar, nab  
Notes on Use and Installation  
m = 100.0 g

right-hand application, 1 set

0.0.619.33

left-hand application, 1 set

0.0.619.35

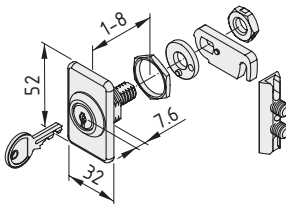

### Locking System 8, Cylinder Lock with escutcheon



Cylinder Lock, keys identical  
Key, locking bar, nab  
Notes on Use and Installation  
m = 118.0 g

right-hand application, 1 set

0.0.619.26

left-hand application, 1 set

0.0.619.63

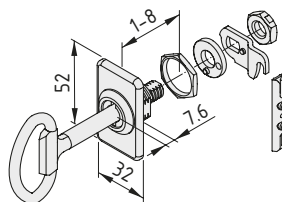

### Locking System 5, Double-Beard Lock with escutcheon



Double-beard insert  
Key, locking bar, nab  
Notes on Use and Installation  
m = 126.0 g

right-hand application, 1 set

0.0.619.50

left-hand application, 1 set

0.0.619.52



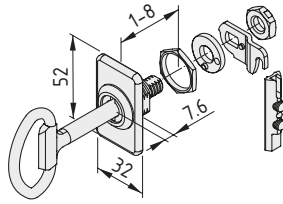

<b>Locking System 6, Double-Beard Lock with escutcheon</b>	<b>6</b>
Double-beard insert Key, locking bar, nab Notes on Use and Installation m = 130.0 g	
right-hand application, 1 set	0.0.619.38
left-hand application, 1 set	0.0.619.39

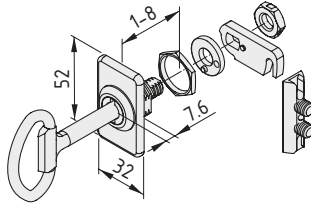

<b>Locking System 8, Double-Beard Lock with escutcheon</b>	<b>8</b>
Double-beard insert Key, locking bar, nab Notes on Use and Installation m = 148.0 g	
right-hand application, 1 set	0.0.619.27
left-hand application, 1 set	0.0.619.64

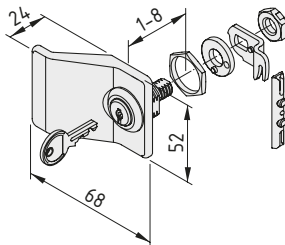

<b>Locking System 5, Cylinder Lock with grip</b>	<b>5</b>
Cylinder Lock, keys identical Key, locking bar, nab Notes on Use and Installation m = 108.0 g	
right-hand application, 1 set	0.0.619.44
left-hand application, 1 set	0.0.619.45

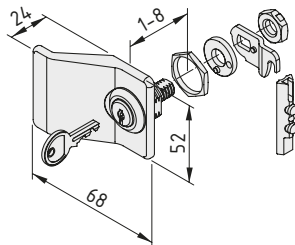

<b>Locking System 6, Cylinder Lock with grip</b>	<b>6</b>
Cylinder Lock, keys identical Key, locking bar, nab Notes on Use and Installation m = 112.0 g	
right-hand application, 1 set	0.0.619.36
left-hand application, 1 set	0.0.619.37

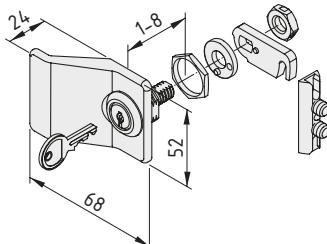

<b>Locking System 8, Cylinder Lock with grip</b>	<b>8</b>
Cylinder Lock, keys identical Key, locking bar, nab Notes on Use and Installation m = 130.0 g	
right-hand application, 1 set	0.0.619.28
left-hand application, 1 set	0.0.619.65

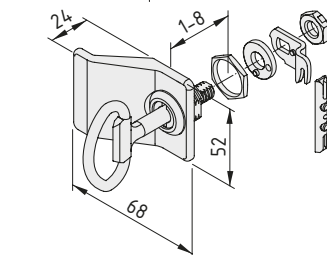

<b>Locking System 5, Double-Beard Lock with grip</b>	<b>5</b>
Double-beard insert Key, locking bar, nab Notes on Use and Installation m = 138.0 g	
right-hand application, 1 set	0.0.619.55
left-hand application, 1 set	0.0.619.57



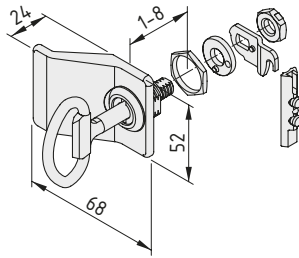

**Locking System 6, Double-Beard Lock with grip**



Double-beard insert  
Key, locking bar, nab  
Notes on Use and Installation  
m = 142.0 g

right-hand application, 1 set	0.0.619.40
left-hand application, 1 set	0.0.619.41

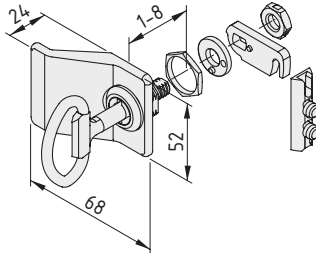

**Locking System 8, Double-Beard Lock with grip**



Double-beard insert  
Key, locking bar, nab  
Notes on Use and Installation  
m = 160.0 g

right-hand application, 1 set	0.0.619.29
left-hand application, 1 set	0.0.619.66



## Door Lock 6-8 Zn

- Particularly stable Lock System
- Fitted on the outside, to the surround and door frames



Door Lock 6-8 Zn is a lock system for swing doors that can be screwed onto door frames and fixed door frames constructed from Line 6 or 8 Profiles.

Fitted with an ergonomic swivel handle, Door Lock 6-8 Zn is the perfect solution for doors that are opened and closed frequently. The spring-loaded latch engages in the lock case secured to the outer frame.

An integrated cylinder lock can be used to lock the latch in position.

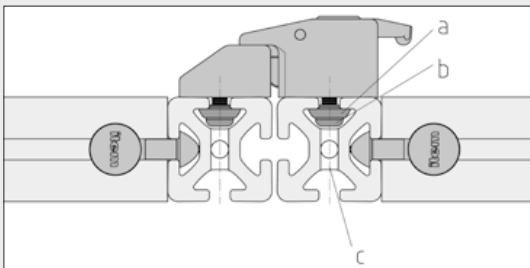

	6	8
a	Washer DIN 125-6.4	Locating Washer 8 D6 (0.0.482.12)
b	Button Head Screw DIN ISO 7380-M6x10 (8.0.002.37)	Button Head Screw DIN ISO 7380-M6x16 (8.0.000.63)
c	∅ 6	∅ 7

Door Lock 6-8 Zn screwed to profile door frame and fixed outer frame

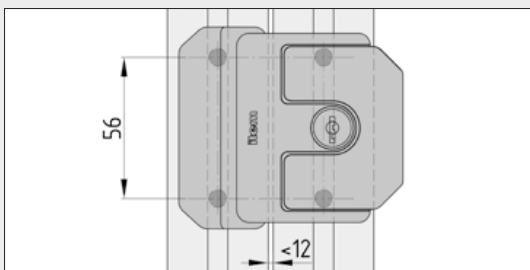

Profile bore grids for attaching Door Lock 6-8 Zn

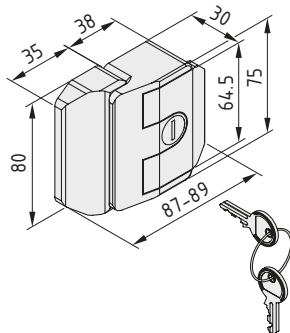

### Door Lock 6-8 Zn



Cylinder lock (all keys identical)  
 Lock housing, die-cast zinc, black  
 Lock case, die-cast zinc, black  
 4 Square nut inserts M6, St, bright zinc-plated  
 m = 560.0 g

1 pce.

0.0.488.45



## Door Locks 8

- A simple means of securing sliding and swing doors
- No profile machining required
- With Cylinder or Double-Beard Lock

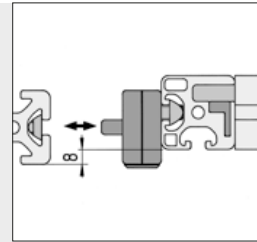
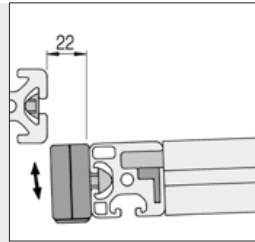
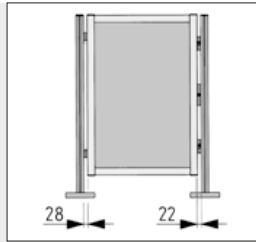
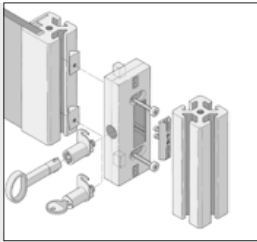

Application example for door construction:  
Clearance on left 28 mm with Hinges 8 40 Zn and on right 22 mm with Door Rabbets 8, in combination with Door Lock 8.

Depending on the application, the anti-torsion blocks in the housing can be repositioned.  
The nabs have two different mounting positions for sliding and swing doors.

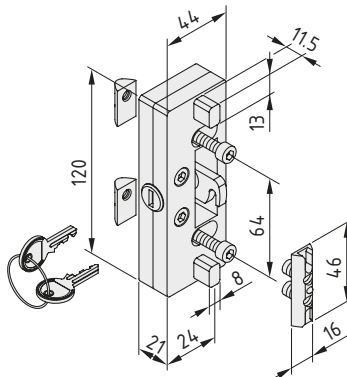

### Door Lock 8 with Cylinder Lock



Cylinder lock (all keys identical)  
Housing and anti-torsion blocks, PA-GF, black  
2 Hexagon Socket Head Cap Screws DIN 912-M6x25, St, bright zinc-plated  
2 T-Slot Nuts 8 St M6, bright zinc-plated  
Key, locking bar, nab  
m = 204.0 g

1 set

0.0.265.08

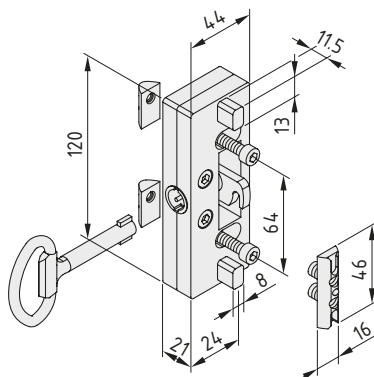

### Door Lock 8 with Double-Beard Insert



Double-beard insert  
Housing and anti-torsion blocks, PA-GF, black  
2 Hexagon Socket Head Cap Screws DIN 912-M6x25, St, bright zinc-plated  
2 T-Slot Nuts 8 St M6, bright zinc-plated  
Key, locking bar, nab  
m = 237.0 g

1 set

0.0.265.09



## Integrated Lock System 8

From a pawl latch to a rod latch

- Locking system in a Line 8 groove
- Locks at up to three points
- Installed directly in the door profile
- Can be operated from both sides

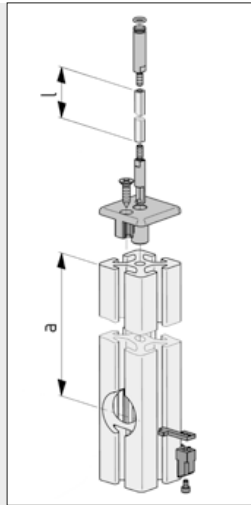
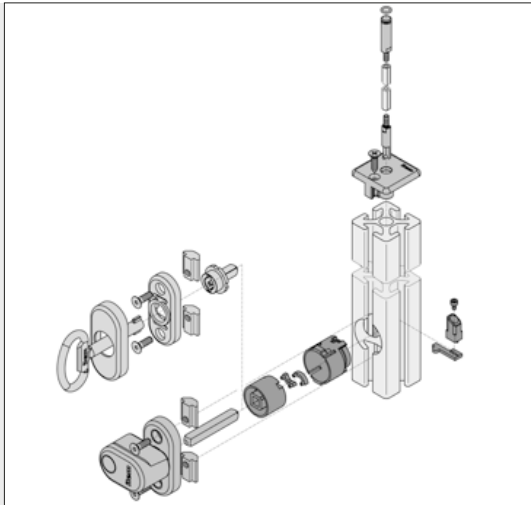

$l = a - 60 \text{ mm}$



9

The basic version of the door lock with Integrated Lock System 8 consists of Rotating Pawl Latch 8 and at least one Door Knob. A Rod Latch 8 is required for the rod for both the upper and lower ends of the door.

A countersink with a diameter of 30 mm must be drilled into the door profile for holding the Integrated Lock System. A commercially available countersinking drill (3-cutter with  $\varnothing 11 \text{ mm}$  guide pin or larger) or Step Drill, Universal Connection 12 is required for this purpose. The  $\varnothing 30 \text{ mm}$  countersink must be 25 mm deep.

The pawl latch engages into the Profile 8 groove of the door frame adjacent.

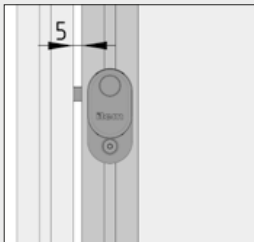

The gap between the door profile and the lateral door frame must not exceed 5 mm.



The rods of the Rod Latches move out of the core bore in the door profile and engage in the Profile 8 groove of the door frame profile adjacent.

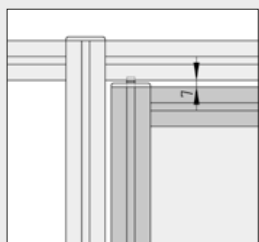

The gap between the door profile and the upper door frame must not exceed 7 mm.

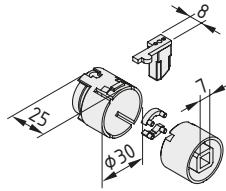

**Rotating Pawl Latch 8**



Pawl, die-cast zinc, bright zinc-plated  
 2 alternating stops, die-cast zinc, bright zinc-plated  
 Crank, die-cast zinc, bright zinc-plated  
 Connecting plate, St  
 Glide bush, POM, black  
 Cap Screw DIN 912-M3x5, St, bright zinc-plated  
 Notes on Use and Installation  
 m = 50.0 g

1 set

0.0.476.96

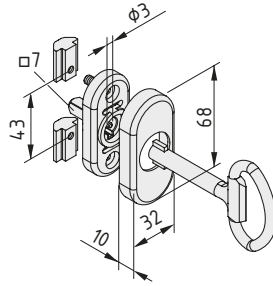

**Double-Bear Insert**



Double-beard key insert, PA-GF, black  
 Double-beard key, GD-Zn, bright zinc-plated  
 2 T-Slot Nuts 8 Al M5  
 2 Countersunk Screws DIN 7991-M5x16, St, bright zinc-plated  
 Lock body, POM, black  
 Lock body cover, PA, black  
 m = 80.0 g

1 set

0.0.486.48

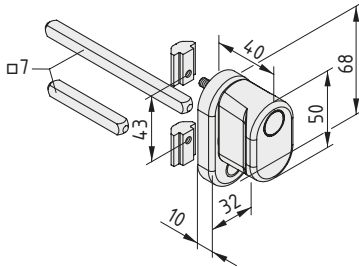

**Door Knob**



Door Knob, PA, black  
 Square pin 56 mm long, St, bright zinc-plated  
 Square pin 112 mm long, St, bright zinc-plated  
 2 T-Slot Nuts 8 Al M5  
 2 Countersunk Screws DIN 7991-M5x16, St, bright zinc-plated  
 m = 128.0 g

1 set

0.0.486.79

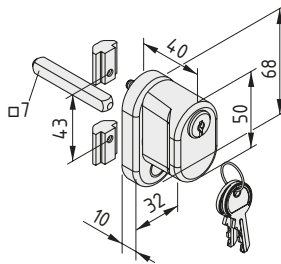

**Door Knob, Lockable**



Door Knob, PA, black, with lock insert  
 2 keys  
 Square pin 56 mm long, St, bright zinc-plated  
 2 T-Slot Nuts 8 Al M5  
 2 Countersunk Screws DIN 7991-M5x16, St, bright zinc-plated  
 m = 131.0 g

1 set

0.0.486.80

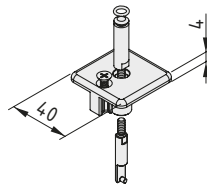

**Rod Latch 8**



Cap, PA-GF, black  
 Locking pin, St, stainless  
 Rod actuator pin, St  
 O-ring DIN 3771 5.5x1.5, NBR, black  
 Self-tapping screw DIN 7982-4.2x16, St, black  
 m = 30.0 g

1 set

0.0.476.98

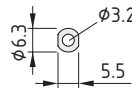

**Tube D6.3x1.6 5.5 A/F**



Al, anodized  
 m = 58 g/m

natural, cut-off max. 2000 mm

0.0.476.72

natural, 1 pce., length 2000 mm

0.0.454.36



## Lock System 6-8

- Universal fastening system for right and left-handed doors
- Uses conventional mortise locks in line with DIN 18251
- Concealed screws prevent unauthorised disassembly

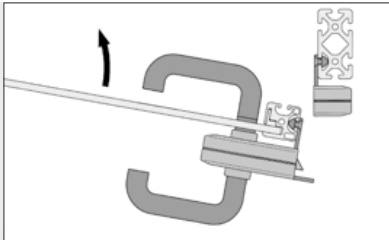

Swing door with inner-mounted lock, stop provided by the lock housing rabbet.

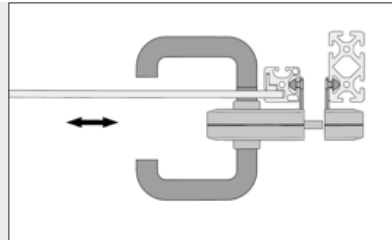

Lock System 6-8 fitted to a sliding door.

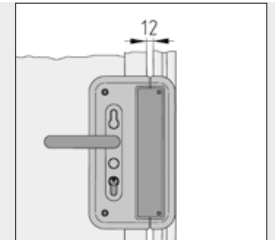
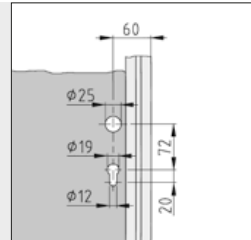

The door gap does not depend on the profile line used.

The panel element may need to be drilled for fitting door handles and standard cylinder locks. The lock housing contains the preformed openings for the holes. The distance to the edge of the door determines the position of the through holes in the panel element which are required for the door handle and profile cylinder.

9

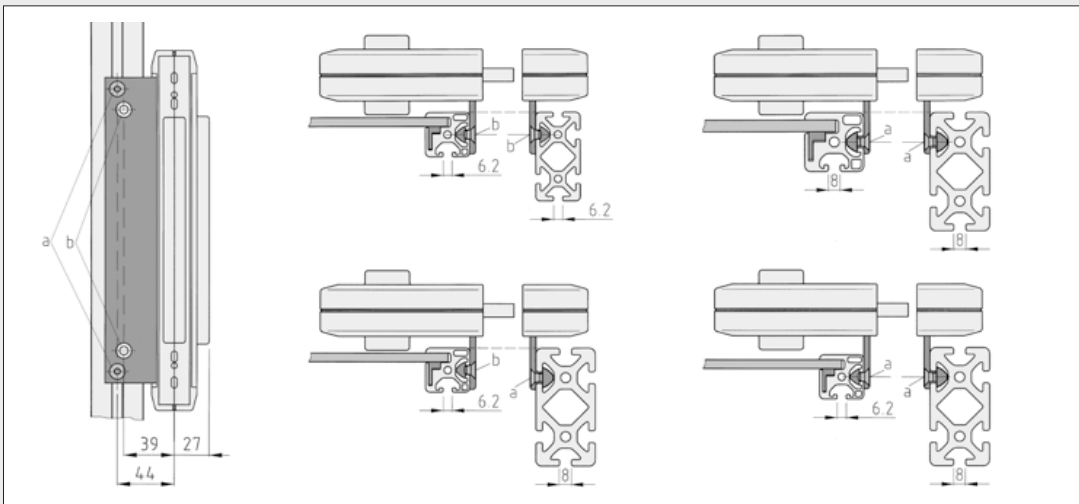

Depending on the thickness of the panel element and frame profile used, it may be necessary to select a longer standard profile cylinder than the one in this catalogue (0.0.458.42).

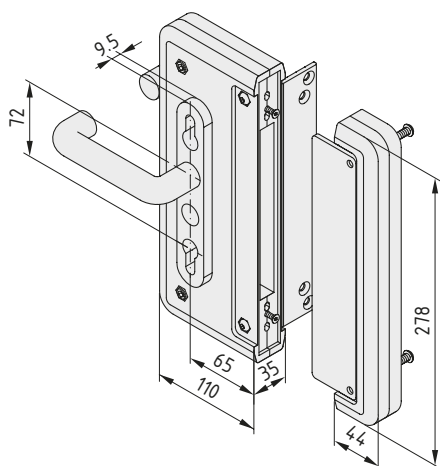

**Lock System 6-8**



Lock housing, PA-GF, black  
 Lock case, PA-GF, black with nab, St  
 Lock housing rabbet, St, black  
 2 angle brackets, Al, anodized  
 2 door handles, PA, black  
 Spacer sleeve, PA, black  
 2 flange nuts M4, St, black  
 2 Countersunk Screws DIN 7991-M4x12, St, bright zinc-pl.  
 4 sleeves, St, bright zinc-plated  
 Notes on Use and Installation  
 m = 1.3 kg

1 set 0.0.458.33

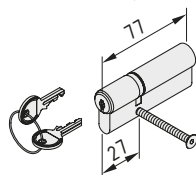

**Profile Cylinder**



Cylinder matt nickel-plated, all keys identical  
 Countersunk Screw M5x80, St  
 3 keys  
 m = 250.0 g

1 pce. 0.0.458.42

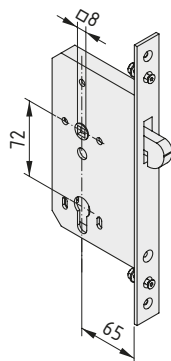

**Sliding-Door Lock**



Lock insert, St, suitable for standard cylinder locks  
 2 drive nuts M4, St, black  
 2 Countersunk Screws DIN 7991-M4x12, St, bright zinc-plated  
 m = 812.0 g

1 set 0.0.458.34

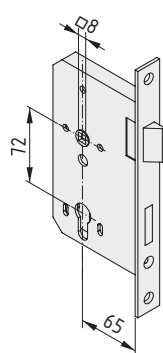

**Swing-Door Lock**



Lock insert with movable latch, St, suitable for standard cylinder locks  
 m = 850.0 g

1 pce. 0.0.458.35

**Fastening Set 6 for Lock System 6-8**



2 T-Slot Nuts 6 St M6, bright zinc-plated  
 2 Counters. Screws DIN 7991-M6x12, St, bright zinc-plated  
 m = 15.0 g

1 set 0.0.459.05

**Fastening Set 8 for Lock System 6-8**



2 T-Slot Nuts 8 St M6, bright zinc-plated  
 2 Counters. Screws DIN 7991-M6x14, St, bright zinc-plated  
 m = 27.0 g

1 set 0.0.458.36







## Dual-Rod Mesh Lock System

- Universal fastening system for right and left-handed doors
- Uses conventional mortise locks in line with DIN 18251
- Special mechanism to enable secure fitting to dual rod meshes

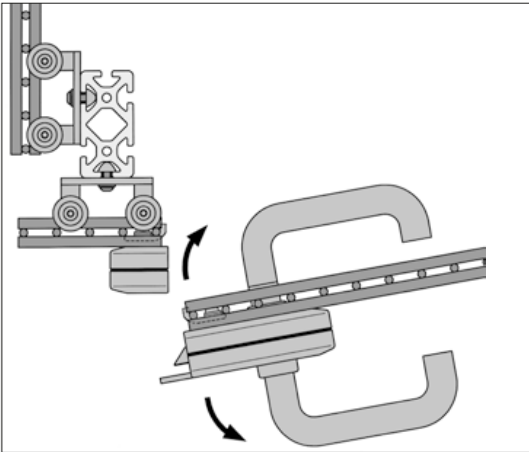

Thanks to its universal fastening options, the Dual-Rod Mesh Lock System allows left-handed or right-handed fitting. A hole may need to be made in the Dual-Rod Mesh to allow the door handle to be fed through.

The Dual-Rod Mesh Lock System includes all required fixing elements. Clamping Elements and pressed steel plates enable secure mounting on all types of dual rod mesh.

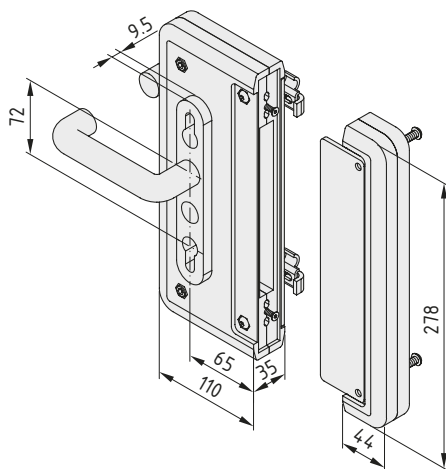

### Dual-Rod Mesh Lock System

- Lock housing, PA-GF, black
- Lock case, PA-GF, black with nab, St
- Lock housing rabbet, St, black
- 2 door handles, PA, black
- 4 Dual-Rod Mesh Clamping Elements, St, black
- 4 Dual-Rod pressed steel plates, St, black
- 4 sleeves, St, bright zinc-plated
- Fastening elements
- Notes on Use and Installation
- m = 1.7 kg

1 set

0.0.446.09

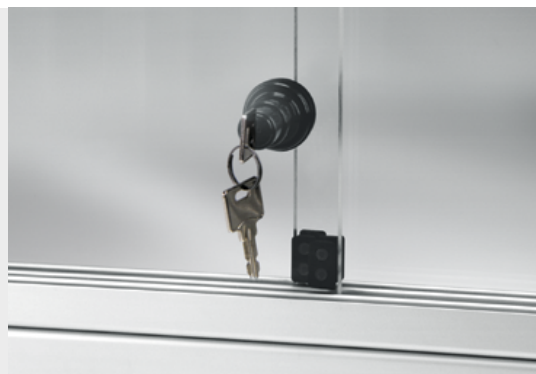

## Sliding-Door Pin Lock

- Pin locks sliding doors together
- Installed directly into the panel element

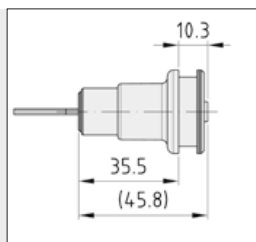
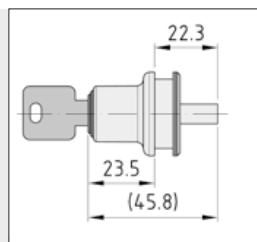

Mounting dimensions, locked and unlocked.

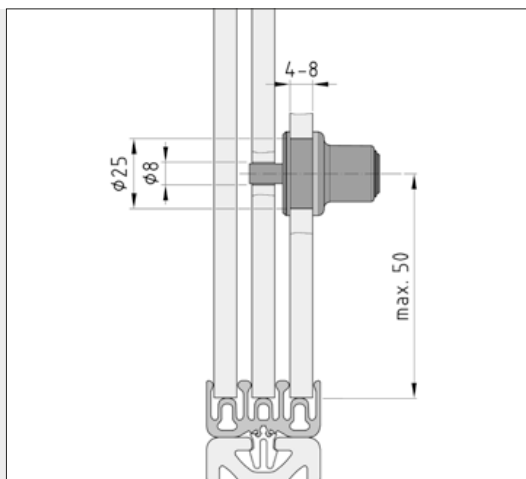

Processing the panel elements for accommodating the Sliding-Door Pin Lock and pin.

To lock a sliding-door system with  $n$  door elements,  $n-1$  Sliding-Door Pin Locks will be required.

The Sliding-Door Pin Lock should be installed in close proximity to the guide profiles in order to offer maximum protection against the door being opened by force.

The different thicknesses of panel element (from 4 to 8 mm) can be compensated by using Spacers (2 and 0.7 mm thick).

9

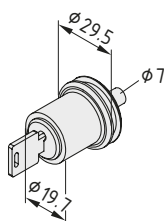

### Sliding-Door Pin Lock

Die-cast zinc/St, black  
 Washer, PA, black  
 2 keys, identical  
 Notes on Use and Installation  
 m = 86.0 g

1 set

0.0.474.59