

1/4" JRPH/JRPL Series

Pressure Reducing Valves

PRESSURE REDUCING VALVES

The 1/4" LowFlow JRPH Series and JRPL Series are piston operated pressure regulators that offer excellent control at Cv's of 0.20 and lower. There are six set ranges for the JRPH Series and two set ranges for the JRPL Series. Elastomer seals are used throughout with Buna-N, EPDM, and Viton being standard options. These valves are designed to regulate a variety of general, corrosive and specialty gases, water, acids and oils.

Features:

- All wetted materials are 316L Stainless Steel. Other materials available on application
- Soft PEEK, PTFE or Kel-F seat provides ANSI Class VI Shutoff
- Piston Sensing for better regulation at higher pressures
- ANSI Class VI Shutoff
 - JRPL: PEEK, PTFE or Kel-F
 - JRPH: PEEK or Kel-F
 - Contact factory for additional options



JRPH/JRPL SERIES FLOW CONFIGURATIONS

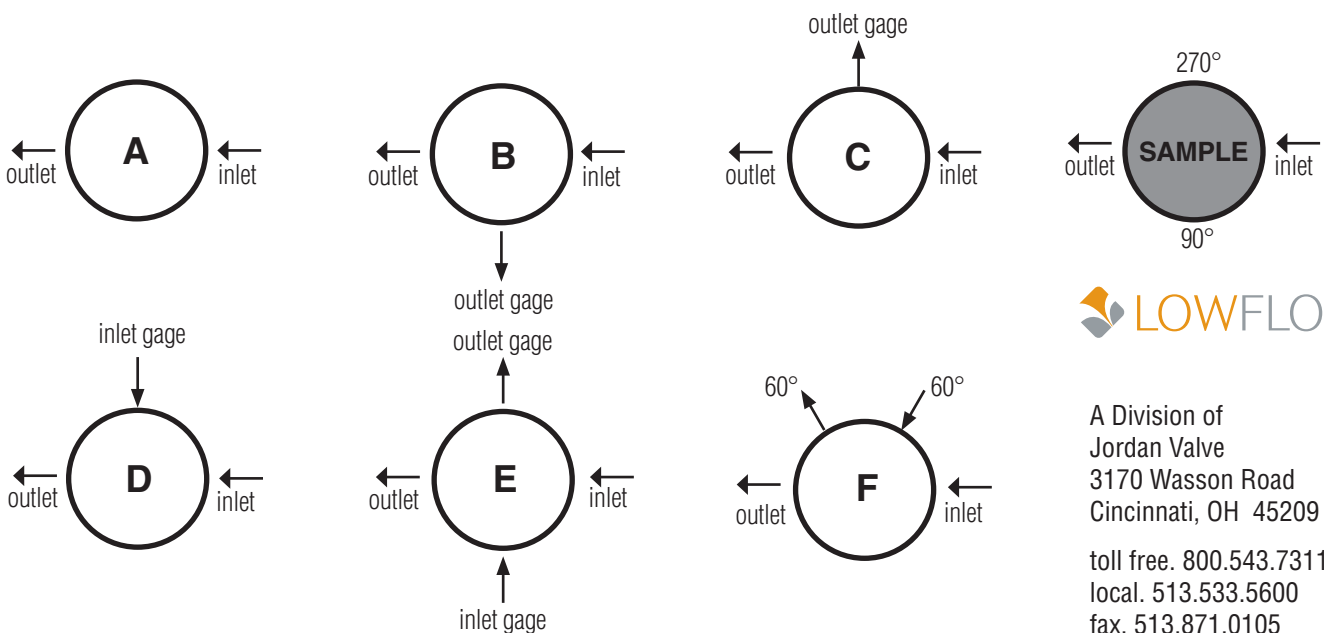

A Division of
Jordan Valve
3170 Wasson Road
Cincinnati, OH 45209

toll free. 800.543.7311
local. 513.533.5600
fax. 513.871.0105

www.lowflowvalve.com

Top View

* Gage ports are 1/4" FNPT; Consult factory for other porting options

JRPH SERIES SPECIFICATIONS

Line Size: 1/4" (DN8)

Materials

- All wetted parts - 316L Stainless Steel. Others on application
- Body Seals: Elastomer O-rings (Buna-N, EPDM, Viton)

Soft Seat: PEEK or Kel-F

Spring Ranges

- 0 - 1450 psi (0 - 100 bar)
- 0 - 2535 psi (0 - 175 bar)
- 0 - 4000 psi (0 - 275 bar)
- 0 - 5075 psi (0 - 350 bar)
- 0 - 6000 psi (0 - 410 bar)
- 0 - 9135 psi (0 - 630 bar)

Seat Diameter: 0.40" (10mm)

Maximum Operating Pressure: 10,100 psi max inlet @ 100°F / 3,000 psi max ΔP (700 bar max inlet @ 38°C / 207 bar max ΔP)

Maximum Operating Temperature: 350°F @ 8,265 psi max inlet (177°C @ 570 bar max inlet)

End Connections

- 1/4" Threaded Ends - FNPT or BSPP
- Others: Socket Weld, Butt Weld or Flanged

Shutoff: Class VI

Flow Capacity:

- Cv 0.012 (Kv 0,010)
- Cv 0.03 (Kv 0,02)
- Cv 0.07 (Kv 0,06)
- CV 0.2 (Kv 0,17)

Options

- Panel Mounting
- Captured Vent
- Locking Wire
- Tamper Proof
- Lockout Device

JRPL SERIES SPECIFICATIONS

Line Size: 1/4" (DN8)

Materials

- All wetted parts - 316L Stainless Steel. Others on application
- Body Seals: Elastomer O-rings (Buna-N, EPDM, Viton)

Soft Seat: PEEK, PTFE or Kel-F

Spring Ranges

- 0-500 psi (0-35 bar)
- 0-800 psi (0-55 bar)

Seat Diameter: 0.40" (10mm)

Maximum Operating Pressure: 4,000 psi max inlet @ 100°F / 3,000 psi max ΔP (275 bar max inlet @ 38°C / 207 bar max ΔP)

Maximum Operating Temperature: 350°F @ 4,000 psi max inlet (177°C @ 275 bar max inlet)

End Connections

- 1/4" Threaded Ends - FNPT or BSPP
- Others: Socket Weld, Butt Weld or Flanged

Shutoff: Class VI

Flow Capacity:

- Cv 0.012 (Kv 0,010)
- Cv 0.03 (Kv 0,02)
- Cv 0.07 (Kv 0,06)
- CV 0.2 (Kv 0,17)

Options

- Panel Mounting
- Captured Vent
- Locking Wire
- Tamper Proof
- Lockout Device

JRPH & JRPL SERIES SPECIFICATIONS

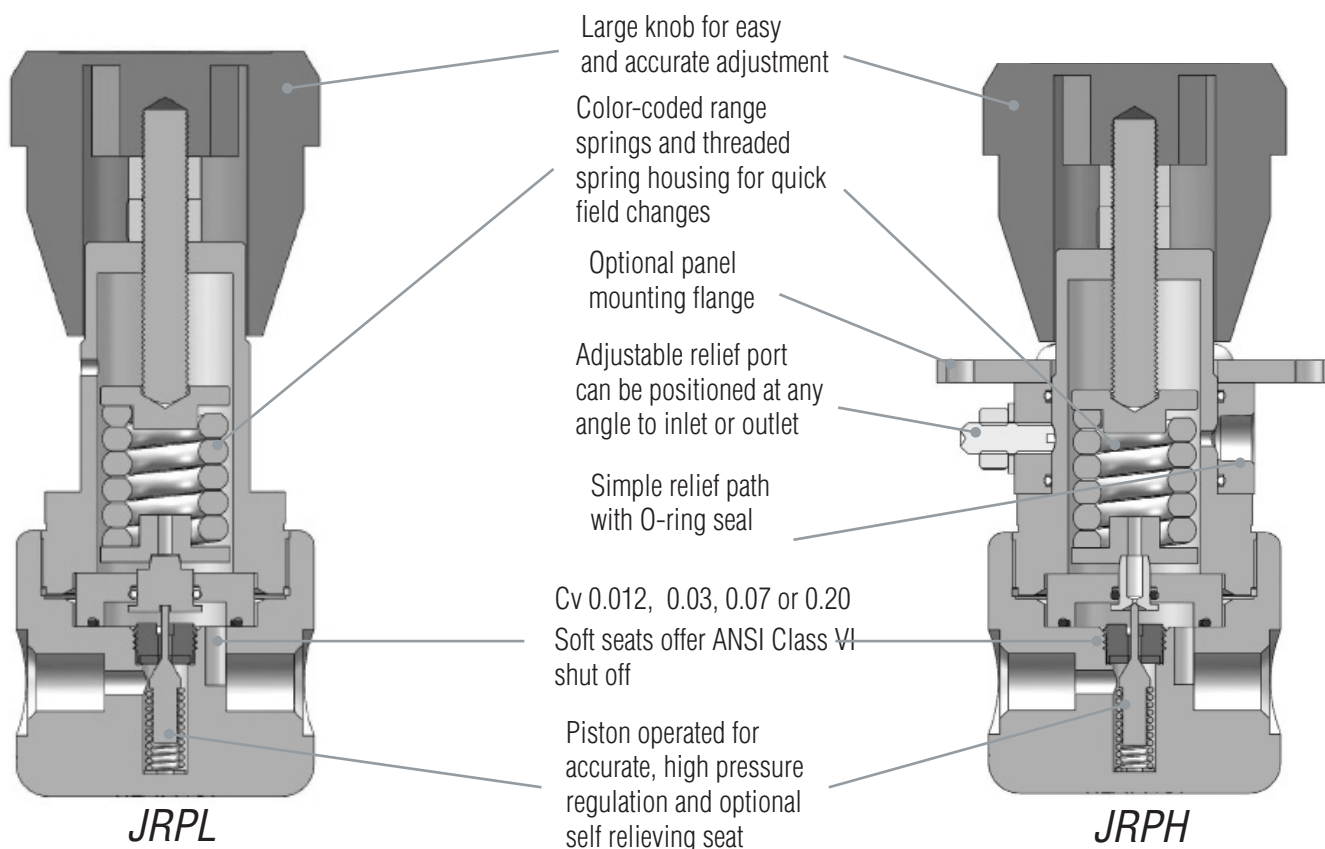

* JRPH shown with captured vent and panel mount options

OPTIONS & DEFINITIONS

Panel Mount The panel mount feature utilizes a threaded spring housing and a panel mount ring to secure the regulator to an instrument panel. This option requires a 1-1/2" panel cut out.

Captured Vent The captured vent design provides maximum safety for the user when handling toxic or hazardous media. It features a 1/8" FNPT port located on the spring housing. The user can easily tube this vent to a safe location. This option can be incorporated into a self-relieving regulator that provides an additional port to permit the safe expulsion of hazardous media.

Self Relieving The self relieving option is used for internal venting of downstream pressure. From a practical standpoint, it allows for immediate reduction in pressure setpoints and automatically alleviates regulator lock up.

Locking Wire The locking wire option utilizes a lead sealed metal wire to physically hold the adjusting screw in place to prevent any unwanted set point changes.

Tamper Proof The tamper proof option replaces the standard adjusting knob with a stainless steel acorn nut.

Lockout Device The lockout device is a 2 piece polypropylene enclosure which encapsulates the adjustment knob and prevents unwanted set point changes. The part number required for this valve is 26970. (Lock not included)

JRPH & JRPL SERIES DIMENSIONS

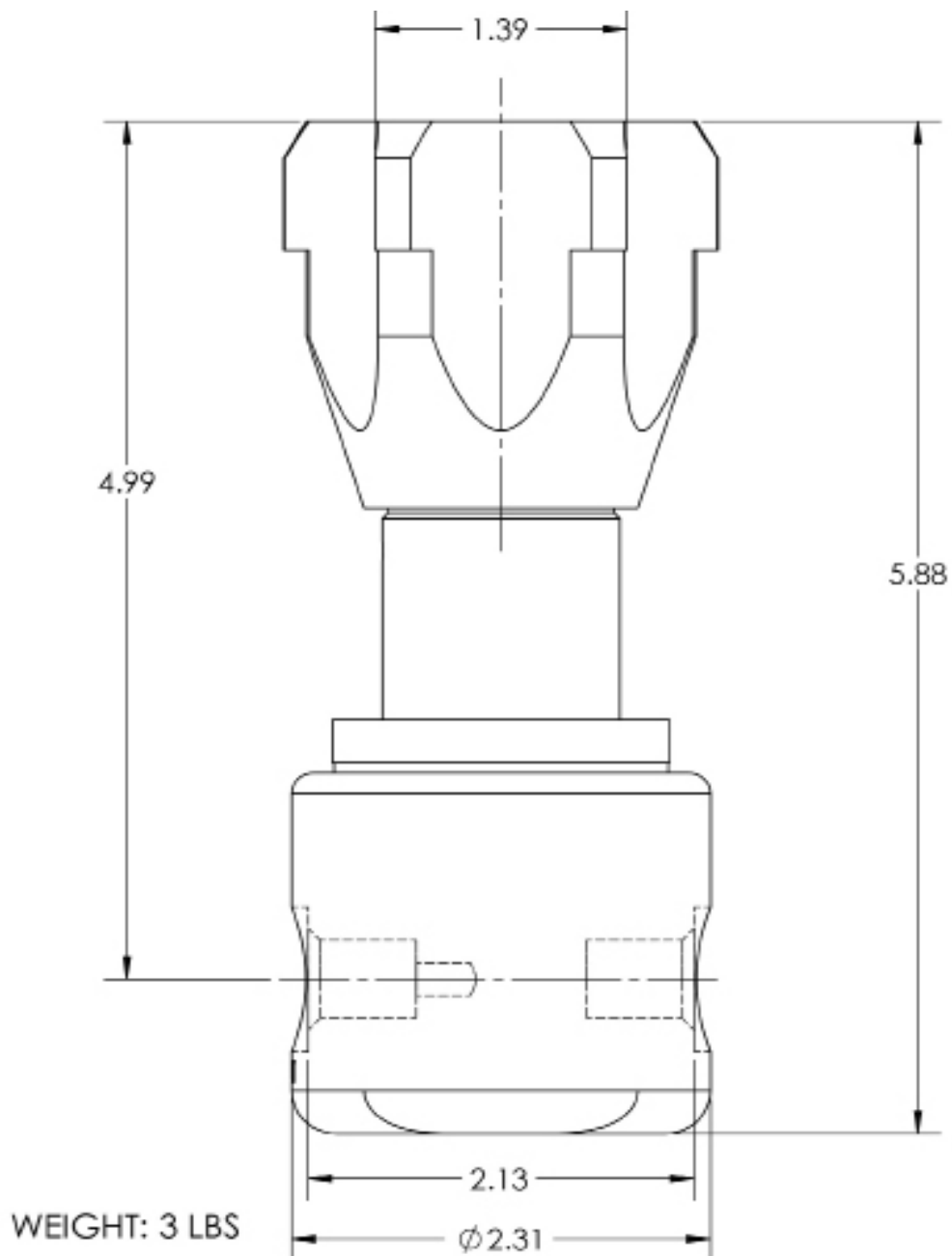

JRPH & JRPL SERIES SIZING

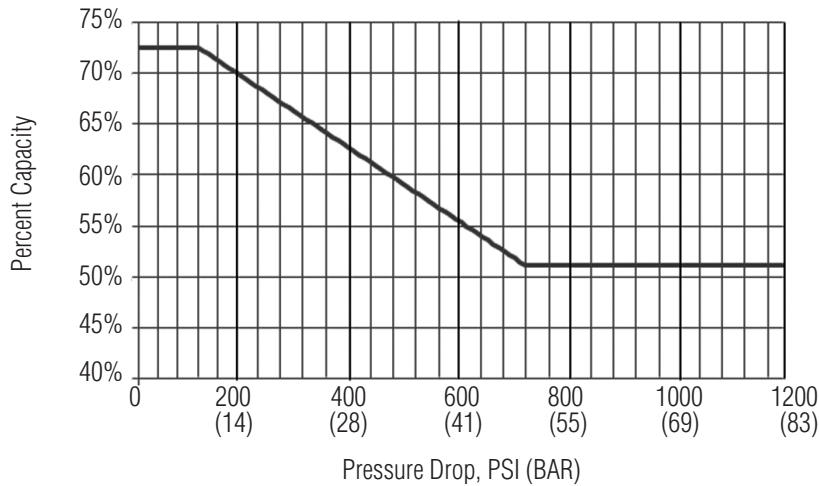

SIZING

1. Find the pressure drop on the X-axis
2. Draw a line, parallel with the Y-axis to the point where it intersects the curve on the graph
3. Draw a line, parallel with the X-axis to the Y-axis. This will determine the percent capacity that will work with the pressure drop.
4. Check JVCV (Jordan Valve Control Sizing Program) to verify percent capacity is not exceeded
5. Note: From 720 psi (50 bar) pressure drop to maximum pressure drop (3000 psi / 207 bar) use 51% capacity

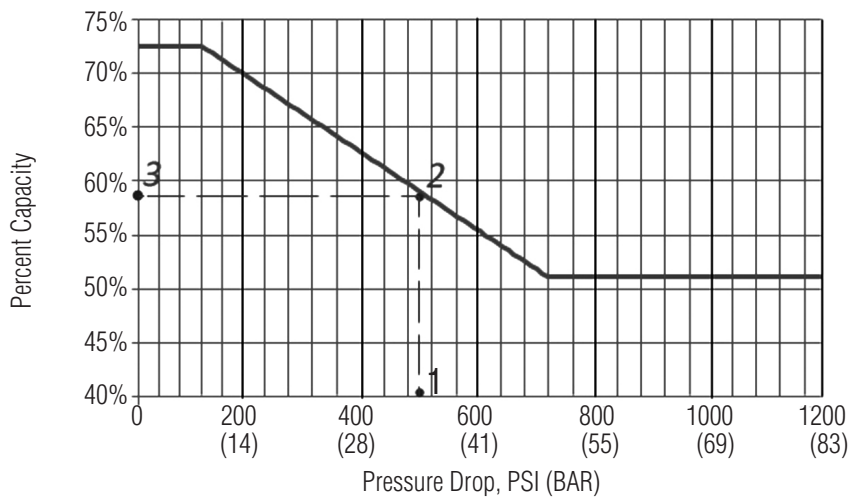

EXAMPLE

Methane gas, ambient temperature, P1 - 1400 psi, P2=900 psi, 3/4" schedule 40 pipe, flow rate 50,000 SCFH

1. Pressure drop of 500 psi.
2. Draw a line, parallel with the Y-axis to the point where it intersects the curve on the graph
3. Draw a line, parallel with the X-axis to the Y-axis. This will determine the percent capacity that will work with the pressure drop. The percent capacity you can use is 58% of the rated Cv.
4. Input the process conditions into the JVCV sizing program. Using the conditions in this example, a 3/4" JRPL with 0 - 1160 range spring will be 43% open, lower than the 58% capacity based on the pressure drop.

JRPH SERIES ORDERING SCHEMATIC

Model	Size	Material	1 & 2	3 & 4	5 & 6	7 & 8	9 & 10	11 & 12	13 & 14	15	16	17
—	—	—	—	—	—	—	—	—	—	—	—	—

Model	
JRPH	High Range

Size	
025	1/4" (DN8)

Material	
6L	Stainless Steel 316L

1 & 2	Body Feature	
End Connection	Port Configuration	
C	FNPT 1/4"	A Port "A"
F	BSPP 1/4"	B Port "B"
		C Port "C"
		D Port "D"
		E Port "E"
		F Port "F"
ZZ	Non-Standard	

3 & 4	Trim
BB	Buna-N
EE	EPDM
VV	Viton
BR	Buna-N Self Relieving
ER	EPDM Self Relieving
VR	Viton Self Relieving
ZZ	Non-Standard

5 & 6	Seat
K2	KEL-F Cv 0.012 (Kv 0,010)
K3	KEL-F Cv 0.03 (Kv 0,02)
K5	KEL-F Cv 0.07 (Kv 0,06)
K8	KEL-F Cv 0.20 (Kv 0, 17)
P2	PEEK Cv 0.012 (Kv 0,010)
P3	PEEK Cv 0.03 (Kv 0,02)
P5	PEEK Cv 0.07 (Kv 0,06)
P8	PEEK Cv 0.20 (Kv 0,17)
ZZ	Non-Standard

7 & 8	Range Spring/Outlet Pressure
S4	0 - 1450 psi (0 - 100 bar)
S5	0 - 2535 psi (0 - 175 bar)
S3	0 - 4000 psi (0 - 275 bar)
S6	0 - 5075 psi (0 - 350 bar)
S8	0 - 6000 psi (0 - 410 bar)
S7	0 - 9135 psi (0 - 630 bar)
ZZ	Non-Standard

9 & 10	Piston
AA	Standard
ZZ	Non-Standard

11 & 12	Actuator
SK	Standard
CV	Captured Vent
PM	Panel Mount
PC	Panel Mount - Captured Vent
TP	Tamper Proof
LW	Locking Wire
ZZ	Non-Standard

13 & 14	Inlet Gauge
LL	0 - 3000 psig/bar (dual)
MM	0 - 5000 psig/bar (dual)
PP	0 - 10000 psig/bar (dual)
QQ	0-15000 psig/bar (dual)
NN	None
ZZ	Non-Standard

15	Outlet Gauge
K	0 - 2000 psig/bar (dual)
L	0 - 3000 psig/bar (dual)
M	0 - 5000 psig/bar (dual)
P	0 - 10000 psig/bar (dual)
Q	0-15000 psig/bar (dual)
N	None
Z	Non-Standard

16	SEP Compliance
G	SEP Compliant
0	None
Z	Non-Standard

17	Accessories
S	Clean for Oil Free*
X	Clean for Oxygen*
0	None
Z	Non-Standard

*Consult factory for compatible gauge options

JRPL SERIES ORDERING SCHEMATIC

Model	Size	Material	1 & 2	3 & 4	5 & 6	7 & 8	9 & 10	11 & 12	13 & 14	15	16	17
—	—	—	—	—	—	—	—	—	—	—	—	—

Model	
JRPL	Low Range

Size	
025	1/4" (DN8)

Material	
6L	Stainless Steel 316L

1 & 2	Body Feature	
End Connection		Port Configuration
C	FNPT 1/4"	A Port "A"
F	BSPP 1/4"	B Port "B"
		C Port "C"
		D Port "D"
		E Port "E"
		F Port "F"
ZZ	Non-Standard	

3 & 4	Trim
BB	Buna-N
EE	EPDM
VV	Viton
BR	Buna-N Self Relieving
ER	EPDM Self Relieving
VR	Viton Self Relieving
ZZ	Non-Standard

5 & 6	Seat
K2	KEL-F Cv 0.012 (Kv 0,010)
K3	KEL-F Cv 0.03 (Kv 0,02)
K5	KEL-F Cv 0.07 (Kv 0,06)
K8	KEL-F Cv 0.20 (Kv 0, 17)
P2	PEEK Cv 0.012 (Kv 0,010)
P3	PEEK Cv 0.03 (Kv 0,02)
P5	PEEK Cv 0.07 (Kv 0,06)
P8	PEEK Cv 0.20 (Kv 0,17)
T2	PTFE Cv 0.012 (Kv 0,010)
T3	PTFE Cv 0.03 (Kv 0,02)
T5	PTFE Cv 0.07 (Kv 0,06)
T8	PTFE Cv 0.20 (Kv 0,17)
ZZ	Non-Standard

7 & 8	Range Spring/Outlet Pressure
S1	0 - 500 psi (0-35 bar)
S2	0-800 psi (0-55 bar)

9 & 10	Piston
AA	Standard
ZZ	Non-Standard

11 & 12	Actuator
SK	Standard
CV	Captured Vent
PM	Panel Mount
PC	Panel Mount - Captured Vent
TP	Tamper Proof
LW	Locking Wire
ZZ	Non-Standard

13 & 14	Inlet Gauge
JJ	0-1000 psig/bar (dual)
LL	0 - 3000 psig/bar(dual)
MM	0 - 5000 psig/bar (dual)
NN	None
ZZ	Non-Standard

15	Outlet Gauge
J	0-1000 psig/bar (dual)
K	0 - 2000 psig/bar (dual)
N	None
Z	Non-Standard

16	SEP Compliance
G	SEP Compliant
0	None
Z	Non-Standard

17	Accessories
S	Clean for Oil Free*
X	Clean for Oxygen*
0	None
Z	Non-Standard

*Consult factory for compatible gauge options

JRPL_1/4/0715