

Drinking Water Analysis safe and simplified

The new Standard in Online Water Quality Monitoring



bürkert
FLUID CONTROL SYSTEMS

INSPIRING ANSWERS | TYPE 8905

Reliable analysis of drinking water has never been so simple!

Throughout the world, the WHO (World Health Organization) and local authorities strive to create regulations and guidelines to protect public health, to ensure the highest levels of water quality and to establish monitoring procedures. The Type 8905 Online Analysis System was developed to help water suppliers to comply with guidelines: it enables monitoring and data logging in the time between stipulated laboratory tests. With its very compact housing, it monitors the key parameters directly in the system on a continuous and highly economical basis.

Thanks to innovative microelectronics we were able to develop a modular and extremely compact monitoring device, with the sensor chips entirely manufactured in our clean room in Triembach-au-Val, France. The uncompromising miniaturisation of sensor elements and intelligent control enable flexible selection and combination of the exact sensor components relevant for your analysis process.

Potential applications of the Type 8905

- Treatment of drinking water
- Distribution of drinking water
- Industrial waste water recovery
- Industrial cleaning processes

The Type 8905 at a glance

- Compact housing for display unit and up to six sensor elements – Sensor Cubes (currently available: ORP, pH, chlorine, turbidity, conductivity)
- Hot-swap sensor replacement or addition via simple plug-in during uninterrupted operation
- Consistent digital communication via operation-monitoring system (bÜS)
- Uniform operating interface for all functions (can also be expanded in various ways with sensors outside of the housing)





Discover the new standard in Online Water Analysis

Everything at a glance

Continuous water analysis is a very complex undertaking in practice. In most cases, there are different systems with independent sensors, individual displays and entirely different controls. On the large 7" touchscreen display of the Type 8905 device, however, all measurement values can be seen at a single glance. Its intuitive user controls and uniform user interface make it extremely simple to use.



Six slots for innovation

The compact housing offers slots for up to six innovative Sensor Cubes and thus provides ample space for the analysis of key parameters. These slots can be individually equipped with sensors relevant for your specific application. New sensors can also be retrofitted very easily. The modular design and underlying EDIP electronics platform also enable 'hot-swapping' (the insertion of new Sensor Cubes during operation). The Sensor Cubes log into the bûS system and provide their full functionality to the other bûS members after registration.





Simple and efficient

Type 8905 is based on Bürkert's own EDIP electronics platform – Efficient Device Integration Platform – and represents the new Bürkert product generation, including a common user interface and digital communication, which not only greatly simplify device operation but, as a system, also allow for easy integration.

powered by
EDIP

Compact and modular

The compact housing enables continuous analysis even in the smallest spaces. Large test structures with numerous independent sensors, cables and displays are a thing of the past. All the electronics are located in the upper part of the housing along with the large display. The lower part of the housing has six slots for compact Sensor Cubes. If further parameters have to be analyzed, sensors can be easily added. The results can also be evaluated with the primary unit and displayed on the screen.



So small but yet complete

Miniaturisation of sensor elements is the primary innovation of Type 8905 Online Analysis System. The ultra-compact Sensor Cubes can be very easily added to the basic module and log into the system with their configuration and sensor specifications thanks to EDIP. This modular design makes it possible to easily retrofit new sensors in any combination. Thanks to miniaturisation, the individual cubes need only a small amount of test water to provide reliable results. The selection of different sensor types is expanded gradually, so that soon there will be a corresponding sensor available for all relevant parameters.



Every cube a marvel of miniaturisation

The compact Sensor Cubes are the heart of the system. Each one has an independent measuring unit for the analysis of different parameters. Here, the results are converted directly into digital values and passed on to the system for further processing. The cubes are compatible with all EDIP-based devices which communicate internally via Bürkert's own bÜS system. All calibration values are stored in the cube, so no recalibration is necessary after removal and refitting.

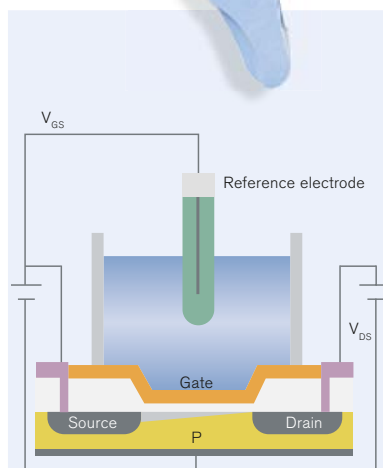

pH value

The pH measurement is based on the ISFET Technology (ion-sensitive field effect transistor). The pH value is the negative logarithm of hydrogen ion activity in a solution and provides valuable information about the water condition.

pH sensor cube:

- Chlorine-resistant coating of gate
- Long service intervals thanks to an easily exchangeable unit with reference electrode and KCl solution
- Quick response time: < 10 s

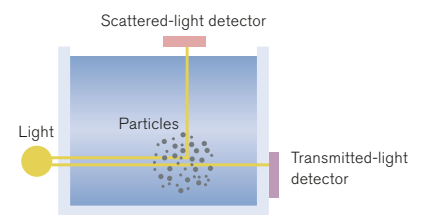

TURBIDITY

The turbidity of water is related to the undissolved content in water. So this parameter is an indicator of aesthetic condition and of possible hidden microbiological content in the water.

Turbidity sensor cube:

- Complies with DIN ISO 7027 or EPA method 180.1
- Measurement range: 0–40 FNU +/- 0.02 FNU
- Light intensity controlled by measurement diodes
- Low test water flow rate of 6l/h
- Replaceable measurement chamber



There are slots for up to six of these Sensor Cubes in the standard housing of the Type 8905. In total (depending on bus length) there can be up to 30 Sensor Cubes in one bus system.

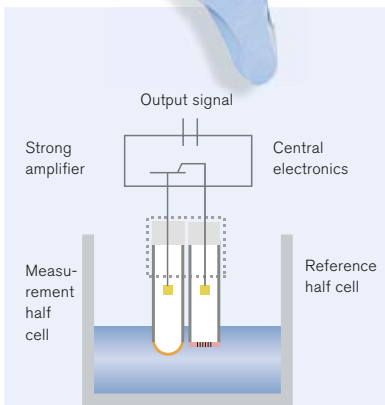

ORP VALUE

The oxidation-reduction potential (ORP) is one of the main water parameters. It is an indicator of the disinfection potential of water.

ORP sensor cube:

- Pt electrode with Ag/AgCl reference system
- Measurement requires minimal sample water flow
- Long service intervals thanks to an easily exchangeable unit with reference electrode and KCl solution

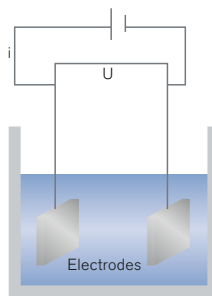

CONDUCTIVITY

Conductivity describes the water's ability to conduct electricity. This value is an indicator of the quantity of dissolved substances in a water sample.

Conductivity sensor cube:

- Measuring range: 50 $\mu\text{S}/\text{cm}$ –1,000 $\mu\text{S}/\text{cm}$
- Graphite electrode
- Long-term calibration stability

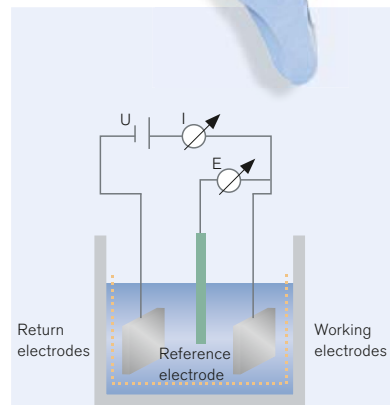

CHLORINE

A high-precision, membrane-covered, amperometric Pt-Pt sensor measures the free-chlorine concentration of water. The monitoring of chlorine concentration is important for the control of disinfection processes.

Chlorine sensor cube:

- Control of disinfection
- Long-term calibration stability
- No separate KCl reference solution required
- Quick response time: <30 s

In-house expertise as the basis of our success

The modular and extremely compact design of the Type 8905 Online Analysis System is made possible only through the use of sophisticated MEMS technology (microelectromechanical systems), developed and produced by an experienced team of specialists in our clean room in Triembach-au-Val.

Calling all specialists

The technology used in the production of MEMS components is derived from conventional clean room processes for IC production. A multidisciplinary team consisting of physicists, chemists, electrical engineers and clean room specialists provides the special expertise and experience required for the various tasks.



*Insertion and bonding
of chips.*

Benefits of MEMS technology

- Lower weight
- Lower sample volume
- Lower energy consumption
- Improved temperature qualities
- High resistance to vibrations and shocks
- Extremely quick response time thanks to miniaturisation



The test piece for the electrical connections is located under the manual bonder for the deep access wedge.

The entire micro-sensor production process takes place under our clean-room conditions.



The surfaces are cleaned and activated using a plasma beam.

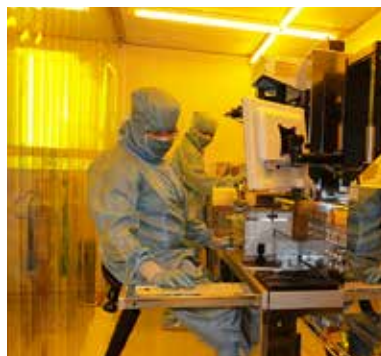

Ultra-modern wafer production.

powered by
EDIP

Our EDIP platform provides unlimited opportunities

EDIP – Efficient Device Integration Platform – is the electronics platform of the new Bürkert product generation, with a common user interface and digital communication. The platform does not only make it significantly easier for product users to operate the devices, but also simplifies integration into another system. EDIP is essentially made up of the following three components: communication, software and hardware

Basic functionalities of EDIP

- Uniform interfaces between devices
- Bürkert Configurator as a standardised software tool and user interface for configuration and operation of all EDIP-supported devices
- New modules are registered automatically by the system, their functionalities are recognised, and they interact with one another
- Fully digital data exchange within the internal operation-monitoring system guaranteed – for example, automatic registration and address allocation as well as equal status of all participants
- Modular hardware components (Compact Connect, System Connect) can be expanded in various ways and adapted to the individual requirements of the user

The System Connect basic component with individual control modules.



SENSORS AND ACTUATORS

Sensor Cubes



Each sensor is an independent unit and sends its data to the EDIP system for further use and reading on the display via the operation-monitoring system.

The cubes can also be removed and refitted during ongoing operation due to their hot-swap capability without any configuration work.

DEVICE COMMUNICATION

Interfaces



The Type 8905 can be integrated into your control system via Ethernet, UMTS or WLAN.

Interfaces are available for all common fieldbus protocols.

SOFTWARE PLATFORM

Bürkert Communicator and büS stick



The Bürkert Communicator is a powerful software tool with a uniform user interface which greatly simplifies usage.

With the büS stick, every USB port becomes an EDIP interface.

CONTROLLER FUNCTIONS

Control

input >>

f(x)

>> output

Thanks to the fully digital communication via the operation-monitoring system, simple controller and control tasks can also be performed quickly and conveniently with the Communicator.

The control centre for your water analysis

With its modular design and EDIP electronics platform, Type 8905 can even process and display measurement results determined by Sensor Cubes installed in a different part of the process. Consequently, the basic device is practically a control centre for water analysis throughout the entire system.

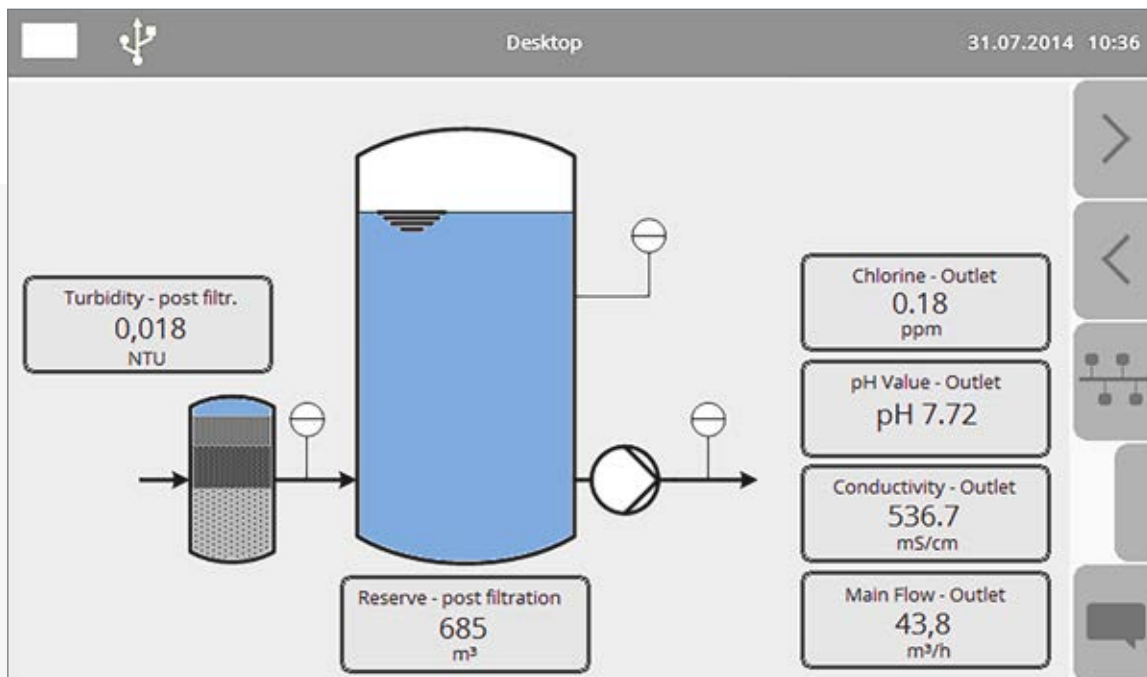

System components and the associated sensors can be represented on the large 7" display (illustration 1:1); there is still sufficient space to include additional externally available EDIP sensors in the system plan if required.

Surface water

Springs and water sources



1

Compact basic unit with display and up to six slots for Sensor Cubes.



2

External sensor unit that can be positioned anywhere in the system.

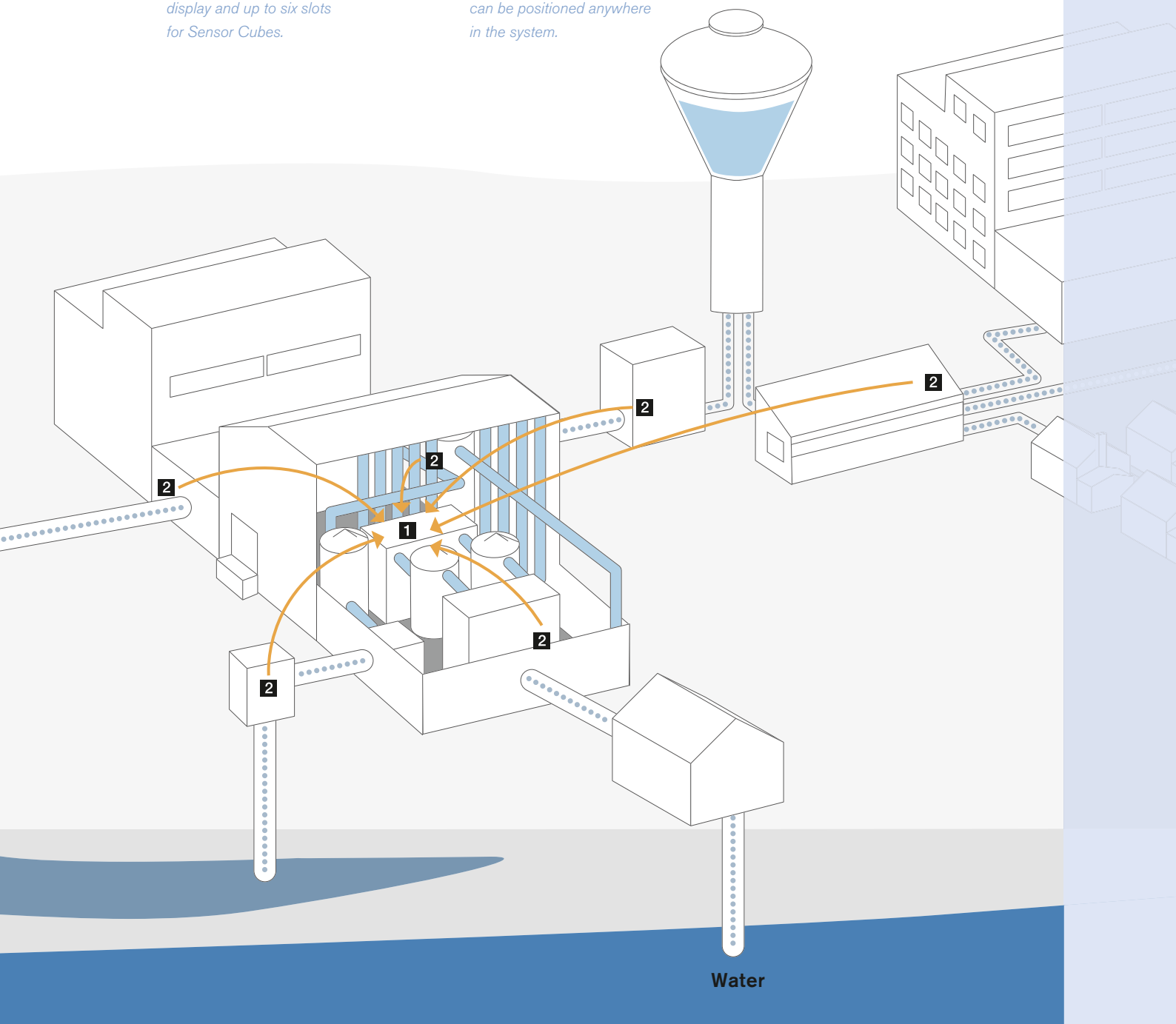

Bürkert – always close at hand

You can find all the current address details at www.burkert.com



Publisher: © and concept: Christian Bürkert GmbH & Co. KG | Implementation: blösch.partner, Eppingen | Photos: Münch Lichtbildneri, Stuttgart.

Bürkert Fluid Control Systems

Christian-Bürkert-Straße 13-17
74653 Ingelfingen
Germany

Phone: +49 (0) 7940 10-111
Fax: +49 (0) 7940 10-91 204

info@burkert.com
www.burkert.com

