



AVAILABLE
FALL 2015

TRADITIONAL

Harness Brown Lustra Leather

ISABELLA

Heads turn when Isabella's in the room. Updated, traditional style with fine tailoring and subtle curves beckon from all angles. Obsessive attention to detail shows in the precise stitching, tailored piping, handsome roll arms and advanced ergonomics.

MODULES

End chairs combine with chair connectors or armless chairs for straight or wedge shaped rows.
Two armless Isabella modules can be joined without arm connectors.

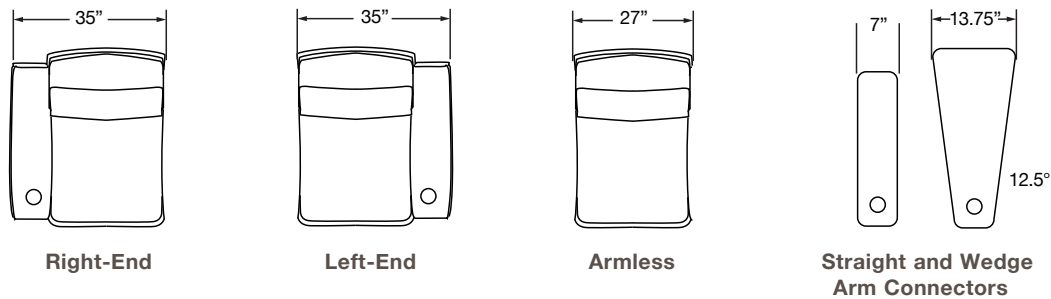

SPECIFICATIONS

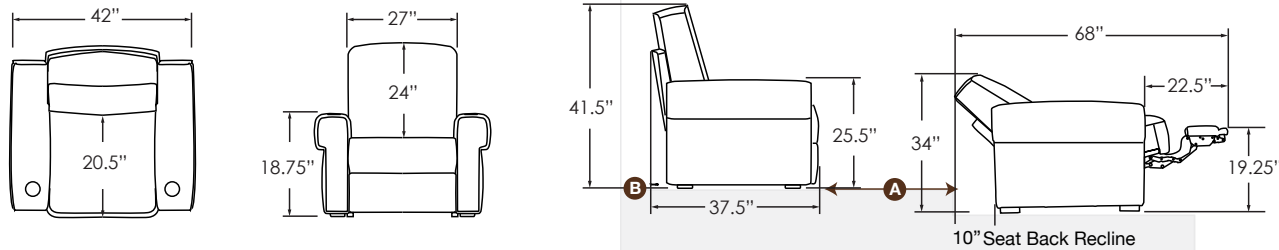

83.5" deep platform recommended with 7" riser step typical.

Dimensional Tolerance:
Allow 1/2" (12mm) to each chair for cushion variation.

MODULAR SOLUTIONS

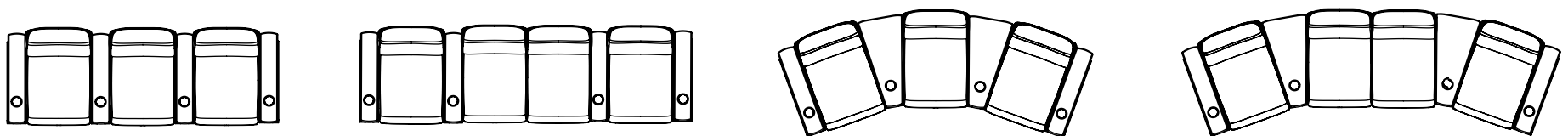

- Wall-away recliner mechanism allows close-to-wall positioning
- Fully-adjustable, motorized* recliner or 3-position manual recliner or non-reclining mechanism
- Leather or microsuede covers
- Tailored, piping with optional contrast piping
- Black, silver or no cup holder

* Power Mechanism Electrical Specifications: 110 V AC, 2.0 amps nominal load, 5.0 amps max load, thermally protected



Design & Quote Custom Theater Seating Online with our **Custom Configurator**
SalamanderDesigns.com



CONTEMPORARY

Chocolate Earth Leather and Root Beer Veluto

OLIVA

More than the ideal choice for a dedicated home theater, Olivia is perfect for today's media room, family room or great room. Chaise and corner connectors easily create cozy "L"-shaped sectionals while straight connector arms allow typical theater rows. Stylish two-tone covers provide even greater design personalization.

MODULES

End chair, chaise or corner modules combine with chair connectors or armless chairs for straight rows or sectionals.
Two armless Olivia modules can be joined without arm connectors.

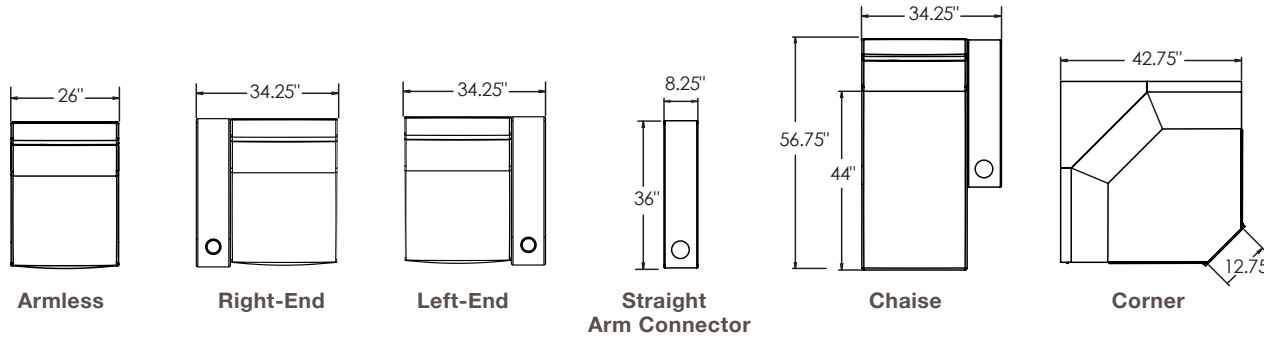

SPECIFICATIONS

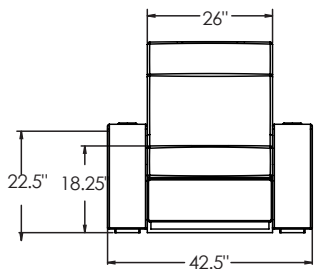

Dimensional Tolerance:
Allow 1/2" (12mm) to each chair for cushion variation.

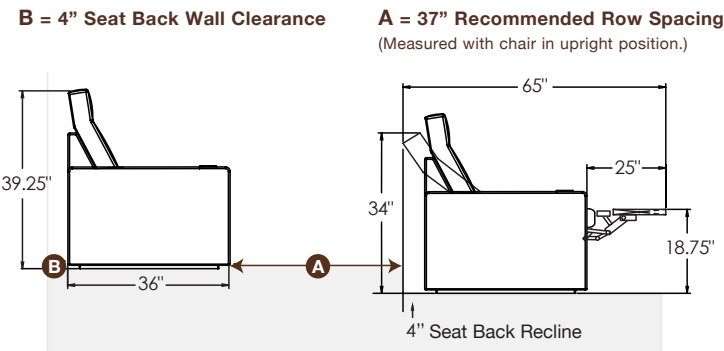

77" deep platform recommended with 7" riser step typical.

MODULAR SOLUTIONS

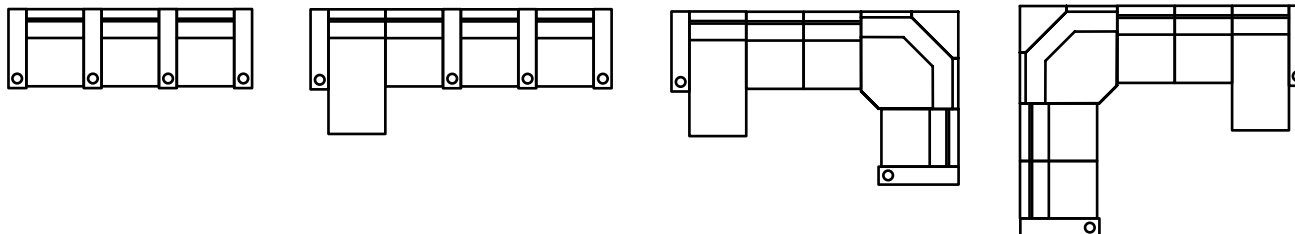

- Wall-away recliner mechanism allows close-to-wall positioning
- Fully-adjustable, motorized* recliner or 3-position manual recliner or non-reclining mechanism
- Corner section is non-reclining and includes 3 loose pillows
- Chaise section is non-reclining
- Stylish two-tone leather and veluto fabric seats provide design personalization
- Tailored, double-needle stitch with optional contrast stitching
- Black, silver or no cup holder

* Power Mechanism Electrical Specifications: 110 V AC, 2.0 amps nominal load, 5.0 amps max load, thermally protected



Design & Quote Custom
Theater Seating Online with our
Custom Configurator
SalamanderDesigns.com



TRANSITIONAL

Whiskey Lustra Leather

TALIA

Generous cushioning and graceful, Modern-inspired curves invite you to be seated while the reclining back and hidden footrest support you in lavish comfort.

MODULES

End chairs combine with chair connectors or armless chairs for straight or wedge shaped rows.
Two armless Talia modules can be joined without arm connectors.

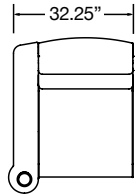

Right-End

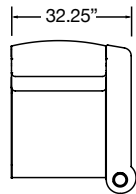

Left-End

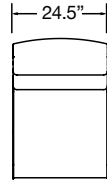

Armless

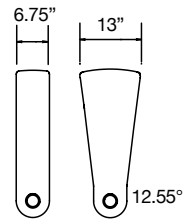

Straight and Wedge
Arm Connectors

SPECIFICATIONS

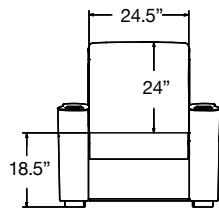
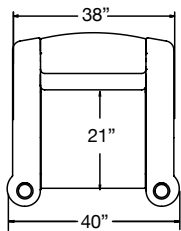

B = 3" Seat Back Wall Clearance

A = 36" Recommended Row Spacing
(Measured with chair in upright position.)

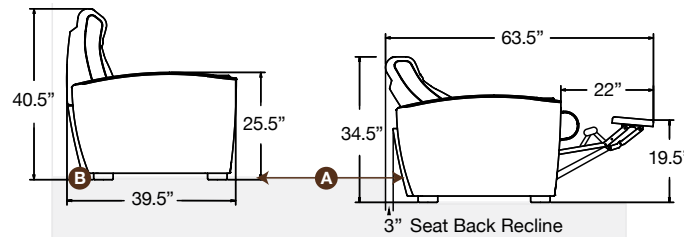

78.5" deep platform recommended with 7" riser step typical.

Dimensional Tolerance:

Allow 1/2" (12mm) to each chair for cushion variation.

MODULAR SOLUTIONS

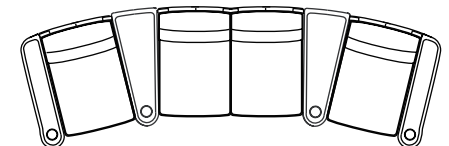
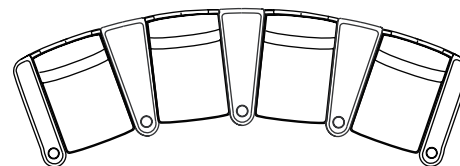
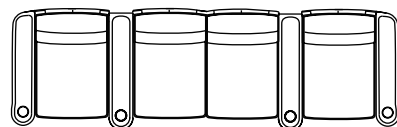
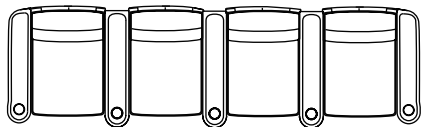

- Wall-away recliner mechanism allows close-to-wall positioning
- Fully-adjustable, motorized* recliner or 3-position manual recliner or non-reclining mechanism
- Leather or microsuede covers
- Tailored, piping with optional contrast piping
- Black, silver or no cup holder

* Power Mechanism Electrical Specifications: 110 V AC, 2.0 amps nominal load, 5.0 amps max load, thermally protected



Design & Quote Custom
Theater Seating Online with our
Custom Configurator
SalamanderDesigns.com



CONTEMPORARY

MATTEO

Matteo provides the comfort of a large, embracing chair on a relatively small footprint. This is a great benefit in applications where a large number of seats must fit into a limited space.

MODULES

End chairs combine with chair connectors or armless chairs for straight or wedge shaped rows.
Two armless Matteo modules can be joined without arm connectors.

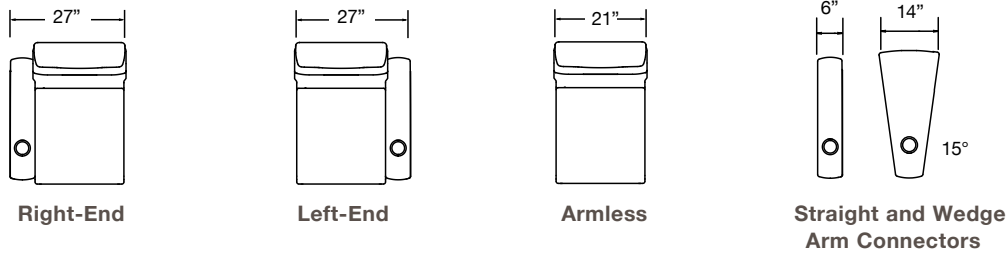

SPECIFICATIONS

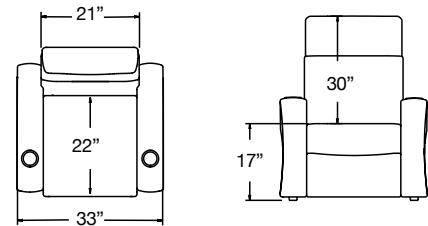

B = 20" Seat Back Wall Clearance

A = 44" Recommended Row Spacing
(Measured with chair in upright position.)

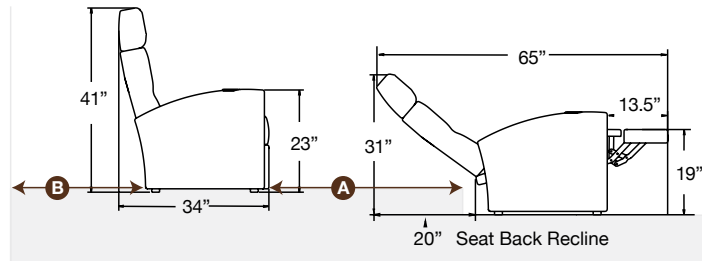

98" deep platform recommended with 7" riser step typical.

Dimensional Tolerance:

Allow 1/2" (12mm) to each chair for cushion variation.

- Small footprint with premium comfort
- Adjustable headrest for just-right support
- Fully-adjustable, motorized* recliner or 3-position manual recliner or push on arm non-reclining recliner
- Leather or microsuede covers
- Tailored, double-needle stitch with optional contrast stitching
- Black, silver or no cup holder

* Power Mechanism Electrical Specifications: 110 V AC, 2.0 amps nominal load, 5.0 amps max load, thermally protected



Design & Quote Custom Theater Seating Online with our Custom Configurator
SalamanderDesigns.com

MODULAR SOLUTIONS

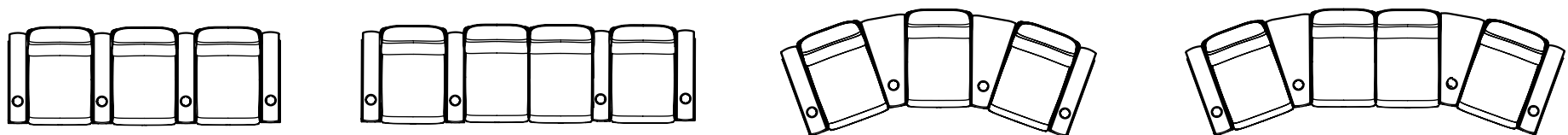



TRANSITIONAL

Hazelnut, Vintage Leather

ALEX

Inspired by the classic club chair, the Alex's swooping arms and low-slung profile give it a sensuous style with timeless appeal. It's low seat back enables a full surround sound experience, making this the perfect audiophile listening chair. A unique incline mechanism provides elevated leg support, while maintaining an upright seat back position. This thoughtful design ensures a heightened sensory experience.

MODULES

End chairs combine with chair connectors or armless chairs for straight or wedge shaped rows.
Two armless Alex modules can be joined without arm connectors.

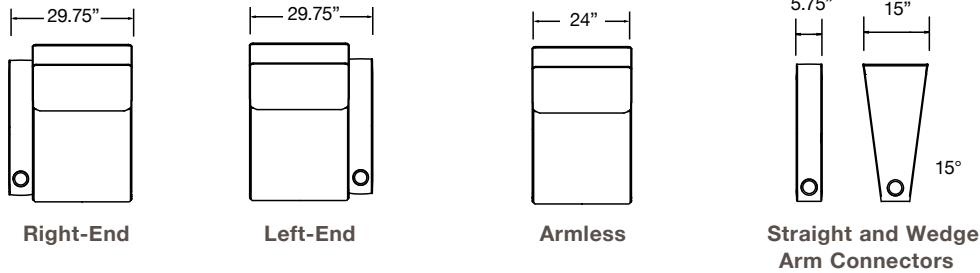

SPECIFICATIONS

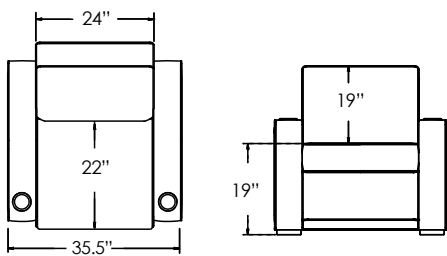

B = 0" Seat Back Wall Clearance **A = 34" Recommended Row Spacing**
(Measured with chair in upright position.)

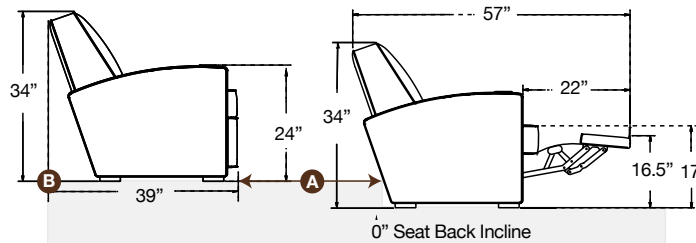

73" deep platform recommended with 7" riser step typical.

Dimensional Tolerance:
Allow 1/2" (12mm) to each chair for cushion variation.

MODULAR SOLUTIONS

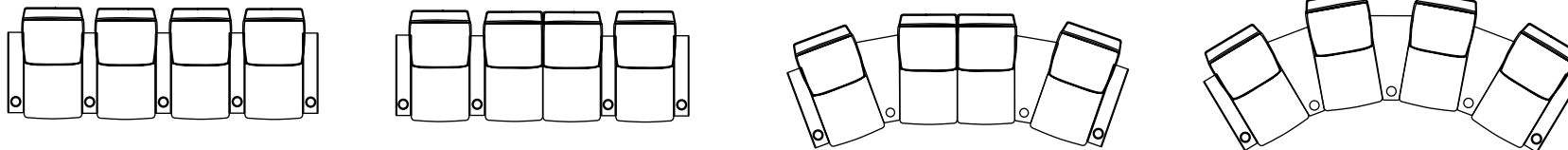

- Wall-away incline manual or powered mechanism* provides elevated leg support, while maintaining an upright seat back position
- Leather or microsuede covers
- Tailored, piping with optional contrast piping
- Black, silver or no cup holder

* Power Mechanism Electrical Specifications: 110 V AC, 2.0 amps nominal load, 5.0 amps max load, thermally protected



Design & Quote Custom Theater Seating Online with our Custom Configurator
SalamanderDesigns.com