



# SYNERGY<sup>®</sup>

## SYSTEM





At the heart of the Synergy System™ is the patented S-Frame, a unique square shaped extruded aluminum support post that permits a virtually limitless number of customization possibilities. The post is used simultaneously as an external cabinet skeleton for supporting top, bottom, side and back panels; and as an internal skeleton for supporting shelves, drawers and additional advanced performance options.

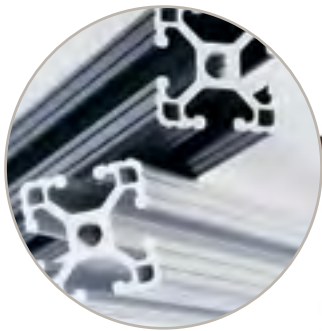

The anodized aluminum supports are the core of the extremely durable modular system.



Infinitely Adjustable Shelves

Removable Rear Panels allow easy access to components.

Premium Hardware

Passages for Wire Management

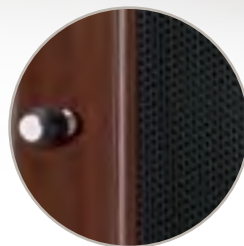

Optional, perforated door or glass inserts permit IR signals, add ventilation and mask speakers.



Snap-on hinges fully extend optional doors and remove easily for better in-cabinet access. All doors feature soft-close dampeners. (Doors sold separately.)

# SYNERGY<sup>®</sup>

## MODULAR SYSTEM

Synergy is all about configurability. It is a fully modular furniture system that takes customization to a whole new level. Combine various sized core and extension modules with enclosure elements to create a unique, personal piece of furniture. Or choose from a selection of pre-configured solutions that fits your needs.

### Core Modules

For use individually or with modules.

### Side Panels

Panels slide neatly between support posts enclosing exterior and interior of units.



### Extension Modules

Straight forward additions that make it easy to extend Synergy cabinets.



### Doors

Enclose any cabinet, fully or partially. Doors can be attached both from the left or right.



### Drawers

Enclose any cabinet, fully or partially.





# DESIGNING A SYNERGY SYSTEM

Personalize the appearance of the Synergy System by combining the finest material options. Choose wood finishes, posts, door inserts and side panels. The selection is all up to you.

## 1. Select a Core Module

Available in Single-Width (23.75"), Twin-Width (44"), Triple-Width (66.25") or Quad-Width (88") in 12", 21", 31" or 41" heights.

## 2. Add Extension Modules

Available in Single-Width (23.75"), Twin-Width (44"), Triple-Width (66.25") in 9.625", 19", 29", or 39" heights.

## 3. Enclose with Side Panels

Available in black, wood finishes, black perforated steel or tan suede.

## 4. Outfit with Doors

Solid wood framed with choice of frosted glass or black, perforated steel inserts.

## 5. Select Wood & Posts

Solid real wood veneers such as dark cherry, natural maple, dark walnut or black on MDF.

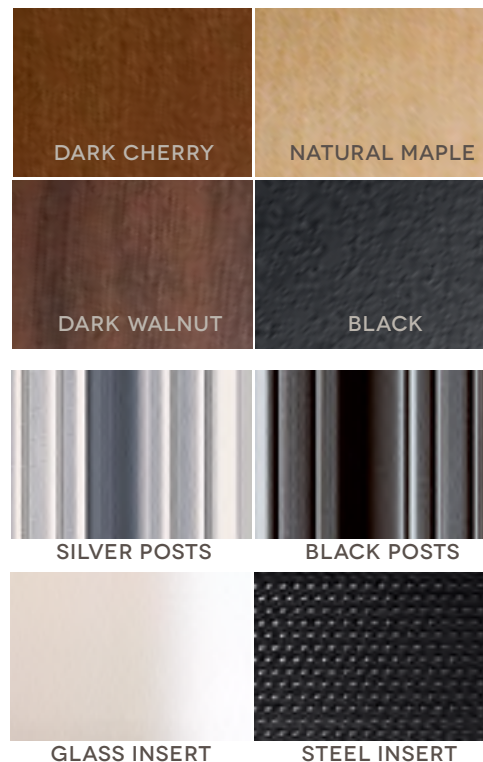

Our unique "Design Your Own" process uses an online Custom "Configurator" tool to help people build their own unique pieces of AV furniture. The Configurator lets anyone select the configuration and functional features that match exactly with their desired use. [www.salamanderdesigns.com](http://www.salamanderdesigns.com)



# SYNERGY SYSTEM

## SINGLE MODULES

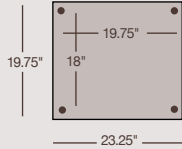

- Open Cabinets can be enclosed with Synergy Doors, Sides and Drawers.
- Infinitely Adjustable, Black Interior Shelves
- Removable Rear Panels provide easy component access.
- Heavy Duty, non-marking leveler feet are standard.
- Capacities:  
Top (1.125" thick) holds 150 lbs.  
Interior Shelves (3/4" thick) hold 75 lbs each  
(Heavy Duty Shelf Brackets hold up to 150 lbs)



Hold TV's  
up to 40"



Hold up to  
500 lbs

**RM** Rack Mount Model  
available, see page 58.

**W** Wall Mountable,  
see kit on page 81.

Speaker Integration

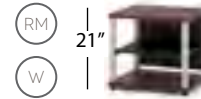

### Single 20 - Core Module

Black/Black	SU20B/B
Black/Aluminum	SU20B/A
Cherry/Black	SU20C/B
Cherry/Aluminum	SU20C/A
Maple/Black	SU20M/B
Maple/Aluminum	SU20M/A
Walnut/Black	SU20W/B
Walnut/Aluminum	SU20W/A

- 1 Adjustable Shelf



### Single 30 - Core Module

Black/Black	SU30B/B
Black/Aluminum	SU30B/A
Cherry/Black	SU30C/B
Cherry/Aluminum	SU30C/A
Maple/Black	SU30M/B
Maple/Aluminum	SU30M/A
Walnut/Black	SU30W/B
Walnut/Aluminum	SU30W/A

- 2 Adjustable Shelves with 1 Set of Heavy Duty Shelf Brackets (hold up to 150 lbs)

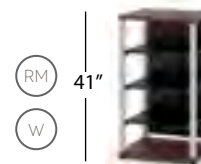

### Single 40 - Core Module

Black/Black	SU40B/B
Black/Aluminum	SU40B/A
Cherry/Black	SU40C/B
Cherry/Aluminum	SU40C/A
Maple/Black	SU40M/B
Maple/Aluminum	SU40M/A
Walnut/Black	SU40W/B
Walnut/Aluminum	SU40W/A

- 3 Adjustable Shelves with 1 Set of Heavy Duty Shelf Brackets (hold up to 150 lbs)



### Single 20 - Extension Module

Black/Black	SX20B/B
Black/Aluminum	SX20B/A
Cherry/Black	SX20C/B
Cherry/Aluminum	SX20C/A
Maple/Black	SX20M/B
Maple/Aluminum	SX20M/A
Walnut/Black	SX20W/B
Walnut/Aluminum	SX20W/A

- 1 Adjustable Shelf



### Single 30 - Extension Module

Black/Black	SX30B/B
Black/Aluminum	SX30B/A
Cherry/Black	SX30C/B
Cherry/Aluminum	SX30C/A
Maple/Black	SX30M/B
Maple/Aluminum	SX30M/A
Walnut/Black	SX30W/B
Walnut/Aluminum	SX30W/A

- 2 Adjustable Shelves with 1 Set of Heavy Duty Shelf Brackets (hold up to 150 lbs)

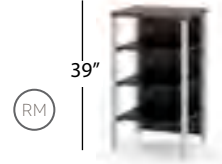

### Single 40 - Extension Module

Black/Black	SX40B/B
Black/Aluminum	SX40B/A
Cherry/Black	SX40C/B
Cherry/Aluminum	SX40C/A
Maple/Black	SX40M/B
Maple/Aluminum	SX40M/A
Walnut/Black	SX40W/B
Walnut/Aluminum	SX40W/A

- 3 Adjustable Shelves with 1 Set of Heavy Duty Shelf Brackets (hold up to 150 lbs)

## SIDES

- Choose matching side panels or mix wood sides with black, perforated steel sides to help keep equipment cool.
- Segregate bays with interior side panels (Quads order 2 sets, Triples order 1 set).
- Sold in sets of 2.



### Synergy 10 Sides

Black	SS10/B
Cherry	SS10/C
Maple	SS10/M
Walnut	SS10/W
Black Perforated Steel	SS10/P
Tan Suede Leather	SS10/L



### Synergy 20 Sides

Black	SS20/B
Cherry	SS20/C
Maple	SS20/M
Walnut	SS20/W
Black Perforated Steel	SS20/P
Tan Suede Leather	SS20/L

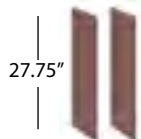

### Synergy 30 Sides

Black	SS30/B
Cherry	SS30/C
Maple	SS30/M
Walnut	SS30/W
Black Perforated Steel	SS30/P
Tan Suede Leather	SS30/L



### Synergy 40 Sides

Black	SS40/B
Cherry	SS40/C
Maple	SS40/M
Walnut	SS40/W
Black Perforated Steel	SS40/P
Tan Suede Leather	SS40/L

## DOORS

- Can be attached to open from left or right.
- Permit Infra-red signals.
- Perforated steel panels keep equipment cool and conceal speakers.
- Door lock compatible with all doors.
- Solid hardwood frames with insert panels.
- Machined aluminum with black rubber door pull.



### Synergy 10 Doors

Black/Perforated Steel	SD10B/P
Black/Frosted Glass	SD10B/G
Cherry/Perforated Steel	SD10C/P
Cherry/Frosted Glass	SD10C/G
Maple/Perforated Steel	SD10M/P
Maple/Frosted Glass	SD10M/G
Walnut/Perforated Steel	SD10W/P
Walnut/Frosted Glass	SD10W/G

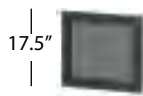

### Synergy 20 Doors

Black/Perforated Steel	SD20B/P
Black/Frosted Glass	SD20B/G
Cherry/Perforated Steel	SD20C/P
Cherry/Frosted Glass	SD20C/G
Maple/Perforated Steel	SD20M/P
Maple/Frosted Glass	SD20M/G
Walnut/Perforated Steel	SD20W/P
Walnut/Frosted Glass	SD20W/G



### Synergy 30 Doors

Black/Perforated Steel	SD30B/P
Black/Frosted Glass	SD30B/G
Cherry/Perforated Steel	SD30C/P
Cherry/Frosted Glass	SD30C/G
Maple/Perforated Steel	SD30M/P
Maple/Frosted Glass	SD30M/G
Walnut/Perforated Steel	SD30W/P
Walnut/Frosted Glass	SD30W/G



## DRAWERS

- Metal sided with solid hardwood face.



### Synergy Drawers

Black	SA/MD/B
Cherry	SA/MD/C
Maple	SA/MD/M
Walnut	SA/MD/W

#### • CANNOT BE PLACED BEHIND DOORS.

- Interior Dimensions: 18.375"W x 6"H x 15.75"D
- Exterior Dimensions: 19.5"W x 6.75"H x 17.5"D
- Load Capacity: 100 lbs.
- Capacity: 102 CD's or 52 DVD



### Synergy Door Locks

DYI Door Lock Kit	SD/LOCK
Factory Installed Door Lock Kit	F/SD/LOCK

- The Synergy Door Lock Kit allows you to add a lock to any Synergy Door.
- DYI kit requires drilling, bit included.

### Synergy 40 Doors

Black/Perforated Steel	SD40B/P
Black/Frosted Glass	SD40B/G
Cherry/Perforated Steel	SD40C/P
Cherry/Frosted Glass	SD40C/G
Maple/Perforated Steel	SD40M/P
Maple/Frosted Glass	SD40M/G
Walnut/Perforated Steel	SD40W/P
Walnut/Frosted Glass	SD40W/G



# SYNERGY SYSTEM

## TWIN CORE MODULES

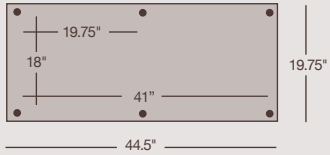

- Open Cabinets can be enclosed with Synergy Doors, Sides and Drawers.
- Infinitely Adjustable, Black Interior Shelves
- Removable Rear Panels provide easy component access.
- Heavy Duty, non-marking leveler feet are standard.
- Capacities:
  - Top (1.125" thick) holds 250 lbs.
  - Interior Shelves (3/4" thick) hold 75 lbs each (Heavy Duty Shelf Brackets hold up to 150 lbs)



Hold TV's  
up to 50"



Hold up to  
750 lbs

Rack Mount Model available, see page 58.

Wall Mountable, see kit on page 81.

Speaker Integration



### Twin 10 - Core Module

Black/Black	SN10B/B
Black/Aluminum	SN10B/A
Cherry/Black	SN10C/B
Cherry/Aluminum	SN10C/A
Maple/Black	SN10M/B
Maple/Aluminum	SN10M/A
Walnut/Black	SN10W/B
Walnut/Aluminum	SN10W/A

- DOES NOT include adjustable shelves.



### Twin 20 - Core Module

Black/Black	SN20B/B
Black/Aluminum	SN20B/A
Cherry/Black	SN20C/B
Cherry/Aluminum	SN20C/A
Maple/Black	SN20M/B
Maple/Aluminum	SN20M/A
Walnut/Black	SN20W/B
Walnut/Aluminum	SN20W/A

- Includes 2 adjustable shelves.



### Twin 30 - Core Module

Black/Black	SN30B/B
Black/Aluminum	SN30B/A
Cherry/Black	SN30C/B
Cherry/Aluminum	SN30C/A
Maple/Black	SN30M/B
Maple/Aluminum	SN30M/A
Walnut/Black	SN30W/B
Walnut/Aluminum	SN30W/A

- Includes 4 adjustable shelves with 2 Sets of Heavy Duty Shelf Brackets (hold up to 150 lbs)

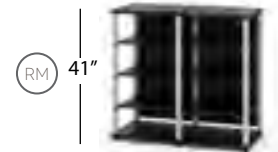

### Twin 40 - Core Module

Black/Black	SN40B/B
Black/Aluminum	SN40B/A
Cherry/Black	SN40C/B
Cherry/Aluminum	SN40C/A
Maple/Black	SN40M/B
Maple/Aluminum	SN40M/A
Walnut/Black	SN40W/B
Walnut/Aluminum	SN40W/A

- Includes 8 adjustable shelves with 2 sets of heavy duty shelf brackets (hold up to 150 lbs)



### Twin 20 Open Center - Core Module

Black/Black	SNC20B/B
Black/Aluminum	SNC20B/A
Cherry/Black	SNC20C/B
Cherry/Aluminum	SNC20C/A
Maple/Black	SNC20M/B
Maple/Aluminum	SNC20M/A
Walnut/Black	SNC20W/B
Walnut/Aluminum	SNC20W/A

- Top Holds a Maximum of 200 lbs.
- Twin-Width Center Opening: 41"W x 8.5"H x 17.5"D
- Bottom 2 Bays: 19.75"W x 8.5"H x 18"D
- Bottom Bays accommodate Synergy 10 Doors (see page 51)



### Twin 30 Open Center - Core Module

Black/Black	SNC30B/B
Black/Aluminum	SNC30B/A
Cherry/Black	SNC30C/B
Cherry/Aluminum	SNC30C/A
Maple/Black	SNC30M/B
Maple/Aluminum	SNC30M/A
Walnut/Black	SNC30W/B
Walnut/Aluminum	SNC30W/A

- Top Holds a Maximum of 200 lbs.
- Twin-Width Center Opening: 41"W x 8.5"H x 17.5"D
- Bottom 2 Bays: 19.75"W x 17.75"H x 18"D, 2 Adjustable Shelves
- Bottom Bays accommodate Synergy 20 Doors (see page 51)

# SYNERGY SYSTEM TWIN RISERS & EXTENSIONS



## Twin 20 - Extension Module

Black/Black	SNX20B/B
Black/Aluminum	SNX20B/A
Cherry/Black	SNX20C/B
Cherry/Aluminum	SNX20C/A
Maple/Black	SNX20M/B
Maple/Aluminum	SNX20M/A
Walnut/Black	SNX20W/B
Walnut/Aluminum	SNX20W/A

- Includes 2 adjustable shelves.



## Twin 30 - Extension Module

Black/Black	SNX30B/B
Black/Aluminum	SNX30B/A
Cherry/Black	SNX30C/B
Cherry/Aluminum	SNX30C/A
Maple/Black	SNX30M/B
Maple/Aluminum	SNX30M/A
Walnut/Black	SNX30W/B
Walnut/Aluminum	SNX30W/A

- Includes 4 adjustable shelves with 2 Sets of Heavy Duty Shelf Brackets (hold up to 150 lbs)



## Twin 40 - Extension Module

Black/Black	SNX40B/B
Black/Aluminum	SNX40B/A
Cherry/Black	SNX40C/B
Cherry/Aluminum	SNX40C/A
Maple/Black	SNX40M/B
Maple/Aluminum	SNX40M/A
Walnut/Black	SNX40W/B
Walnut/Aluminum	SNX40W/A

- Includes 6 adjustable shelves and 2 sets of heavy duty shelf brackets (hold up to 150 lbs.).



## Twin 10 - Riser Module

Black with 8.5" Black Post	SNRB/B
Black with 8.5" Aluminum Post	SNRB/A
Cherry with 8.5" Black Post	SNRC/B
Cherry with 8.5" Aluminum Post	SNRC/A
Maple with 8.5" Black Post	SNRM/B
Maple with 8.5" Aluminum Post	SNRM/A
Walnut with 8.5" Black Post	SNRW/B
Walnut with 8.5" Aluminum Post	SNRW/A

- \* Top Holds a Maximum of 200 lbs.
- Interior: 41"W x 8.5"H x 17.5"D



## Twin Custom Cut - Riser Module

Black/Black	SNRXB/B
Black/Aluminum	SNRXB/A
Cherry/Black	SNRXC/B
Cherry/Aluminum	SNRXC/A
Maple/Black	SNRXM/B
Maple/Aluminum	SNRXM/A
Walnut/Black	SNRXW/B
Walnut/Aluminum	SNRXW/A

- \* Top Holds a Maximum of 200 lbs.
- Includes custom cut rear panels.
- MUST specify a post height when ordering, 3 - 17.75" in increments of 1/4".
- Please allow for 1/16" tolerance.



## Custom Cut Side Panels for Riser

Black	SSX20/B
Cherry	SSX20/C
Maple	SSX20/M
Walnut	SSX20/W
Tan Suede Leather	SSX20/L

- MUST specify a post height when ordering, 3 - 17.75" in increments of 1/4".
- Please allow for 1/16" tolerance.

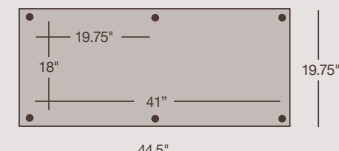

- Open Cabinets can be enclosed with Synergy Doors, Sides and Drawers.
- Infinitely Adjustable, Black Interior Shelves
- Attach to Any Synergy Twin Core Module
- Removable Rear Panels provide easy component access.
- Removable Rear Panels provide easy component access.
- Capacities:  
Top (1.125" thick) holds 350 lbs.  
Interior Shelves (3/4" thick) hold 75 lbs each



Hold TV's  
up to 50"



Hold up to  
750 lbs



Rack Mount Model  
Available, See page 58.



Speaker Integration

built on







# SYNERGY SYSTEM

## TRIPLE CORE MODULES

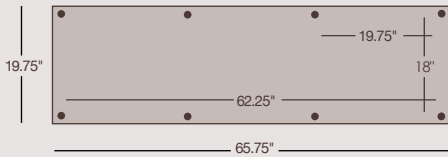

- Open Cabinets can be enclosed with Synergy Doors, Sides and Drawers.
- Removable Rear Panels provide easy component access.
- Heavy Duty, non-marking leveler feet are standard.
- Segregate Bays with 2 Interior Side Panels
- Capacities:
  - Top (1.125" thick) holds 350 lbs.
  - Interior Shelves (3/4" thick) hold 75 lbs each (Heavy Duty Shelf Brackets hold up to 150 lbs)



Hold TV's up to 75"



Hold up to 1000 lbs



Rack Mount Model available, see page 58.



Wall Mountable, see kit on page 81.



Speaker Integration

built on



12"



### Triple 10 - Core Module

Black/Black	SL10B/B
Black/Aluminum	SL10B/A
Cherry/Black	SL10C/B
Cherry/Aluminum	SL10C/A
Maple/Black	SL10M/B
Maple/Aluminum	SL10M/A
Walnut/Black	SL10W/B
Walnut/Aluminum	SL10W/A

- DOES NOT include adjustable shelves.



21"



### Triple 20 - Core Module

Black/Black	SL20B/B
Black/Aluminum	SL20B/A
Cherry/Black	SL20C/B
Cherry/Aluminum	SL20C/A
Maple/Black	SL20M/B
Maple/Aluminum	SL20M/A
Walnut/Black	SL20W/B
Walnut/Aluminum	SL20W/A

- Includes 3 adjustable shelves.



31"



### Triple 30 - Core Module

Black/Black	SL30B/B
Black/Aluminum	SL30B/A
Cherry/Black	SL30C/B
Cherry/Aluminum	SL30C/A
Maple/Black	SL30M/B
Maple/Aluminum	SL30M/A
Walnut/Black	SL30W/B
Walnut/Aluminum	SL30W/A

- Includes 6 adjustable shelves with 3 Set of Heavy Duty Shelf Brackets (hold up to 150 lbs).



41"

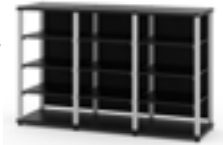

### Triple 40 - Core Module

Black/Black	SL40B/B
Black/Aluminum	SL40B/A
Cherry/Black	SL40C/B
Cherry/Aluminum	SL40C/A
Maple/Black	SL40M/B
Maple/Aluminum	SL40M/A
Walnut/Black	SL40W/B
Walnut/Aluminum	SL40W/A

- Includes 9 adjustable shelves with 3 sets of heavy duty shelf brackets (hold up to 150 lbs)



21"



### Triple 20 Open Center - Core Module

Black/Black	SLC20B/B
Black/Aluminum	SLC20B/A
Cherry/Black	SLC20C/B
Cherry/Aluminum	SLC20C/A
Maple/Black	SLC20M/B
Maple/Aluminum	SLC20M/A
Walnut/Black	SLC20W/B
Walnut/Aluminum	SLC20W/A

- \*Top Holds a Maximum of 150 lbs.
- Triple-Width Center Opening: 62.25"W x 7.5"H x 17.5"
- Bottom 3 Bays: 19.75"W x 8.5"H x 18"D
- Bottom Bays accommodate Synergy 10 Doors (see page 51)



31"



### Triple 30 Open Center - Core Module

Black/Black	SLC30B/B
Black/Aluminum	SLC30B/A
Cherry/Black	SLC30C/B
Cherry/Aluminum	SLC30C/A
Maple/Black	SLC30M/B
Maple/Aluminum	SLC30M/A
Walnut/Black	SLC30W/B
Walnut/Aluminum	SLC30W/A

- Top Holds a Maximum of 150 lbs.
- Triple-Width Center Opening: 62.25"W x 8.25"H x 17.5"
- Bottom 3 Bays: 19.75"W x 17.75"H x 18"D, 3 Adjustable Shelves
- Bottom Bays accommodate Synergy 20 Doors (see page 51)



**Triple 20 - Extension Module**

Black/Black	SLX20B/B
Black/Aluminum	SLX20B/A
Cherry/Black	SLX20C/B
Cherry/Aluminum	SLX20C/A
Maple/Black	SLX20M/B
Maple/Aluminum	SLX20M/A
Walnut/Black	SLX20W/B
Walnut/Aluminum	SLX20W/A

- Includes 3 adjustable shelves.



**Triple 10 - Riser Module**

Black/Black	SLRB/A
Black/Aluminum	SLRB/A
Cherry/Black	SLRC/B
Cherry/Aluminum	SLRC/A
Maple/Black	SLRM/B
Maple/Aluminum	SLRM/A
Walnut/Black	SLRW/B
Walnut/Aluminum	SLRW/A

- \* Top Holds a Maximum of 125 lbs.
- Interior: 62.25"W x 8.5"H x 17.5"D



**Triple Custom Cut - Riser Module**

Black/Black	SLRXB/B
Black/Aluminum	SLRXB/A
Cherry/Black	SLRXC/B
Cherry/Aluminum	SLRXC/A
Maple/Black	SLRXM/B
Maple/Aluminum	SLRXM/A
Walnut/Black	SLRXW/B
Walnut/Aluminum	SLRXW/A

- \* Top Holds a Maximum of 125 lbs.
- Includes custom cut rear panels.
- MUST specify a post height when ordering, 3 - 17.75" in increments of 1/4".
- Please allow for 1/16" tolerance.



**Custom Cut Side Panels for Riser**

Black	SSX20/B
Cherry	SSX20/C
Maple	SSX20/M
Walnut	SSX20/W
Tan Suede Leather	SSX20/L

- MUST specify a post height when ordering, 3 - 17.75" in increments of 1/4".
- Please allow for 1/16" tolerance.



**Triple 30 - Extension Module**

Black/Black	SLX30B/B
Black/Aluminum	SLX30B/A
Cherry/Black	SLX30C/B
Cherry/Aluminum	SLX30C/A
Maple/Black	SLX30M/B
Maple/Aluminum	SLX30M/A
Walnut/Black	SLX30W/B
Walnut/Aluminum	SLX30W/A

- Includes 6 adjustable shelves with 3 sets of heavy duty shelf brackets (hold up to 150 lbs)



**Triple 40 - Wall Module**

Black/Black	SLW40B/B
Black/Aluminum	SLW40B/A
Cherry/Black	SLW40C/B
Cherry/Aluminum	SLW40C/A
Maple/Black	SLW40M/B
Maple/Aluminum	SLW40M/A
Walnut/Black	SLW40W/B
Walnut/Aluminum	SLW40W/A

- \* Top Holds a Maximum of 200 lbs.
- Includes black, perforated steel side panels and black, rear panels.
- Accommodates Glass Center Speaker Shelf (see page 75).
- Center two back posts are finished in black.
- Wall Interior 37.75" H x 62.25" W
- Accommodates Integrated Wall mounts (see page 109).



**Triple 10 - Hutch Module**

Black/Black	SLH10B/B
Black/Aluminum	SLH10B/A
Cherry/Black	SLH10C/B
Cherry/Aluminum	SLH10C/A
Maple/Black	SLH10M/B
Maple/Aluminum	SLH10M/A
Walnut/Black	SLH10W/B
Walnut/Aluminum	SLH10W/A

- \* Top Holds a Maximum of 100 lbs.
- Includes matching wood side panels and black, rear panels.
- Enclose with Synergy 10 Doors (see page 51).

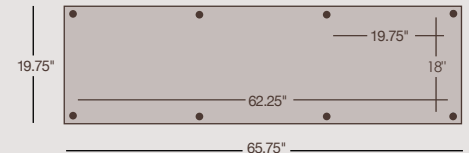

- Open Cabinets can be enclosed with Synergy Doors, Sides and Drawers.
- Infinitely Adjustable, Black Interior Shelves
- Attach to Any Synergy Triple Core Module
- Segregate Bays with 1 Interior Side Panel
- Removable Rear Panels provide easy component access.
- Capacities:  
 Top (1.125" thick) holds 350 lbs.  
 Interior Shelves (3/4" thick) hold 75 lbs each  
 (Heavy Duty Shelf Brackets hold up to 150 lbs)



Hold TV's up to 75"



Hold up to 1000 lbs



Rack Mount Model Available, See page 58.



Speaker Integration

built on





# SYNERGY SYSTEM QUAD MODULES

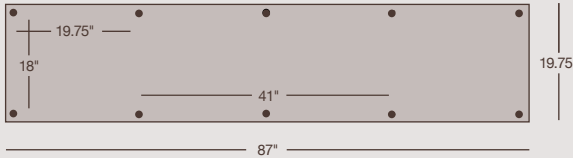

- Open Cabinets can be enclosed with Synergy Doors, Sides and Drawers.
- Removable Rear Panels provide easy component access.
- Heavy Duty, non-marking leveler feet are standard.
- Segregate Bays with 1 Interior Side Panel
- Capacities:
  - Top (1.125" thick) holds 350 lbs.
  - Interior Shelves (3/4" thick) hold 75 lbs each (Heavy Duty Shelf Brackets hold up to 150 lbs)



Hold TV's  
up to 90"



Hold up to  
1000 lbs



Wall Mountable,  
see kit on page 81.



Speaker Integration

built on



W 12"



### Quad 10 - Core Module

Black/Black	SQ10B/B
Black/Aluminum	SQ10B/A
Cherry/Black	SQ10C/B
Cherry/Aluminum	SQ10C/A
Maple/Black	SQ10M/B
Maple/Aluminum	SQ10M/A
Walnut/Black	SQ10W/B
Walnut/Aluminum	SQ10W/A

- DOES NOT include adjustable shelves.

W 21"



### Quad 20 - Core Module

Black/Black	SQ20B/B
Black/Aluminum	SQ20B/A
Cherry/Black	SQ20C/B
Cherry/Aluminum	SQ20C/A
Maple/Black	SQ20M/B
Maple/Aluminum	SQ20M/A
Walnut/Black	SQ20W/B
Walnut/Aluminum	SQ20W/A

- Includes 4 adjustable shelves.

W 21"



### Quad 20 Open Center - Core Module

Black/Black	SQC20B/B
Black/Aluminum	SQC20B/A
Cherry/Black	SQC20C/B
Cherry/Aluminum	SQC20C/A
Maple/Black	SQC20M/B
Maple/Aluminum	SQC20M/A
Walnut/Black	SQC20W/B
Walnut/Aluminum	SQC20W/A

- Includes 2 adjustable shelves.

W 31"



### Quad 30 - Core Module

Black/Black	SQ30B/B
Black/Aluminum	SQ30B/A
Cherry/Black	SQ30C/B
Cherry/Aluminum	SQ30C/A
Maple/Black	SQ30M/B
Maple/Aluminum	SQ30M/A
Walnut/Black	SQ30W/B
Walnut/Aluminum	SQ30W/A

- Includes 8 adjustable shelves with 4 sets of heavy duty shelf brackets (hold up to 150 lbs)

W 31"



### Quad 30 Open Center- Core Module

Black/Black	SQC30B/B
Black/Aluminum	SQC30B/A
Cherry/Black	SQC30C/B
Cherry/Aluminum	SQC30C/A
Maple/Black	SQC30M/B
Maple/Aluminum	SQC30M/A
Walnut/Black	SQC30W/B
Walnut/Aluminum	SQC30W/A

- Includes 8 adjustable shelves.

12"



60"

### Quad 40 - Wall Module

Black/Black	SQW40B/B
Black/Aluminum	SQW40B/A
Cherry/Black	SQW40C/B
Cherry/Aluminum	SQW40C/A
Maple/Black	SQW40M/B
Maple/Aluminum	SQW40M/A
Walnut/Black	SQW40W/B
Walnut/Aluminum	SQW40W/A

- \* Top Holds a Maximum of 200 lbs.
- Includes black, perforated steel side panels and black, rear panels.
- Center three back posts are finished in black.
- Wall Interior 37.75" H x 83.5" W
- Accommodates Integrated Wall mounts (see page 109).

12"  
9.625"



70"

### Quad 10 - Hutch Module

Black/Black	SQH10B/B
Black/Aluminum	SQH10B/A
Cherry/Black	SQH10C/B
Cherry/Aluminum	SQH10C/A
Maple/Black	SQH10M/B
Maple/Aluminum	SQH10M/A
Walnut/Black	SQH10W/B
Walnut/Aluminum	SQH10W/A

- \* Top Holds a Maximum of 100 lbs.
- Includes matching wood side panels and black rear panels.
- Enclose with Synergy 10 Doors (see page 51).

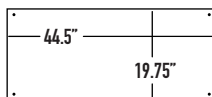

### Synergy Bridge Three

Black	SB3/B
Cherry	SB3/C
Maple	SB3/M
Walnut	SB3/W

- Holds TV's Up To 46".
- Total Maximum Weight Capacity: 100 lbs.
- 46" Maximum Width with Brackets Fully Extended
- 1.125" Thick

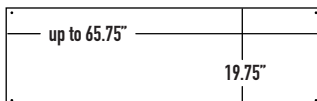

### Synergy Custom Cut Bridge

Black	SBX/B
Cherry	SBX/C
Maple	SBX/M
Walnut	SBX/W

- Must provide actual TV width and we add 1" for clearance (67.75" Max.)
- Total Maximum Weight Capacity: 100 lbs.
- 1.125" Thick

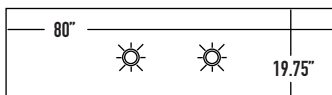

### Synergy Plank Bridge with Lights

Black	SBP/B
Cherry	SBP/C
Maple	SBP/M
Walnut	SBP/W

- Rests on top of two Synergy towers and spans TV's up to 72".
- Includes recessed puck lights.
- Total Maximum Weight Capacity: 150 lbs.
- 2.5" Thick
- *While supplies last.*



### Synergy Amplifier Stand

Black	SAMP/B
Cherry	SAMP/C
Maple	SAMP/M
Walnut	SAMP/W

- Total Maximum Weight Capacity: 250 lbs.
- Includes 3" Polished Aluminum Claw Feet
- 23.25" x 19.75" x 4.5"



### Synergy Media Storage Cabinet

Black/Black	SMS40B/B
Black/Aluminum	SMS40B/A
Cherry/Black	SMS40C/B
Cherry/Aluminum	SMS40C/A
Maple/Black	SMS40M/B
Maple/Aluminum	SMS40M/A
Walnut/Black	SMS40W/B
Walnut/Aluminum	SMS40W/A

- Includes 4 adjustable height and angle shelves and matching wood sides.
- Includes 2 stops.
- Capacity: 200 CD's, 108 DVD's.
- Accepts a 40" Door and Lock (See Page 82).



### Synergy Media Cabinet Shelf

Bronze	SMS1
--------	------

- Cabinet will allow for one additional shelf ONLY when used for CD's.
- Capacity: 50 CD's or 27 DVD's.





# SYNERGY™

## PRO AUDIO MODULAR RACKS



A fully modular pro audio system that takes customization to a whole new level. A virtually limitless number of configurations and an extensive range of accessories allow you to create highly personalized Pro Audio racks and cabinets with premium components that will deliver exceptional reliability and durability. Mounts are compatible with industry standard, EIA 19" components.

The anodized aluminum supports are the core of the extremely durable modular system.

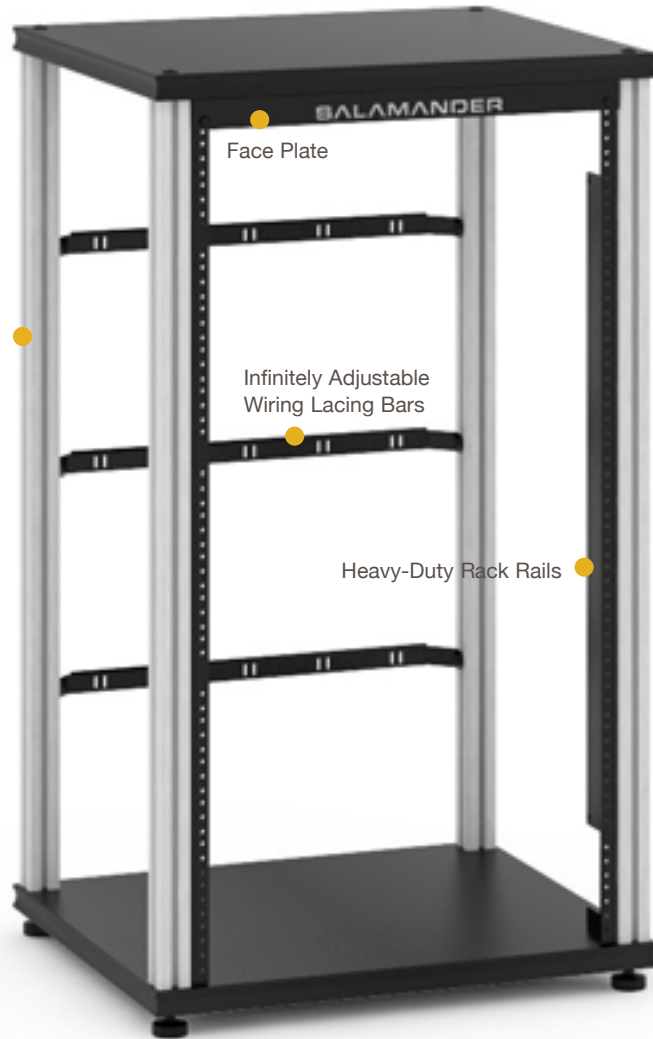

Model	Rack Units	Top Capacity	Maximum Capacity
SINGLE 20	10	150 lbs.	500 lbs.
SINGLE 30	15	150 lbs.	500 lbs.
SINGLE 40	21	150 lbs.	500 lbs.
TWIN 20	20	250 lbs.	750 lbs.
TWIN 30	30	250 lbs.	750 lbs.
TWIN 40	42	250 lbs.	750 lbs.
TRIPLE 20	30	350 lbs.	1000 lbs.
TRIPLE 30	45	350 lbs.	1000 lbs.
TRIPLE 40	63	350 lbs.	1000 lbs.

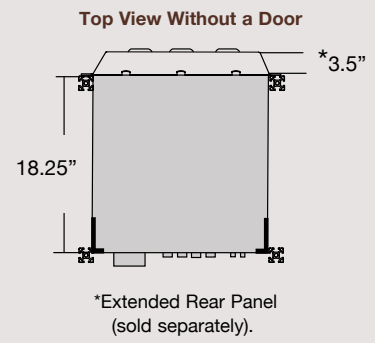
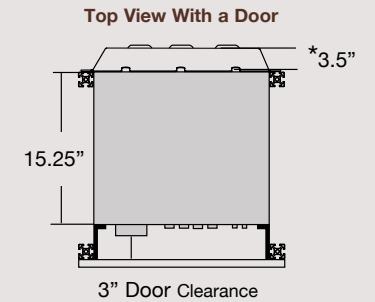



21"

### Single 20 Rack Mount - Core Module

Black/Black	SU20RMB/B
Black/Aluminum	SU20RMB/A
Cherry/Black	SU20RMC/B
Cherry/Aluminum	SU20RMC/A
Maple/Black	SU20RMM/B
Maple/Aluminum	SU20RMM/A
Walnut/Black	SU20RMW/B
Walnut/Aluminum	SU20RMW/A

- Holds up to 10 U's.
- Includes 1 Lacing Bar



31"

### Single 30 Rack Mount - Core Module

Black/Black	SU30RMB/B
Black/Aluminum	SU30RMB/A
Cherry/Black	SU30RMC/B
Cherry/Aluminum	SU30RMC/A
Maple/Black	SU30RMM/B
Maple/Aluminum	SU30RMM/A
Walnut/Black	SU30RMW/B
Walnut/Aluminum	SU30RMW/A

- Holds up to 15 U's.
- Includes 2 Lacing Bars



41"

### Single 40 Rack Mount - Core Module

Black/Black	SU40RMB/B
Black/Aluminum	SU40RMB/A
Cherry/Black	SU40RMC/B
Cherry/Aluminum	SU40RMC/A
Maple/Black	SU40RMM/B
Maple/Aluminum	SU40RMM/A
Walnut/Black	SU40RMW/B
Walnut/Aluminum	SU40RMW/A

- Holds up to 21 U's.
- Includes 3 Lacing Bars



19"

### Single 20 Rack Mount - Extension Module

Black/Black	SX20RMB/B
Black/Aluminum	SX20RMB/A
Cherry/Black	SX20RMC/B
Cherry/Aluminum	SX20RMC/A
Maple/Black	SX20RMM/B
Maple/Aluminum	SX20RMM/A
Walnut/Black	SX20RMW/B
Walnut/Aluminum	SX20RMW/A

- Holds up to 10 U's.
- Includes 1 Lacing Bar



29"

### Single 30 Rack Mount - Extension Module

Black/Black	SX30RMB/B
Black/Aluminum	SX30RMB/A
Cherry/Black	SX30RMC/B
Cherry/Aluminum	SX30RMC/A
Maple/Black	SX30RMM/B
Maple/Aluminum	SX30RMM/A
Walnut/Black	SX30RMW/B
Walnut/Aluminum	SX30RMW/A

- Holds up to 15 U's.
- Includes 2 Lacing Bars



39"

### Single 40 Rack Mount - Extension Module

Black/Black	SX40RMB/B
Black/Aluminum	SX40RMB/A
Cherry/Black	SX40RMC/B
Cherry/Aluminum	SX40RMC/A
Maple/Black	SX40RMM/B
Maple/Aluminum	SX40RMM/A
Walnut/Black	SX40RMW/B
Walnut/Aluminum	SX40RMW/A

- Holds up to 21 U's.
- Includes 3 Lacing Bars

built on

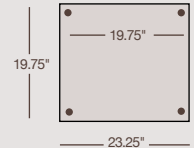

- Heavy duty rack rails.
- Open modules can be enclosed with Doors and Sides
- Rear wire lacing bars included. No rear panel.
- Heavy Duty, non-marking leveler feet are standard.
- Top (1.125" thick) holds 150 lbs.
- Faceplate included.
- Optional Rack Rails may be added to the rear.



Hold TV's  
up to 40"



Hold up to  
500 lbs

### Wire Management See page 77 for Accessories.





# SYNERGY SYSTEM

## TWIN PRO AUDIO MODULES

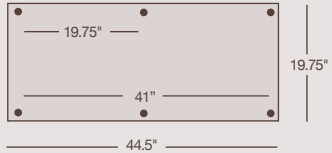

- Heavy duty rack rails.
- Open modules can be enclosed with Doors and Sides
- Rear wire lacing bars included. No rear panels.
- Heavy Duty, non-marking leveler feet are standard.
- Top (1.125" thick) holds 250 lbs.
- Faceplate included.



Hold TV's  
up to 50"



Hold up to  
750 lbs

### Vented Rack Mount Shelves

See page 77 for Accessories.



21"

### Twin 20 Rack Mount - Core Module

Black/Black	SN20RMB/B
Black/Aluminum	SN20RMB/A
Cherry/Black	SN20RMC/B
Cherry/Aluminum	SN20RMC/A
Maple/Black	SN20RMM/B
Maple/Aluminum	SN20RMM/A
Walnut/Black	SN20RMW/B
Walnut/Aluminum	SN20RMW/A

- Holds up to 20 U's.
- Includes 2 Lacing Bars



31"

### Twin 30 Rack Mount - Core Module

Black/Black	SN30RMB/B
Black/Aluminum	SN30RMB/A
Cherry/Black	SN30RMC/B
Cherry/Aluminum	SN30RMC/A
Maple/Black	SN30RMM/B
Maple/Aluminum	SN30RMM/A
Walnut/Black	SN30RMW/B
Walnut/Aluminum	SN30RMW/A

- Holds up to 30 U's.
- Includes 4 Lacing Bars



41"

### Twin 40 Rack Mount - Core Module

Black/Black	SN40RMB/B
Black/Aluminum	SN40RMB/A
Cherry/Black	SN40RMC/B
Cherry/Aluminum	SN40RMC/A
Maple/Black	SN40RMM/B
Maple/Aluminum	SN40RMM/A
Walnut/Black	SN40RMW/B
Walnut/Aluminum	SN40RMW/A

- Holds up to 42 U's.
- Includes 6 Lacing Bars

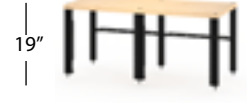

19"

### Twin 20 Rack Mount - Extension Module

Black/Black	SNX20RMB/B
Black/Aluminum	SNX20RMB/A
Cherry/Black	SNX20RMC/B
Cherry/Aluminum	SNX20RMC/A
Maple/Black	SNX20RMM/B
Maple/Aluminum	SNX20RMM/A
Walnut/Black	SNX20RMW/B
Walnut/Aluminum	SNX20RMW/A

- Holds up to 20 U's.
- Includes 2 Lacing Bars



29"

### Twin 30 Rack Mount - Extension Module

Black/Black	SNX30RMB/B
Black/Aluminum	SNX30RMB/A
Cherry/Black	SNX30RMC/B
Cherry/Aluminum	SNX30RMC/A
Maple/Black	SNX30RMM/B
Maple/Aluminum	SNX30RMM/A
Walnut/Black	SNX30RMW/B
Walnut/Aluminum	SNX30RMW/A

- Holds up to 30 U's.
- Includes 4 Lacing Bars



39"

### Twin 40 Rack Mount - Extension Module

Black/Black	SNX40RMB/B
Black/Aluminum	SNX40RMB/A
Cherry/Black	SNX40RMC/B
Cherry/Aluminum	SNX40RMC/A
Maple/Black	SNX40RMM/B
Maple/Aluminum	SNX40RMM/A
Walnut/Black	SNX40RMW/B
Walnut/Aluminum	SNX40RMW/A

- Holds up to 42 U's.
- Includes 6 Lacing Bars



# TRIPLE PRO AUDIO MODULES



## Triple 20 Rack Mount - Core Module

Black/Black	SL20RMB/B
Black/Aluminum	SL20RMB/A
Cherry/Black	SL20RMC/B
Cherry/Aluminum	SL20RMC/A
Maple/Black	SL20RMM/B
Maple/Aluminum	SL20RMM/A
Walnut/Black	SL20RMW/B
Walnut/Aluminum	SL20RMW/A

- Holds up to 30 U's.
- Includes 3 Lacing Bars



## Triple 30 Rack Mount - Core Module

Black/Black	SL30RMB/B
Black/Aluminum	SL30RMB/A
Cherry/Black	SL30RMC/B
Cherry/Aluminum	SL30RMC/A
Maple/Black	SL30RMM/B
Maple/Aluminum	SL30RMM/A
Walnut/Black	SL30RMW/B
Walnut/Aluminum	SL30RMW/A

- Holds up to 45 U's.
- Includes 6 Lacing Bars



## Triple 40 Rack Mount - Core Module

Black/Black	SL40RMB/B
Black/Aluminum	SL40RMB/A
Cherry/Black	SL40RMC/B
Cherry/Aluminum	SL40RMC/A
Maple/Black	SL40RMM/B
Maple/Aluminum	SL40RMM/A
Walnut/Black	SL40RMW/B
Walnut/Aluminum	SL40RMW/A

- Holds up to 63 U's.
- Includes 9 Lacing Bars



## Triple 20 Rack Mount - Extension Module

Black/Black	SLX20RMB/B
Black/Aluminum	SLX20RMB/A
Cherry/Black	SLX20RMC/B
Cherry/Aluminum	SLX20RMC/A
Maple/Black	SLX20RMM/B
Maple/Aluminum	SLX20RMM/A
Walnut/Black	SLX20RMW/B
Walnut/Aluminum	SLX20RMW/A

- Holds up to 30 U's.
- Includes 3 Lacing Bars



## Triple 30 Rack Mount - Extension Module

Black/Black	SLX30RMB/B
Black/Aluminum	SLX30RMB/A
Cherry/Black	SLX30RMC/B
Cherry/Aluminum	SLX30RMC/A
Maple/Black	SLX30RMM/B
Maple/Aluminum	SLX30RMM/A
Walnut/Black	SLX30RMW/B
Walnut/Aluminum	SLX30RMW/A

- Holds up to 45 U's.
- Includes 6 Lacing Bars



## Triple 40 Rack Mount - Extension Module

Black/Black	SLX40RMB/B
Black/Aluminum	SLX40RMB/A
Cherry/Black	SLX40RMC/B
Cherry/Aluminum	SLX40RMC/A
Maple/Black	SLX40RMM/B
Maple/Aluminum	SLX40RMM/A
Walnut/Black	SLX40RMW/B
Walnut/Aluminum	SLX40RMW/A

- Holds up to 63 U's.
- Includes 9 Lacing Bars



- Heavy duty rack rails.
- Open modules can be enclosed with Doors and Sides
- Rear wire lacing bars included. No rear panels.
- Heavy Duty, non-marking leveler feet are standard.
- Top (1.125" thick) holds 350 lbs.
- Faceplate included.



Hold TV's  
up to 75"



Hold up to  
1000 lbs



## Vented Rack Mount Face Plates

See page 77 for Accessories.





# SYNERGY™

## PRE-CONFIGURED SOLUTIONS

AVAILABLE IN: WALNUT, BLACK, CHERRY & MAPLE  
WITH BLACK PERFORATED STEEL DOORS



### Synergy Single 303

Black/Black	SB303B/B
Black/Aluminum	SB303B/A
Cherry/Black	SB303C/B
Cherry/Aluminum	SB303C/A
Maple/Black	SB303M/B
Maple/Aluminum	SB303M/A
Walnut/Black	SB303W/B
Walnut/Aluminum	SB303W/A

23.25"w x 31"h x 19.75"d  
• 3 Adjustable Shelves



### Synergy Single 402

Black/Black	SB402B/B
Black/Aluminum	SB402B/A
Cherry/Black	SB402C/B
Cherry/Aluminum	SB402C/A
Maple/Black	SB402M/B
Maple/Aluminum	SB402M/A
Walnut/Black	SB402W/B
Walnut/Aluminum	SB402W/A

23.25"w x 41"h x 19.75"d  
• 4 Adjustable Shelves



### Synergy Single 603

Black/Black	603B/B
Black/Aluminum	603B/A
Cherry/Black	603C/B
Cherry/Aluminum	603C/A
Maple/Black	603M/B
Maple/Aluminum	603M/A
Walnut/Black	603W/B
Walnut/Aluminum	603W/A

23.25"w x 60"h x 19.75"d  
• 6 Adjustable Shelves



### Synergy Single 703

Black/Black	703B/B
Black/Aluminum	703B/A
Cherry/Black	703C/B
Cherry/Aluminum	703C/A
Maple/Black	703M/B
Maple/Aluminum	703M/A
Walnut/Black	703W/B
Walnut/Aluminum	703W/A

23.25"w x 70"h x 19.75"d  
• 7 Adjustable Shelves



### Synergy Twin 221

Black/Black	SB221B/B
Black/Aluminum	SB221B/A
Cherry/Black	SB221C/B
Cherry/Aluminum	SB221C/A
Maple/Black	SB221M/B
Maple/Aluminum	SB221M/A
Walnut/Black	SB221W/B
Walnut/Aluminum	SB221W/A

44.5"w x 21"h x 19.75"d  
• 2 Adjustable Shelves



### Synergy Twin 229

Black/Black	SB229B/B
Black/Aluminum	SB229B/A
Cherry/Black	SB229C/B
Cherry/Aluminum	SB229C/A
Maple/Black	SB229M/B
Maple/Aluminum	SB229M/A
Walnut/Black	SB229W/B
Walnut/Aluminum	SB229W/A

44.5"w x 21"h x 19.75"d  
Center Opening 41"w x 18"d x 8.5"h



### Synergy Twin 323

Black/Black	SB323B/B
Black/Aluminum	SB323B/A
Cherry/Black	SB323C/B
Cherry/Aluminum	SB323C/A
Maple/Black	SB323M/B
Maple/Aluminum	SB323M/A
Walnut/Black	SB323W/B
Walnut/Aluminum	SB323W/A

44.5"w x 31"h x 19.75"d  
• 4 Adjustable Shelves



### Synergy Twin 329

Black/Black	SB329B/B
Black/Aluminum	SB329B/A
Cherry/Black	SB329C/B
Cherry/Aluminum	SB329C/A
Maple/Black	SB329M/B
Maple/Aluminum	SB329M/A
Walnut/Black	SB329W/B
Walnut/Aluminum	SB329W/A

44.5"w x 31"h x 19.75"d  
• 2 Adjustable Shelves



### Synergy Triple 132

Black/Black	SB132B/B
Black/Aluminum	SB132B/A
Cherry/Black	SB132C/B
Cherry/Aluminum	SB132C/A
Maple/Black	SB132M/B
Maple/Aluminum	SB132M/A
Walnut/Black	SB132W/B
Walnut/Aluminum	SB132W/A

65.75"w x 12"h x 19.75"d  
Center Opening 19.75"w x 18"d x 8.5" h



### Synergy Triple 133

Black/Black	SB133B/B
Black/Aluminum	SB133B/A
Cherry/Black	SB133C/B
Cherry/Aluminum	SB133C/A
Maple/Black	SB133M/B
Maple/Aluminum	SB133M/A
Walnut/Black	SB133W/B
Walnut/Aluminum	SB133W/A

65.75"w x 12"h x 19.75"d



### Synergy Triple 237

Black/Black	SB237B/B
Black/Aluminum	SB237B/A
Cherry/Black	SB237C/B
Cherry/Aluminum	SB237C/A
Maple/Black	SB237M/B
Maple/Aluminum	SB237M/A
Walnut/Black	SB237W/B
Walnut/Aluminum	SB237W/A

65.75"w x 21"h x 19.75"d  
• 3 Adjustable Shelves

W Wall Mountable,  
see kit on page 81.

Speaker Integration

