

SUBMERSIBLE DEWATERING PUMPS

COMPREHENSIVE PRODUCT PORTFOLIO
FOR DEMANDING APPLICATION ENVIRONMENTS

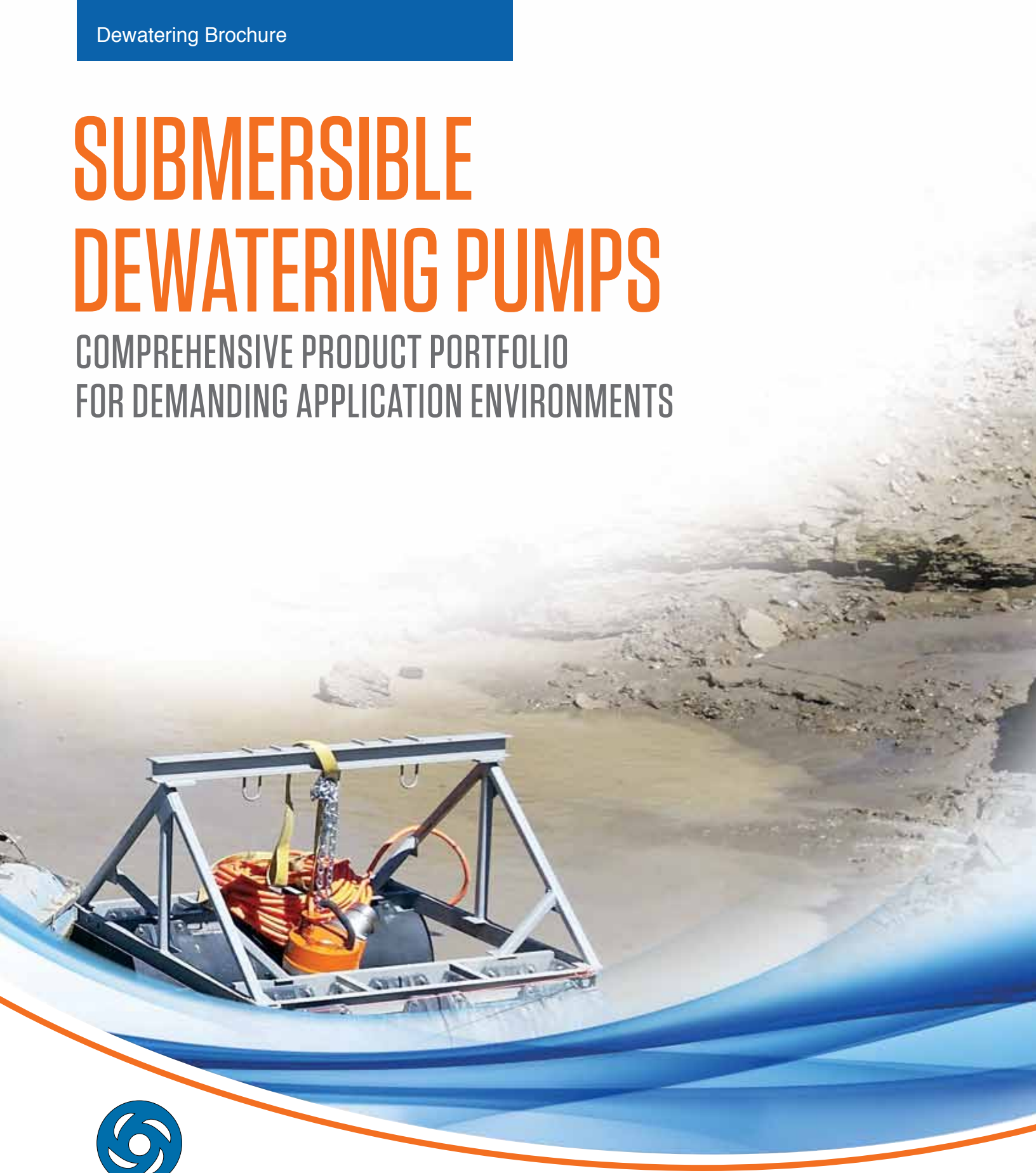

STANCOR™

Pump & Control Solutions

BUILDING TRADES | CONSTRUCTION | MINING | UTILITIES | WASTEWATER

STANCOR HISTORY

Stancor was founded in 1985, when Swedish manufacturer Alimak Corp's submersible pump business was purchased. The company was bought by its current owner, Knox Capital, in 2014.

More than 30 years of experience providing solutions with a complete line of pumps has built a strong reputation for performance in markets including: Construction, Industrial, Mining, Utilities and Wastewater. Stancor excels in the most demanding applications.

A commitment to focusing on our customers' profitability has created an unrelenting pursuit for industry leadership in quality and service. Hand-in-hand with that commitment is utilizing premium components and upgrading our product portfolio to meet application needs. This has led to a market leadership position in Coal Mining with a broad line of MSHA-approved, USA-made pumps.

Stancor focuses on solutions. Oil Minder, combined with our portfolio of pumps, creates a system that both manages both water and oil in confined spaces like elevator shafts and transformers. Patented technology is at the heart of Oil Minder's competitive advantage.



G&G Controls

was acquired in 2016 to provide another level of customization. The addition of 35+ years of experience, and certification for both UL 508A and UL 698A, provides full product and service support no matter the location or complexity.

Stancor is more than just products. The ability to combine pumps and controls, with the support of services that focus on exceeding expectations, has led to alignment around offering comprehensive solutions.



THE STANCOR DIFFERENCE

There are no shortage of pump manufacturers. While competitors sought cost reductions, Stancor strives to be different with an uncompromising commitment to quality—using robust components, thorough testing procedures and maintaining US manufacturing operations. That commitment to the customer continues to make Stancor a trusted partner.

Design decisions, backed by decades of proven performance, has allowed Stancor to build a strong reputation for performance in difficult operating environments. Inherent in that value proposition are several principles that continue to guide how Stancor operates:

PUTTING THE CUSTOMER FIRST

Stancor views itself as a partner much more than a supplier. Whether that requires design customization, short leadtimes and/or field trouble-shooting, we embrace the opportunity to work hand-in-hand with our customers to solve problems and create newfound efficiencies—and do so quickly.

RELIABLE PRODUCTS

Stancor products are designed to perform in demanding applications. Each pump and accompanying system is backed by a commitment to quality and a service promise to exceed expectations.

CUSTOMIZED SOLUTIONS

A full product portfolio, paired with a controls business, is guided by 35+ years of application knowledge to ensure customer expectations are exceeded. The right answer is defined by application performance. Stancor embraces customization as a means to exceed expectations.

DEDICATION TO REDUCE TOTAL COST OF OWNERSHIP

Ultimately, Stancor wants to be judged by the success and profitability of our customers. We drive that effort through reliable products that decrease maintenance costs and downtime through unmatched customer service.

INTERNATIONAL EXPERIENCE. LOCAL SUPPORT.

Stancor is large enough to apply a world of knowledge. But small enough to do so with personalized service and support that ensures satisfaction every time a Stancor product is designed, implemented and maintained.

You have many choices. Our goal is to be easy to do business with and rewarding to customers that are willing to put their reputations on the line to choose Stancor. Ultimately, our goal is create loyalty based on the customer experience and product performance.



PRODUCT FEATURES

1 Housing

Heavy duty cast aluminum 356 T6 for durability

2 NPT discharge connection

Made from stainless steel to increase life

3 Thermal protection

Thermal switches within the windings provide automatic reset of contactor

4 Cable

Heavy duty and jacketed with 50 feet of cable as the standard

5 Motor

Dry, shell type, squirrel-cage induction motor with sensors to prevent overheating is standard

6 Bearings

Sealed and lubricated for life to minimize maintenance

7 Mechanical seals

Tandem seal system for maximum leak protection

8 Impeller

Stainless steel is standard, upgrade option to high chrome

9 Rotor shaft

Made from 400 Series stainless steel

10 Wear plates

Easily adjustable, wear resistant nitrile rubber clad with many options available

11 Strainer

Stainless steel with slotted holes to prevent debris entrance

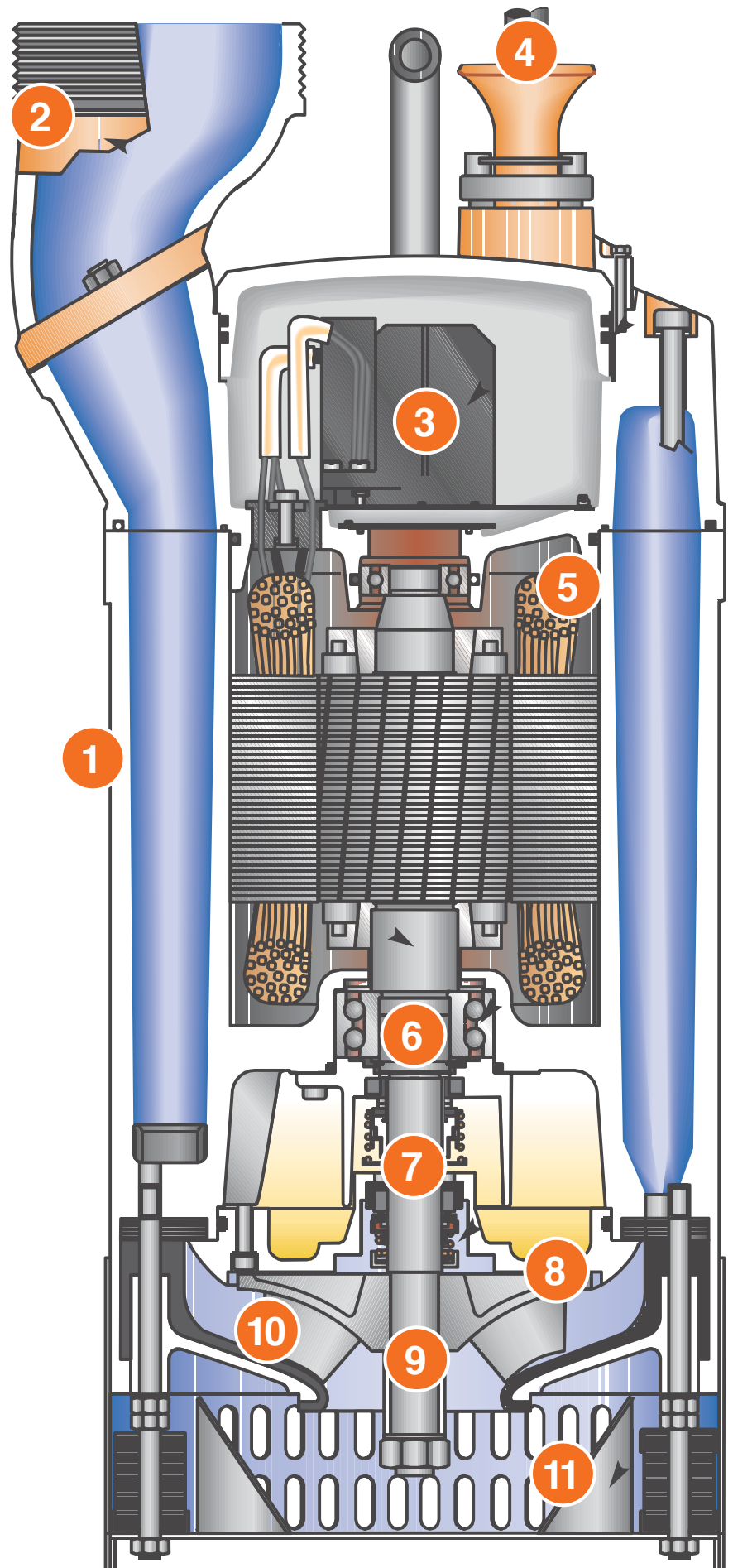

CERTIFICATIONS



Stancor is proud to manufacture dewatering pumps at its corporate headquarters in Monroe, CT. Our associates apply decades of experience to every pump that is produced—maximizing our confidence in creating a quality product intended to exceed customer expectations.



Mine Safety & Health Administration (MSHA) certification is a set of criteria intended to keep miners safe and healthy. Stancor is pleased to join other industry stakeholders in a collaboration to set safety standards, such protection from explosions. Products with MSHA approval are available upon request.



CSA International (Canadian Standards Association) is a provider of product testing and certification for electrical, mechanical, plumbing, gas and a variety of other products. Stancor products are available with CSA certification for use in Canada upon request.

STANDARD DEWATERING

S150 / P20CE (MSHA)



Phase	1*	3
Motor Rating	1.5 HP	1.5 HP
Voltage	115/230	230/460/575
Full Load Amps	13/4.8	4.8/2.24/2.2
Discharge	2" NPT male	
Dimensions	15.5" (H) / 8.5" (D)	
Weight	41 lbs	
Cable	50' 14/4 SO	
MSHA	50' 14/5 RC	

*Not available in CSA

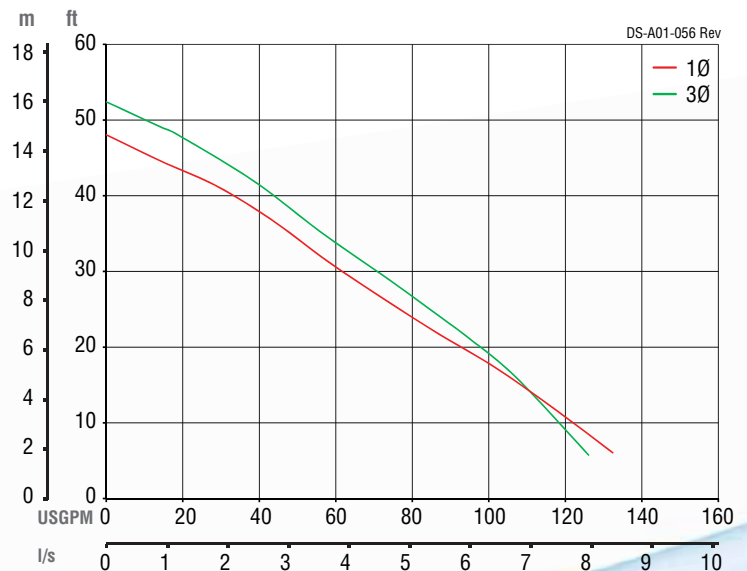

STANDARD DEWATERING

S500 / P30CE (MSHA)



Phase	1*	3
Motor Rating	4.6 HP	4.6 HP
Voltage	230	230/460/575
Full Load Amps	18	13/6.5/4.8
Discharge	3" NPT male	
Dimensions	23 1/4" (H) / 10" (D)	
Weight	77 lbs	
Cable	50' 12/4 SOOW	
MSHA	50' 12/5 RC	

*Not available in MSHA

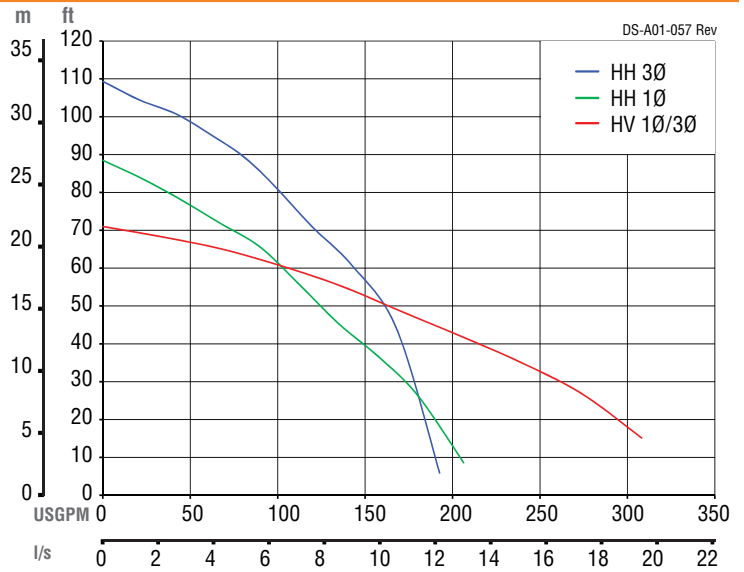

S750 / P40CE (MSHA)



Phase	1*	3
Motor Rating	6.4 HP	6.4 HP
Voltage	230	230/460/575
Full Load Amps	22	17.8/8.9/8.6
Discharge	3" (HH) or 4" (HV) NPT	
Dimensions	25.25" (H) / 9.625" (D)	
Weight	87 lbs	
Cable	50' 12/4 SO	
MSHA	50' 12/5 RC	

*Not available in MSHA

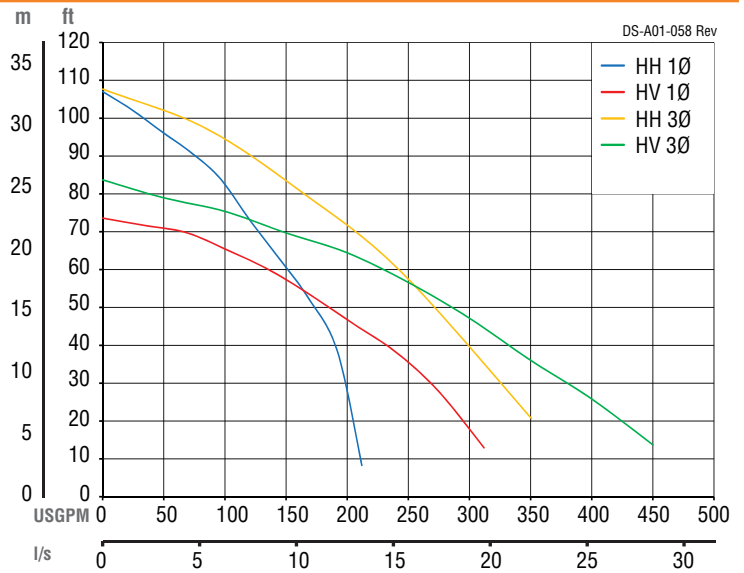

S1000 / SX1000 (MSHA)



Phase	3	
Motor Rating	10 HP	
Voltage	208/230/460/575	
Full Load Amps	39/35/17.5/14	
Discharge	3" (HH) or 4" (HV) NPT	
Dimensions	29.81" (H) / 11" (D)	
Weight	124 lbs	
Cable		
208/230V	50' 8/3 G-GC	
460/575V	50' 12/4 SOOW	
MSHA	50' 10/5 RC	

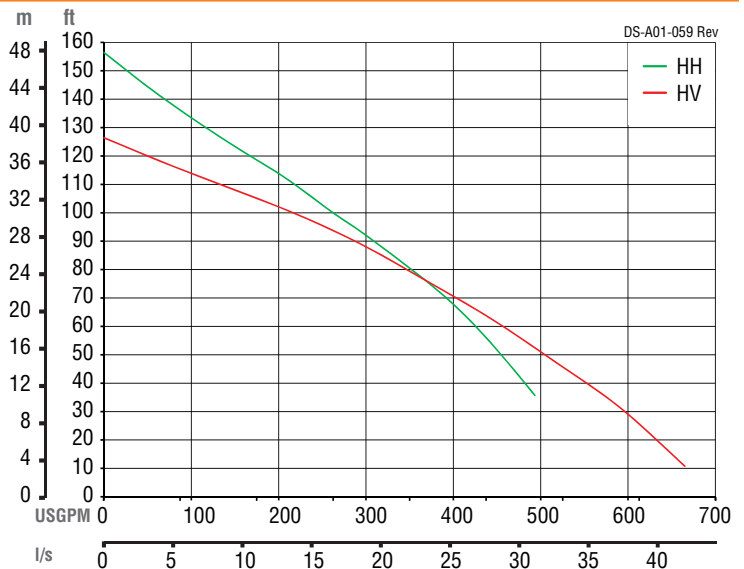

STANDARD DEWATERING

S1500 / P60CEM (MSHA)



Phase	3
Motor Rating	13 HP (MSHA)/15 HP
Voltage	230/460/575/950
Full Load Amps	40/20/14/12
Discharge	4" (HH) or 6" (HV/MR) NPT
Dimensions	33" (H) / 16.125" (D)
Weight	244 lbs
Cable	
230/460/575V	50' 6/3 G-GC
950V	50' 12/3 SHD-GC
MSHA (230/460/575V)	50' 6/3 GGC
MSHA (950V)	50' 6/3 SHD-GC

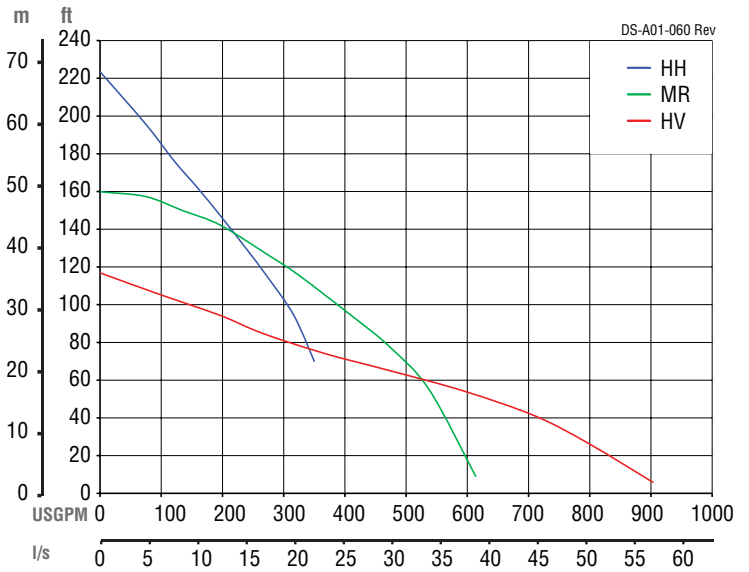

S2000 / SX2000 (MSHA)



Phase	3
Motor Rating	18 HP (MSHA)/20 HP
Voltage	230/460/575/950
Full Load Amps	49/24.5/17.25/13
Discharge	4" (HH) or 6" (HV/MR) NPT
Dimensions	35.125" (H) / 16.125" (D)
Weight	282 lbs
Cable	
230/460/575V	50' 6/3 G-GC
950V	50' 6/3 SHD-GC
MSHA (230/460/575V)	50' 6/3 G-GC
MSHA (950V)	50' 6/3 SHD-GC

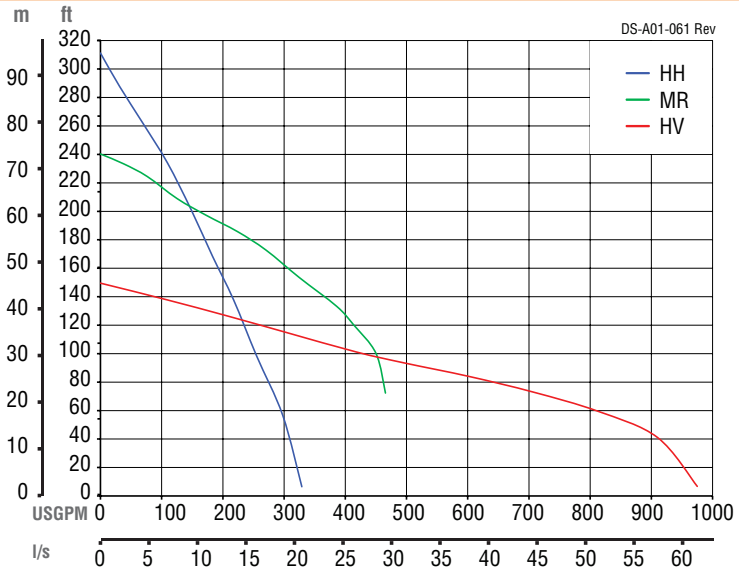

S3000 / P70CE (MSHA)



Phase	3
Motor Rating	28 HP (MSHA)/30 HP
Voltage	230/460/575/950
Full Load Amps	80/39/30/20
Discharge	4" (HH) or 6" (HV/MR) NPT
Dimensions	33.125" (H) / 16.125" (D)
Weight	326 lbs
Cable	
230V	50' 4/3 G-GC
460/575V	50' 6/3 G-GC
950V	50' 6/3 SHD-GC
MSHA (230/460/575V)	50' 6/3 G-GC
MSHA (950V)	50' 6/3 SHD-GC

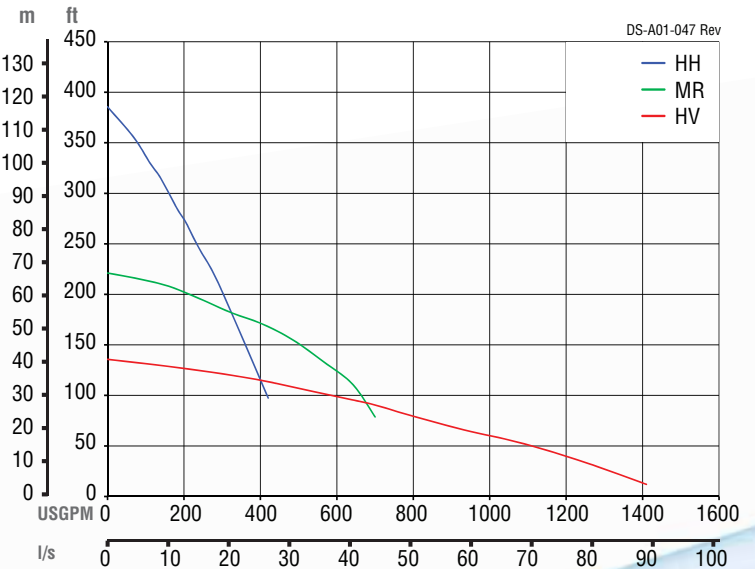

STANDARD DEWATERING

S4500 / SX4500 (MSHA)



Phase	3
Motor Rating	45 HP
Voltage	460/575/950
Full Load Amps	52/41/25
Discharge	4" (HH) or 6" (HV/MR) NPT
Dimensions	39" (H) / 16.125" (D)
Weight	345 lbs
Cable	
460/575V	50' 6/3 G-GC
950V	50' 6/3 SHD-GC
MSHA (460/575)	50' 6/3 G-GC
MSHA (950V)	50' 6/3 SHD-GC

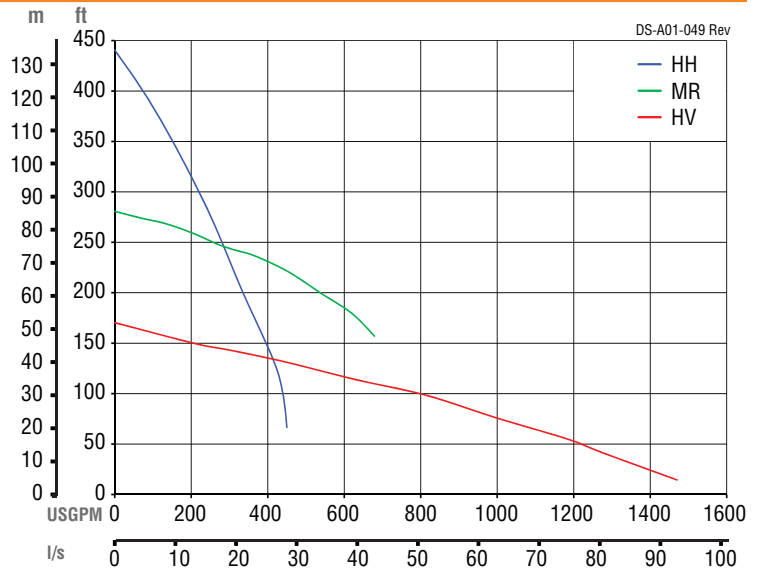

S6000 / SX6000 (MSHA)



Phase	3
Motor Rating	60 HP
Voltage	460/575/950
Full Load Amps	77/62/37
Discharge	4" (HH) / 6" (HV/MR) NPT, 10" optional
Dimensions	HH: 46" (H) / 36" (D) MR: 46" (H) / 37" (D) HV: 49" (H) / 37" (D)
Weight	1,140 (HH) / 1,200 (HV/MR) lbs
Cable	
460/575V	50' 4/3 G-GC
950V	50' 6/3 SHD-GC
MSHA (460/575V)	50' 4/3 G-GC
MSHA (950V)	50' 6/3 SHD-GC

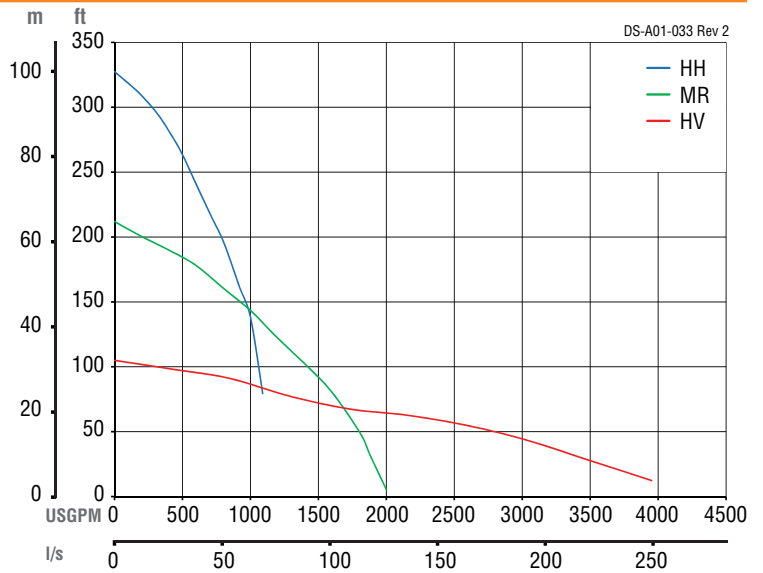

S7500 / SX7500 (MSHA)



Phase	3
Motor Rating	75 HP
Voltage	460/575/950
Full Load Amps	86/69/42
Discharge	6" NPT
Dimensions	44" (H) / 36" (D)
Weight	1,140 lbs
Cable	
460V	50' 4/3 G-GC
575V	50' 4/3 G-GC
950V	50' 6/3 SHD-GC
MSHA	same as standard

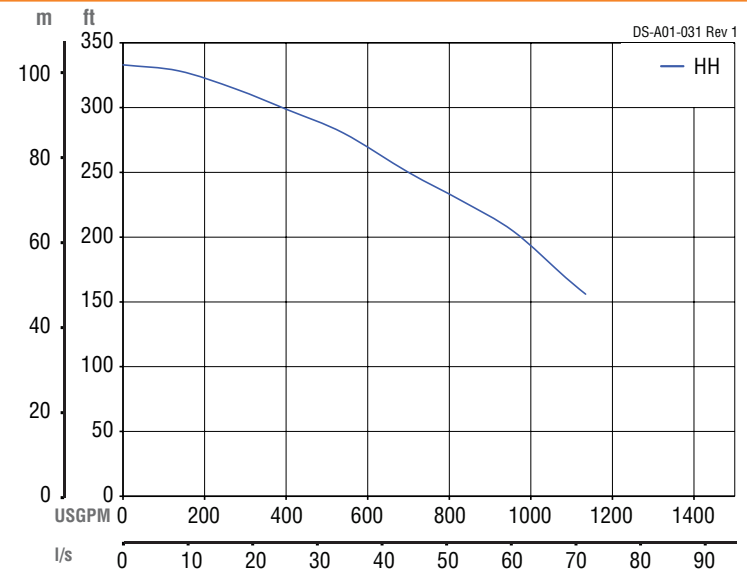

TRASH PUMPS

SL500-2 / P30CSE-2 (MSHA)



Phase	1*	3
Motor Rating	4.6 HP	4.6 HP
Voltage	230V	230/460/575V
Full Load Amps	18	12/6/4.8
Discharge	3" NPT male	
Dimensions	25.25" (H) / 16.5" (D)	
Weight	77 lbs	
Cable		
230V 1 phase	50' 12/4 SOOW	
230V 3 phase	50' 12/5 SOOW	
460/575V	50' 12/5 SOOW	
MSHA	50' 12/5 RC	

*Not available in MSHA

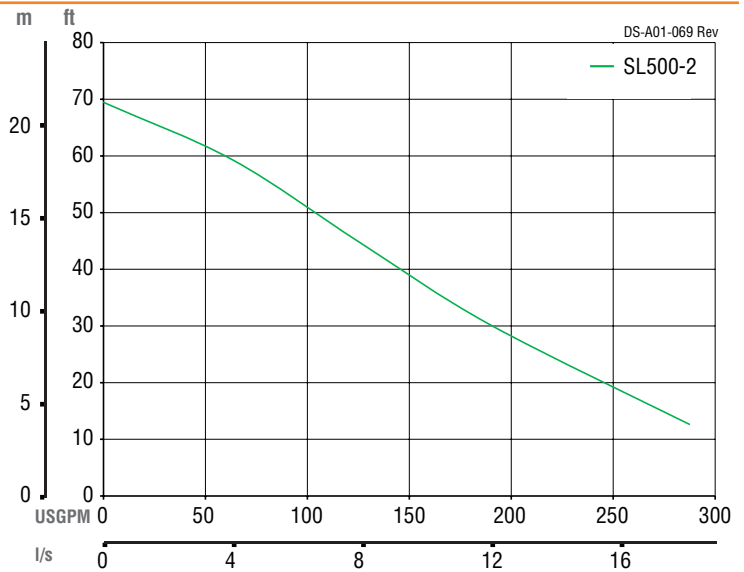

SL750-2 / P40CSE-2 (MSHA)



Phase	1	3
Motor Rating	6.4 HP	6.4 HP
Voltage	230V	230/460/575V
Full Load Amps	22	17.8/8.9/8.6
Discharge	3" or 4" NPT male	
Dimensions	27.25" (H) / 16.5" (D)	
Weight	127 lbs	
Cable		
230V 1 phase	50' 12/4 SOOW	
230V 3 phase	50' 12/4 SOOW	
460/575V	50' 12/5 SOOW	
MSHA	50' 12/5 RC	

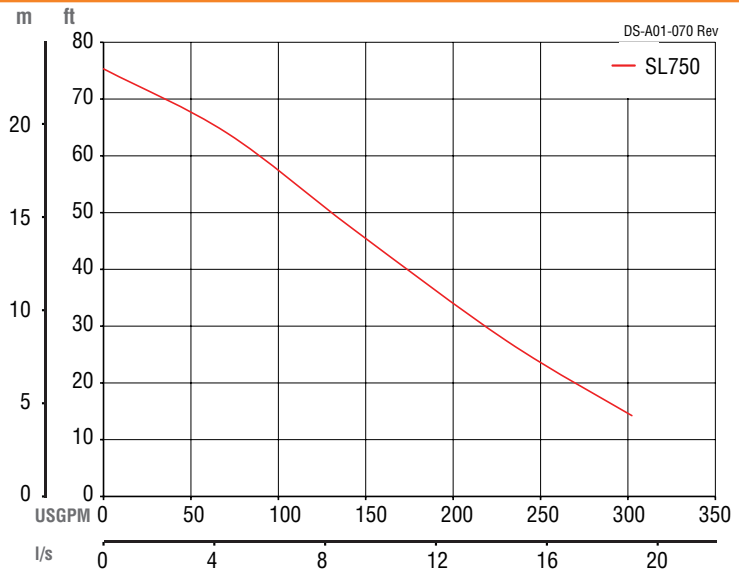

SL1000-2 / P50CSE-2 (MSHA)



Phase	3
Motor Rating	10 HP
Voltage	460/575V
Full Load Amps	14/11
Discharge	3" NPT male
Dimensions	28.5" (H) / 13" (D)
Weight	152 lbs
Cable	50' 10/5 SOOW
MSHA	50' 12/5 RC

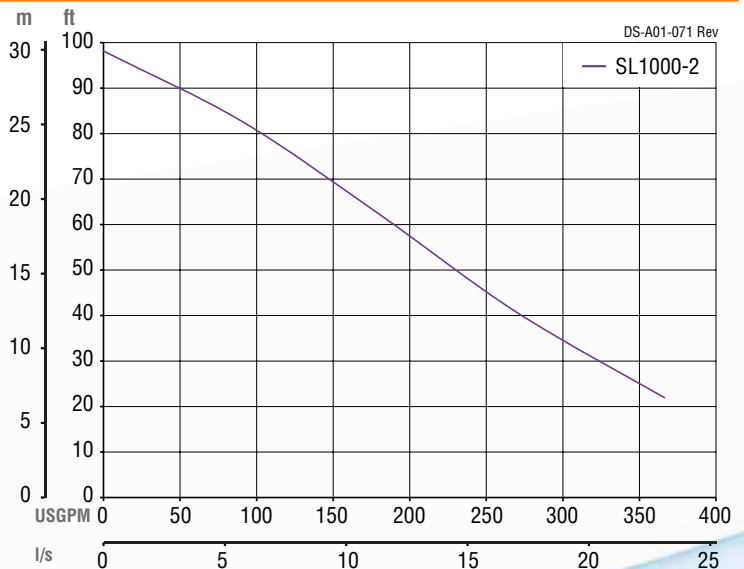

TRASH PUMPS (Stainless)

P50CSS/P50CSSSE-2 (MSHA)



Phase	3
Motor Rating	10 HP
Voltage	460/575V
Full Load Amps	14/11
Discharge	3" NPT male
Dimensions	28.5" (H) / 13" (D)
Weight	230 lbs
Cable	50' 10/5 SOOW
MSHA	50' 12/5 RC

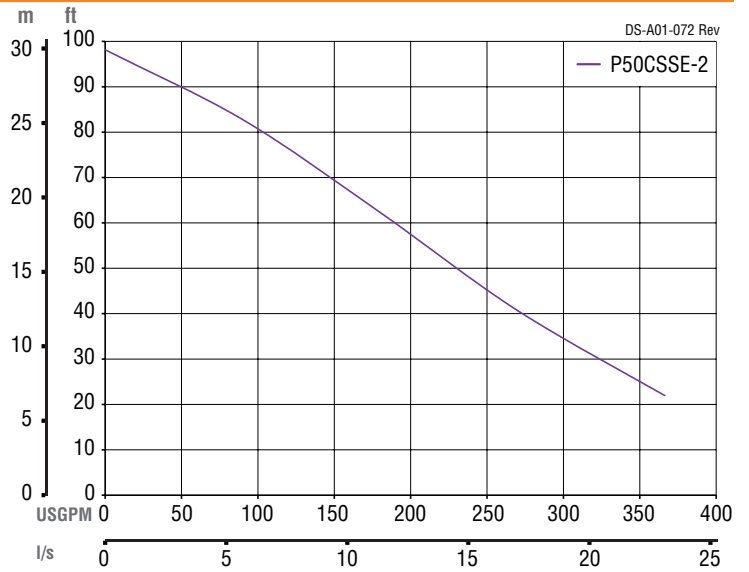

MARKET FOCUS

Stancor products have a strong reputation for performance in demanding applications. A loyal customer base can attest to our commitment to quality products supported by superior service.

While competitors have engineered cost out of their products, Stancor has doubled down on its uncompromising standards for component integrity. Products proudly made in the USA are designed and manufactured to exceed expectations in applications that can't afford downtime.

A requirement for robust products, engineered to withstand difficult environments, is an opportunity for Stancor to provide a solution. Aggregate, Construction and Mining present performance challenges that suit the inherent attributes of Stancor products and its accompanying dedication to create value for its customers.

AGGREGATE



CONSTRUCTION



MINING



SOLIDS HANDLING VORTEX PUMPS

S1500-TS4P / P60CEM-TS4P (MSHA)



Phase	3
Motor Rating	15 HP / 13 HP (MSHA)
Voltage	460/575/950
Full Load Amps	20/14/12
Discharge	4" ANSI flange
Dimensions	41.125" (H) / 30" (D)
Weight	543 lbs
Cable	
460/575V	50' SOOW 10/5 8/3, 6/3, 4/3 G-GC
950V	50' 6/3, 4/3 SHD-GC
MSHA	same as standard

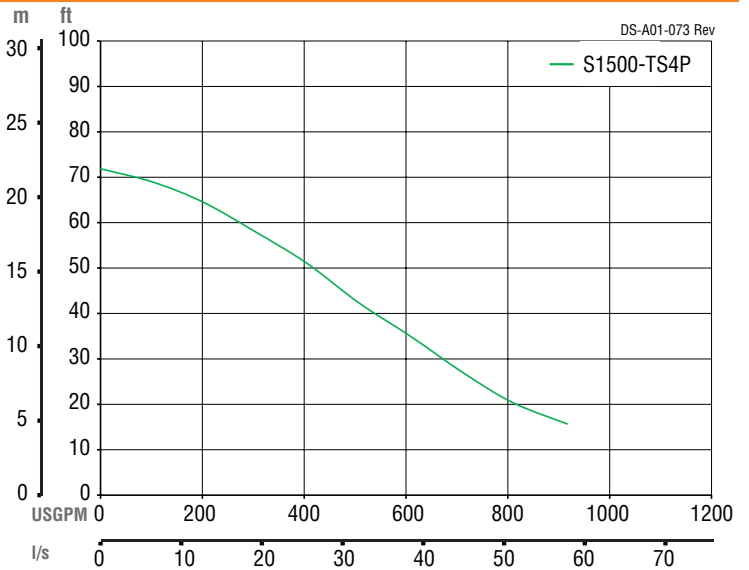

S2000-TS4P / SX2000-TS4P (MSHA)



Phase	3
Motor Rating	20 HP / 18 HP (MSHA)
Voltage	460/575/950
Full Load Amps	24.5/17.5/13
Discharge	4" ANSI flange
Dimensions	41.125" (H) / 30" (D)
Weight	563 lbs
Cable	
460/575V	50' SOOW 8/3, 6/3, 4/3 G-GC
950V	50' 6/3, 4/3 SHD-GC
MSHA	same as standard

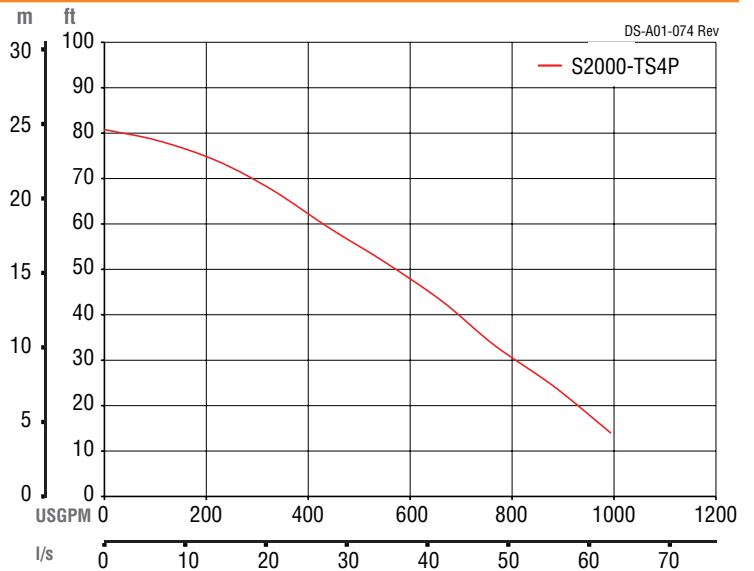

S3000-TS4P / P70-TS4P (MSHA)



Phase	3
Motor Rating	30 HP / 28 HP (MSHA)
Voltage	460/575/950
Full Load Amps	39/30/20
Discharge	4" ANSI flange
Dimensions	45.125" (H) / 30" (D)
Weight	582 lbs
Cable	
460/575V	50' SOOW 6/3, 4/3, 2/3 G-GC
950V	50' 6/3, 4/3, 2/3 SHD-GC
MSHA	same as standard

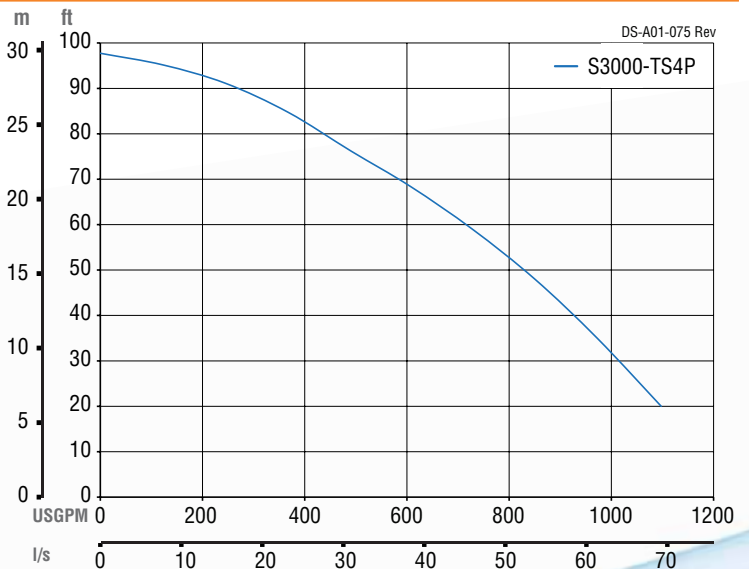

COMPREHENSIVE PUMP PORTFOLIO

FULL RANGE OF PRODUCTS TO ADDRESS A VARIETY OF APPLICATION NEEDS



AHS SERIES

Wastewater pump featuring an abrasion-resistant impeller, hardened steel agitator, die cast aluminum body and a high efficiency motor.



SB SERIES

Designed for storm water and effluent applications, capable of passing small solids.



LX SERIES

Heavy duty wastewater pump with non-clog impeller, double mechanical seals and a robust construction capable of passing 3" solids.



SC SERIES

Includes impeller with a tungsten cutter edge for solids in wastewater treatment and ground drainage applications.



SE/SV SERIES

Offers large impeller clearance to serve as a reliable, affordable pump for a variety of wastewater and stormwater removal.



SG SERIES

Grinder pump equipped with two circular, hardened cutter elements made of High Chrome alloy (HRC 58) for wastewater and sewage applications.



SEW SERIES

Features a recess vortex impeller made from cast iron to create a heavy-duty pump that can pass up to 3" solids.



SKR SERIES

Cast iron pump, featuring hardened alloy wet-end materials and High Chrome agitator, for slurry and dense fluids with specific gravities up to 1.25 SG.



SL SERIES

Created with stainless steel housing for applications featuring corrosive contaminants and small solids (<2mm). SL pumps have a low suction collar that enables a pump-down range of 1/8 of an inch from the bottom.



SSS/SSD SERIES

Designed with 304 stainless components and enhanced sealing for corrosive applications. Top discharge design allows dry run capability.

VALUE-ADDED OPTIONS

Stancor embraces customization. An unrelenting commitment to both products and service offers a personalized touch and creates more value than the competition. The ability to adopt a pump to your specific application needs has resulted from a wide range of products and technologies, developed over decades, that can be applied to improve performance.

Listed below are two options to improve operations and, as a result, your return on investment from Stancor products. Standard part numbers have been developed so these options are easy to order and apply to your specific needs. And new variations can be added to meet our commitment to exceed performance expectations time after time.

WELL CASING PUMPS

Stancor slim line, or Well Casing Pumps, fit in 8-inch or 12-inch casings and are used in narrow applications within Excavation, Construction and Mining applications. The pumps, which come standard with 100 feet of cable to extend down wells, can also feature High Chrome impellers for additional protection in abrasive environments. The product line features three models:

- 1. WCP-400 HH (4 HP)
2" discharge
Fits in 8" casing
- 2. WCP-400 HV (4HP)
3" discharge
Fits in 8" casing
- 3. WCP-1100 HH
3" discharge
Fits in 12" casing

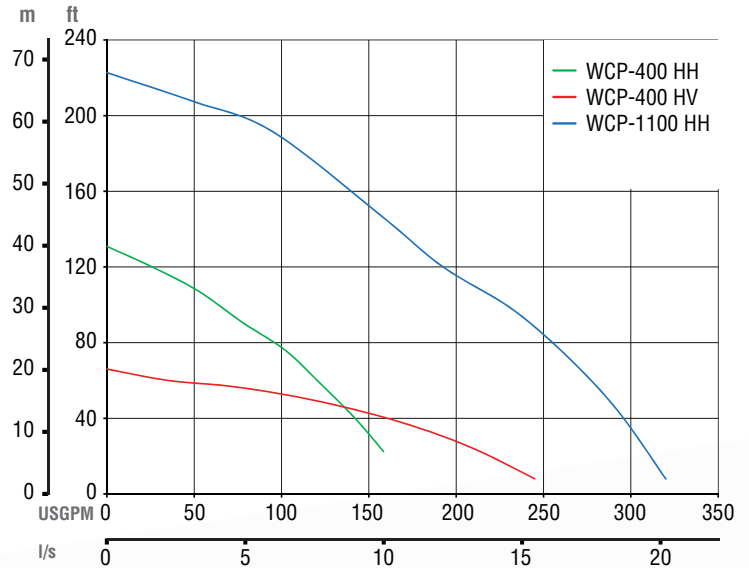

HIGH CHROME IMPELLER

Implementing High Chrome impellers in either Dewatering or Trash pumps offers additional protection in demanding environments—providing durability against abrasive materials and lengthening service life. With a Rockwell hardness of 62 HRC, and a Brinell hardness of 650+, pumps with High Chrome impellers are more wear resistant than duplex stainless steel in abrasive, non-corrosive applications. High Chrome impellers are ideally suited for Aggregate, Concrete and Mining.

SERVICE AND ACCESSORIES

Stancor takes pride in being a one-stop shop for pumping needs. The true measure of our performance is the return on investment customers receive from Stancor products, as measured by product life, serviceability, energy savings and liability protection. Maximizing the value from those measures depends on selecting the right product, maintaining it properly and placing it into a system that supports the application's needs.

Creating the right pump ecosystem is a Stancor advantage. The ability to specify a pump with the best features and then combine it with a control that guides and monitors performance has evolved Stancor from a supplier of products to a provider of solutions.

CONTROLS

Stancor offers a full range of control panels to address dewatering needs. The Model 821 family of products are fully-programmable, solid state liquid level controller and motor protection relay. This "float-less" control is MSHA approved. Additional features, using expertise from G&G Controls, can be added to the base model for increased functionality.



821 Controller

Ready-made systems consisting of complete panels create plug-and-play options.

ACCESSORIES

It is critical to performance that the end product is greater than the sum of its parts. However, specifying the right components, including cabling and floats, are vital to a comprehensive solution. Stancor offers a variety of options to ensure reliability is maintained throughout the system.



UL Components

Insisting on high quality components, including those used in pumps, is a hallmark of Stancor's commitment to quality.

SERVICE

Exceeding expectations requires both product performance and superior service from specification to installation. Being easy to do business with is something in which Stancor takes a tremendous amount of pride – encompassing availability for technical questions, leadtimes responsive to emergencies and a willingness to do whatever is necessary for customer satisfaction.



Field Support & Service

Stancor's reputation is as good as its products perform. Service is an important part of that equation.

CUSTOMIZED SOLUTIONS

A SUCCESSFUL COLLABORATION— TAPPAN ZEE BRIDGE



The New NY Bridge project—overseeing a \$3.98 billion budget to replace the 3.1-mile Tappan Zee Bridge across the Hudson River—couldn't afford to make mistakes when moving the water under the bridge.

Stancor P-70-HH Series pumps were relied upon to move Hudson River water so the concrete in the main span tower pylons cured properly. Wedge wire screens, designed with 5mm openings, were added to prevent fish, eggs and larvae from being drawn into the pump.

The value-added product simultaneously:

- 1) ran cooling water 150 feet into the air at a flow rate to maintain structural concrete integrity and
- 2) protected river life by ensuring the Hudson River water temperature never rose by more than 3 degrees.

MOBILE INTEGRATED PACKAGES

Stancor's system approach has combined the pump, control and accessories into a package that can be specified to meet individual needs and easily moved to address applications in multiple locations.

The core of the solution is the Stancor electrical submersible pump (ESP). The ability to surround that high performance pump with the necessary components for a comprehensive solution leads to a one-stop shop to meet individual application needs. Internal knowledge of both pumps and controls provides Stancor competitive advantage.

G&G Controls, a division of Stancor, L.P., has more than 35 years of experience designing and building energy-efficient controls that increase reliability. That expertise ensures a system approach to exceed expectations in every application. Customization is embraced—allowing Stancor to design and manufacture a solution that balances performance and flexibility.

Combining pump and control knowledge into an integrated package creates newfound operational efficiencies that increases customer satisfaction and asset utilization.



OUR MISSION:

Stancor, L.P. is a leading designer and manufacturer of Electrical Submersible Pumps (ESPs), Oil Minder® Systems and Controls. More than 30 years of servicing the rotating industry has qualified Stancor to offer both standard and customized systems for virtually any application. Our engineering and service teams will help you specify the right solution for your project—maximizing your investment by accounting for specific environmental demands. Stancor's broad range of pumps are available from ½ to 75 HP. Each pump, and accompanying control, is supported by a commitment to quality that strives to exceed your expectations time and time again.



STANCOR™

Pump & Control Solutions

WWW.STANCORPUMPS.COM | 203.268.7513

© copyright 2018 Stancor, L.P.