

Motor-driven and process metering pumps
for all capacity ranges



ProMinent[®]

2018



Issued by:

ProMinent GmbH
Im Schuhmachergewann 5-11
69123 Heidelberg
Germany
Phone +49 6221 842-0
info@prominent.com
www.prominent.com



Technical changes reserved.

All previous catalogues and price lists are superseded with the release of this product catalogue.
You can view our general terms and conditions on our homepage.

Heidelberg, January 2018

Motor Driven and Process Metering Pumps



Performance by design

Industrial applications using fluid metering technology are many and varied. They are often critical and each industry has its own specific requirements. You will find the right product here, regardless of whether you require a reliable metering pump for a routine or more complex application.

Chapter 1 offers virtually all-purpose motor-driven diaphragm metering pumps for use in the low-pressure range up to a capacity of 1,000 l/h, to ensure that your processes operate safely to meet maximum requirements. Advanced technology for demanding applications.

Chapter 2 focuses on heavy-duty pumps for extreme applications. Process metering pumps for hazardous production processes in the petrochemical industry or in the oil and gas industry, tailored specifically for high-end applications. They have proved themselves able to meter, even under very high pressure and at extreme temperatures - even toxic, corrosive and flammable liquids.

Ready for you. Anytime, anywhere.

ProMinent is close to hand no matter where you are: 55 dedicated sales, production and service companies guarantee service and availability in close proximity to our customers. For many years this has meant a local presence for our customers in over 100 countries.

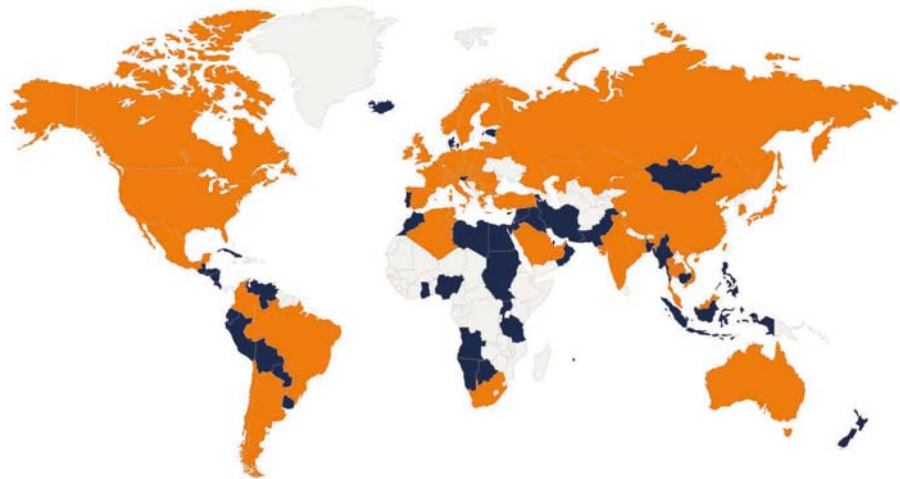

Our sales team will be happy to be of assistance should you have any questions about metering technology or water treatment. You will find the contact details of your local contact at www.prominent.com/en/locations.

Pump Guide

You can also find information online. The ProMinent pump selection guide is available on our website. Just enter the required pump capacity and back pressure, and the Pump Guide will show you a list of suitable metering pumps. This is the quick and easy way to track down precisely the right pump for your needs.

www.pump-guide.com



Upgrading of Orlita® Evolution product range using PVC and PVDF materials

Capacity range: 3 – 7,352 l/h at 21 – 10 bar

As highly robust hydraulic diaphragm metering pumps, the Orlita® Evolution with PVDF and PVC dosing heads meet the most stringent safety requirements for the capacity range 3 – 7,352 l/h at pressures up to 21 bar.

They stand out, among other things, thanks to their PTFE multi-layer diaphragm with integral diaphragm rupture warning system and diaphragm position control.

Their modular construction offers excellent flexibility as regards field of application. Following upgrading of the wetted materials using PVC and PVDF plastic, the pumps can now be used for an even wider range of applications.

For more information see page → 2-40



Plunger Metering Pump Orlita® Evolution

Capacity range of single pump: 5 – 511 l/h; 293 – 8 bar

The high-performance plunger metering pump ORLITA® Evolution enables precise pump capacities even at maximum pressure and temperatures of up to + 200 °C. The ORLITA® Evolution pump has a modular construction and thus versatile uses.

Flexible adaptation to the process:

- Precise capacity even at maximum pressure
- Metering reproducibility is better than $\pm 0.5\%$ within the 10 - 100 % stroke length range under defined conditions and with correct installation.
- Excellent hydraulic efficiency

Excellent flexibility:

- The modular and compact construction with single and multiple pump versions permits a wide range of applications. In multiple pump systems up to 5 metering units can be combined, including units with different pump capacities
- 7 gear ratios are available
- Power end configuration ideal for installation in any position (vertical or horizontal)
- Customised designs are available on request

For more information see page → 2-94



Motor-Driven and Process Pumps for all Capacity Ranges page

1	Motor-Driven Metering Pumps	1-1
1.0	Overview of Motor-Driven Metering Pumps	1-1
1.0.1	Selection Guide	1-1
1.0.2	Installation Options	1-2
1.1	Motor-Driven metering pump Vario C	1-3
1.1.1	Motor-Driven metering pump Vario C	1-3
1.1.2	Identity Code Ordering System for VAMc	1-5
1.1.3	Spare Parts	1-6
1.2	Motor-Driven Metering Pump Sigma/ 1 (Basic Type)	1-7
1.2.1	Motor-Driven Metering Pump Sigma/ 1 (Basic Type)	1-8
1.2.2	Spare Parts	1-12
1.3	Motor-Driven Metering Pump Sigma/ 1 (Control Type)	1-15
1.3.1	Motor-Driven Metering Pump Sigma/ 1 (Control Type)	1-15
1.3.2	Spare Parts	1-21
1.4	Motor-Driven Metering Pump Sigma/ 2 (Basic Type)	1-25
1.4.1	Motor-Driven Metering Pump Sigma/ 2 (Basic Type)	1-25
1.4.2	Spare Parts	1-29
1.5	Motor-Driven Metering Pump Sigma/ 2 (Control Type)	1-31
1.5.1	Motor-Driven Metering Pump Sigma/ 2 (Control Type)	1-31
1.5.2	Spare Parts	1-36
1.6	Motor-Driven Metering Pump Sigma/ 3 (Basic Type)	1-39
1.6.1	Motor-Driven Metering Pump Sigma/ 3 (Basic Type)	1-39
1.6.2	Spare Parts	1-43
1.7	Motor-Driven Metering Pump Sigma/ 3 (Control Type)	1-45
1.7.1	Motor-Driven Metering Pump Sigma/ 3 (Control Type)	1-45
1.7.2	Spare Parts	1-50
1.8	Hydraulic/Mechanical Accessories	1-53
1.8.1	Foot Valves for Motor-Driven Metering Pumps	1-53
1.8.2	Injection Valves for Motor-Driven Metering Pumps	1-56
1.8.3	Back Pressure Valves / Relief Valves for Motor-Driven Metering Pumps	1-61
1.8.4	Suction Lances, Suction Assemblies and Level Switches for Motor-Driven Metering Pumps	1-72
1.8.5	Fittings	1-76
1.8.6	Pulsation Damper	1-77
1.8.7	Accumulators	1-80
1.8.8	Accumulators Without Diaphragm	1-81
1.8.9	Connectors and Seals for Motor-Driven Metering Pumps	1-84
1.8.10	Metering Pump Wall Mounting Bracket	1-90
1.9	Electrical Accessories	1-91
1.9.1	Speed Controllers	1-91
1.9.2	General Electrical Accessories	1-93
1.10	Special Accessories	1-98
1.10.1	Custom Accessories	1-98
1.11	Application Examples	1-101
1.11.1	Metering of Highly Viscous Substances	1-101
1.11.2	Mixing Two Reagents	1-102
1.11.3	Safe and Reliable Chemical Metering with Reduced Pulsation	1-104
2	Process Metering Pumps	2-1
2.0	Overview of Process Metering Pumps	2-1
2.0.1	Selection Guide	2-1
2.0.2	Installation Applications	2-2
2.1	Diaphragm Metering Pump ProMinent EXtronic®	2-3
2.1.1	Diaphragm Metering Pump ProMinent EXtronic®	2-3
2.1.2	Identity Code Ordering System for EXBb	2-5
2.1.3	Spare Parts	2-6
2.1.4	Ex-Proof Ancillary Equipment	2-8



Motor-Driven and Process Pumps for all Capacity Ranges Seite

2.2	Diaphragm Metering Pump Makro TZ	2-10
2.2.1	Diaphragm Metering Pump Makro TZ	2-10
2.2.2	Identity Code Ordering System for TZMb	2-12
2.2.3	Spare Parts	2-13
2.3	Diaphragm Metering Pump Makro/ 5	2-16
2.3.1	Diaphragm Metering Pump Makro/ 5	2-16
2.3.2	Identity Code Ordering System M5Ma	2-18
2.3.3	Spare Parts	2-19
2.4	Hydraulic Diaphragm Metering Pump Hydro/ 2	2-21
2.4.1	Hydraulic Diaphragm Metering Pump Hydro/ 2	2-21
2.4.2	Identity Code Ordering System HP2a	2-24
2.4.3	Spare Parts	2-26
2.5	Hydraulic Diaphragm Metering Pump Hydro/ 3	2-29
2.5.1	Hydraulic Diaphragm Metering Pump Hydro/ 3	2-29
2.5.2	Identity Code Ordering System HP3a	2-32
2.5.3	Spare Parts	2-33
2.6	Hydraulic Diaphragm Metering Pump Hydro/ 4	2-35
2.6.1	Hydraulic Diaphragm Metering Pump Hydro/ 4	2-35
2.6.2	Identity Code Ordering System HP4a	2-38
2.6.3	Spare Parts	2-39
2.7	Hydraulic Diaphragm Metering Pump Makro/ 5	2-41
2.7.1	Hydraulic Diaphragm Metering Pump Makro/ 5	2-41
2.7.2	Identity Code Ordering System for M5Ha	2-44
2.7.3	Spare Parts	2-46
2.8	Hydraulic Diaphragm Metering Pump Orlita® Evolution 1	2-47
2.8.1	Hydraulic Diaphragm Metering Pump Orlita® Evolution 1	2-47
2.9	Hydraulic Diaphragm Metering Pump Orlita® Evolution 2	2-51
2.9.1	Hydraulic Diaphragm Metering Pump Orlita® Evolution 2	2-51
2.10	Hydraulic Diaphragm Metering Pump Orlita® Evolution 3	2-55
2.10.1	Hydraulic Diaphragm Metering Pump Orlita® Evolution 3	2-55
2.11	Hydraulic Diaphragm Metering Pump Orlita® Evolution 4	2-58
2.11.1	Hydraulic Diaphragm Metering Pump Orlita® Evolution 4	2-58
2.12	Hydraulic Diaphragm Metering Pumps Orlita® MF	2-61
2.12.1	Hydraulic Diaphragm Metering Pump Orlita® MF	2-61
2.12.2	Orlita® MFS 18 (MF1a) Hydraulic Diaphragm Metering Pumps	2-65
2.12.3	Orlita® MFS 35 (MF2a) Hydraulic Diaphragm Metering Pumps	2-68
2.12.4	Orlita® MFS 80 (MF3a) Hydraulic Diaphragm Metering Pumps	2-72
2.12.5	Orlita® MFS 180 (MF4a) Hydraulic Diaphragm Metering Pumps	2-75
2.12.6	Orlita® MFS 600 (MF5b) Hydraulic Diaphragm Metering Pumps	2-79
2.12.7	Orlita® MFS 1400 (MF6a) Hydraulic Diaphragm Metering Pumps	2-83
2.13	Hydraulic Diaphragm Metering Pump Orlita® MH	2-87
2.13.1	Hydraulic Diaphragm Metering Pumps Orlita® MH with Metal Diaphragm	2-87
2.14	Hydraulic Metal Diaphragm Metering Pump High-pressure Orlita® MHHP	2-89
2.14.1	Hydraulic Metal Diaphragm Metering Pump High-pressure Orlita® MHHP	2-89
2.15	Plunger Metering Pump Sigma/ 2 (Basic Type)	2-90
2.15.1	Plunger Metering Pump Sigma/ 2 (Basic Type)	2-90
2.15.2	Identity Code Ordering System for SBKa	2-93
2.15.3	Spare Parts Kits	2-94
2.16	Plunger Metering Pump Sigma/ 2 (Control Type)	2-95
2.16.1	Plunger Metering Pump Sigma/ 2 (Control Type)	2-95
2.16.2	Identity Code Ordering System for SCKa	2-97
2.16.3	Spare Parts Kits	2-98



Contents

Motor-Driven and Process Pumps for all Capacity Ranges page

2.17	Plunger Metering Pump Meta	2-99
2.17.1	Plunger Metering Pump Meta	2-99
2.17.2	Identity Code Ordering System for MTKa	2-102
2.17.3	Spare Parts	2-103
2.18	Plunger Metering Pump Makro TZ	2-104
2.18.1	Plunger Metering Pump Makro TZ	2-104
2.18.2	Identity Code Ordering System TZKa	2-107
2.18.3	Spare Parts Kits	2-108
2.19	Plunger Metering Pump Makro/ 5	2-109
2.19.1	Plunger Metering Pump Makro/ 5	2-109
2.19.2	Identity Code Ordering System for M5Ka	2-112
2.19.3	Spare Parts Kits	2-114
2.20	Plunger Metering Pump Orlita® Evolution 1	2-115
2.20.1	Plunger Metering Pump Orlita® Evolution 1	2-115
2.21	Plunger Metering Pump Orlita® Evolution 2	2-117
2.21.1	Plunger Metering Pump Orlita® Evolution 2	2-117
2.22	Plunger Metering Pump Orlita® PS	2-119
2.22.1	Plunger Metering Pump Orlita® PS	2-119
2.23	Plunger Metering Pump Orlita® DR	2-122
2.23.1	Plunger Metering Pump Orlita® DR	2-122
2.24	Diaphragm Process Pump Zentriplex	2-124
2.24.1	Diaphragm Process Pump Zentriplex	2-124
2.25	Hydraulic/Mechanical Accessories	2-126
2.25.1	Return/Pressure Relief Valve, Spring-loaded	2-126
2.25.2	Safety Valve	2-127
2.25.3	Pulsation Damper	2-128
3	Data Required for Specification of Metering Pump and Accessories	
4	ProMinent® Chemical Resistance List	



1.0 Overview of Motor-Driven Metering Pumps

1.0.1 Selection Guide

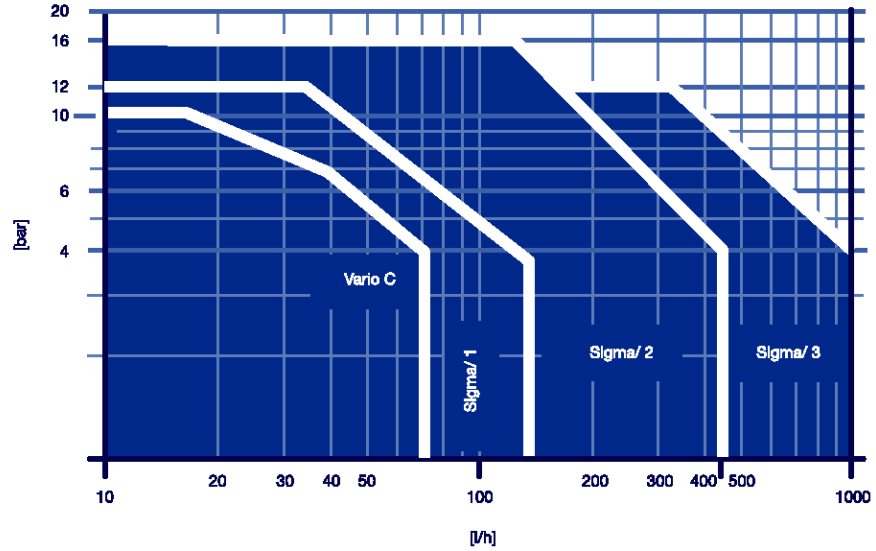

pk_2_diagramm

ProMinent offers an extensive range of metering pumps with a capacity rating of up to 1,000 l/h. All oscillating positive-displacement pumps feature a leak-free, hermetically sealed metering chamber and an identical operating structure.

Applications

- General: Chemical metering up to 1,000 l/h
- Potable water treatment: Metering of disinfectants
- Cooling circuits: Metering of disinfectants
- Waste water treatment: Metering of flocculants
- Paper industry: Metering of additives
- Plastics production: Metering of additives
- Textile industry: Metering of dyeing additives
- Electroplating: Metering of acids/lyes
- Automotive industry: Metering of cleaning agents
- Food industry: Metering of solids, concentrates, CIP cleaning agents
- Pool & Wellness: Metering of disinfectants

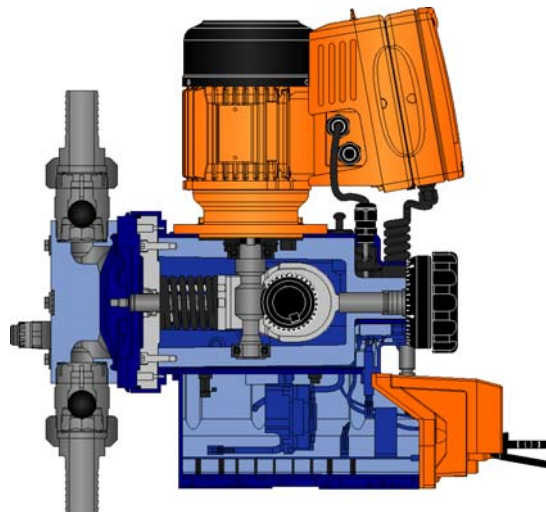

Sigma-bCGHR



1.0 Overview of Motor-Driven Metering Pumps

1.0.2 Installation Options

The smooth operation of metering systems depends not only on choosing the correct model for your application, but also on the correct installation of application-specific accessories. The drawing below illustrates a variety of accessory components, not all of which will be required for every plant, but which give an overview of what can be achieved in practical terms.

We are always at your service, to help you choose the right accessories for your processing application, and to provide any additional technical advice (e.g. calculating pipework requirements).

- 1 Metering pump
- 2 Activation and control option
- 3 Injection valve
- 4 Shut-off valve
- 5 Flow meter/monitor
- 6 Pulsation damper
- 7 Back pressure valve
- 8 Relief valve in the bypass line
- 9 Level switch
- 10 Foot valve
- 11 Manometer
- 12 System
- 13 Filling
- 14 Bleed valve
- 15 Suction line
- 16 Bypass

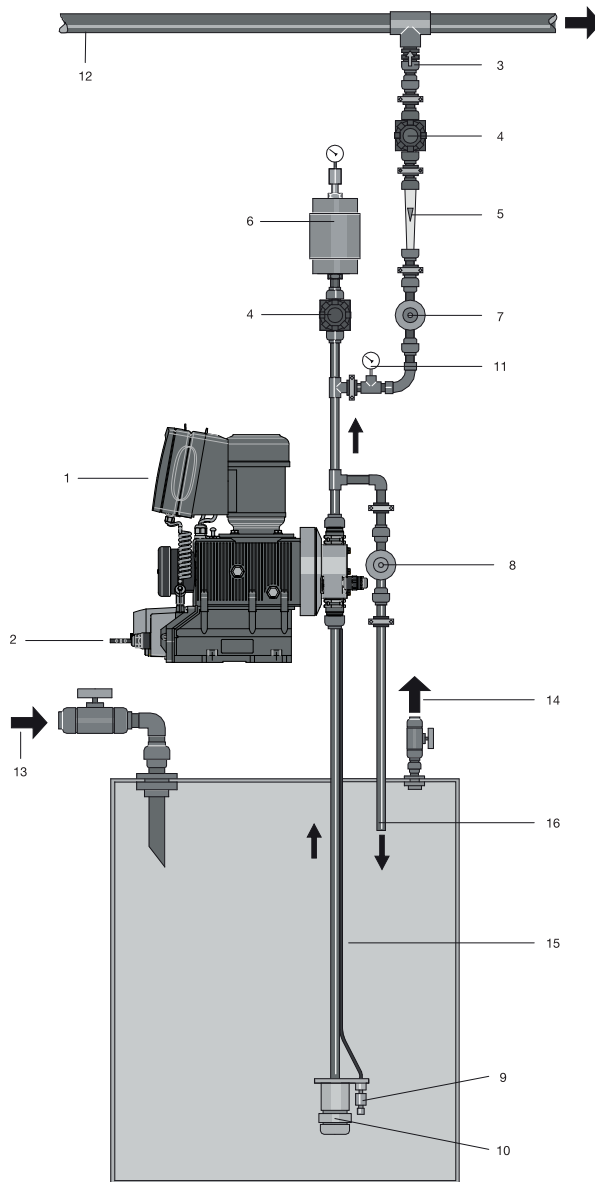

pk_2_000_1_1AK



1.1 Motor-Driven Metering Pump Vario C

1.1.1 Motor-Driven Metering Pump Vario C

The basic pump for simple applications

Capacity range 8 – 76 l/h, 10 – 4 bar



The motor-driven metering pump Vario C delivers a high level of process quality for continuous metering within simple metering tasks. It can be used, for example, in the metering of additives or flocculants in chemical metering.

With 4 gear reduction ratios, 2 dosing head sizes and 2 dosing head materials, the Vario C motor-driven metering pump is well adapted to basic metering tasks. It is available with a three-phase or single-phase AC motor. Its pump capacity is adjusted via the stroke length, in 1% increments, with a self-locking rotary dial.

Your benefits

- Excellent suction capacity, gentle metering stroke and consistently precise metering
- Excellent process quality: Metering reproducibility is better than $\pm 2\%$ within the stroke length adjustment range of 30 to 100%
- Flexible adjustment of the pump capacity by means of the stroke length in 1% increments
- Fibreglass-reinforced plastic housing
- Good adaptation to the specific application, thanks to 4 different gear reduction ratios and 2 sizes of liquid ends in 2 material versions
- Power end optionally available with three-phase or single-phase AC motor
- Customised designs are available on request

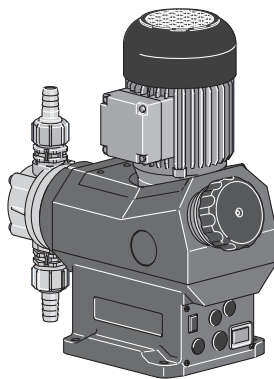

pk_2_126
Vario C

Technical Details

- Stroke length: 3 mm
- Stroke length adjustment range: 0 – 100 %
- Stroke length adjustment: manually by means of self-locking rotary dial
- Metering reproducibility is better than $\pm 2\%$ in the 30 – 100% stroke length adjustment range under defined conditions and with correct installation
- Wetted materials: PVDF, stainless steel 1.4571/1.4404
- DEVELOPAN® diaphragm (single diaphragm with PTFE)
- Motor: Three-phase AC motor (0.07 KW, 230/400 V, 50/60 Hz) or single-phase AC motor (0.06 kW, 230 V 50 Hz or 115 V 60 Hz)
- Degree of protection: IP 55
- Fibreglass-reinforced plastic housing
- Provide suitable overload protection in all motor-driven metering pumps during installation for safety reasons.

Field of application

- Chemical metering in potable water, cooling and waste water circuits
- Metering of additives, flocculants etc.

Technical Data

Type VAMc	With 1500 rpm motor at 50 Hz				With 1800 rpm motor at 60 Hz				Suction lift m WC	Perm. pre-pressure suction side bar	Connection, suction/ discharge side G-DN
	Delivery rate at max. back pressure		Max. stroke rate Strokes/min	Delivery rate at max. back pressure		Max. stroke rate Strokes/min					
	bar	l/h ml/stroke		psi	l/h/gph (US)						
10008	10	8	4	38	145	9.6/2.5	45	7	2.8	3/4-10	
10016	10	16	4	77	145	19.2/5.0	92	7	2.8	3/4-10	
07026	7	26	4	120	100	31.2/8.2	144	7	2.8	3/4-10	
07042	7	42	4	192	100	50.4/13.3	230	7	2.8	3/4-10	
07012	7	12	5	38	100	14.4/3.8	45	6	1.7	3/4-10	
07024	7	24	5	77	100	28.8/7.6	92	6	1.7	3/4-10	
04039	4	40	5	120	58	48.0/12.6	144	6	1.7	3/4-10	
04063	4	64	5	192	58	76.8/20.2	230	6	1.7	3/4-10	

The shipping weight of all pump types is 6/7.2 kg (PVDF/SS)



1.1 Motor-Driven Metering Pump Vario C

Materials in Contact With the Medium

Material	Dosing head	Suction/pressure connector	Seals	Valve balls	Valve seat
PVT	PVDF	PVDF	PTFE	Ceramic	PTFE
SST	Stainless steel material no. 1.4404	Stainless steel material no. 1.4581	PTFE	Stainless steel material no. 1.4404	PTFE

Motor Data

Identity code	Characteristic	Voltage supply			Remarks
S	3 ph, IP 55	220-240 V/380-420 V	50 Hz	0.07 kW	
		250-280 V/440-480 V	60 Hz	0.07 kW	
M	1 ph AC, IP 55	230 V ±5%	50/60 Hz	0.06 kW	
N	1 ph AC, IP 55	115 V ±5%	60 Hz	0.06 kW	

Motor data sheets can be requested for more information. Motors for Sigma basic pumps, special motors or special motor flanges are available on request.

Motors less than 0.75 kW and motors designed for speed-controllable operation are not subject to the IE3 standard in compliance with the Ecodesign Directive 2009/125/EC.



1.1 Motor-Driven Metering Pump Vario C

1.1.2 Identity Code Ordering System for VAMc

Vario Diaphragm Metering Pump

VAMc	Type*	bar	l/h
		10	8
		10	16
		7	26
		7	42
		7	12
		7	24
		4	40
		4	64
Material Liquid end			
	PVT	PVDF, PTFE seal	
	SST	stainless steel, PTFE seal	
Liquid end version			
	0	no valve spring (standard) PVC	
	1	with 2 valve springs. Hastelloy C4	
Hydraulic connection			
	0	standard connection	
	1	PVC union nut and insert	
	2	PP union nut and insert	
	3	PVDF union nut and insert	
	4	Stainless steel union nut and insert	
	5	PP union nut and hose nozzle	
	6	PVC union nut and hose nozzle	
	7	PVDF union nut and hose nozzle	
	8	Stainless steel union nut and hose nozzle	
Version			
	0	with ProMinent® logo (standard)	
	1	without ProMinent® logo	
	M	modified	
Electrical power supply			
	S	3 ph, 230 V / 400 V; 50/60 Hz	
	M	1 ph AC 230 V; AC 50/60 Hz	
	N	1 ph AC 115 V; AC 60 Hz	
Stroke sensor			
	0	no stroke sensor	
	3	with stroke sensor (Namur)	
Stroke length adjustment			
	0	manual (standard)	

* Digits 1 and 2=back pressure [bar]; digits 3, 4, 5=flow rate [l/h]



1.1 Motor-Driven Metering Pump Vario C

1.1.3 Spare Parts

The spare parts kit generally includes the wear parts for the liquid ends.

Scope of delivery with PPE, PCB, PVT material versions:

- 1 diaphragm
- 1 suction valve assembly
- 1 discharge valve assembly
- 2 valve balls
- 1 complete sealing set (O-rings or cover rings with PVT design)

Scope of delivery with SST material version:

- 1 diaphragm
- 2 valve balls
- 1 complete sealing set (cover rings, flat seals, ball seat)

Spare Parts Kit for Motor-Driven Metering Pump Vario c

Applicable to Identity code: Type VAMc 10008, 10016, 07026, 07042

Liquid end	Materials in contact with the medium	Order no.
FM 042 - DN 10	PPE	910753
FM 042 - DN 10	PCB	910754
FM 042 - DN 10	PVT	1003641
FM 042 - DN 10	SST	910751

Applicable to Identity code: Type VAMc 07012, 07024, 04039, 04063

Liquid end	Materials in contact with the medium	Order no.
FM 063 - DN 10	PPE	910758
FM 063 - DN 10	PCB	910759
FM 063 - DN 10	PVT	1003642
FM 063 - DN 10	SST	910756

Spare Diaphragms for Motor-Driven Metering Pump Vario c



pk_2_105_1

	Order no.
Vario with FM 042 Type VAMc 10008, 10016, 07026, 07042	811458
Vario with FM 063 Type VAMc 07012, 07024, 04039, 04063	811459

Accessories

- Foot Valves for Motor-Driven Metering Pumps see page → 1-46
- Injection Valves for Motor-Driven Metering Pumps see page → 1-49
- Connectors and Seals for Motor-Driven Metering Pumps see page → 1-75
- Suction Lances, Suction Assemblies and Level Switches for Motor-Driven Metering Pumps see page → 1-64
- Speed Controllers see page → 1-82
- Thermal metering monitor see page

Spare Parts

- Custom Accessories See page → 1-89



1.2 Motor-Driven Metering Pump Sigma/ 1 (Basic Type)

1.2.1 Motor-Driven Metering Pump Sigma/ 1 (Basic Type)

The robust pump for safe and reliable use

Capacity range 17 – 144 l/h, 12 – 4 bar

The Sigma/ 1 Basic is an extremely robust motor-driven metering pump with patented multi-layer safety diaphragm for excellent process safety. It offers a wide range of power end designs, such as three-phase or 1-phase AC motors, even for Exe and Exde areas with ATEX certification.

The Sigma/ 1 diaphragm metering pump together with pumps of type Sigma/ 2 and Sigma/ 3 represent an integrated product range. They cover the capacity range from 17 to 1,030 l/h, with a consistent operating concept, control concept and spare parts management. A wide range of drive versions is available, including some for use in Exe and Exde areas with ATEX certification.

Your benefits

Excellent process safety and reliability:

- In the event of an accident, the feed chemical does not escape to the outside nor into the pump's power end, thanks to the patented multi-layer safety diaphragm with optical (optionally electric) signalling
- Integrated relief valve protects the pump against overloading
- Reliable operation by bleed option during the suction process

Flexible adaptation to the process:

- The entire Sigma product range is available as standard in a "Physiologically safe in respect of wetted materials" design.
- Metering pumps with electro-polished stainless steel metering head and EHEDG certification enable them to be used in hygienically challenging applications
- Adaptation to specific installation situations, as the "Liquid end on left" is available as standard
- Wide range of power end versions, also for use in Exe and Exde areas and different flange designs for the use of customised motors
- Customised designs are available on request

Technical Details

- Stroke length: 4 mm,
- Stroke length adjustment range: 0 – 100%
- Stroke length adjustment: manually by self-locking rotary dial in 1% increments (optionally with actuator or control drive)
- Metering reproducibility is better than $\pm 2\%$ within the 30-100% stroke length adjustment range under certain defined conditions and after proper installation.
- Wetted materials: PVDF, stainless steel 1.4571/1.4404, special materials on request
- Patented multi-layer safety diaphragm with optical diaphragm rupture display (optionally with diaphragm rupture warning system via a contact)
- Integrated hydraulic relief and bleed valve
- A wide range of power end versions is available: Three-phase standard motor, 1-phase AC motor, motors for use in Exe and Exde areas and different flange designs for use in customer-specific motors
- Degree of protection IP 55 (optionally II2GEEExIIIT3, II2GEEExIIICT4)
- Fibreglass-reinforced plastic housing
- Liquid end on left is available as standard
- For reasons of safety, provide suitable overload protection mechanisms in all mechanically deflected diaphragm metering pumps

Field of application

- Volume-proportional addition of chemicals in water treatment, e.g. sodium-calcium hypochlorite for the disinfection of potable water
- Addition of chemicals depending on the measured value, e.g. metering of acid and alkali for pH neutralisation in waste water treatment
- Time-controlled addition of chemicals in the cooling water circuit
- Pulse-controlled metering in the bottling of different volumes e.g. glycerin filling of manometers

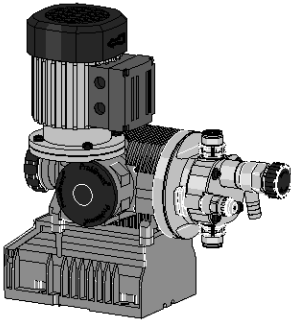

P_SL_0128_SW
Sigma/ 1 Basic version

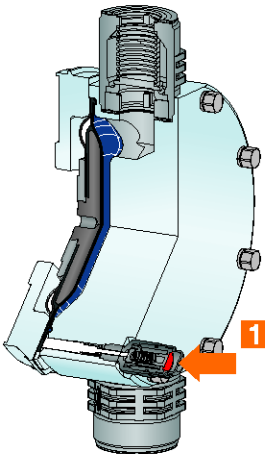

P_SL_0065_C1
1: Diaphragm rupture sensor

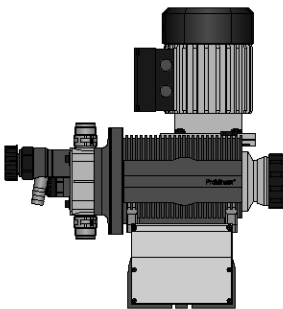

P_SL_0152_SW
Sigma / 1 liquid end on left



1.2 Motor-Driven Metering Pump Sigma/ 1 (Basic Type)

Sigma Basic Type Control Functions (S1Ba)

Stroke length actuator/controller

Actuator for automatic stroke length adjustment, actuating period approx. 1 sec for 1 % stroke length, 1 k Ohm response signal potentiometer, enclosure rating IP 54.

Controller consists of actuator with servomotor and integrated servo control for stroke length adjustment via a standard signal. Standard signal input 0/4-20 mA corresponds to stroke length 0 - 100%. Automatic/manual operation selection key for manual stroke adjustment. Mechanical status display of actual stroke length value output 0/4-20 mA for remote display.

Speed controllers with frequency converter (identity code specification Z)

The speed controller assembly consists of a frequency converter and a variable speed motor of 0.09 kW

"Physiologically Safe (FDA) in Respect of Wetted Materials" Version

All wetted materials in the "Physiologically safe (FDA) in respect of wetted materials" design comply with the FDA guidelines.

FDA guidelines:

- Material PTFE: FDA No. 21 CFR § 177.1550
- Material PVDF: FDA No. 21 CFR § 177.2510

Available for material version PV and SS.

Identity code example: S1BaH04084PV F S000S000

Sigma / 1 Basic Type Version "Liquid End on Left Side"

This version offers additional adaptability to special installation situations, e.g. in combination with storage tanks, brackets, etc.

Identity code example: S1BaH07042PVTS00 5 S000

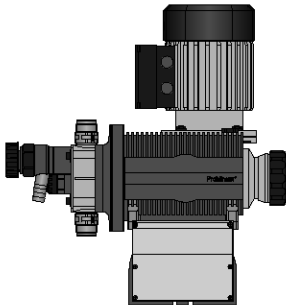

P_SI_0152_SW

Sigma / 1 liquid end on left



1.2 Motor-Driven Metering Pump Sigma/ 1 (Basic Type)

Technical Data

Type S1Ba	With 1500 rpm motor at 50 Hz				With 1800 rpm motor at 60 Hz			Suction lift m WC	Perm. pre- pressure suction side bar	Connection, suction/ discharge side G-DN	Shipping weight kg
	Delivery rate at max. back pressure		Max. stroke rate Strokes/ min	Delivery rate at max. back pressure		Max. stroke rate Strokes/ min					
	l/h bar	ml/ stroke		psi	l/h/gph (US)						
12017 PVT	10	17	3.8	73	174	20.4/5.3	88	7	1	3/4-10	9
12017 SST	12	17	3.8	73	174	20.4/5.3	88	7	1	3/4-10	12
12035 PVT	10	35	4.0	143	174	42.0/11.0	172	7	1	3/4-10	9
12035 SST	12	35	4.0	143	174	42.0/11.0	172	7	1	3/4-10	12
10050 PVT	10	50	4.0	205	145	60.0/15.8	246	7	1	3/4-10	9
10050 SST	10	50	4.0	205	145	60.0/15.8	246	7	1	3/4-10	12
10022 PVT	10	22	5.0	73	145	26.4/6.9	88	6	1	3/4-10	9
10022 SST	10	22	5.0	73	145	26.4/6.9	88	6	1	3/4-10	12
10044 PVT	10	44	5.1	143	145	52.8/13.9	172	6	1	3/4-10	9
10044 SST	10	44	5.1	143	145	52.8/13.9	172	6	1	3/4-10	12
07065 PVT	7	65	5.2	205	102	78.0/20.6	246	6	1	3/4-10	9
07065 SST	7	65	5.2	205	102	78.0/20.6	246	6	1	3/4-10	12
07042 PVT	7	42	9.5	73	102	50.4/13.3	88	3	1	1-15	10
07042 SST	7	42	9.5	73	102	50.4/13.3	88	3	1	1-15	14
04084 PVT	4	84	9.7	143	58	100.8/26.6	172	3	1	1-15	10
04084 SST	4	84	9.7	143	58	100.8/26.6	172	3	1	1-15	14
04120 PVT	4	120	9.7	205	58	144.0/38.0	246	3	1	1-15	10
04120 SST	4	120	9.7	205	58	144.0/38.0	246	3	1	1-15	14

Performance data for TTT, see type PVT

Materials in Contact With the Medium

Material	Dosing head	Suction/pressure connector	Seals/ball seat	Balls	Integral relief valve
PVT	PVDF	PVDF	PTFE/PTFE	Ceramic	PVDF/FKM or EPDM
SST	Stainless steel 1.4404	Stainless steel 1.4581	PTFE/PTFE	Stainless steel 1.4404	Stainless steel/FKM or EPDM
TTT*	PTFE + 25% carbon	PTFE + 25% carbon	PTFE/PTFE	Ceramic	-

* specifically for areas at risk from explosion

With "F" sealing material design – "physiologically safe - FDA", the ball seat is made of PVDF

Motor Data

Identity code specification	Power supply	Δ/Y	Remarks		
S	3-phase, IP 55	220 – 240 V/380 – 420 V	50 Hz	0.09 kW	
		265 – 280 V/440 – 480 V	60 Hz	0.09 kW	
T	3-phase, IP 55	220 – 240 V/380 – 420 V	50 Hz	0.09 kW	with PTC, speed control range 1:5
		265 – 280 V/440 – 480 V	60 Hz	0.09 kW	
R	3-phase, IP 55	220 – 240 V/380 – 420 V	50 Hz	0.09 kW	with PTC, speed adjustment range 1:20 with external fan 1-phase 230 V; 50/60 Hz
M	1-phase AC, IP 55	230 V ± 5 %	50/60 Hz	0.12 kW	
N	1-phase AC, IP 55	115 V ± 5 %	60 Hz	0.12 kW	
L1	3-phase, II2GEElllT3	220 – 240 V/380 – 420 V	50 Hz	0.12 kW	
L2	3-phase, II2GEElllCT4	220 – 240 V/380 – 420 V	50 Hz	0.18 kW	with PTC, speed control range 1:5
P1	3-phase, II2GEElllT3	250 – 280 V/440 – 480 V	60 Hz	0.12 kW	
P2	3-phase, II2GEElllCT4	250 – 280 V/440 – 480 V	60 Hz	0.18 kW	with PTC, speed control range 1:5

Motor data sheets can be requested for more information. Motors for Sigma basic pumps, special motors or special motor flanges are available on request.

Motors less than 0.75 kW and motors designed for speed-controllable operation are not subject to the IE3 standard in compliance with the Ecodesign Directive 2009/125/EC.

Information for use in areas at risk from explosion

Only use pumps with the appropriate labelling in line with the ATEX Directive 94/9/EC in premises at risk from explosion. Ensure that the explosion group, category and degree of protection specified on the label corresponds to or is better than the conditions prevalent in the intended field of application.



1.2 Motor-Driven Metering Pump Sigma/ 1 (Basic Type)

Sigma/ 1 Basic Type (S1Ba)

S1Ba	Drive type					
H	Main drive, diaphragm					
	Pump type					
	bar	l/h		bar	l/h	
12017	12	17	07065	7	65	
12035	12	35	07042	7	42	
10050	10	50	04084	4	84	
10022	10	22	04120	4	120	
10044	10	44				
	Material of liquid end					
PV	PVDF (max. 10 bar)					
SS	Stainless steel					
TT	PTFE + 25% carbon (max. 10 bar)					
	Seal material					
T	PTFE seal					
F	FDA-compliant					
	Diaphragm					
S	Multi-layer safety diaphragm with optical rupture indicator					
A	Multi-layer safety diaphragm with rupture signalling (contact)					
	Liquid end version					
0	No spring					
1	With 2 valve springs, Hastelloy C, 0.1 bar					
4**	With pressure relief valve, FKM seal, no valve spring, only with PV and SS					
5**	With pressure relief valve, FKM seal with valve springs, only with PV and SS					
6**	With pressure relief valve, EPDM seal, without valve spring, only with PV and SS					
7**	With pressure relief valve, EPDM seal, with valve spring, only with PV and SS					
	Hydraulic connection					
0	Standard					
1	Union nut and PVC insert					
2	Union nut and PP insert					
3	Union nut and PVDF insert					
4	Union nut and SS*** insert					
7	Union nut and PVDF hose nozzle					
8	Union nut and SS hose nozzle					
9	Union nut and stainless steel hose nozzle					
	Version					
0	With ProMinent® logo (standard)					
1	Without ProMinent® logo					
M	Modified					
5	Left liquid end					
	Electrical power supply					
S	3 ph, 230 V/400 V 50/60 Hz, 0.09 kW					
T	3 ph, 230 V/400 V 50/60 Hz, with PTC					
R	Variable speed motor 3 ph, 230/400 V, with PTC, with external fan 1 ph 230 V 50/60 Hz					
Z	Speed control compl 1 ph 230 V, 50/60 Hz (variable speed motor + FC)					
M	1 ph, AC, 230 V/50/60 Hz, 0.09 kW					
N	1 ph, AC 115 V 60 Hz, 0.09 kW					
L	3 ph, 230 V/400 V, 50 Hz, (Exe, Exd)					
P	3 ph, 265 V/440 V, 60 Hz, (Exe, Exd)					
2	No motor, C 42 flange (NEMA)					
3	No motor, B 5, size 56 (DIN)					
	Enclosure rating					
0	IP 55 (standard)					
1	Exe motor version ATEX-T3					
2	Exd motor version ATEX-T4					
	Stroke sensor					
0	No stroke sensor (standard)					
2	Pacing relay (reed relay)					
3	Stroke sensor (Namur) for hazardous locations					
	Stroke length adjustment					
0	Manual (standard)					
1	with servomotor, 85...265 V AC 50/60 Hz					
3	with stroke control motor 0...20 mA 85...265 V AC 50/60 Hz					
4	with stroke control motor 4...20 mA 85...265 V AC 50/60 Hz					

* 10 bar with the PVDF and TTT version.

** Standard with tube nozzle in the bypass. Threaded connection on request.

*** Internal thread of insert SS DN10-Rp 3/8, DN15-Rp 1/2

Dosing heads with EGEDG certificate in an electro-polished design (<Ra 0.8) or stainless steel dosing heads with seals according to EU regulation 1935/2004 are available on request.



1.2 Motor-Driven Metering Pump Sigma/ 1 (Basic Type)

1.2.2 Spare Parts

The spare parts kit generally includes the wear parts for the liquid ends.

Scope of delivery with PVT material version:

- 1 diaphragm
- 2 valves, complete
- 2 valve balls
- 2 ball seats
- 4 composite seals
- 1 elastomer sealing set (EPDM, FKM-B)

Scope of delivery with SST material version:

- 1 diaphragm
- 2 valve balls
- 4 complete sealing sets (cover rings, ball seat discs)
- 4 composite seals

Spare Parts Kit for Sigma/ 1 for Design With Multi-layer Safety Diaphragm

(For identity code: Type 12017, 12035, 10050)

Liquid end	Materials in contact with the medium	Order no.
FM 50 - DN 10	PVT	1035964
FM 50 - DN 10	TTT with 2 valves cpl.	1077570
FM 50 - DN 10	SST	1035966
FM 50 - DN 10	SST with 2 valves cpl.	1035965

(For identity code: Type 10022, 10044, 07065)

Liquid end	Materials in contact with the medium	Order no.
FM 65 - DN 10	PVT	1035967
FM 65 - DN 10	TTT with 2 valves cpl.	1077571
FM 65 - DN 10	SST	1035969
FM 65 - DN 10	SST with 2 valves cpl.	1035968

(For identity code: Type 07042, 04084, 04120)

Liquid end	Materials in contact with the medium	Order no.
FM 120 - DN 15	PVT	1035961
FM 120 - DN 15	TTT with 2 valves cpl.	1077572
FM 120 - DN 15	SST	1035963
FM 120 - DN 15	SST with 2 valves cpl.	1035962

Spare Parts Kits for Sigma/ 1 for Design With Old Diaphragm

(For Identity code: Type 12017, 12035, 10050)

Liquid end	Materials in contact with the medium	Order no.
FM 50 - DN 10	PVT	1010541
FM 50 - DN 10	SST	1010554
FM 50 - DN 10	SST with 2 valves cpl.	1010555

(For Identity code: Type 10022, 10044, 07065)

Liquid end	Materials in contact with the medium	Order no.
FM 65 - DN 10	PVT	1010542
FM 65 - DN 10	SST	1010556
FM 65 - DN 10	SST with 2 valves cpl.	1010557

(For Identity code: Type 07042, 04084, 04120)

Liquid end	Materials in contact with the medium	Order no.
FM 120 - DN 15	PVT	1010543
FM 120 - DN 15	SST	1010558
FM 120 - DN 15	SST with 2 valves cpl.	1010559



1.2 Motor-Driven Metering Pump Sigma/ 1 (Basic Type)

Spare Parts Kit for Sigma/ 1 for FDA Design (Physiologically Safe)

(For Identity code: Type 12017, 12035, 10050)

Liquid end	Materials in contact with the medium	Order no.
FM 50 - DN 10	PVT	1046466
FM 50 - DN 10	SST without valve	1046468
FM 50 - DN 10	SST with valve	1046467

(For Identity code: Type 10022, 10044, 07065)

Liquid end	Materials in contact with the medium	Order no.
FM 65 - DN 10	PVT	1046469
FM 65 - DN 10	SST without valve	1046471
FM 65 - DN 10	SST with valve	1046470

(For Identity code: Type 07042, 04084, 04120)

Liquid end	Materials in contact with the medium	Order no.
FM 120 - DN 15	PVT	1046453
FM 120 - DN 15	SST without valve	1046465
FM 120 - DN 15	SST with valve	1046464

Multi-layer Safety Diaphragm (Standard)

Order no.
FM 50 (type 12017; 12035; 10050)
1030114
FM 65 (type 10022; 10044; 07065)
1030115
FM 120 (type 07042; 04084; 04120)
1035828

Metering Diaphragm (Old Version)

Order no.
Sigma/ 1 FM 50 (12017; 12035; 10050)
1010279
Sigma/ 1 FM 65 (10022; 10044; 07065)
1010282
Sigma/ 1 FM 120 (07042; 04084; 04120)
1010285

Spare Parts Kits for Integrated Relief Valve

Consisting of two compression springs made from Hastelloy C and four FKM-A and EPDM O-rings each

	For material	Seals	Order no.
Spare parts kits for integrated relief valve 4 bar	PVT/SST	FKM-A/EPDM	1031199
Spare parts kits for integrated relief valve 7 bar	PVT/SST	FKM-A/EPDM	1031200
Spare parts kits for integrated relief valve 10 bar	PVT/SST	FKM-A/EPDM	1031201
Spare parts kits for integrated relief valve 12 bar	PVT/SST	FKM-A/EPDM	1031202

Accessories

- Foot Valves see page → 1-46
- Injection Valves see page → 1-49
- Connector Parts, Seals, Hoses see page → 1-75
- Suction Lances/Suction Assemblies see page → 1-64
- Speed Controllers see page → 1-82
- Dosierüberwachung - Mengenummessung see page

Spare Parts

- Custom Accessories See page → 1-89



1.3 Motor-Driven Metering Pump Sigma/ 1 (Control Type)

1.3.1 Motor-Driven Metering Pump Sigma/ 1 (Control Type)

The intelligent pump for safe and reliable use in many applications.

Capacity range 17 – 117 l/h, 12 – 4 bar

The Sigma / 1 Control can be used flexibly as an extremely robust motor-driven diaphragm metering pump. Excellent process safety and reliability is guaranteed with the patented multi-layer safety diaphragm. Highlights include removable control unit, adjustable metering profiles, as well as a variety of power end and control configurations.

The Sigma/ 1 Control diaphragm metering pump together with pumps of type Sigma/ 2 Control and Sigma/ 3 Control represent an integrated product range. They cover the capacity range from 17 to 1,040 l/h. The entire Sigma Control product range is equipped with intelligent features to provide a high level of operating convenience, safety and efficiency. The pump features a removable operating unit and adjustable metering profiles to ensure optimum metering results.

Your benefits

Excellent process safety and reliability:

- In the event of an accident, the feed chemical does not escape to the outside nor into the pump's power end, thanks to the patented multi-layer safety diaphragm with optical (optionally electric) signalling.
- Integrated relief valve protects the pump against overloading and reliable operation by bleed option during the discharge process.
- Metering reproducibility is better than $\pm 2\%$ with a 30 - 100 % stroke length adjustment range under certain defined conditions and with proper installation.

Flexible adaptation to the process:

- Detachable operating unit with large illuminated LC display for outstanding user convenience.
- Metering profiles for optimum metering results.
- The Sigma product range is available in a "Physiologically safe in respect of wetted materials" design and with electro-polished stainless steel dosing head and EHEDG certification for applications with strict hygiene requirements.
- Different control options are available, as well as easy connection to bus-networked systems by PROFIBUS®. Connection of PROFIBUS applications using the ProMinent DULConvert PROFIBUS®-PROFINET converter.
- Adaptation to specific installation situations, as the "Liquid end on left" option is available as standard.
- Customised designs are available on request.

Technical Details

- Stroke length: 4 mm,
- Stroke length adjustment range: 0 – 100%
- Stroke length adjustment: manually using self-locking rotary dial in 1% increments
- Metering reproducibility is better than $\pm 2\%$ in the 30 – 100% stroke length adjustment range under defined conditions and with correct installation
- Wetted materials: PVDF, stainless steel 1.4571/1.4404, special materials on request
- Patented multi-layer safety diaphragm with optical diaphragm rupture display (optionally with diaphragm rupture warning system via a contact)
- Integrated hydraulic relief and bleed valve
- Removable operating unit (HMI) with large illuminated LC display
- Metering profiles for optimum metering results
- Power supply: 1-phase, 100 – 230 V $\pm 10\%$, 240 V $\pm 6\%$, 50/60 Hz (110 W)
- Degree of protection IP 65
- Fibreglass-reinforced plastic housing
- Liquid end on left is available as standard
- For reasons of safety, provide suitable overload protection mechanisms in all mechanically deflected diaphragm metering pumps.

Field of application

- Volume-proportional addition of chemicals in water treatment, e.g. sodium-calcium hypochlorite for the disinfection of potable water
- Neutralisation in waste water treatment
- Time-controlled addition of chemicals in the cooling water circuit
- Pulse-controlled metering in the bottling of different volumes e.g. glycerin filling of manometers

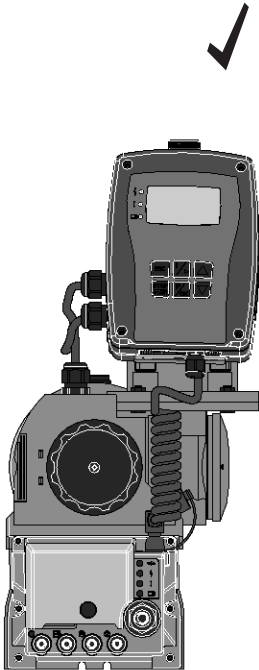

P_SI_0129_SW
Sigma/ 1 control type

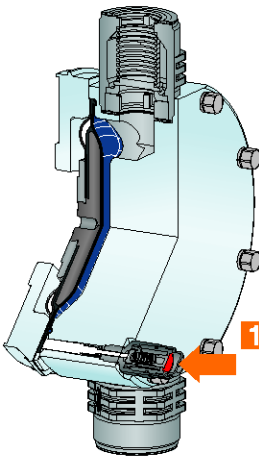

P_SI_0065_C1
1: Diaphragm rupture sensor

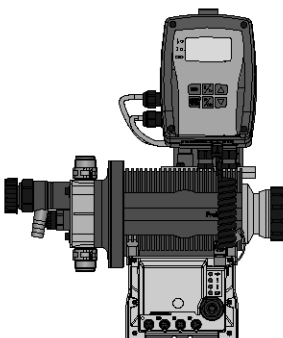

P_SI_0153_SW
Sigma / 1 Control type design, liquid end on left



1.3 Motor-Driven Metering Pump Sigma/ 1 (Control Type)



P_SI_0099_SW3

Detachable Operating Unit (HMI)

The operating unit (HMI) can be attached directly to the metering pump or mounted on the wall alongside the pump. This provides the operator with a range of options for the integration of a metering system in the overall system that it is readily accessible and easy to use. Moreover the removable operating unit offers additional protection against unauthorised operation of the metering pump or against modification of the pump settings. The operating unit can, for example, be completely removed for project applications.

Individual functions of the metering pump can be easily selected and adjusted with five program keys. An illuminated LCD display provides information about the relevant operating status. LEDs on the operating unit and the control unit indicate the active pump functions or the pump status.

Metering Profiles

Metering profiles guarantee optimum metering results by adapting the metering behaviour of the metering pump to the application or chemical used.

The stroke motion of the displacement body is continually recorded and regulated so that the stroke is made in line with the desired metering profile. The pump can be operated in normal mode (Diagram 1), with optimised discharge stroke (Diagram 2) or with optimised suction stroke (Diagram 3). Three typical metering profiles are shown schematically with the behaviour over time.

In normal operating mode (standard), the time behaviour for the suction stroke and the discharge stroke is similar (Diagram 1). In the mode with optimised discharge stroke (Diagram 2), the discharge stroke is lengthened while the suction stroke is made as quickly as possible. This set-up is suited to applications which require optimum mixing and as continuous a mixing of chemicals as possible, for example.

In the mode with the optimised suction stroke (diagram 3), the suction stroke is carried out as slowly as possible, permitting precise and trouble-free metering of viscous and gaseous media. Select this setting to minimise the NPSH value as well.

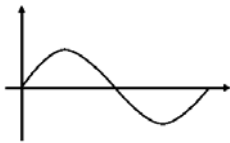

P_SI_0102_SW

Diagram 1: Discharge stroke, suction stroke equal

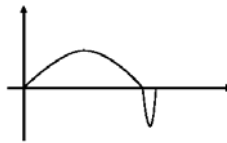

P_SI_0103_SW

Diagram 2: Long discharge stroke, short suction stroke

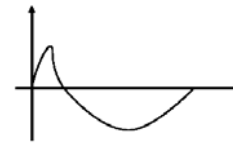

P_SI_0104_SW

Diagram 3: Short discharge stroke, long suction stroke

"Physiologically Safe (FDA) in Respect of Wetted Materials" Version

All wetted materials in the "Physiologically safe (FDA) in respect of wetted materials" design comply with the FDA guidelines (Version F).

FDA guidelines:

- Material PTFE: FDA No. 21 CFR § 177.1550
- Material PVDF: FDA No. 21 CFR § 177.2510

Available for material version PV and SS.

Identity code example: S1CbH07042PV F S010S0DE .

Sigma / 1 Control Type Version "Liquid End on Left Side"

This version offers additional adaptability to special installation situations, e.g. in combination with storage tanks, brackets, etc.

Identity code example: S1CbH07042PVTS01 5 UA10S0DE

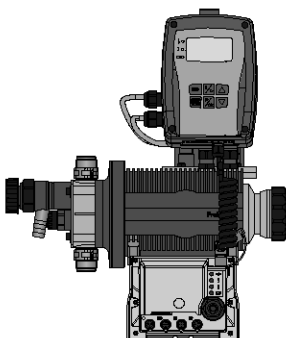

P_SI_0153_SW

Sigma / 1 Control type design, liquid end on left

1.3 Motor-Driven Metering Pump Sigma/ 1 (Control Type)

Technical Data

Type S1Cb	Delivery rate at max. back pressure			Max. stroke rate Strokes/min	Delivery rate at max. back pressure		Suction lift m WC	Perm. pre-pressure suction side bar	Connection, suction/discharge side G-DN	Shipping weight kg
	bar	l/h	ml/stroke		psi	gph (US)				
12017 PVT	10	21	3.8	90	145	5.5	7	1	3/4-10	9
12017 SST	12	21	3.8	90	174	5.5	7	1	3/4-10	12
12035 PVT	10	42	4.0	170	145	11.1	7	1	3/4-10	9
12035 SST	12	42	4.0	170	174	11.1	7	1	3/4-10	12
10050 PVT	10	49	4.0	200	145	12.9	7	1	3/4-10	9
10050 SST	10	49	4.0	200	145	12.9	7	1	3/4-10	12
10022 PVT	10	27	5.0	90	145	7.1	6	1	3/4-10	9
10022 SST	10	27	5.0	90	145	7.1	6	1	3/4-10	12
10044 PVT	10	53	5.1	170	145	14.0	6	1	3/4-10	9
10044 SST	10	53	5.1	170	145	14.0	6	1	3/4-10	12
07065 PVT	7	63	5.2	200	102	16.6	6	1	3/4-10	9
07065 SST	7	63	5.2	200	102	16.6	6	1	3/4-10	12
07042 PVT	7	52	9.5	90	102	13.7	3	1	1-15	10
07042 SST	7	52	9.5	90	102	13.7	3	1	1-15	14
04084 PVT	4	101	9.7	170	58	26.7	3	1	1-15	10
04084 SST	4	101	9.7	170	58	26.7	3	1	1-15	14
04120 PVT	4	117	9.7	200	58	30.9	3	1	1-15	10
04120 SST	4	117	9.7	200	58	30.9	3	1	1-15	14

Materials in Contact With the Medium

Material	Dosing head	Suction/pressure connector	Seals/ball seat	Balls	Integral relief valve
PVT	PVDF	PVDF	PTFE/PTFE	Ceramic	PVDF/FKM or EPDM
SST	Stainless steel 1.4404	Stainless steel 1.4581	PTFE/PTFE	Stainless steel 1.4404	Stainless steel/FKM or EPDM

With "F" sealing material design – "physiologically safe - FDA", the ball seat is made of PVDF

Motor Data

Identity code specification	Power supply	Remarks
U	1-phase, IP 65 100 – 230 V ±10 % / 240 V ±6 % 50/60 Hz	110 W

Motors less than 0.75 kW and motors designed for speed-controllable operation are not subject to the IE3 standard in compliance with the Ecodesign Directive 2009/125/EC.



1.3 Motor-Driven Metering Pump Sigma/ 1 (Control Type)

Sigma/ 1 Control Type (S1Cb)

S1Cb	Drive type	H Main power end, diaphragm									
	Pump type										
		bar	l/h		bar	l/h		bar	l/h		
	12017	12	21	10022	10	27	07042	7	52		
	12035	12	42	10044	10	53	04084	4	101		
	10050	10	49	07065	7	63	04120	4	117		
	Dosing head material										
	PV	PVDF (max. 10 bar)									
	SS	Stainless steel									
	Seal material										
	T	PTFE seal			F	FDA-compliant					
	Displacement body										
	S	Multi-layer safety diaphragm with optical rupture indicator									
	A	Multi-layer safety diaphragm with electrical signal									
	Dosing head version										
	0	no valve spring (standard)									
	1	with 2 valve springs, Hastelloy C; 0.1 bar									
	2	with bleed valve, FKM seal, no valve spring									
	3	with bleed valve, FKM seal, with valve spring									
	4**	with relief valve, FPM seal, no valve springs									
	5**	with relief valve, FPM seal, with valve springs									
	6**	with relief valve, EPDM seal, no valve springs									
	7**	with relief valve, EPDM seal, with valve springs									
	8	with bleed valve, EPDM seal, no valve spring									
	9	with bleed valve, EPDM seal, with valve spring									
	Hydraulic connector										
	0	Standard connection									
	1	Union nut and PVC insert									
	2	Union nut and PP insert									
	3	Union nut and PVDF insert									
	4	Union nut and stainless steel*** insert									
	7	Union nut and PVDF tube nozzle									
	8	Union nut and stainless steel tube nozzle									
	9	Union nut and stainless steel welding sleeve									
	Version										
	0	With ProMinent® Logo									
	1	Without ProMinent® Logo									
	5	Left liquid end									
	Electric power supply										
	U	1 ph, 100 – 230 V ±10%, 240 V ±6%, 50/60 Hz, 110 W									
	Cable and plug										
	A	2 m Europe			C	2 m Australia					
	B	2 m Swiss			D	2 m USA					
	Relay										
	0	No relay									
	1	Fault indicating relay (230 V, 8 A)									
	3	Fault indicating relay (24 V, 100 mA) + pacing relay (24 V, 100 mA)									
	8	0/4-20 mA analogue output + fault indicating / pacing relay (24 V - 100 mA)									
	Control versions										
	0	Manual + external contact with pulse control									
	1	as 0 + analogue + metering profiles									
	6	as 1 + PROFIBUS® DP interface, M 12									
	7	as 1 + CANopen (CiA 402, M12 plug), pump without operating unit (HMI) ****									
	Overload switch-off										
	0	without overload switch-off									
	Operating unit (HMI)										
	S	HMI (0.5 m cable)									
	1	HMI + 2 m cable									
	2	HMI + 5 m cable									
	3	HMI + 10 m cable									
	X	without operating unit (HMI)									
	Access code										
	0	without access control									
	1	with access control									

* 10 bar with PVDF version.

** Standard with tube nozzle in the bypass. Threaded connection on request.

*** Internal thread of insert SS DN10-Rp 3/8, DN15-Rp 1/2

**** An HMI order no. 1042550 is required for manual operation, e.g. with the failure of the CAN bus

Dosing heads with EGEDG certificate in an electro-polished design (<Ra 0.8) or stainless steel dosing heads with seals according to EU regulation 1935/2004 are available on request.

1



1.3 Motor-Driven Metering Pump Sigma/ 1 (Control Type)

1.3.2 Spare Parts

The spare parts kit generally includes the wear parts for the liquid ends.

Scope of delivery with PVT material version:

- 1 diaphragm
- 2 valves, complete
- 2 valve balls
- 2 ball seats
- 4 composite seals
- 1 elastomer sealing set (EPDM, FKM-B)

Scope of delivery with SST material version:

- 1 diaphragm
- 2 valve balls
- 4 complete sealing sets (cover rings, ball seat discs)
- 4 composite seals

Spare Parts Kit for Sigma/ 1 for Design With Multi-layer Safety Diaphragm

(For identity code: Type 12017, 12035, 10050)

Liquid end	Materials in contact with the medium	Order no.
FM 50 - DN 10	PVT	1035964
FM 50 - DN 10	SST	1035966
FM 50 - DN 10	SST with 2 valves cpl.	1035965

(For identity code: Type 10022, 10044, 07065)

Liquid end	Materials in contact with the medium	Order no.
FM 65 - DN 10	PVT	1035967
FM 65 - DN 10	SST	1035969
FM 65 - DN 10	SST with 2 valves cpl.	1035968

(For identity code: Type 07042, 04084, 04120)

Liquid end	Materials in contact with the medium	Order no.
FM 120 - DN 15	PVT	1035961
FM 120 - DN 15	SST	1035963
FM 120 - DN 15	SST with 2 valves cpl.	1035962

Spare Parts Kits for Sigma/ 1 for Design With Old Diaphragm

(For Identity code: Type 12017, 12035, 10050)

Liquid end	Materials in contact with the medium	Order no.
FM 50 - DN 10	PVT	1010541
FM 50 - DN 10	SST	1010554
FM 50 - DN 10	SST with 2 valves cpl.	1010555

(For Identity code: Type 10022, 10044, 07065)

Liquid end	Materials in contact with the medium	Order no.
FM 65 - DN 10	PVT	1010542
FM 65 - DN 10	SST	1010556
FM 65 - DN 10	SST with 2 valves cpl.	1010557

(For Identity code: Type 07042, 04084, 04120)

Liquid end	Materials in contact with the medium	Order no.
FM 120 - DN 15	PVT	1010543
FM 120 - DN 15	SST	1010558
FM 120 - DN 15	SST with 2 valves cpl.	1010559



1.3 Motor-Driven Metering Pump Sigma/ 1 (Control Type)

Spare Parts Kit for Sigma/ 1 for FDA Design (Physiologically Safe)

(For Identity code: Type 12017, 12035, 10050)

Liquid end	Materials in contact with the medium	Order no.
FM 50 - DN 10	PVT	1046466
FM 50 - DN 10	SST without valve	1046468
FM 50 - DN 10	SST with valve	1046467

(For Identity code: Type 10022, 10044, 07065)

Liquid end	Materials in contact with the medium	Order no.
FM 65 - DN 10	PVT	1046469
FM 65 - DN 10	SST without valve	1046471
FM 65 - DN 10	SST with valve	1046470

(For Identity code: Type 07042, 04084, 04120)

Liquid end	Materials in contact with the medium	Order no.
FM 120 - DN 15	PVT	1046453
FM 120 - DN 15	SST without valve	1046465
FM 120 - DN 15	SST with valve	1046464

Spare Parts Kits for Integrated Relief Valve (S1Ca, S1Cb)

Consisting of two compression springs made from Hastelloy C and four FKM-A and EPDM O-rings each

	For material	Seals	Order no.
Spare parts kits for integrated relief valve 4 bar	PVT/SST	FKM-A/EPDM	1031199
Spare parts kits for integrated relief valve 7 bar	PVT/SST	FKM-A/EPDM	1031200
Spare parts kits for integrated relief valve 10 bar	PVT/SST	FKM-A/EPDM	1031201
Spare parts kits for integrated relief valve 12 bar	PVT/SST	FKM-A/EPDM	1031202

Spare Parts Kits for Integrated Bleed Valve (S1Cb)

Consisting of a compression spring made from Hastelloy C and four FKM-A and EPDM O-rings each

For identity code specification "Dosing head version" with characteristic "2", "3", "8", "9"

	For material	Seals	Order no.
ETS	PVT/SST	FKM-A/EPDM	1043785

Multi-layer Safety Diaphragm (Standard)

	Order no.
FM 50 (type 12017; 12035; 10050)	1030114
FM 65 (type 10022; 10044; 07065)	1030115
FM 120 (type 07042; 04084; 04120)	1035828

Metering Diaphragm (Old Version)

	Order no.
Sigma/ 1 FM 50 (12017; 12035; 10050)	1010279
Sigma/ 1 FM 65 (10022; 10044; 07065)	1010282
Sigma/ 1 FM 120 (07042; 04084; 04120)	1010285



1.3 Motor-Driven Metering Pump Sigma/ 1 (Control Type)

Spare Parts Kits for Integrated Relief Valve

Consisting of two compression springs made from Hastelloy C and four FKM-A and EPDM O-rings each

	For material	Seals	Order no.
Spare parts kits for integrated relief valve 4 bar	PVT/SST	FKM-A/EPDM	1031199
Spare parts kits for integrated relief valve 7 bar	PVT/SST	FKM-A/EPDM	1031200
Spare parts kits for integrated relief valve 10 bar	PVT/SST	FKM-A/EPDM	1031201
Spare parts kits for integrated relief valve 12 bar	PVT/SST	FKM-A/EPDM	1031202

Protective cowling

Protection of the operating unit (HMI) of Sigma metering pumps against contamination; made from transparent silicone plastic. For Sigma control types S1Cb / S2Cb / S3Cb.

	Order no.
Protective cowling for operating unit (S1Cb, S2Cb, S3Cb)	1036724

Wall bracket

Wall bracket with operating lever for wall mounting of the operating unit (HMI) without any fittings. For Sigma control types S1Cb / S2Cb / S3Cb.

	Order no.
Wall bracket for operating unit (S1Cb, S2Cb, S3Cb)	1036683

Extension cable for operating unit (HMI)

	Order no.
Connecting cable - CAN M12 5-pole 1 m	1022139
Connecting cable - CAN M12 5-pole 2 m	1022140
Connecting cable - CAN M12 5-pole 5 m	1022141
Connecting cable - CAN M12 5-pin. 10 m*	1046383

Accessories of CANopen operation

An operating unit is needed for the manual operation of a CANopen pump.

	Order no.
Operating unit (HMI)	1042550

Accessories

- Foot Valves see page → 1-46
- Injection Valves see page → 1-49
- Connector Parts, Seals, Hoses see page → 1-75
- Suction Lances/Suction Assemblies see page → 1-64
- Dossierüberwachung - Mengenmessung see page

Spare Parts

- Custom Accessories See page → 1-89



1.4 Motor-Driven Metering Pump Sigma/ 2 (Basic Type)

1.4.1 Motor-Driven Metering Pump Sigma/ 2 (Basic Type)

The robust pump for safe and reliable use.

Capacity range 50 – 420 l/h, 16 – 4 bar

Robust motor-driven diaphragm metering pumps, like the Sigma/ 2 Basic guarantee excellent process reliability with their patented multi-layer safety diaphragm. The diaphragm metering pump offers a wide range of power end versions, even for Exe and Exde areas with ATEX certification.

The Sigma/ 2 diaphragm metering pump together with pumps of type Sigma/ 1 and Sigma/ 3 represent an integrated product range. They cover the capacity range from 17 to 1,030 l/h, with a consistent operating concept, control concept and spare parts management. A wide range of drive versions is available, including some for use in Exe and Exde areas with ATEX certification.

Your benefits

Excellent process safety and reliability:

- In the event of an accident, the feed chemical does not escape to the outside nor into the pump's power end, thanks to the patented multi-layer safety diaphragm with optical (optionally electric) signalling
- Integrated relief valve protects the pump against overloading
- Reliable operation by bleed option during the suction process

Flexible adaptation to the process:

- The Sigma product range is available as standard in the "Physiologically safe in respect of wetted materials" "F" design.
- Metering pumps with electro-polished stainless steel metering head and EHEDG certification enable them to be used in hygienically challenging applications
- Wide range of power end versions, also for use in Exe and Exde areas, and different flange designs for the use of customised motors
- Customised designs are available on request

Technical Details

- Stroke length: 5 mm,
- Stroke length adjustment range: 0 – 100%
- Stroke length adjustment: manually by self-locking rotary dial in 1% increments (optionally with actuator or control drive)
- Metering reproducibility is better than $\pm 2\%$ with a 30-100% stroke length adjustment range under certain defined conditions and with proper installation.
- Wetted materials: PVDF, stainless steel 1.4571/1.4404, special materials on request
- Patented multi-layer safety diaphragm with optical diaphragm rupture display (optionally with diaphragm rupture warning system via a contact)
- Integrated hydraulic relief and bleed valve
- A wide range of power end versions is available: Three-phase standard motor, 1-phase AC motor, motors for use in Exe and Exde areas and different flange designs for use in customer-specific motors
- Degree of protection IP 55 (optionally II2GExeIIIT3, II2GExdIICT4)
- Highly rigid fibreglass-reinforced plastic housing with excellent chemical resistance
- For reasons of safety, provide suitable overload protection mechanisms in all mechanically deflected diaphragm metering pumps.

Field of application

- Volume-proportional addition of chemicals in water treatment, e.g. sodium-calcium hypochlorite for the disinfection of potable water
- Addition of chemicals depending on the measured value, e.g. metering of acid and alkali for pH neutralisation in waste water treatment
- Time-controlled addition of chemicals in the cooling water circuit
- Pulse-controlled metering in the bottling of different volumes e.g. glycerin filling of manometers

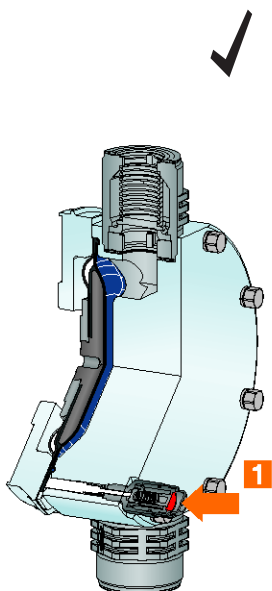

P_SI_0065_C1

1: Diaphragm rupture sensor

1.4 Motor-Driven Metering Pump Sigma/ 2 (Basic Type)

Sigma Basic Type Control Functions (S2Ba)

Stroke length actuator/controller

Actuator for automatic stroke length adjustment, actuating period approx. 1 sec for 1 % stroke length, 1 k Ohm response signal potentiometer, enclosure rating IP 54.

Controller consists of actuator with servomotor and integrated servo control for stroke length adjustment via a standard signal. Standard signal input 0/4-20 mA corresponds to stroke length 0 - 100%. Automatic/manual operation selection key for manual stroke adjustment. Mechanical status display of actual stroke length value output 0/4-20 mA for remote display.

Speed controllers with frequency converter (identity code specification Z)

The speed controller assembly consists of a frequency converter and a variable speed motor of 0.37 kW.

"Physiologically Safe (FDA) in Respect of Wetted Materials" Version

All wetted materials in the "Physiologically safe (FDA) in respect of wetted materials" design comply with the FDA guidelines.

FDA guidelines:

- Material PTFE: FDA-No. 21 CFR § 177.1550
- Material PVDF: FDA-No. 21 CFR § 177.2510

Available for material version PV and SS.

Identity code example: S2BaHM07220PV F S000S000



1.4 Motor-Driven Metering Pump Sigma/ 2 (Basic Type)

Technical Data

Type S2Ba	With 1500 rpm motor at 50 Hz				With 1800 rpm motor at 60 Hz				Suction lift m WC	Perm. pre- pressure suction side bar	Connection suction/ discharge side G-DN	Shipping weight kg
	Delivery rate at max. back pressure		Max. stroke rate Strokes/ min	Delivery rate at max. back pressure		Max. stroke rate Strokes/ min						
bar	l/h	ml/ stroke		psi	l/h/gph (US)							
16050 PVT	10	50	11.4	73	145	60.0/15.8	87	7	3	1-15	15	
16050 SST	16	47	11.4	73	232	56.0/14.7	87	7	3	1-15	20	
16090 PVT	10	88	11.4	132	145	106.0/28.0	158	7	3	1-15	15	
16090 SST	16	82	11.4	132	232	98.4/25.9	158	7	3	1-15	20	
16130 PVT	10	135	10.9	198	145	156.0/41.2	238	7	3	1-15	15	
16130 SST	16	124	10.9	198	232	148.0/39.0	238	7	3	1-15	20	
07120 PVT	7	126	27.4	73	102	150.0/39.6	87	5	1	1 1/2-25*	16	
07120 SST	7	126	27.4	73	102	150.0/39.6	87	5	1	1 1/2-25*	24	
07220 PVT	7	220	27.7	132	102	264.0/69.7	158	5	1	1 1/2-25*	16	
07220 SST	7	220	27.7	132	102	264.0/69.7	158	5	1	1 1/2-25*	24	
04350 PVT	4	350	29.4	198	58	420.0/110.9	238	5	1	1 1/2-25*	16	
04350 SST	4	350	29.4	198	58	420.0/110.9	238	5	1	1 1/2-25*	24	

Performance data for TTT, see type PVT

* With Sigma types 07120, 07220 and 04350, the dosing head is fitted with DN 25 (G 1 1/2) valves. As DN 20 is generally sufficient for these types of pipes (see technical data, suction/discharge side connector), the connector parts that can be ordered under the identity code (e.g. inserts) are already reduced to DN 20, i.e. piping and accessories can be installed in DN 20.

Materials in Contact With the Medium

Material	Dosing head	Suction/pressure connector	Seals/ball seat	Balls	Integral relief valve
PVT	PVDF	PVDF	PTFE/PTFE	Ceramic/glass*	PVDF/FKM or EPDM
SST	Stainless steel 1.4404	Stainless steel 1.4581	PTFE/PTFE	Stainless steel 1.4404	Stainless steel/FKM or EPDM
TTT**	PTFE + 25% carbon	PTFE + 25% carbon	PTFE/PTFE	Ceramic/glass*	-

* with 07120, 07220, 04350

** specifically for areas at risk from explosion

With "F" sealing material design – "physiologically safe - FDA", the ball seat is made of PVDF

Motor Data

Identity code specification	Power supply	Δ/Y	Remarks
S	3-phase, IP 55	220 – 240 V/380 – 420 V	50 Hz 0.25 kW
		220 – 280 V/440 – 480 V	60 Hz 0.25 kW
T	3-phase, IP 55	220 – 240 V/380 – 420 V	50 Hz 0.25 kW with PTC, speed control range 1:5
		220 – 280 V/440 – 480 V	60 Hz
R	3-phase, IP 55	220 – 240 V/380 – 420 V	50 Hz 0.37 kW with PTC, speed adjustment range 1:20 with external fan 1ph 230 V; 50/60 Hz
M	1-phase AC, IP 55	230 V ± 5 %	50/60 Hz 0.18 kW
N	1-phase AC, IP 55	115 V ± 5 %	60 Hz 0.18 kW
L1	3-phase, II2GEEexIIIT3	220 – 240 V/380 – 420 V	50 Hz 0.18 kW
L2	3-phase, II2GEEexdIICT4	220 – 240 V/380 – 420 V	50 Hz 0.18 kW with PTC, speed control range 1:5
P1	3-phase, II2GEEexIIIT3	250 – 280 V/440 – 480 V	60 Hz 0.18 kW
P2	3-phase, II2GEEexdIICT4	250 – 280 V/440 – 480 V	60 Hz 0.21 kW with PTC, speed control range 1:5

Motor data sheets can be requested for more information. Motors for Sigma basic pumps, special motors or special motor flanges are available on request.

Motors less than 0.75 kW and motors designed for speed-controllable operation are not subject to the IE3 standard in compliance with the Ecodesign Directive 2009/125/EC.

Information for use in areas at risk from explosion

Only use pumps with the appropriate labelling in line with the ATEX Directive 94/9/EC in premises at risk from explosion. Ensure that the explosion group, category and degree of protection specified on the label corresponds to or is better than the conditions prevalent in the intended field of application.

1.4 Motor-Driven Metering Pump Sigma/ 2 (Basic Type)

Sigma/ 2 Basic Type (S2Ba)

S2Ba	Drive type					
	HM	Main drive, diaphragm				
	Pump type					
		bar	l/h		bar	l/h
	16050	16	47	07120	7	126
	16090	16	82	07220	7	220
	16130	16	124	04350	4	350
	Liquid end material					
	PV	PVDF (max. 10 bar)				
	SS	Stainless steel				
	TT	PTFE + 25% carbon (max. 10 bar)				
	Seal material					
	T	PTFE seal				
	F	FDA-compliant				
	Diaphragm					
	S	Multi-layer safety diaphragm with optical rupture indicator				
	A	Multi-layer safety diaphragm with rupture signalling (contact)				
	Liquid end version					
	0	No spring				
	1	With 2 valve springs, Hastelloy C4, 0.1 bar				
	4**	With pressure relief valve, FKM seal, no valve spring, only with PV and SS				
	5**	With pressure relief valve, FKM seal with valve springs, only with PV and SS				
	6**	With pressure relief valve, EPDM seal, without valve spring, only with PV and SS				
	7**	With pressure relief valve, EPDM seal, with valve spring, only with PV and SS				
	Hydraulic connection					
	0	Standard				
	1	Union nut and PVC insert				
	2	Union nut and PP insert				
	3	Union nut and PVDF insert				
	4	Union nut and SS*** insert				
	7	Union nut and PVDF hose nozzle				
	8	Union nut and SS hose nozzle				
	9	Union nut and stainless steel hose nozzle				
	Version					
	0	With ProMinent® logo (standard)				
	1	Without ProMinent® logo				
	M	Modified				
	Electrical power supply					
	S	3 ph, 230 V/400 V 50/60 Hz				
	T	3 ph, 230 V/400 V 50/60 Hz, with PTC				
	R	Variable speed motor 3 ph, 230/400 V, with PTC, with external fan 1 ph 230 V 50/60 Hz				
	Z	Speed control compl 1 ph 230 V, 50/60 Hz (variable speed motor + FC)				
	M	1 ph, AC, 230 V/50/60 Hz				
	N	1 ph, AC, 115 V, 60 Hz				
	L	3 ph, 230 V/400 V, 50 Hz, (Exe, Exd)				
	P	3 ph, 265 V/440 V, 60 Hz, (Exe, Exd)				
	1	No motor, with B14 flange, Gr. 71 DIN				
	2	No motor, with flange NEMA 56 C				
	3	No motor, with B5 flange, Gr. 63 DIN				
	Enclosure rating					
	0	IP 55 (standard)				
	1	Exe motor version ATEX-T3				
	2	Exd motor version ATEX-T4				
	Stroke sensor					
	0	No stroke sensor (standard)				
	2	Pacing relay (reed relay)				
	3	Stroke sensor (Namur) for hazardous locations				
	Stroke length adjustment					
	0	Manual (standard)				
	1	with servomotor, 85...265 V AC 50/60 Hz				
	3	with stroke control motor 0...20 mA 85...265 V AC 50/60 Hz				
	4	with stroke control motor 4...20 mA 85...265 V AC 50/60 Hz				

* 10 bar with the PVDF and TTT version.

** Standard with tube nozzle in the bypass. Threaded connection on request.

*** Internal thread of the insert SS DN15-Rp 1/2, DN25/20-G 3/4

Dosing heads with EGEDG certificate in an electro-polished design (<Ra 0.8) or stainless steel dosing heads with seals according to EU regulation 1935/2004 are available on request.



1.4 Motor-Driven Metering Pump Sigma/ 2 (Basic Type)

1.4.2 Spare Parts

The spare parts kit generally includes the wear parts for the liquid ends.

Scope of delivery with PVT material version:

- 1 diaphragm
- 2 valves, complete
- 2 valve balls
- 2 ball seats
- 4 composite seals
- 1 elastomer sealing set (EPDM, FKM-B)

Scope of delivery with SST material version:

- 1 diaphragm
- 2 valve balls
- 2 ball seat discs
- 4 composite seals

Spare Parts Kit for Sigma/ 2 for Design With Multi-layer Safety Diaphragm

(Applies to identity code types 16050, 16090, 16130, 12050, 12090 and 12130)

Liquid end	Materials in contact with the medium	Order no.
FM 130 - DN 15	PVT	1035951
FM 130 - DN 15	TTT with 2 valves cpl.	1077573
FM 130 - DN 15	SST	1035957
FM 130 - DN 15	SST with 2 valves cpl.	1035954

(Applies to identity code types 07120, 07220 and 04350)

Liquid end	Materials in contact with the medium	Order no.
FM 350 - DN 25	PVT	1035953
FM 350 - DN 25	TTT with 2 valves cpl.	1077574
FM 350 - DN 25	SST	1035960
FM 350 - DN 25	SST with 2 valves cpl.	1035959

Spare Parts Kits for Sigma/ 2 for Design With Old Diaphragm

(Applies to identity code types 16050, 16090, 16130, 12050, 12090 and 12130)

Liquid end	Materials in contact with the medium	Order no.
FM 130 - DN 15	PVT	740324
FM 130 - DN 15	SST	740326
FM 130 - DN 15	SST with 2 valves cpl.	740328

(Applies to identity code types 07120, 07220 and 04350)

Liquid end	Materials in contact with the medium	Order no.
FM 350 - DN 25	PVT	740325
FM 350 - DN 25	SST	740327
FM 350 - DN 25	SST with 2 valves cpl.	740329



1.4 Motor-Driven Metering Pump Sigma/ 2 (Basic Type)

Spare Parts Kits for Sigma/ 2 With FDA Design (Physiologically Safe)

(Applies to identity code types 16050, 16090, 16130, 12050, 12090 and 12130)

Liquid end	Materials in contact with the medium	Order no.
FM 130 - DN 15	PVT	1046472
FM 130 - DN 15	SST without valve	1046473
FM 130 - DN 15	SST with valve	1046474

(Applies to identity code types 07120, 07220 and 04350)

Liquid end	Materials in contact with the medium	Order no.
FM 350 - DN 25	PVT	1046475
FM 350 - DN 25	SST without valve	1046476
FM 350 - DN 25	SST with valve	1046477

Multi-layer Safety Diaphragm (Standard)

	Order no.
FM 130 (type: 16050, 16090, 16130)	1029771
FM 350 (type: 07120, 07220, 04350)	1033422

Metering Diaphragm (Old Version)

	Order no.
Sigma with FM 130 identity code: Type 16050, 16090, 16130	792495
Sigma with FM 350 identity code: Type 07120, 07220, 04350	792496

Spare Parts Kits for Integrated Relief Valve

Consisting of two compression springs made from Hastelloy C and four FKM-A and EPDM O-rings each

	For material	Seals	Order no.
Spare parts kits for integrated relief valve 4 bar	PVT/SST	FKM-A/EPDM	1031199
Spare parts kits for integrated relief valve 7 bar	PVT/SST	FKM-A/EPDM	1031200
Spare parts kits for integrated relief valve 10 bar	PVT	FKM-A/EPDM	1031201
Spare parts kit for relief valve 16 bar	SST	FKM-A/EPDM	1031203

Gear Oil

	Volume	Order no.
Mobilgear 634 VG 460 gear oil	1	1004542

Accessories

- Foot Valves for Motor-Driven Metering Pumps see page → 1-46
- Injection Valves for Motor-Driven Metering Pumps see page → 1-49
- Connectors and Seals for Motor-Driven Metering Pumps see page → 1-75
- Suction Lances, Suction Assemblies and Level Switches for Motor-Driven Metering Pumps see page → 1-64
- Speed Controllers see page → 1-82
- Thermal metering monitor see page

Spare Parts

- Custom Accessories See page → 1-89



1.5 Motor-Driven Metering Pump Sigma/ 2 (Control Type)

1.5.1 Motor-Driven Metering Pump Sigma/ 2 (Control Type)

The intelligent pump for safe and reliable use in many applications.

Capacity range 61 – 353 l/h, 16 – 4 bar

The Sigma/ 2 Control is a robust motor-driven diaphragm metering pump with a patented multi-layer safety diaphragm for outstanding process safety and reliability. The integrated automatic overload shut-down offers further protection for the pump. Removable operating unit and adjustable metering profiles enable the versatile use of this pump.

The Sigma/ 2 Control diaphragm metering pump together with pumps of type Sigma/ 1 Control and Sigma/ 3 Control represent an integrated product range. They cover the capacity range from 17 to 1,040 l/h. The entire Sigma Control product range is equipped with intelligent features to provide a high level of operating convenience, safety and efficiency. The pump product range has a removable operating unit and adjustable metering profiles to ensure optimum metering results.

Your benefits

Excellent process safety and reliability:

- In the event of an accident, the feed chemical does not escape to the outside nor into the pump's power end, thanks to the patented multi-layer safety diaphragm with optical (optionally electric) signalling
- Integrated overload shut-down in the pump control to protect the pump from overloading and thus significantly reduce pressure surges caused by blockages. =NEW Feature=
- Automatic, integrated overload shut-down to protect the pump and bleed option during the metering process to ensure reliable operation

Flexible adaptation to the process:

- Detachable operating unit with large illuminated LC display for outstanding user convenience
- Metering profiles for optimum metering results
- The entire Sigma product range is available as standard in a "Physiologically safe in respect of wetted materials" design and with electro-polished stainless steel dosing head and EHEDG certification for applications with strict hygiene requirements
- Different control options are available, as well as easy connection to bus-networked systems by PROFIBUS®
- Customised designs are available on request

Technical Details

- Stroke length: 5 mm,
- Stroke length adjustment range: 0 – 100 %
- Stroke length adjustment: manually using self-locking rotary dial in 1 % increments
- Metering reproducibility is better than $\pm 2 \%$ in the 30 – 100 % stroke length adjustment range under defined conditions and with correct installation
- Wetted materials: PVDF, stainless steel 1.4571/1.4404, special materials on request
- Patented multi-layer safety diaphragm with optical diaphragm rupture display (optionally with diaphragm rupture warning system via a contact)
- Integrated automatic overload switch-off as a pump protection function
- Integrated hydraulic relief and bleed valve
- Removable operating unit with large illuminated LC display
- Metering profiles for optimum metering results
- Power supply: 1-phase, 100 – 230 V $\pm 10 \%$, 240 V $\pm 6 \%$, 50/60 Hz (220 W)
- Degree of protection IP 65
- Highly rigid fibreglass-reinforced plastic housing with excellent chemical resistance
- For reasons of safety, provide suitable overload protection mechanisms in all mechanically deflected diaphragm metering pumps.

Field of application

- Volume-proportional addition of chemicals in water treatment, e.g. sodium-calcium hypochlorite for the disinfection of potable water
- Neutralisation in waste water treatment
- Time-controlled addition of chemicals in the cooling water circuit
- Pulse-controlled metering in the bottling of different volumes e.g. glycerin filling of manometers

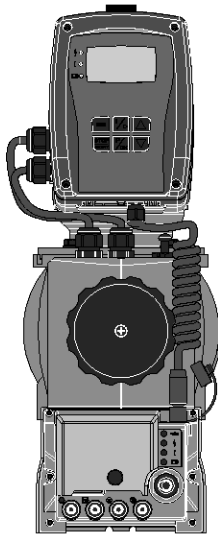

P_SI_0131_SW
Sigma/ 2 control type

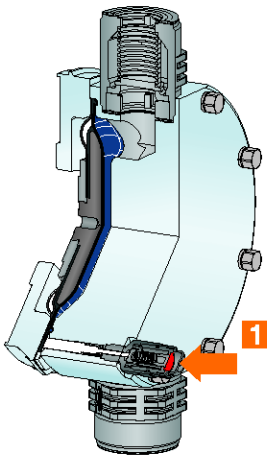

P_SI_0065_C1
1: Diaphragm rupture sensor

1.5 Motor-Driven Metering Pump Sigma/ 2 (Control Type)

Detachable Operating Unit (HMI)

The operating unit (HMI) can be attached directly to the metering pump or mounted on the wall alongside the pump. This provides the operator with a range of options for the integration of a metering system in the overall system that it is readily accessible and easy to use. Moreover the removable operating unit offers additional protection against unauthorised operation of the metering pump or against modification of the pump settings. The operating unit can, for example, be completely removed for project applications.

Individual functions of the metering pump can be easily selected and adjusted with five program keys. An illuminated LCD display provides information about the relevant operating status. LEDs on the operating unit and the control unit indicate the active pump functions or the pump status.

Overload switch-off

The distinguishing feature of the new Sigma product range is its automatic overload shut-down to protect the pump. The motion and speed profiles are detected and evaluated together with the energy demand. This data enables the energy supply to be limited to the amount of energy actually needed. In addition, an analysis of the energy requirement leads to automatic monitoring of the metering pump in the event of an overload situation. This facilitates the internal overload shut-down, offering additional protection for the motor-driven metering pump. The overload shut-down requires standard operation of the metering profile.



P_SI_0099_SW3

Metering Profiles

Metering profiles guarantee optimum metering results by adapting the metering behaviour of the metering pump to the application or chemical used.

The stroke motion of the displacement body is continually recorded and regulated so that the stroke is made in line with the desired metering profile. The pump can be operated in normal mode (Diagram 1), with optimised discharge stroke (Diagram 2) or with optimised suction stroke (Diagram 3). Three typical metering profiles are shown schematically with the behaviour over time.

In normal operating mode (standard), the time behaviour for the suction stroke and the discharge stroke is similar (Diagram 1). In the mode with optimised discharge stroke (Diagram 2), the discharge stroke is lengthened while the suction stroke is made as quickly as possible. This set-up is suited to applications which require optimum mixing and as continuous a mixing of chemicals as possible, for example.

In the mode with the optimised suction stroke (diagram 3), the suction stroke is carried out as slowly as possible, permitting precise and trouble-free metering of viscous and gaseous media. Select this setting to minimise the NPSH value as well.

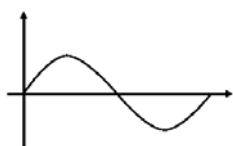

P_SI_0102_SW

Diagram 1: Discharge stroke, suction stroke equal

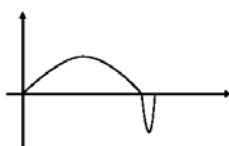

P_SI_0103_SW

Diagram 2: Long discharge stroke, short suction stroke

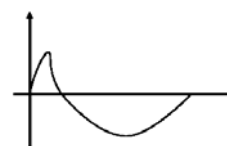

P_SI_0104_SW

Diagram 3: Short discharge stroke, long suction stroke

"Physiologically Safe (FDA) in Respect of Wetted Materials" Version

All wetted materials in the "Physiologically safe (FDA) in respect of wetted materials" "F" design comply with the FDA guidelines (Version F).

FDA guidelines:

- Material PTFE: FDA-No. 21 CFR § 177.1550
- Material PVDF: FDA-No. 21 CFR § 177.2510

Available for material version PV and SS.

Identity code example: S2CbH16050PV F S010UA10S0DE



1.5 Motor-Driven Metering Pump Sigma/ 2 (Control Type)

Technical Data

Type S2Cb	Delivery rate at max. back pressure			Max. stroke rate	Delivery rate at max. back pressure		Suction lift	Perm. pre-pressure suction side	Connection, suction/ discharge side	Shipping weight
	bar	l/h	ml/ stroke		Strokes/ min	psi				
16050 PVT	10	61	11.4	90	145	16.1	7	2	1-15	15
16050 SST	16	56	10.4	90	232	14.8	7	2	1-15	20
16090 PVT	10	109	11.4	160	145	28.8	7	2	1-15	15
16090 SST	16	99	10.3	160	232	26.2	7	2	1-15	20
16130 PVT	10	131	10.9	200	145	34.6	7	2	1-15	15
16130 SST	16	129	10.9	200	232	34.1	7	2	1-15	20
07120 PVT	7	150	27.4	90	102	39.6	5	1	1 1/2-25	16
07120 SST	7	150	27.4	90	102	39.6	5	1	1 1/2-25	24
07220 PVT	7	271	27.7	160	102	71.6	5	1	1 1/2-25	16
07220 SST	7	271	27.7	160	102	71.6	5	1	1 1/2-25	24
04350 PVT	4	353	29.4	200	58	93.3	5	1	1 1/2-25	16
04350 SST	4	353	29.4	200	58	93.3	5	1	1 1/2-25	24

* With Sigma types 07120, 07220 and 04350, the dosing head is fitted with DN 25 (G 1 1/2) valves. As DN 20 is generally sufficient for these types of pipes (see technical data, suction/discharge side connector), the connector parts that can be ordered under the identity code (e.g. inserts) are already reduced to DN 20, i.e. piping and accessories can be installed in DN 20.

Materials in Contact With the Medium

Material	Dosing head	Suction/pressure connector	Seals/ball seat	Balls	Integral relief valve
PVT	PVDF	PVDF	PTFE/PTFE	Ceramic/glass*	PVDF/FKM or EPDM
SST	Stainless steel 1.4404	Stainless steel 1.4581	PTFE/PTFE	Stainless steel 1.4404	Stainless steel/FKM or EPDM

* With 07120, 07220, 04350

With "F" sealing material design – "physiologically safe - FDA", the ball seat is made of PVDF

Motor Data

Identity code specification	Power supply	Remarks
U	1-phase, IP 65 100 – 230 V ±10 % / 240 V ±6 % 50/60 Hz	220 W

Motors less than 0.75 kW and motors designed for speed-controllable operation are not subject to the IE3 standard in compliance with the Ecodesign Directive 2009/125/EC.



1.5 Motor-Driven Metering Pump Sigma/ 2 (Control Type)

Sigma/ 2 Control Type (S2Cb)

S2Cb	Drive type		H Main power end, diaphragm							
	Pump type									
	bar	l/h	bar	l/h	bar	l/h	bar	l/h	bar	l/h
	16050	16* 56	16130	16 129	07220	7 271				
	16090	16* 99	07120	7 150	04350	4 353				
	Dosing head material		PV PVDF (max. 10 bar) SS Stainless steel							
	Seal material		T PTFE seal F FDA-compliant							
	Displacement body		S Multi-layer safety diaphragm with optical rupture indicator A Multi-layer safety diaphragm with electrical signal							
	Dosing head version		0 no valve spring (standard) 1 with 2 valve springs, Hastelloy C; 0.1 bar 2 with bleed valve, FKM seal, no valve spring 3 with bleed valve, FKM seal, with valve spring 4** with relief valve, FPM seal, no valve springs 5** with relief valve, FPM seal, with valve springs 6** with relief valve, EPDM seal, no valve springs 7** with relief valve, EPDM seal, with valve springs 8 with bleed valve, EPDM seal, no valve spring 9 with bleed valve, EPDM seal, with valve spring							
	Hydraulic connector		0 Standard connection 1 Union nut and PVC insert 2 Union nut and PP insert 3 Union nut and PVDF insert 4 Union nut and stainless steel*** insert 7 Union nut and PVDF tube nozzle 8 Union nut and stainless steel tube nozzle 9 Union nut and stainless steel welding sleeve							
	Version		0 With ProMinent® Logo 1 Without ProMinent® Logo							
	Electric power supply		U 1 ph, 100 – 230 V ±10%, 240 V ±6%, 50/60 Hz, 220 W							
	Cable and plug		A 2 m Europe C 2 m Australia B 2 m Swiss D 2 m USA							
	Relay		0 No relay 1 Fault indicating relay (230 V, 8 A) 3 Fault indicating relay (24 V, 100 mA) + pacing relay (24 V, 100 mA) 8 0/4-20 mA analogue output + fault indicating / pacing relay (24 V - 100 mA)							
	Control versions		0 Manual + external contact with pulse control 1 as per 0 + analogue 6 As 1 + PROFIBUS® DP interface, M 12 7 as 1 + CANopen (CiA 402, M12 plug), pump without operating unit (HMI) ****							
	Overload switch-off		0 without overload switch-off 1 with overload shut-down (standard profile only) *****							
	Operating unit (HMI)		S HMI (0.5 m cable) 1 HMI + 2 m cable 2 HMI + 5 m cable 3 HMI + 10 m cable X without operating unit (HMI)							
	Access code		0 without access control 1 with access control							
Language										
DE	German									
EN	English									
ES	Spanish									
FR	French									
IT	Italian									
NL	Dutch									
PL	Polish									
PT	Portuguese									

* 10 bar for PVDF version.

** Standard with tube nozzle in the bypass. Threaded connection on request.

*** Internal thread of the insert SS DN15-Rp 1/2, DN25/20-G 3/4

**** An HMI order no. 1042549 is required for manual operation, e.g. with the failure of the CAN bus

***** Automatic overload shut-down standard without metering profile

Dosing heads with EGEDG certificate in an electro-polished design (<Ra 0.8) or stainless steel dosing heads with seals according to EU regulation 1935/2004 are available on request.



1.5 Motor-Driven Metering Pump Sigma/ 2 (Control Type)

1.5.2 Spare Parts

The spare parts kit generally includes the wear parts for the liquid ends.

Scope of delivery with PVT material version:

- 1 diaphragm
- 2 valves, complete
- 2 valve balls
- 2 ball seats
- 4 composite seals
- 1 elastomer sealing set (EPDM, FKM-B)

Scope of delivery with SST material version:

- 1 diaphragm
- 2 valve balls
- 2 ball seat discs
- 4 composite seals

Spare Parts Kit for Sigma/ 2 for Design With Multi-layer Safety Diaphragm

(Applies to identity code types 16050, 16090, 16130, 12050, 12090 and 12130)

Liquid end	Materials in contact with the medium	Order no.
FM 130 - DN 15	PVT	1035951
FM 130 - DN 15	SST	1035957
FM 130 - DN 15	SST with 2 valves cpl.	1035954

(Applies to identity code types 07120, 07220 and 04350)

Liquid end	Materials in contact with the medium	Order no.
FM 350 - DN 25	PVT	1035953
FM 350 - DN 25	SST	1035960
FM 350 - DN 25	SST with 2 valves cpl.	1035959

Spare Parts Kits for Sigma/ 2 for Design With Old Diaphragm

(Applies to identity code types 16050, 16090, 16130, 12050, 12090 and 12130)

Liquid end	Materials in contact with the medium	Order no.
FM 130 - DN 15	PVT	740324
FM 130 - DN 15	SST	740326
FM 130 - DN 15	SST with 2 valves cpl.	740328

(Applies to identity code types 07120, 07220 and 04350)

Liquid end	Materials in contact with the medium	Order no.
FM 350 - DN 25	PVT	740325
FM 350 - DN 25	SST	740327
FM 350 - DN 25	SST with 2 valves cpl.	740329



1.5 Motor-Driven Metering Pump Sigma/ 2 (Control Type)

Spare Parts Kits for Sigma/ 2 With FDA Design (Physiologically Safe)

(Applies to identity code types 16050, 16090, 16130, 12050, 12090 and 12130)

Liquid end	Materials in contact with the medium	Order no.
FM 130 - DN 15	PVT	1046472
FM 130 - DN 15	SST without valve	1046473
FM 130 - DN 15	SST with valve	1046474

(Applies to identity code types 07120, 07220 and 04350)

Liquid end	Materials in contact with the medium	Order no.
FM 350 - DN 25	PVT	1046475
FM 350 - DN 25	SST without valve	1046476
FM 350 - DN 25	SST with valve	1046477

Multi-layer Safety Diaphragm (Standard)

Order no.
FM 130 (type: 16050, 16090, 16130)
1029771
FM 350 (type: 07120, 07220, 04350)
1033422

Metering Diaphragm (Old Version)

Order no.
Sigma with FM 130 identity code: Type 16050, 16090, 16130
792495
Sigma with FM 350 identity code: Type 07120, 07220, 04350
792496

Spare Parts Kit for Integrated Relief Valve (S2Ca, S2Cb)

Consisting of two compression springs made from Hastelloy C and four FKM-A and EPDM O-rings each

	For material	Seals	Order no.
Spare parts kits for integrated relief valve 4 bar	PVT/SST	FKM-A/EPDM	1031199
Spare parts kits for integrated relief valve 7 bar	PVT/SST	FKM-A/EPDM	1031200
Spare parts kits for integrated relief valve 10 bar	PVT	FKM-A/EPDM	1031201
Spare parts kit for relief valve 16 bar	SST	FKM-A/EPDM	1031203

Gear Oil

	Volume	Order no.
Mobilgear 634 VG 460 gear oil	1	1004542

Spare Parts Kits for Integrated Bleed Valve (S2Cb)

Consisting of a compression spring made from Hastelloy C and four FKM-A and EPDM O-rings each
 For identity code specification "Dosing head version" with characteristic "2", "3", "8", "9"

	For material	Seals	Order no.
ETS	PVT/SST	FKM-A/EPDM	1043785



1.5 Motor-Driven Metering Pump Sigma/ 2 (Control Type)

Protective Cowling for Operating Unit (HMI)

Protection of the operating unit (HMI) of Sigma metering pumps against contamination; made from transparent silicone plastic. For Sigma control types S1Cb / S2Cb / S3Cb.

	Order no.
Protective cowling for operating unit (S1Cb, S2Cb, S3Cb)	1036724

Wall Bracket for Operating Unit (HMI)

Wall bracket with operating lever for wall mounting of the operating unit (HMI) without any fittings. For Sigma control types S1Cb / S2Cb / S3Cb.

	Order no.
Wall bracket for operating unit (S1Cb, S2Cb, S3Cb)	1036683

Extension cable for operating unit (HMI)

	Order no.
Connecting cable - CAN M12 5-pole 1 m	1022139
Connecting cable - CAN M12 5-pole 2 m	1022140
Connecting cable - CAN M12 5-pole 5 m	1022141
Connecting cable - CAN M12 5-pin. 10 m*	1046383

Accessories of CANopen operation

An operating unit is needed for the manual operation of a CANopen pump.

	Order no.
Operating unit (HMI)	1042549

Accessories

- Foot Valves see page → 1-46
- Injection Valves see page → 1-49
- Connector Parts, Seals, Hoses see page → 1-75
- Suction Lances/Suction Assemblies see page → 1-64

Spare Parts

- Custom Accessories See page → 1-89



1.6 Motor-Driven Metering Pump Sigma/ 3 (Basic Type)

1.6.1

Motor-Driven Metering Pump Sigma/ 3 (Basic Type)

The robust pump for safe and reliable use

Capacity range 146 – 1,030 l/h, 12 – 4 bar



The patented multi-layer safety diaphragm for excellent process safety and reliability is just one feature of the extremely robust motor-driven diaphragm metering pump Sigma/ 3 Basic. It also offers a wide range of power end versions, such as three-phase or 1-phase AC motors, even for Exe and Exde areas with ATEX certification.

The Sigma/ 3 diaphragm metering pump together with pumps of type Sigma/ 1 and Sigma/ 2 represent an integrated product range. They cover the capacity range from 17 to 1,030 l/h, with a consistent operating concept, control concept and spare parts management. A wide range of drive versions is available, including some for use in Exe and Exde areas with ATEX certification.

Your benefits

Excellent process safety and reliability:

- In the event of an accident, the feed chemical does not escape to the outside nor into the pump's power end, thanks to the patented multi-layer safety diaphragm with optical (optionally electric) signalling
- Integrated relief valve protects the pump against overloading
- Reliable operation by bleed option during the suction process

Flexible adaptation to the process:

- The entire Sigma product range is available as standard in a "Physiologically safe in respect of wetted materials" design.
- Metering pumps with electro-polished stainless steel metering head and EHEDG certification enable them to be used in hygienically challenging applications
- Wide range of power end versions, also for use in Exe and Exde areas and different flange designs for the use of customised motors
- Customised designs are available on request

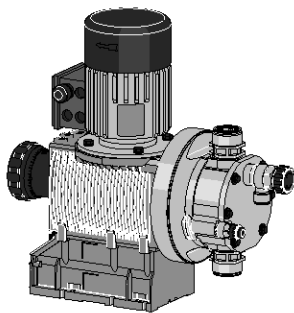

P_SL_0132_SW
Sigma/ 3

Technical Details

- Stroke length: 6 mm,
- Stroke length adjustment range: 0 – 100%
- Stroke length adjustment: manually by self-locking rotary dial in 1% increments (optionally with actuator or control drive)
- Metering reproducibility is better than $\pm 2\%$ with a 30-100% stroke length adjustment range under certain defined conditions and with proper installation.
- Wetted materials: PVDF, stainless steel 1.4571/1.4404, special materials on request
- Patented multi-layer safety diaphragm with optical diaphragm rupture display (optionally with diaphragm rupture warning system via a contact)
- Integrated hydraulic relief and bleed valve
- A wide range of power end versions is available: Three-phase standard motor, 1-phase AC motor, motors for use in Exe and Exde areas and different flange designs for use in customer-specific motors
- Degree of protection IP 55 (optionally II2GEEExIIIT3, II2GEEExIIICT4)
- Highly rigid fibreglass-reinforced plastic housing with excellent chemical resistance
- For reasons of safety, provide suitable overload protection mechanisms in all mechanically deflected diaphragm metering pumps.

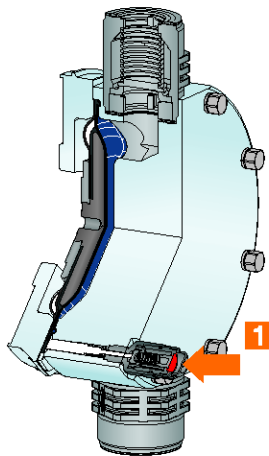

P_SL_0065_C1
1: Diaphragm rupture sensor

Field of application

- Volume-proportional addition of chemicals in water treatment, e.g. sodium-calcium hypochlorite for the disinfection of potable water
- Addition of chemicals depending on the measured value, e.g. metering of acid and alkali for pH neutralisation in waste water treatment
- Time-controlled addition of chemicals in the cooling water circuit
- Pulse-controlled metering in the bottling of different volumes e.g. glycerin filling of manometers



1.6 Motor-Driven Metering Pump Sigma/ 3 (Basic Type)

Sigma Basic Type Control Functions (S3Ba)

Stroke length actuator/controller

Actuator with stroke positioning motor for automatic stroke length adjustment. Setting time approx. 1 sec for 1 % stroke length. Resistance potentiometer 1 kΩ. Enclosure rating IP 54.

Controller consisting of actuator with stroke positioning motor and in-built follower for stroke length adjustment via a standard signal. Standard signal current input 0/4-20 mA corresponds to stroke length 0 - 100%. Can be switched between manual and automatic operation, key switch for stroke adjustment for manual operation. Mechanical status display of actual stroke length value output 0/4-20 mA for remote display.

Speed controllers in metal housing (identity code characteristic Z)

The speed controller assembly consists of a speed controller and a 0.55 kW variable speed motor.

"Physiologically safe (FDA) in respect of wetted materials" design "F"

All wetted materials in the "Physiologically safe (FDA) in respect of wetted materials" design comply with the FDA guidelines (Version F).

FDA guidelines:

- Material PTFE: FDA-No. 21 CFR § 177.1550
- Material PVDF: FDA-No. 21 CFR § 177.2510

Available for material version PV and SS and DN 25 ball valve.

Identity code example: S3BaH120330PV F S000S000



1.6 Motor-Driven Metering Pump Sigma/ 3 (Basic Type)

Technical Data

Type S3Ba	With 1500 rpm motor at 50 Hz				With 1800 rpm motor at 60 Hz			Perm. pre- pressure suction side bar	Suc- tion lift m WC	Connection, suction/dis- charge side G-DN	Shipping weight kg
	Delivery rate at max. back pressure		Max. stroke rate Strokes/ min	Delivery rate at max. back pressure		Max. stroke rate Strokes/ min					
	l/h	ml/ stroke		psi	l/h/gph (US)						
120145 PVT	10	146	33.7	72	145	174/45.9	86	2	5	1 1/2-25	22
120145 SST	12	146	33.7	72	174	174/45.9	86	2	5	1 1/2-25	26
120190 PVT	10	208	33.7	103	145	251/66.3	124	2	5	1 1/2-25	22
120190 SST	12	208	33.7	103	174	251/66.3	124	2	5	1 1/2-25	26
120270 PVT	10	292	33.8	144	145	351/92.7	173	2	5	1 1/2-25	22
120270 SST	12	292	33.8	144	174	351/92.7	173	2	5	1 1/2-25	26
120330 PVT*	10	365	33.8	180	-	-	-	2	5	1 1/2-25	22
120330 SST*	12	365	33.8	180	-	-	-	2	5	1 1/2-25	26
070410 PVT	7	410	95.1	72	102	492/129.9	86	1	4	2-32-**	24
070410 SST	7	410	95.1	72	102	492/129.9	86	1	4	2-32-**	29
070580 PVT	7	580	95.1	103	102	696/183.8	124	1	4	2-32-**	24
070580 SST	7	580	95.1	103	102	696/183.8	124	1	4	2-32-**	29
040830 PVT	4	830	95.1	144	58	1,000/264.1	173	1	3	2-32-**	24
040830 SST	4	830	95.1	144	58	1,000/264.1	173	1	3	2-32-**	29
041030 PVT*	4	1,030	95.1	180	-	-	-	1	3	2-32-**	24
041030 SST*	4	1,030	95.1	180	-	-	-	1	3	2-32-**	29

Performance data for TTT, see type PVT

* only available for 50 Hz, ** DN32 plate valves with valve spring

Materials in Contact With the Medium

Material	Seals	DN 25 ball valves			DN 32 plate valves			Integral relief valve
		Suction/pressure connector on dosing head	Valve balls	Valve seats	Suction/pressure connector on dosing head	Valve plates/valve springs	Valve seats	
PVT	PTFE	PVDF	Glass	PTFE**	PVDF	Ceramic/ Hast C. + CTFE*	PTFE	PVDF/FKM or EPDM
SST	PTFE	Stainless steel 1.4581	Stainless steel 1.4404	PTFE**	Stainless steel 1.4581	Stainless steel 1.4404/ Hast. C	PTFE	Stainless steel/ FKM or EPDM
TTT***	PTFE	PTFE + 25% carbon	Ceramic	PTFE**	PVDF	Ceramic/ Hast C. + CTFE*	PTFE	-

* The valve spring is coated with CTFE (resistance similar to PTFE)

** On design "F", the ball seat is made of PVDF, only for DN 25 ball valves

*** Specifically for areas at risk from explosion DN25: PTFE + 25% carbon; DN32 plate valves: PVDF

Motor Data

Identity code specification	Power supply	Δ/Y	Remarks
S	3-phase, IP 55	220 – 240 V/380 – 420 V 250 – 280 V/440 – 480 V	50 Hz 0.37 kW 60 Hz 0.37 kW
T	3-phase, IP 55	220 – 240 V/380 – 420 V 250 – 280 V/440 – 480 V	50 Hz 0.37 kW with PTC, speed control range 1:5 60 Hz
R	3-phase, IP 55	220 – 240 V/380 – 420 V	50 Hz 0.55 kW with PTC, speed adjustment range 1:20 with external fan 1-phase 230 V; 50/60 Hz
M	1-phase AC, IP 55	230 V ± 5 %	50/60 Hz 0.55 kW
N	1-phase AC, IP 55	115 V ± 5 %	60 Hz 0.55 kW
L1	3-phase, II2GEEExIICT3	220 – 240 V/380 – 420 V	50 Hz 0.37 kW
L2	3-phase, II2GEEExIICT4	220 – 240 V/380 – 420 V	50 Hz 0.37 kW with PTC, speed control range 1:5
P1	3-phase, II2GEEExIICT3	250 – 280 V/440 – 480 V	60 Hz 0.37 kW
P2	3-phase, II2GEEExIICT4	250 – 280 V/440 – 480 V	60 Hz 0.37 kW with PTC, speed control range 1:5
V2	3-phase, II2GEEExIICT4	400 V ± 10 %	50/60 Hz 0.55 kW Ex-variable speed motor with integrated frequency converter. Mains feed: 3-phase + neutral + earth, adjustment range 1:10

Motor data sheets can be requested for more information. Motors for Sigma basic pumps, special motors or special motor flanges are available on request. Motors less than 0.75 kW and motors designed for speed-controllable operation are not subject to the IE3 standard in compliance with the Ecodesign Directive 2009/125/EC.

Information for use in areas at risk from explosion

Only use pumps with the appropriate labelling in line with the ATEX Directive 94/9/EC in premises at risk from explosion. Ensure that the explosion group, category and degree of protection specified on the label corresponds to or is better than the conditions prevalent in the intended field of application.



1.6 Motor-Driven Metering Pump Sigma/ 3 (Basic Type)

Sigma/ 3 Basic Type (S3Ba)

S3Ba	Drive type					
	H	Main drive, diaphragm				
	Pump type					
		bar	l/h		bar	l/h
	120145	12	146	070410	7	410
	120190	12	208	070580	7	580
	120270	12	292	040830	4	830
	120330	12	365	041030	4	1,030
	Liquid end material					
	PV	PVDF (max. 10 bar)				
	SS	Stainless steel				
	TT	PTFE + 25% carbon (max. 10 bar)				
	Seals material					
	T	PTFE seal				
	F	FDA-compliant (only with 12 bar version)				
	Diaphragm					
	S	Multi-layer safety diaphragm with optical rupture indicator				
	A	Multi-layer safety diaphragm with rupture signalling (contact)				
	Liquid end version					
	0	No valve springs				
	1	With 2 valve springs, Hastelloy C 4; 0.1 bar (standard for DN 32)				
	4**	With pressure relief valve, FKM seal, no valve springs, only with PV and SS				
	5**	With pressure relief valve, FKM seal with valve springs (standard at DN 32), only with PV and SS				
	6**	With pressure relief valve, EPDM seal, without valve spring, only with PV and SS				
	7**	With pressure relief valve, EPDM seal, with valve springs (standard at DN 32), only with PV and SS				
	Hydraulic connection					
	0	Standard threaded connector (as technical data)				
	1	Union nut and PVC insert				
	2	Union nut and PP insert				
	3	Union nut and PVDF insert				
	4	Union nut and SS insert***				
	7	Union nut and PVDF hose nozzle				
	8	Union nut and SS hose nozzle				
	9	Union nut and stainless steel hose nozzle				
	Version					
	0	With ProMinent® logo				
	1	Without ProMinent® logo				
	M	Modified				
	Electrical power supply					
	S	3 ph, 230 V/400 V				
	T	3 ph, 230 V/400 V, with PTC				
	R	Variable speed motor 3 ph, 230/400 V, with PTC, with external fan 1 ph 230 V 50/60 Hz				
	Z	Speed control compl 1 ph 230 V//400 V (variable speed motor + FC)				
	M	1 ph, 230 V				
	N	1 ph, 115 V				
	L	3 ph, 230 V/400 V, 0.37 kW, 50 Hz, (Exe, Exd)				
	P	3 ph, 265 V/440 V, 0.37 kW, 60 Hz, (Exe, Exd)				
	V (2)	Variable speed motor with integr. FC Exd (delivery with frame)				
	1	No motor, with B5 flange, size 80 (DIN)				
	2	No motor, with C56 NEMA flange				
	3	No motor, with B5 flange, size 71 (DIN)				
	Enclosure rating					
	0	IP 55				
	1	Exe motor version ATEX-T3				
	2	Exd motor version ATEX-T4				
	Stroke sensor					
	0	No stroke sensor (standard)				
	2	Pacing relay (read relay)				
	3	Stroke sensor (Namur) for explosion-proof application				
	Stroke length adjustment					
	0	Manual (standard)				
	1	with servomotor, 85...265 V AC 50/60 Hz				
	3	with stroke control motor 0...20 mA 85...265 V AC 50/60 Hz				
	4	with stroke control motor 4...20 mA 85...265 V AC 50/60 Hz				

* 10 bar for the PVDF and TTT version

** Standard with threaded connector in the bypass. Hose nozzle on request

*** Internal thread of the insert SS DN25-Rp 1, DN32-Rp 1 1/4

Dosing heads with EGEDG certificate in an electro-polished design (<Ra 0.8) or stainless steel dosing heads with seals according to EU regulation 1935/2004 are available on request.

We are happy to supply alternative material versions to comply with export conditions for pump capacities > 600 l/h and PVDF.

1.6 Motor-Driven Metering Pump Sigma/ 3 (Basic Type)

1.6.2 Spare Parts

The spare parts kit generally includes the wear parts for the liquid ends.

Scope of delivery with PVT/ TTT material version:

- 1 diaphragm
- 2 complete valves
- 2 valve balls and/or valve plate with spring for DN 32
- 1 elastomer sealing set (EPDM, FKM-B)
- 2 ball seat housings
- 2 ball seat discs
- 4 composite seals

Scope of delivery with SST material version:

- 1 diaphragm
- 2 valve balls and/or valve plate with spring for DN 32
- 2 ball seat discs
- 4 composite seals

Spare Parts Kits Sigma/ 3 for Design With Multi-layer Safety Diaphragm

(For Identity code: type 120145, 120190, 120270, 120330)

Liquid end	Materials in contact with the medium	Order no.
FM 330 - DN 25	PVT	1034678
FM 330 - DN 25	TTT with 2 valves cpl.	1077575
FM 330 - DN 25	SST	1034679
FM 330 - DN 25	SST with 2 valves cpl.	1034680

(For Identity code: type 070410, 070580, 040830, 041030)

Liquid end	Materials in contact with the medium	Order no.
FM 1000 - DN 32	PVT/PPT/PCT	1034681
FM 1000 - DN 32	SST	1034682
FM 1000 - DN 32	SST with 2 valves cpl.	1034683

Spare Parts Kits for Sigma/ 3 for Design With Old Diaphragm

(Applies to identity code: Type 120145, 120190, 120270, 120330)

Liquid end	Materials in contact with the medium	Order no.
FM 330 - DN 25	PVT	1005308
FM 330 - DN 25	SST	1005310
FM 330 - DN 25	SST with 2 valves cpl.	1005312

(Applies to identity code: Type 070410, 070580, 040830, 041030)

Liquid end	Materials in contact with the medium	Order no.
FM 1000 - DN 32	PVT/PPT/PCT	1020032
FM 1000 - DN 32	SST	1005311
FM 1000 - DN 32	SST with 2 valves cpl.	1005313

Spare Parts Kit for Sigma/ 3 With FDA Design (Physiologically Safe)

(For Identity code: type 120145, 120190, 120270, 120330)

Liquid end	Materials in contact with the medium	Order no.
FM 330 - DN 25	PVT	1046478
FM 330 - DN 25	SST without valve	1046479
FM 330 - DN 25	SST with valve	1046480



1.6 Motor-Driven Metering Pump Sigma/ 3 (Basic Type)

Multi-layer Safety Diaphragm (Standard)

	Order no.
FM 330 identity code: type 120145, 120190, 120270, 120330	1029604
FM 1000 identity code: type 070410, 070580, 040830, 041030	1029603

Metering Diaphragm (Old Version)

	Order no.
FM 330 Identity code: Type 120145, 120190, 120270, 120330	1004604
FM 1000 Identity code: Type 070410, 070580, 040830, 041030	1002835

Spare Parts Kits for Integrated Relief Valve

Consisting of two compression springs made from Hastelloy C and four FKM-A O-rings each

	For material	Seals	Order no.
Spare parts kit for relief valve 4 bar	PVT/SST	FKM-A/EPDM	1031204
Spare parts kit for relief valve 7 bar	PVT/SST	FKM-A/EPDM	1031205
Spare parts kits for integrated relief valve 10 bar	PVT	FKM-A/EPDM	1031201
Spare parts kits for integrated relief valve 12 bar	SST	FKM-A/EPDM	1031202

Gear Oil

	Volume l	Order no.
Mobilgear 634 VG 460 gear oil	1	1004542

Accessories

- Foot Valves for Motor-Driven Metering Pumps see page → 1-46
- Injection Valves for Motor-Driven Metering Pumps see page → 1-49
- Connectors and Seals for Motor-Driven Metering Pumps see page → 1-75
- Suction Lances, Suction Assemblies and Level Switches for Motor-Driven Metering Pumps see page → 1-64
- Speed Controllers see page → 1-82
- Thermal metering monitor see page

Spare Parts

- Custom Accessories See page → 1-89



1.7 Motor-Driven Metering Pump Sigma/ 3 (Control Type)

1.7.1

Motor-Driven Metering Pump Sigma/ 3 (Control Type)

The intelligent pump for safe and reliable use in many applications

Capacity range 182 – 1,040 l/h, 12 – 4 bar



The motor-driven diaphragm metering pump Sigma/ 3 Control guarantees excellent process reliability, thanks to its patented multi-layer safety diaphragm. Intelligent features, such as removable operating unit and adjustable metering profiles, as well as a variety of power end and control configurations, enable the versatile use of this pump.

The Sigma/ 3 Control diaphragm metering pump together with pumps of type Sigma/ 1 Control and Sigma/ 2 Control represent an integrated product range. They cover the capacity range from 17 to 1,040 l/h. The entire Sigma Control product range is equipped with intelligent features to provide a high level of operating convenience, safety and efficiency. The pump product range has a removable operating unit and adjustable metering profiles to ensure optimum metering results.

Your benefits

Excellent process safety and reliability:

- In the event of an accident, the feed chemical does not escape to the outside nor into the pump's power end, thanks to the patented multi-layer safety diaphragm with optical (optionally electric) signalling
- Integrated relief valve protects the pump against overloading and reliable operation by bleed option during the discharge process

Flexible adaptation to the process:

- Detachable operating unit with large illuminated LC display for outstanding user convenience
- Metering profiles for optimum metering results
- The entire Sigma product range is available as standard in a "Physiologically safe in respect of wetted materials" design and with electro-polished stainless steel dosing head and EHEDG certification for applications with strict hygiene requirements
- Different control options are available, as well as easy connection to bus-networked systems by integrated PROFIBUS® module. Connection of PROFINET applications using the ProMinent DULCOnter PROFIBUS®-PROFINET converter
- Customised designs are available on request

Technical Details

- Stroke length: 6 mm
- Stroke length adjustment range: 0 – 100%
- Stroke length adjustment: manually by self-locking rotary dial in 1% increments
- Metering reproducibility is better than $\pm 2\%$ in the 30 – 100% stroke length adjustment range under defined conditions and with correct installation
- Wetted materials: PVDF, stainless steel 1.4571/1.4404, special materials on request
- Patented multi-layer safety diaphragm with optical diaphragm rupture display (optionally with diaphragm rupture warning system via a contact)
- Integrated hydraulic relief and bleed valve
- Removable operating unit with large illuminated LC display
- Metering profiles for optimum metering results
- Degree of protection IP 65
- Highly rigid fibreglass-reinforced plastic housing with excellent chemical resistance
- For reasons of safety, provide suitable overload protection mechanisms in all mechanically deflected diaphragm metering pumps.

Field of application

- Volume-proportional addition of chemicals in water treatment, e.g. sodium-calcium hypochlorite for the disinfection of potable water
- Neutralisation in waste water treatment
- Time-controlled addition of chemicals in the cooling water circuit
- Pulse-controlled metering in the bottling of different volumes e.g. glycerin filling of manometers

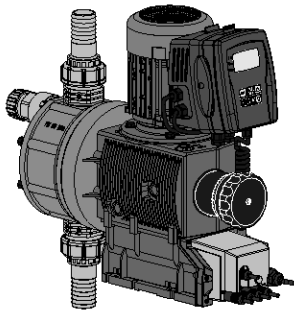

P_SL_0101_SW
Sigma/ 3 control type

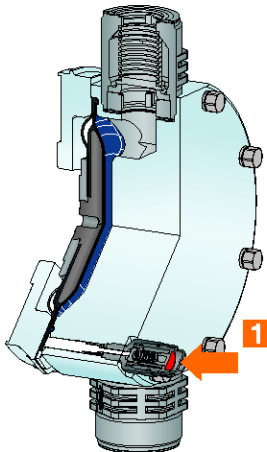

P_SL_0065_C1
1: Diaphragm rupture sensor



1.7 Motor-Driven Metering Pump Sigma/ 3 (Control Type)



P_SI_0099_SW3

Detachable Operating Unit (HMI)

The operating unit (HMI) can be attached directly to the metering pump or mounted on the wall alongside the pump. This provides the operator with a range of options for the integration of a metering system in the overall system that it is readily accessible and easy to use. Moreover the removable operating unit offers additional protection against unauthorised operation of the metering pump or against modification of the pump settings. The operating unit can, for example, be completely removed for project applications.

Individual functions of the metering pump can be easily selected and adjusted with five program keys. An illuminated LCD display provides information about the relevant operating status. LEDs on the operating unit and the control unit indicate the active pump functions or the pump status.

Metering Profiles

Metering profiles guarantee optimum metering results by adapting the metering behaviour of the metering pump to the application or chemical used.

The stroke motion of the displacement body is continually recorded and regulated so that the stroke is made in line with the desired metering profile. The pump can be operated in normal mode (Diagram 1), with optimised discharge stroke (Diagram 2) or with optimised suction stroke (Diagram 3). Three typical metering profiles are shown schematically with the behaviour over time.

In normal operating mode (standard), the time behaviour for the suction stroke and the discharge stroke is similar (Diagram 1). In the mode with optimised discharge stroke (Diagram 2), the discharge stroke is lengthened while the suction stroke is made as quickly as possible. This set-up is suited to applications which require optimum mixing and as continuous a mixing of chemicals as possible, for example.

In the mode with the optimised suction stroke (diagram 3), the suction stroke is carried out as slowly as possible, permitting precise and trouble-free metering of viscous and gaseous media. Select this setting to minimise the NPSH value as well.

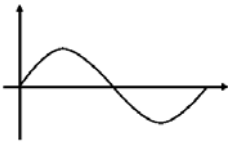

P_SI_0102_SW

Diagram 1: Discharge stroke, suction stroke equal

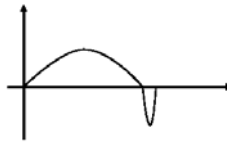

P_SI_0103_SW

Diagram 2: Long discharge stroke, short suction stroke

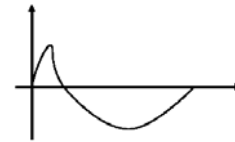

P_SI_0104_SW

Diagram 3: Short discharge stroke, long suction stroke

"Physiologically Safe (FDA) in Respect of Wetted Materials" Version

All wetted materials in the "Physiologically safe (FDA) in respect of wetted materials" design comply with the FDA guidelines (Version F).

FDA guidelines:

- Material PTFE: FDA No. 21 CFR § 177.1550
- Material PVDF: FDA No. 21 CFR § 177.2510

Available for material version PV and SS.

Identity code example: S1CbH07042PV F S010S0DE .



1.7 Motor-Driven Metering Pump Sigma/ 3 (Control Type)

Technical Data

Type S3Cb	Delivery rate at max. back pressure			Max. stroke rate	Delivery rate at max. back pressure		Suction lift	Perm. pre-pressure suction side	Connection, suction/discharge side	Shipping weight
	bar	l/h	ml/stroke		Strokes/min	psi				
120145 PVT	10	182	33.7	90	145	48.0	5	2	1 1/2-25	22
120145 SST	12	182	33.7	90	174	48.0	5	2	1 1/2-25	26
120190 PVT	10	243	33.7	120	145	64.1	5	2	1 1/2-25	22
120190 SST	12	243	33.7	120	174	64.1	5	2	1 1/2-25	26
120270 PVT	10	365	33.8	180	145	96.4	5	2	1 1/2-25	22
120270 SST	12	365	33.8	180	174	96.4	5	2	1 1/2-25	26
070410 PVT	7	500	95.1	90	102	132.0	4	1	2-32-*	24
070410 SST	7	500	95.1	90	102	132.0	4	1	2-32-*	29
070580 PVT	7	670	95.1	120	102	176.9	4	1	2-32-*	24
070580 SST	7	670	95.1	120	102	176.9	4	1	2-32-*	29
040830 PVT	4	1,040	95.1	180	58	274.7	3	1	2-32-*	24
040830 SST	4	1,040	95.1	180	58	274.7	3	1	2-32-*	29

* DN32 plate valves with valve spring

Materials in Contact With the Medium

Material	Suction/pressure connector on dosing head	DN 25 ball valves			DN 32 plate valves			Integral relief valve
		Seals	Valve balls	Valve seats	Seals	Valve plates/ valve springs	Valve seats	
PVT	PVDF	PTFE	Glass	PTFE**	PTFE	Ceramic/ Hast C. + CTFE*	PTFE	PVDF/FKM or EPDM
SST	Stainless steel 1.4581	PTFE	Stainless steel 1.4404	PTFE**	PTFE	Stainless steel 1.4404/ Hast. C	PTFE	Stainless steel/FKM or EPDM

* The valve spring is coated with CTFE (resistance similar to PTFE)

** The ball seat is made of PVDF with design "F"

Motor Data

Identity code specification	Power supply				Remarks
U	1-phase, IP 65	100 – 230 V ±10 % / 240 V ±6 %		50/60 Hz	420 W

Motors less than 0.75 kW and motors designed for speed-controllable operation are not subject to the IE3 standard in compliance with the Ecodesign Directive 2009/125/EC.



1.7 Motor-Driven Metering Pump Sigma/ 3 (Control Type)

Sigma/ 3 Control type (S3Cb)

S3Cb Drive type		H Main power end, diaphragm			
Pump type					
	bar	l/h	bar	l/h	
120145	12	182	070410	7	500
120190	12	243	070580	7	670
120270	12	365	040830	4	1,040
Dosing head material		PV PVDF (max. 10 bar) SS Stainless steel			
Seal material		T PTFE seal F FDA-compliant (only with 12 bar version)			
Displacement body		S Multi-layer safety diaphragm with optical rupture indicator A Multi-layer safety diaphragm with electrical signal			
Dosing head version		0 no valve spring (standard) 1 with 2 valve springs, Hastelloy C; 0.1 bar (standard for DN 32) 2 with bleed valve, FKM seal, no valve spring 3 with bleed valve, FKM seal, with valve spring 4** with relief valve, FPM seal, no valve springs 5** with relief valve, FPM seal, with valve springs 6** with relief valve, EPDM seal, no valve springs 7** with relief valve, EPDM seal, with valve springs 8 with bleed valve, EPDM seal, no valve spring 9 with bleed valve, EPDM seal, with valve spring			
Hydraulic connector		0 Standard connection 1 Union nut and PVC insert 2 Union nut and PP insert 3 Union nut and PVDF insert 4 Union nut and stainless steel*** insert 7 Union nut and PVDF tube nozzle 8 Union nut and stainless steel tube nozzle 9 Union nut and stainless steel welding sleeve			
Version		0 With ProMinent® Logo 1 Without ProMinent® Logo			
Electric power supply		U 1 ph, 100 – 230 V ±10%, 240 V ±6%, 50/60 Hz, 420 W			
Cable and plug		A 2 m Europe C 2 m Australia B 2 m Swiss D 2 m USA			
Relay		0 No relay 1 Fault indicating relay (230 V, 8 A) 3 Fault indicating relay (24 V, 100 mA) + pacing relay (24 V, 100 mA) 8 0/4-20 mA analogue output + fault indicating / pacing relay (24 V - 100 mA)			
Control versions		0 Manual + external contact with pulse control 1 As 0 + analogue + metering profiles 6 As 1 + PROFIBUS® DP interface, M 12 7 as 1 + CANopen (CiA 402, M12 plug), pump without operating unit (HMI) ****			
Overload switch-off		0 without overload switch-off			
Operating unit (HMI)		S HMI (0.5 m cable) 1 HMI + 2 m cable 2 HMI + 5 m cable 3 HMI + 10 m cable X without operating unit (HMI)			
Access code		0 without access control 1 with access control			
Language		DE German EN English ES Spanish FR French IT Italian NL Dutch PL Polish PT Portuguese			

* 10 bar with PVDF version.

** Standard with threaded connector in the bypass. Hose nozzle on request

*** Internal thread of the insert SS DN25-Rp 1, DN32-Rp 1 1/4

**** An HMI order no. 1042549 is required for manual operation, e.g. with the failure of the CAN bus

Dosing heads with EGEDG certificate in an electro-polished design (<Ra 0.8) or stainless steel dosing heads with seals according to EU regulation 1935/2004 are available on request.

We are happy to supply alternative material versions to comply with export conditions for pump capacities > 600 l/h and PVDF.

1



1.7 Motor-Driven Metering Pump Sigma/ 3 (Control Type)

1.7.2 Spare Parts

The spare parts kit generally includes the wear parts for the liquid ends.

Scope of delivery with PVT/ TTT material version:

- 1 diaphragm
- 2 complete valves
- 2 valve balls and/or valve plate with spring for DN 32
- 1 elastomer sealing set (EPDM, FKM-B)
- 2 ball seat housings
- 2 ball seat discs
- 4 composite seals

Scope of delivery with SST material version:

- 1 diaphragm
- 2 valve balls and/or valve plate with spring for DN 32
- 2 ball seat discs
- 4 composite seals

Spare Parts Kits Sigma/ 3 for Design With Multi-layer Safety Diaphragm

(For Identity code: type 120145, 120190, 120270, 120330)

Liquid end	Materials in contact with the medium	Order no.
FM 330 - DN 25	PVT	1034678
FM 330 - DN 25	SST	1034679
FM 330 - DN 25	SST with 2 valves cpl.	1034680

(For Identity code: type 070410, 070580, 040830, 041030)

Liquid end	Materials in contact with the medium	Order no.
FM 1000 - DN 32	PVT/PPT/PCT	1034681
FM 1000 - DN 32	SST	1034682
FM 1000 - DN 32	SST with 2 valves cpl.	1034683

Spare Parts Kits for Sigma/ 3 for Design With Old Diaphragm

(Applies to identity code: Type 120145, 120190, 120270, 120330)

Liquid end	Materials in contact with the medium	Order no.
FM 330 - DN 25	PVT	1005308
FM 330 - DN 25	SST	1005310
FM 330 - DN 25	SST with 2 valves cpl.	1005312

(Applies to identity code: Type 070410, 070580, 040830, 041030)

Liquid end	Materials in contact with the medium	Order no.
FM 1000 - DN 32	PVT/PPT/PCT	1020032
FM 1000 - DN 32	SST	1005311
FM 1000 - DN 32	SST with 2 valves cpl.	1005313

Spare Parts Kit for Sigma/ 3 With FDA Design (Physiologically Safe)

(For Identity code: type 120145, 120190, 120270, 120330)

Liquid end	Materials in contact with the medium	Order no.
FM 330 - DN 25	PVT	1046478
FM 330 - DN 25	SST without valve	1046479
FM 330 - DN 25	SST with valve	1046480



1.7 Motor-Driven Metering Pump Sigma/ 3 (Control Type)

Multi-layer Safety Diaphragm (Standard)

	Order no.
FM 330 identity code: type 120145, 120190, 120270, 120330	1029604
FM 1000 identity code: type 070410, 070580, 040830, 041030	1029603

Metering Diaphragm (Old Version)

	Order no.
FM 330 Identity code: Type 120145, 120190, 120270, 120330	1004604
FM 1000 Identity code: Type 070410, 070580, 040830, 041030	1002835

Spare Parts Kit for Integrated Relief Valve (S3Ca, S3Cb)

Consisting of two compression springs made from Hastelloy C and four FKM-A O-rings each

	For material	Seals	Order no.
Spare parts kit for relief valve 4 bar	PVT/SST	FKM-A/EPDM	1031204
Spare parts kit for relief valve 7 bar	PVT/SST	FKM-A/EPDM	1031205
Spare parts kits for integrated relief valve 10 bar	PVT	FKM-A/EPDM	1031201
Spare parts kits for integrated relief valve 12 bar	SST	FKM-A/EPDM	1031202

Gear Oil

	Volume l	Order no.
Mobilgear 634 VG 460 gear oil	1	1004542

Spare Parts Kits for Integrated Bleed Valve (S3Cb)

Consisting of a compression spring made from Hastelloy C and four FKM-A and EPDM O-rings each

For identity code specification "Dosing head version" with characteristic "2", "3", "8", "9"

	Pump type	For material	Seals	Order no.
ETS	120145, 120190, 120270	PVT/SST	FKM-A/EPDM	1043785
ETS	070410, 070580, 040830	PVT/SST	FKM-A/EPDM	1043786

Protective Cowling for Operating Unit (HMI)

Protection of the operating unit (HMI) of Sigma metering pumps against contamination; made from transparent silicone plastic. For Sigma control types S1Cb / S2Cb / S3Cb.

	Order no.
Protective cowling for operating unit (S1Cb, S2Cb, S3Cb)	1036724

Wall Bracket for Operating Unit (HMI)

Wall bracket with operating lever for wall mounting of the operating unit (HMI) without any fittings. For Sigma control types S1Cb / S2Cb / S3Cb.

	Order no.
Wall bracket for operating unit (S1Cb, S2Cb, S3Cb)	1036683



1.7 Motor-Driven Metering Pump Sigma/ 3 (Control Type)

Extension cable for operating unit (HMI)

	Order no.
Connecting cable - CAN M12 5-pole 1 m	1022139
Connecting cable - CAN M12 5-pole 2 m	1022140
Connecting cable - CAN M12 5-pole 5 m	1022141
Connecting cable - CAN M12 5-pin. 10 m*	1046383

Accessories of CANopen operation

An operating unit is needed for the manual operation of a CANopen pump.

	Order no.
Operating unit (HMI)	1042549

Accessories

- Foot Valves See page → 1-46
- Injection Valves See page → 1-49
- Connector Parts, Seals, Hoses See page → 1-75
- Suction Lances/Suction Assemblies See page → 1-64

Spare Parts

- Custom Accessories See page → 1-89



1.8 Hydraulic/Mechanical Accessories

1.8.1 Foot Valves for Motor-Driven Metering Pumps

For connection to the end of the suction line, used as a vacuum breaker and for protection of the pump against contamination. With filter meshes and ball check. Materials used as in the pump liquid ends. Union nuts and inserts/tube nozzles are included in the scope of supply with DN 10 and DN 15 foot valve sizes.

Important: Foot valves are not suitable as absolutely leak-tight shut-off devices.

PPE Foot Valve

Housing made of PP, seals made of EPDM, with filter meshes and ball check (glass).

DN 10, DN 15 with union nut and PP tube nozzle

DN 20 to DN 40 no connection parts

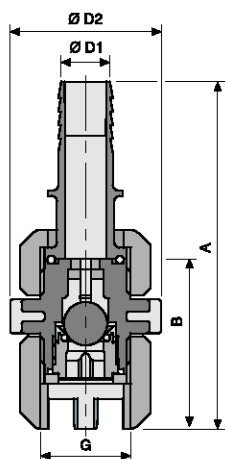

P_AC_0206_SW

	G	B	Ø D2	A	Ø D1	Order no.
		mm	mm	mm	mm	
DN 10	3/4	59	40	101	16	809465
DN 15	1	66	47	142	20	924516
DN 20	1 1/4	77	55	-	-	803721
DN 25	1 1/2	84	60	-	-	803722
DN 32*	2	98	74	-	-	1006434
DN 40	2 1/4	113	90	-	-	1004204

* PVDF/Teflon version

PCB Foot Valve

Housing made of PP, seals made of FKM, with filter meshes and ball check (glass).

DN 10, DN 15 with union nut and PP tube nozzle

DN 20 to DN 40 no connection parts

	G	B	Ø D2	A	Ø D1	Order no.
		mm	mm	mm	mm	
DN 10	3/4	59	40	101	16	809464
DN 15	1	66	47	142	20	924515
DN 20	1 1/4	77	55	-	-	803723
DN 25	1 1/2	84	60	-	-	803724
DN 32*	2	98	74	-	-	1006434
DN 40*	2 1/4	108	83	-	-	1029475

* PVDF/Teflon version

PVT Foot Valve

Housing made of PVDF, ball seat made of PTFE + 25% carbon, PTFE seals, with filter meshes and non-return valve (ceramic).

DN 10, DN 15 with union nut and PP tube nozzle

DN 20 to DN 40 no connection parts

	G	B	Ø D2	A	Ø D1	Order no.
		mm	mm	mm	mm	
DN 10	3/4	58	36	92	16	1029471
DN 15	1	64	48	131	20	1029472
DN 20	1 1/4	78	58	-	-	1029473
DN 25	1 1/2	81	65	-	-	1029474
DN 32	2	98	74	-	-	1006434
DN 40	2 1/4	108	83	-	-	1029475



1.8 Hydraulic/Mechanical Accessories

Foot valve PVT-FDA

"Physiologically safe (FDA) in respect of wetted materials" design.

All wetted materials in the "Physiologically safe (FDA) in respect of wetted materials" design comply with the FDA guidelines.

- Material PTFE: FDA No. 21 CFR § 177.1550
- Material PVDF: FDA No. 21 CFR § 177.2510

Housing made of PVDF, seals made of PTFE, with filter meshes and check ball (ceramic).

DN 10, DN 15 with union nut and hose nozzle
 DN 20, DN 25 no connection parts

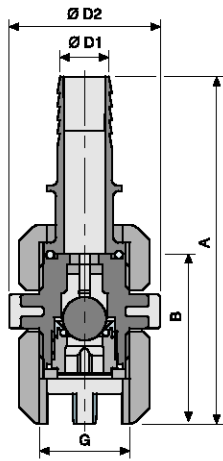

P_AC_0206_SW

	G	B mm	Ø D2 mm	A mm	Ø D1 mm	Order no.
DN 10	3/4	58	36	92	16	1078269
DN 15	1	64	48	131	20	1078270
DN 20	1 1/4	78	58	-	-	1078271
DN 25	1 1/2	81	65	-	-	1078272

Foot Valve TTT

Housing made of PTFE, seals made of PTFE, with filter meshes and ball check (ceramic).

DN 10, DN 15 with union nut and insert
 DN 20 to DN 40 no connection parts

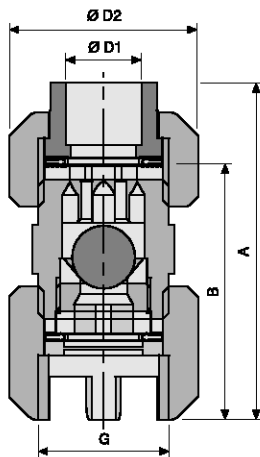

P_AC_0202_SW

	G	B mm	Ø D2 mm	A mm	Ø D1 mm	Order no.
DN 10	3/4	59	40	101	16	809466
DN 15	1	66	47	142	20	924517
DN 20	1 1/4	81	57	-	-	803725
DN 25	1 1/2	86	64	-	-	803726
DN 32*	2	98	74	-	-	1006434
DN 40	2 1/4	116	89	-	-	1004205

* PVDF/Teflon version

Foot Valve SST

Housing made of SS, PTFE + 25% ball seat, PTFE seals, with filter meshes and ball check (1.4571/1.4581).

DN 10, DN 15 with union nut and insert
 DN 20 to DN 40 no connection parts

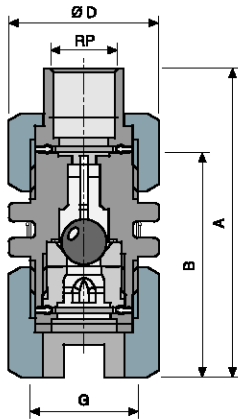

P_AC_0204_SW

	G	A mm	B mm	Rp	Ø D mm	Order no.
DN 10	3/4	75	56	3/8	37	809467
DN 15	1	83	59	1/2	48	924518
DN 20	1 1/4	-	73	-	55	803727
DN 25	1 1/2	-	82	-	63	803728
DN 32	2	-	92	-	75	1006435
DN 40	2 1/4	-	109	-	90	1004206



1.8 Hydraulic/Mechanical Accessories

1

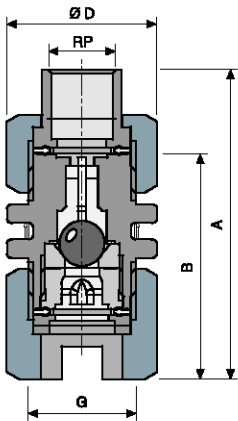

P_AC_0204_SW

Foot valve SST-FDA

"Physiologically safe (FDA) in respect of wetted materials" design

All wetted materials in the "Physiologically safe (FDA) in respect of wetted materials" design comply with the FDA guidelines.

FDA guidelines:

- Material PTFE: FDA No. 21 CFR § 177.1550
- Material PVDF: FDA No. 21 CFR § 177.2510

Housing made of SS, PVDF ball seat, PTFE seals, with filter meshes and non-return valve (1/4571/1.4581).

DN 10, DN 15 with union nut and insert

DN 20 to DN 40 no connection parts

	G	A mm	B mm	Rp	Ø D mm	Order no.
DN 10	3/4	75	56	3/8	37	1078275
DN 15	1	83	59	1/2	48	1078289
DN 20	1 1/4	-	73	-	55	1078290
DN 25	1 1/2	-	82	-	63	1078291

Foot Valve SST for High-Pressure Metering Pumps

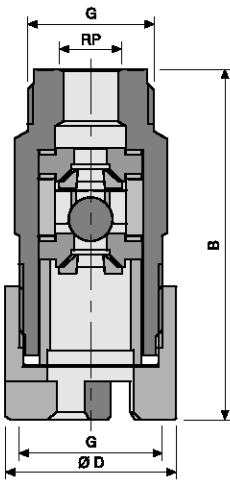

P_AC_0205_SW

	G	B mm	Rp	Ø D mm	Order no.
DN 10	3/4	70	1/4	41	803730
DN 10	3/4	70	3/8	41	803731



1.8 Hydraulic/Mechanical Accessories

1.8.2 Injection Valves for Motor-Driven Metering Pumps

For connecting the metering line to the metering station; metering valves consist of a non-return ball valve and a Hastelloy C spring (0.5 bar pre-pressure) and can be installed in any position. Used for generating pressure and preventing backflow. Materials match those in the pump liquid ends. Metering valve sizes DN 10 and 15 come with the required union nut and insert/hose socket.

Important: Metering valves are not suitable for use as tight-sealing shut-off elements.

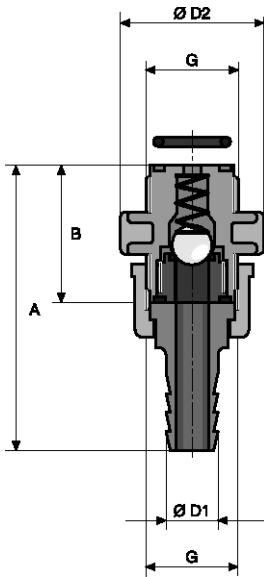

pk_2_029

PPE Injection Valve

PP housing, EPDM seals with spring-loaded ball check (glass), priming pressure approx. 0.5 bar.

DN 10, DN 15 with union nut and PP tube nozzle
 DN 20 to DN 40 no connection parts

Operating range

25 °C - max. operating pressure 16 bar
 50 °C - max. operating pressure 9 bar

	G	B	Ø D2	A	Ø D1	Order no.
		mm	mm	mm	mm	
DN 10	3/4	41	40	83	16	809461
DN 15	1	43	47	108	20	924521
DN 20	1 1/4	55	55	–	–	803710
DN 25	1 1/2	60	58	–	–	803711
DN 32*	2	68	70	–	–	1002783
DN 40	2 1/4	85	84	–	–	804761

* PVDF/Teflon version

PCB Injection Valve

PVC housing, FKM seals with spring-loaded ball check (glass), priming pressure approx. 0.5 bar.

DN 10, DN 15 with union nut and PP tube nozzle
 DN 20 to DN 40 no connection parts

Operating range

25 °C - max. operating pressure 16 bar
 45 °C - max. operating pressure 7 bar

	G	B	Ø D2	A	Ø D1	Order no.
		mm	mm	mm	mm	
DN 10	3/4	41	40	83	16	809460
DN 15	1	43	47	108	20	924520
DN 20	1 1/4	55	55	–	–	803712
DN 25	1 1/2	60	58	–	–	803713
DN 32*	2	68	70	–	–	1002783
DN 40	2 1/4	85	84	–	–	804760

* PVDF/Teflon version



1.8 Hydraulic/Mechanical Accessories

1

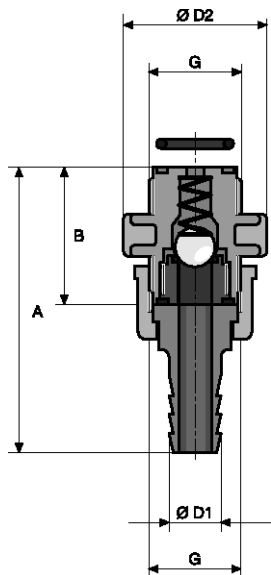

pk_2_029

Injection valve PVT

PVDF housing, PTFE + 25% carbon ball seat, PTFE seals, with spring-loaded non-return sphere (ceramic), priming pressure approx. 0.5 bar.

DN 10, DN 15 with union nut and PP tube nozzle

DN 20 to DN 40 no connection parts

Operating range

25 °C - max. operating pressure 16 bar

65 °C - max. operating pressure 10 bar

	G	B mm	Ø D2 mm	A mm	Ø D1 mm	Order no.
DN 10	3/4	40	36	84	16	1029476
DN 15	1	43	48	110	20	1029477
DN 20	1 1/4	55	52	-	-	1029478
DN 25	1 1/2	61	56	-	-	1029479
DN 32	2	68	70	-	-	1002783
DN 40	2 1/4	85	81	-	-	1029480

Injection valve PVT-FDA

"Physiologically safe (FDA) in respect of wetted materials" design.

All wetted materials in the "Physiologically safe (FDA) in respect of wetted materials" design comply with the FDA guidelines.

FDA guidelines:

- Material PTFE: FDA No. 21 CFR § 177.1550
- Material PVDF: FDA No. 21 CFR § 177.2510

PVDF housing, PTFE seals, with spring-loaded non-return sphere (ceramic), priming pressure approx. 0.5 bar.

DN 10, DN 15 with union nut and PP tube nozzle

DN 20 to DN 40 no connection parts

Operating range

25 °C - max. operating pressure 16 bar

65 °C - max. operating pressure 10 bar

	G	B mm	Ø D2 mm	A mm	Ø D1 mm	Order no.
DN 10	3/4	40	36	84	16	1078237
DN 15	1	43	48	110	20	1078238
DN 20	1 1/4	55	52	-	-	1078239
DN 25	1 1/2	61	56	-	-	1078240



1.8 Hydraulic/Mechanical Accessories

TTT Injection Valve

PTFE housing and seals with spring-loaded ball check (ceramic), priming pressure approx. 0.5 bar.

DN 10, DN 15 with union nut and insert
 DN 20 to DN 40 no connection parts

Operating range

25 °C - max. operating pressure 10 bar
 90 °C - max. operating pressure 5 bar

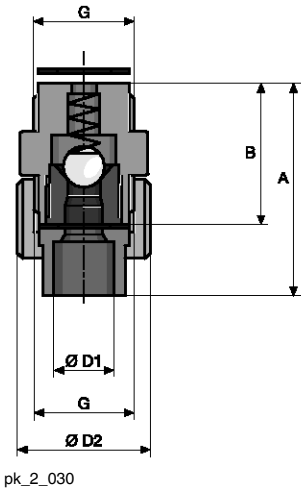

	G	B mm	Ø D2 mm	A mm	Ø D1 mm	Order no.
DN 10	3/4	38	36	57	16	809462
DN 15	1	43	48	63	20	924522
DN 20	1 1/4	55	50	–	–	803714
DN 25	1 1/2	60	58	–	–	803715
DN 32*	2	68	70	–	–	1002783
DN 40	2 1/4	85	84	–	–	804762

* PVDF/Teflon version

SST Injection Valve

Housing made of stainless steel, PTFE + 25% carbon ball seat, PTFE seals non-return sphere (stainless steel material no. 1.4571 / stainless steel no. 1.4581) spring-loaded, priming pressure approx. 0.5 bar.

DN 10, DN 15 with union nut and insert
 DN 20 to DN 40 no connection parts

Applications

90 °C - max. operating pressure, see table

	G	Max. pressure bar	B mm	Ø D2 mm	A mm	Ø D1	Order no.
DN 10	3/4	320	38	36	55	3/8	809463
DN 15	1	240	43	48	63	1/2	924523
DN 20	1 1/4	130	55	55	–	–	803716
DN 25	1 1/2	70	60	58	–	–	803717
DN 32	2	45	69	68	–	–	1002801
DN 40	2 1/4	25	85	84	–	–	804763

Injection valve HCT

Hastelloy C housing, Hastelloy C ball seat, PTFE seals, with spring-loaded non-return balls (ceramic), priming pressure approx. 0.5 bar.

DN 10, DN 15 with union nut and insert

Applications

90 °C - max. operating pressure, see table

	G	Max. pressure bar	B mm	Ø D2 mm	A mm	Ø D1	Order no.
DN 10	3/4	100	38	37	59	3/8	1009569
DN 15	1	100	43	48	66	1/2	1009570



1.8 Hydraulic/Mechanical Accessories

1

Injection valve SST - FDA

"Physiologically safe (FDA) in respect of wetted materials" design.

All wetted materials in the "Physiologically safe (FDA) in respect of wetted materials" design comply with the FDA guidelines.

FDA guidelines:

- Material PTFE: FDA No. 21 CFR § 177.1550
- Material PVDF: FDA No. 21 CFR § 177.2510

Housing made of stainless steel, PVDF ball seat, PTFE seals with non-return sphere (stainless steel material no. 1.4571 / stainless steel no. 1.4581) spring-loaded, priming pressure approx. 0.5 bar.

DN 10, DN 15 with union nut and insert
 DN 20 to DN 40 no connection parts

Applications

90 °C - max. operating pressure, see table

	G	Max. pressure bar	B mm	Ø D2 mm	A mm	Ø D1	Order no.
DN 10	3/4	320	38	36	55	3/8	1078251
DN 15	1	240	43	48	63	1/2	1078252
DN 20	1 1/4	130	55	55	-	-	1078266
DN 25	1 1/2	70	60	58	-	-	1078267

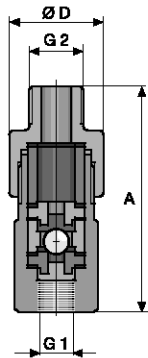

pk_2_028

Injection valve SST for high-pressure metering pumps

To fit metering pumps of the product ranges Sigma, Meta and Makro TZ-HK.

Housing and valve spring made of stainless steel no. 1.4571, ball made of stainless steel no. 1.4401, PTFE seals, priming pressure approx. 0.1 bar.

Applications

90 °C - max. operating pressure, see table

	Max. pressure bar	G1	G2	Ø D mm	A mm	Order no.
DN 8	320	Rp 1/4	Rp 1/2	42	85	803732
DN 10	190	Rp 3/8	Rp 1/2	42	90	803733

PVDF Metering Valve Adapter

For the installation of injection valves into pipework with straight unions.

The adapter projects into the pipework or storage tanks and can be adjusted (shortened) at different cross-sections.

Direct contact of the chemical to be metered with the wall can be avoided by installation of the adapter. Metering into the centre of the pipework improves, among other things, the mixing through of the metering solution.

Material: PVDF

Applications

25 °C - max. operating pressure 16 bar
 65 °C - max. operating pressure 10 bar

E1	E2	A mm	B mm	C m	D mm	Ø D1 mm	Ø D2 mm	Order no.
Rp 3/4	R 3/4	93	63	49	32	22	15	1022052
Rp 1	R 1	95	65	50	41	27	18	1022053
G 1 1/4	G 1 1/4 A*	150	119	104	50	27	18	1040722
G 1 1/2	G 1 1/2 A*	171	135	118	60	31	20	1040723

D = Width across flats

* In set with 1 x FKM and 1 x EPDM O-ring.

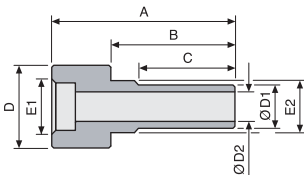

P_AC_0275_SW



1.8 Hydraulic/Mechanical Accessories

1.8.3 Back Pressure Valves / Relief Valves for Motor-Driven Metering Pumps

Universal back pressure valves of the DHV-U product range are back pressure-free piston diaphragm valves with an internal flow. They are used to generate a constant back pressure and as relief valves. Can be installed at any location in the pipework system.

Back pressure valves are used to generate a constant back pressure for precise pumping and to protect against over-metering where there is a free outlet or fluctuating back pressure or when metering into a vacuum. They are also used in conjunction with pulsation dampers to generate low-pulsation metering.

Relief valves are used to protect pumps, pipes and fittings from over pressure, in the event of incorrect operation or blockages in the bypass. In the event of a malfunction, the pump pumps around the circuit or back into the storage tank.

Important: Back pressure valves cannot be used as absolutely leak-tight shut-off devices. Take appropriate safety precautions when handling hazardous media. Relief valves are not safety valves by their definition as per DIN EN ISO 4126-1.

Important: When used as relief valves in conjunction with sticky media (e.g. lime milk), appropriate safety precautions should be taken. (e.g. flushing after a response)

Back Pressure Valve / Relief Valve Type DHV-U

Adjustable pressure 0.5 – 10 bar

Application of PPE/PPB/PCE/PCB:

20 °C - max. operating pressure 10 bar

Application of PVT/SST:

30 °C - max. operating pressure 10 bar

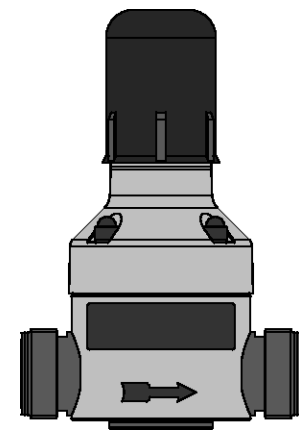

P_AC_0256_SW

Type	Nominal diameter	G	Order no.
PPE	DN 10	3/4	1037285
PPB	DN 10	3/4	1038133
PCE	DN 10	3/4	1038144
PCB	DN 10	3/4	1037765
PVT	DN 10	3/4	1037767
SST	DN 10	3/4	1043194
PPE	DN 15	1	1036816
PPB	DN 15	1	1038145
PCE	DN 15	1	1038146
PCB	DN 15	1	1037764
PVT	DN 15	1	1037766
SST	DN 15	1	1043193
PPE	DN 20	1 1/4	1037284
PPB	DN 20	1 1/4	1038147
PCE	DN 20	1 1/4	1038148
PCB	DN 20	1 1/4	1037775
PVT	DN 20	1 1/4	1037777
SST	DN 20	1 1/4	1043192
PPE	DN 25	1 1/2	1036633
PPB	DN 25	1 1/2	1038149
PCE	DN 25	1 1/2	1038150
PCB	DN 25	1 1/2	1037774
PVT	DN 25	1 1/2	1037776
SST	DN 25	1 1/2	1043191
PPE	DN 32	2	1051517
PPB	DN 32	2	1051522
PCE	DN 32	2	1051514
PCB	DN 32	2	1051520
PVT	DN 32	2	1051503
SST	DN 32	2	1051516



1.8 Hydraulic/Mechanical Accessories

1

Type	Nominal diameter	G	Order no.
PPE	DN 40	2 1/4	1051518
PPB	DN 40	2 1/4	1051521
PCE	DN 40	2 1/4	1051501
PCB	DN 40	2 1/4	1051519
PVT	DN 40	2 1/4	1051502
SST	DN 40	2 1/4	1051515

Materials

Type	Housing/Connectors	Plungers	Plunger Seal	Seal/Connectors
PPE	PP	PVDF	EPDM	EPDM
PPB	PP	PVDF	FKM	FKM
PCE	PVC	PVDF	EPDM	EPDM
PCB	PVC	PVDF	FKM	FKM
PVT	PVDF	PVDF	PTFE*	FKM
SST	1.4404	1.4404	PTFE*	PTFE

* Cover ring made of PTFE/FKM

Dimensions of DHV-U (PP, PVC, PVDF design)

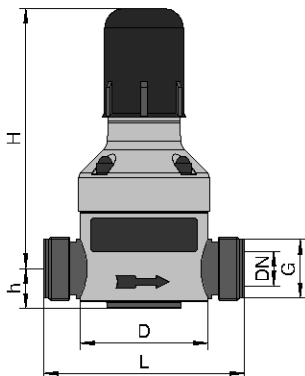

P_AC_0256_m

DN	G	H mm	L mm	h mm	D mm	m	B mm
10	3/4	144*	118	24	79	M6	40
15	1	144*	118	24	79	M8	40
20	1 1/4	196*	150	37	99	M8	46
25	1 1/2	196*	150	37	99	M6	46
32	2	252	200	54	139.5	M8	65
40	2 1/4	252	200	54	139.5	M8	65

* Approximate values

Dimensions of DHV-U (SS version)

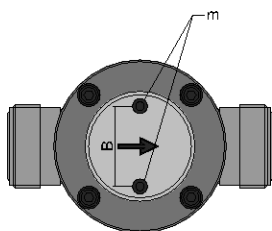

P_MOZ_0005_SW

DN	G	H mm	L mm	h mm	D mm	m	B mm
10	3/4	144*	118	20	79	M6	40
15	1	144*	118	20	79	M6	40
20	1 1/4	196*	150	30	99	M6	46
25	1 1/2	196*	150	30	99	M6	46
32	2	252	200	37	139.5	M8	65
40	2 1/4	252	200	37	139.5	M8	65

* Approximate values



1.8 Hydraulic/Mechanical Accessories

Back pressure valve/ relief valve type DHV-U design FDA

Adjustable pressure 0.5 – 10 bar

Application of PPE/PPB/PCE/PCB

20 °C - max. operating pressure 10 bar

Application of PVT/SST

30 °C - max. operating pressure 10 bar

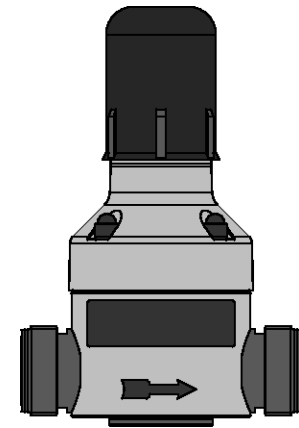

P_AC_0256_SW

Type	Nominal diameter	G	Order no.
PPE	DN 10	3/4	1076578
PVT	DN 10	3/4	1076579
SST	DN 10	3/4	1076532
PPE	DN 15	1	1076580
PVT	DN 15	1	1076581
SST	DN 15	1	1076531
PPE	DN 20	1 1/4	1076582
PVT	DN 20	1 1/4	1076583
SST	DN 20	1 1/4	1076597
PPE	DN 25	1 1/2	1076585
PVT	DN 25	1 1/2	1076586
SST	DN 25	1 1/2	1076584
PPE	DN 32	2	1076587
PVT	DN 32	2	1076588
SST	DN 32	2	1076589
PPE	DN 40	2 1/4	1076590
PVT	DN 40	2 1/4	1076591
SST	DN 40	2 1/4	1076592

All wetted materials in the "Physiologically safe (FDA) in respect of wetted materials" design comply with the following FDA guidelines:

Material	Guideline
PTFE	21CFR177.1510
PVDF	21CFR177.2510
PP	21CFR177.1520
EPDM/FKM	21CFR177.2600

Materials

Type	Housing/Connectors	Plungers	Plunger Seal	Seal/Connectors
PPE	PP	PVDF	EPDM	EPDM
PVT	PVDF	PVDF	PTFE*	FKM
SST	1.4404	1.4404	PTFE*	PTFE

* Cover ring made of PTFE/FKM



1.8 Hydraulic/Mechanical Accessories

1

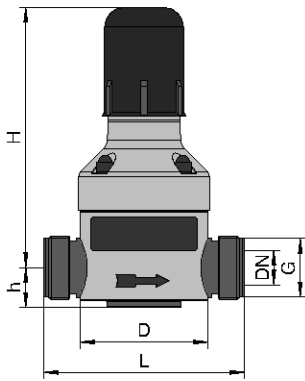

P_AC_0256_m

Dimensions of DHV-U (FDA) (PP, PVC, PVDF design)

DN	G	H mm	L mm	h mm	D mm	m	B mm
10	3/4	144*	118	24	79	M6	40
15	1	144*	118	24	79	M6	40
20	1 1/4	196*	150	37	99	M6	46
25	1 1/2	196*	150	37	99	M6	46
32	2	252*	200	54	139.5	M8	65
40	2 1/4	252*	200	54	139.5	M8	65

* Approximate values

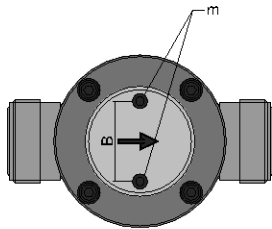

P_MOZ_0005_SW

Dimensions of DHV-U (FDA) (SS design)

DN	G	H mm	L mm	h mm	D mm	m	B mm
10	3/4	144*	118	20	79	M6	40
15	1	144*	118	20	79	M6	40
20	1 1/4	196*	150	30	99	M6	46
25	1 1/2	196*	150	30	99	M6	46
32	2	252*	200	37	139.5	M8	65
40	2 1/4	252*	200	37	139.5	M8	65

* Approximate values



1.8 Hydraulic/Mechanical Accessories

Relief valve type DHV-UR

The universal relief valves type DHV-UR are, like all valves in the DHV-U product range, are continuously adjustable plunger diaphragm valves with an internal flow. In the event of impermissible overpressure, the internal plunger diaphragm opens the second output power, the bleeder output. Can be installed at any location in the pipework system. Very low pressure losses when the relief valve is closed owing to its virtually free pipe cross-section. Simple spare parts management, the wear parts (pressure spring, diaphragms, plunger seal, connector set seal) correspond to the DHV-U valve product range.

Adjustable pressure 0.5 – 10 bar

Application of PPE/PPB/PCE/PCB

20 °C - max. operating pressure 10 bar

Application of PVT/SST

30 °C - max. operating pressure 10 bar

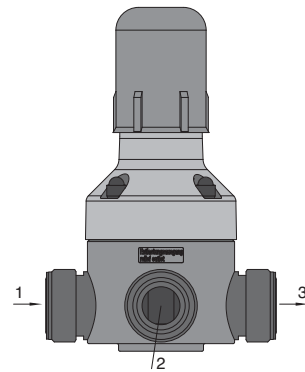

P_AC_0267

- 1 Input
- 2 Bleeder output
- 3 Output

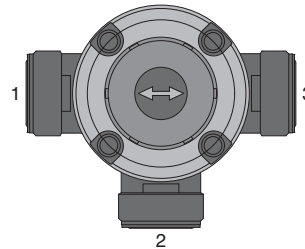

P_AC_0268

- 1 Input
- 2 Bleeder output
- 3 Output

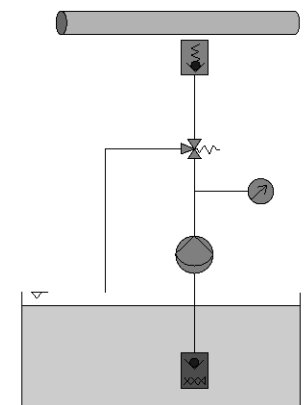

AP_0003

Type	Nominal diameter	G	Order no.
PPE	DN 10	3/4	1061337
PPB	DN 10	3/4	1061341
PCE	DN 10	3/4	1061339
PCB	DN 10	3/4	1061343
PVT	DN 10	3/4	1061365
SST	DN 10	3/4	1061550
PPE	DN 15	1	1061336
PPB	DN 15	1	1061340
PCE	DN 15	1	1061338
PCB	DN 15	1	1061342
PVT	DN 15	1	1061364
SST	DN 15	1	1061551
PPE	DN 20	1 1/4	1061367
PPB	DN 20	1 1/4	1061371
PCE	DN 20	1 1/4	1061369
PCB	DN 20	1 1/4	1061373
PVT	DN 20	1 1/4	1061375
SST	DN 20	1 1/4	1061569
PPE	DN 25	1 1/2	1061366
PPB	DN 25	1 1/2	1061370
PCE	DN 25	1 1/2	1061368
PCB	DN 25	1 1/2	1061372
PVT	DN 25	1 1/2	1061374
SST	DN 25	1 1/2	1061570

Materials used

Type	Housing/Connectors	Plungers	Plunger Seal	Seal/Connectors
PPE	PP	PVDF	EPDM	EPDM
PPB	PP	PVDF	FKM	FKM
PCE	PVC	PVDF	EPDM	EPDM
PCB	PVC	PVDF	FKM	FKM
PVT	PVDF	PVDF	PTFE*	FKM
SST	1.4404	1.4404	PTFE*	PTFE

* Cover ring made of PTFE/FKM



1.8 Hydraulic/Mechanical Accessories

1

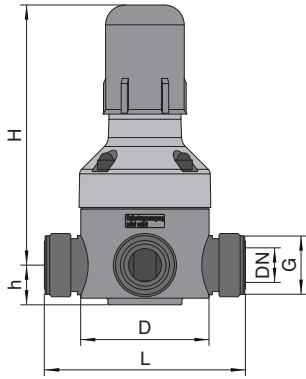

P_AC_0267_V2

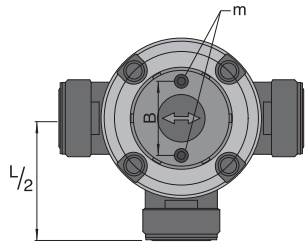

P_AC_0268_V2

Dimensions of DHV-UR (PP, PVC, PVDF design)

DN	G	H mm	L mm	h mm	D mm	m	B mm
10	3/4	144*	118	24	79	M6	35
15	1	144*	118	24	79	M6	35
20	1 1/4	196*	150	37	99	M6	46
25	1 1/2	196*	150	37	99	M6	46

* Approximate values

Dimensions of DHV-UR (SS design)

DN	G	H mm	L mm	h mm	D mm	m	B mm
10	3/4	144*	118	20	79	M6	35
15	1	144*	118	20	79	M6	35
20	1 1/4	196*	150	30	99	M6	46
25	1 1/2	196*	150	30	99	M6	46

* Approximate values



1.8 Hydraulic/Mechanical Accessories

Relief valve type DHV-UR, FDA design

Adjustable pressure 0.5 – 10 bar

Application of PPE/PPB/PCE/PCB

20 °C - max. operating pressure 10 bar

Application of PVT/SST

30 °C - max. operating pressure 10 bar

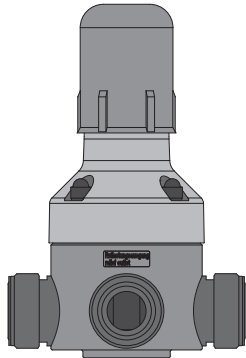

P_AC_0267

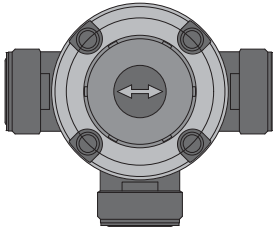

P_AC_0268_V3

Type	Nominal diameter	G	Order no.
PPE	DN 10	3/4	1075828
PVT	DN 10	3/4	1075830
SST	DN 10	3/4	1075847
PPE	DN 15	1	1075827
PVT	DN 15	1	1075829
SST	DN 15	1	1075846
PPE	DN 20	1 1/4	1075833
PVT	DN 20	1 1/4	1075845
SST	DN 20	1 1/4	1075849
PPE	DN 25	1 1/2	1075832
PVT	DN 25	1 1/2	1075844
SST	DN 25	1 1/2	1075848

All wetted materials in the "Physiologically safe (FDA) in respect of wetted materials" design comply with the following FDA guidelines:

Material	Guideline
PTFE	21CFR177.1510
PVDF	21CFR177.2510
PP	21CFR177.1520
EPDM/FKM	21CFR177.2600

Materials used

Type	Housing/Connectors	Plungers	Plunger Seal	Seal/Connectors
PPE	PP	PVDF	EPDM	EPDM
PVT	PVDF	PVDF	PTFE*	FKM
SST	1.4404	1.4404	PTFE*	PTFE

* Cover ring made of PTFE/FKM

Dimensions of DHV-UR (FDA) (PP, PVC, PVDF design)

DN	G	H mm	L mm	h mm	D mm	m	B mm
10	3/4	144*	118	24	79	M6	35
15	1	144*	118	24	79	M6	35
20	1 1/4	196*	150	37	99	M6	46
25	1 1/2	196*	150	37	99	M6	46

* Approximate values

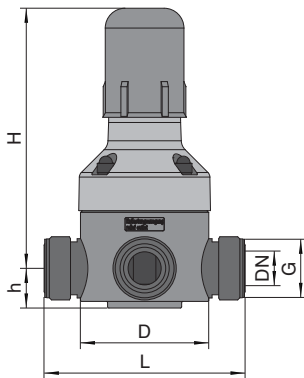

P_AC_0267_V2

Dimensions of DHV-UR (FDA) (SS design)

DN	G	H mm	L mm	h mm	D mm	m	B mm
10	3/4	144*	118	20	79	M6	35
15	1	144*	118	20	79	M6	35
20	1 1/4	196*	150	30	99	M6	46
25	1 1/2	196*	150	30	99	M6	46

* Approximate values

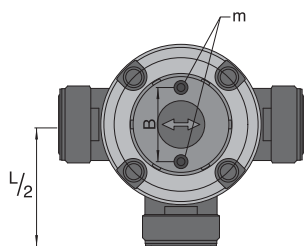

P_AC_0268_V2



1.8 Hydraulic/Mechanical Accessories

1

Relief valve type DHV-UR M configured for manometer

The relief valves DHV-UR with M designs are configured with a plug for manometer installation. Manometer with threaded socket G 1/4" (ISO 228) can be fitted by the customer directly to the relief valve via the additional housing opening. Standard manometers with part number are available for neutral media. This also enables savings in terms of installation.

Adjustable pressure 0.5 – 10 bar

Application of PPE/PPB/PCE/PCB:

20 °C - max. operating pressure 10 bar

Application of PVT/SST:

30 °C - max. operating pressure 10 bar

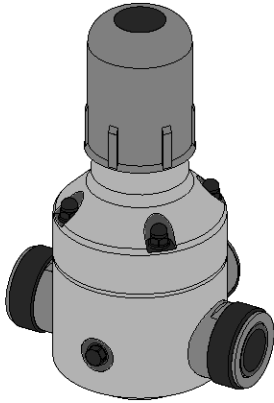

P_AC_0272

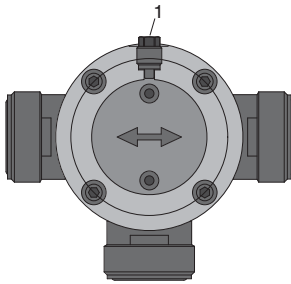

P_AC_0271_V2

1: Plug for manometer installation

Type	Nominal diameter	G	Order no.
PPE	DN 10	3/4	1077221
PPB	DN 10	3/4	1077259
PCE	DN 10	3/4	1077255
PCB	DN 10	3/4	1077263
PVT	DN 10	3/4	1077267
PPE	DN 15	1	1077220
PPB	DN 15	1	1077258
PCE	DN 15	1	1077254
PCB	DN 15	1	1077262
PVT	DN 15	1	1077266
PPE	DN 20	1 1/4	1077219
PPB	DN 20	1 1/4	1077257
PCE	DN 20	1 1/4	1077223
PCB	DN 20	1 1/4	1077261
PVT	DN 20	1 1/4	1077265
PPE	DN 25	1 1/2	1077218
PPB	DN 25	1 1/2	1077256
PCE	DN 25	1 1/2	1077222
PCB	DN 25	1 1/2	1077260
PVT	DN 25	1 1/2	1077264

Materials used

Type	Housing/Connectors	Plungers	Plunger Seal	Seal/Connectors
PPE	PP	PVDF	EPDM	EPDM
PPB	PP	PVDF	FKM	FKM
PCE	PVC	PVDF	EPDM	EPDM
PCB	PVC	PVDF	FKM	FKM
PVT	PVDF	PVDF	PTFE*	FKM

* Cover ring made of PTFE/FKM



1.8 Hydraulic/Mechanical Accessories

Dimensions of DHV-UR M (PP, PVC, PVDF design)

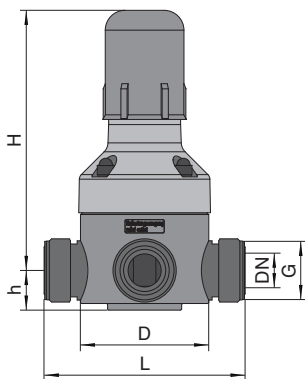

P_AC_0267_V2

DN	G	H mm	L mm	h mm	D mm	m	B mm
10	3/4	144*	118	24	79	M6	35
15	1	144*	118	24	79	M6	35
20	1 1/4	196*	150	37	99	M6	46
25	1 1/2	196*	150	37	99	M6	46

* Approximate values

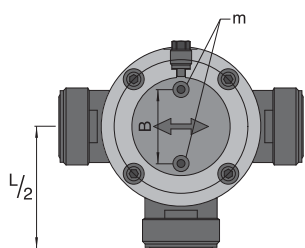

P_AC_0271_V2

Pipe spring manometer

Pipe spring manometers in accordance with DIN EN 837-1 for neutral media for use with relief valves DHV-UR design M. When ordered, the manometer is supplied with the relief valve.

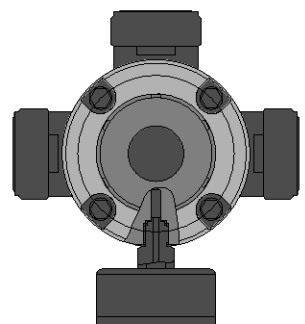

P_AC_0269

Nominal diameter	63 mm
Display range	0 – 16 bar
Housing material	1.4571
Material connector	Brass
Connector	Threaded assembly G 1/4" (ISO 228)
Connector position	radial at bottom
Filling liquid	Glycerine

Pipe spring manometer	Order no. 792726
------------------------------	----------------------------



1.8 Hydraulic/Mechanical Accessories

1

Back Pressure Valve / Relief Valve Type DHV 712-R

Adjustable pressure 0.5 – 10 bar

Applications of PPE / PCB

20 °C - max. operating pressure 10 bar

Applications of PVT / TT / SS

30 °C - max. operating pressure 10 bar

Type	G	Nominal diameter	Order no.
TT	3/4	DN 10	1000059
TT	1	DN 15	1000060
TT	1 1/4	DN 20	1000061
TT	1 1/2	DN 25	1000062
TT	2	DN 32	1000063
TT	2 1/4	DN 40	1000064

* **Caution:** The product contains adhesive joints with Tangit. Please note the resistance of Tangit adhesive.

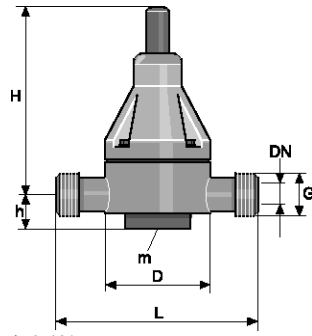

Dimensions of DHV 712-R

DN	G	H	L	h	D	m
		mm	mm	mm	mm	
32	2	260	205	59** / 37***	147	M8
40	2 1/4	260	205	59** / 37***	147	M8

* = Approx. values;
 ** = PP, PVC, PVDF;
 *** = TT, SS

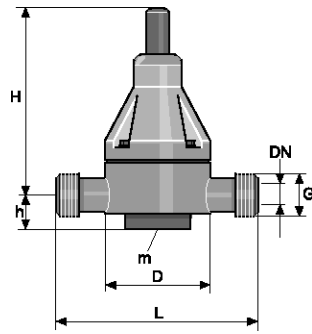

Materials

Type	Housing/Connectors	Plungers	Plunger Seal	Seal/Connectors
TT	PTFE with carbon	PTFE ²	PTFE ³	PTFE ³

² PTFE (white)
³ Packing ring PTFE/FKM



1.8 Hydraulic/Mechanical Accessories

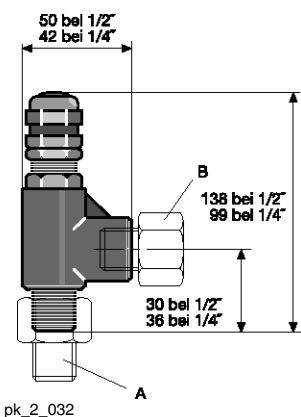

Back Pressure Valve / Relief Valve for High-Pressure Systems

Use as a pressure relief valve (adjustable) and as a back pressure valve. Overflow valve and corresponding spring must be ordered separately.

Material: stainless steel 316/FKM

Temperature range: -18 °C to 120 °C

Recommended Use up to 200 l/h

	Connection	Order no.
Overflow valve	1/4" NPT inner and outer thread	202505

Spring for pressure range	Spring colour	Order no.
3.4 – 24 bar	blue	202519
24.0 – 52 bar	yellow	202520
52.0 – 103 bar	violet	202525
103.0 – 155 bar	orange	202524
155.0 – 207 bar	brown	202523
207.0 – 276 bar	white	202522
276.0 – 345 bar	red	202521

Recommended Use up to 300 l/h

	Connection	Order no.
Overflow valve	1/2" NPT inner and outer thread	1005499

Spring for pressure range	Spring colour	Order no.
3.4 – 24 bar	blue	1005500
24.0 – 50 bar	yellow	1005501
50.0 – 100 bar	violet	1005502

Reducing Pipe Nipple

Connection	Order no.
1/4" NPT internal – 1/4" NPT external (A)	359378
1/4" NPT external – 1/4 Rp internal (B)	359379
1/2" NPT internal – 1/2" NPT external (A)	1005503
1/2" NPT external – 1/2 Rp internal (B)	1005504

For use as an adjustable safety relief valve and as a back pressure valve. Relief valve and corresponding spring must be ordered separately



1.8 Hydraulic/Mechanical Accessories

1.8.4 Suction Lances, Suction Assemblies and Level Switches for Motor-Driven Metering Pumps

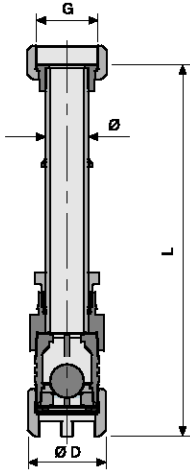

P_AC_0203_SW

Suction assembly PPE for tanks up to 1,500 litres

Connection	G	Storage tank l	Ø mm	Ø D mm	L mm	Order no.
DN 10	3/4	1000	20	47	1,340	790389
DN 15	1	1000	20	47	1,320	790394
DN 20	1 1/4	1000	25	55	1,345	790395
DN 25	1 1/2	1000	32	60	1,315	790396
DN 32	2	1000	40	74	1,170	1005524
DN 10	3/4	1500	20	47	1,830	1077554

Suction assembly without level switch comprising a support pipe, foot valve and threaded connector. The length L of the support pipe can be adjusted (shortened) by the customer.

Note: In applications with a hose, the suction assembly/hose connector kit, consisting of a PVDF screw-in nozzle and a PTFE composite seal, can be used.

Suction assembly PCB for tanks up to 1,500 litres

Connection	G	Storage tank l	Ø mm	Ø D mm	L mm	Order no.
DN 10	3/4	1000	20	47	1,340	790387
DN 15	1	1000	20	47	1,320	790391
DN 20	1 1/4	1000	25	55	1,345	790392
DN 25	1 1/2	1000	32	60	1,315	790393
DN 32	2	1000	40	74	1,170	1005525
DN 10	3/4	1500	20	47	1,830	1077555

Suction assembly without level switch comprising a support pipe, foot valve and threaded connector. The length L of the support pipe can be adjusted (shortened) by the customer.

Note: In applications with a hose, the suction assembly/hose connector kit, consisting of a PVDF screw-in nozzle and a PTFE composite seal, can be used.

Important: The product contains connections bonded with Tangit. Always note the durability of Tangit adhesive.

Level Switch Kit Complete, PVDF, Two-Stage with Round Connector or Lead

The level switch kit can be ordered together with the suction fittings DN 10 - DN 32.

For level monitoring in the storage tank, two-phase with pre-alarm signalling and deactivation of the metering pump after a further level decrease of 30 mm.

Technical data:

- Max. switching voltage: 100 V
- Switching current: 0.5 A
- Switching capacity: 5 W/5 VA
- Temperature range: - 10 °C to 65 °C
- IP rating: IP 67

Switching mode: for level shortage 2 x NC

Material:

Body level switch PVDF, float PE, mounting strap PVDF, cable bracket PE, anti-kink device PE, cable PE.

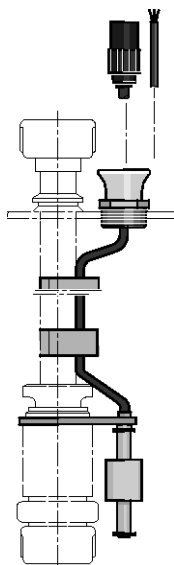

pk_2_035

Connection	Type	Cable length m	Order no.
DN10/15	with 3-pin round plug	3	1034879
DN 20	with 3-pin round plug	3	1034880
DN 25	with 3-pin round plug	3	1034881
DN 32	with 3-pin round plug	3	1034882
DN 10/DN 15	with lead	5	1034883
DN 20	with lead	5	1034884
DN 25	with lead	5	1034885
DN 32	with lead	5	1034886

1.8 Hydraulic/Mechanical Accessories

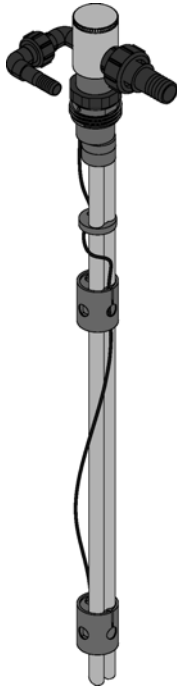

P_AC_0252_SW

- A Overall length
- B Immersion depth
- C Diameter of the immersion tube
- D Threaded connector adjustment range
- E Warning level adjustment range
- F Switch-off level adjustment range

PPE Universal Suction Lance

Universal suction lance made of PP in 4 sizes for use in canisters, barrels or containers. The suction lance is configured as standard with return, ventilation function and 2-stage level monitoring. The height-adjustable level switch and tank threaded connectors ensure flexible adaptation to the process or storage tank height. In addition, the suction tube length can easily be shortened by the customer. A PTFE check ball is incorporated and prevents the suction line from running dry. With IBC container suction lances (1039399, 1046672), the screw lid DN150 can be installed by the customer onto other G2" vent openings.

Note: Special designs are available on request.

The suction lance is supplied with all additional parts in cardboard packaging.

Material version: PP with EPDM seals.

Suction connector is not supplied ready mounted. Fittings and pressure hose nozzles in DN 10, DN 15, DN 20, DN 25 (not for canisters) plus FKM seal do not form part of the scope of delivery.

Return connector is not supplied ready mounted. Fittings and pressure hose nozzles in DN 10, DN 15, plus an FKM blanking plug and seal do not form part of the scope of delivery.

Level: In drum and tank lances the level switches are protected by tube pieces. The lance level output is in the form of an M12 plug. Please order the level signal cable for connection to ProMinent metering pumps or a PLC or terminal box separately.

Storage tank connector:

- 20 l and 20 - 60 l canisters: Ø 50 screw lid
- 200 l drum: 70 x 6 opening in plastic bung drum
- IBC container: DN150 IBC cap

General Electrical Accessories → 1-84

Universal suction lance	A	B	C	Total adjustment range			Order no.
				D	E	F	
	mm	mm	mm	mm	mm	mm	
For canister 20 l	542	405	41	100	250	200	1039206
For canister 20 -60 l	584	447	41	100	300	200	1038817
For drum 200 l	1,072	935	51	50	700	700	1039397
For container IBC	1,162	1,025	51	50	800	800	1039399

PPE Universal Suction Lance, "Physiologically Safe" Design

The universal suction lance is also available as a "Physiologically safe (FDA) in respect of wetted materials" design.

Universal suction lance	A	B	C	Total adjustment range			Order no.
				D	E	F	
	mm	mm	mm	mm	mm	mm	
For 20-litre canister	542	405	41	100	250	200	1046668
For 20 – 60-litre canister	584	447	41	100	300	200	1046670
For 200-litre drum	1,072	935	51	50	700	700	1046671
for IBC containers*	1,162	1,025	51	50	800	800	1046672

*Replace the screw lid when using FDA containers.



1.8 Hydraulic/Mechanical Accessories

1

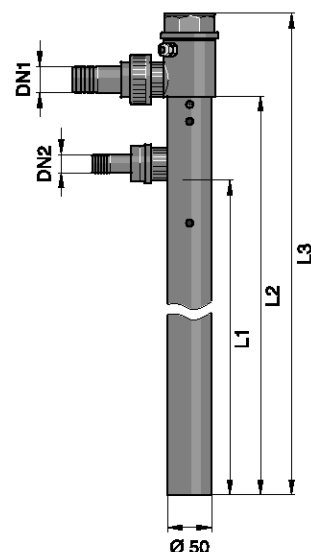

P_AC_0277

Suction Lance with Two-Stage Level Switch

Suction lance with 2-stage level switch in Ø 50 PVC protection tube with check valve for DN 10-DN 25, clack valve in DN 32 (valve is not removable).

For sizes DN 10/15 and DN 20/25, the connection parts in both sizes and a blanking plate for the return form part of the scope of supply. For the DN 32 suction lance a return line is not possible. Drum suction lances are equipped with a drum lid.

2-stage level switch is wired to a terminal in the head.

The level sensor cable must be ordered separately.

Special designs (materials, functions, Dytex adhesive etc.) are available on request.

Reed cable with 3-pin round plug, PE → 1-84

* **Caution:** The product contains adhesive joints with Tangit. Please note the resistance of Tangit adhesive.

Suction Lance for 200/600 l Drum

Type	Suction connector DN 1	Return DN 2	Seals	L1	L2	L3	Order no.
				mm	mm	mm	
PCB	10/15	10/15	FKM	1000	1100	1200	1037748
PCE	10/15	10/15	EPDM	1000	1100	1200	1037749
PCB	20/25	20/25	FKM	1000	1100	1200	1037750
PCE	20/25	20/25	EPDM	1000	1100	1200	1037751
PCB	32	–	FKM		1100	1200	1037752
PCE	32	–	EPDM		1100	1200	1037753

L1: Length up to return

L2: Length up to suction connector

L3: Overall length

Suction Lance for 1000 l Tank

Type	Suction connector DN 1	Return DN 2	Seals	L1	L2	L3	Order no.
				mm	mm	mm	
PCB	10/15	10/15	FKM	1200	1300	1400	1037722
PCE	10/15	10/15	EPDM	1200	1300	1400	1037723
PCB	20/25	20/25	FKM	1200	1300	1400	1037744
PCE	20/25	20/25	EPDM	1200	1300	1400	1037745
PCB	32	–	FKM		1300	1400	1037746
PCE	32	–	EPDM		1300	1400	1037747

L1: Length up to return

L2: Length up to suction connector

L3: Overall length

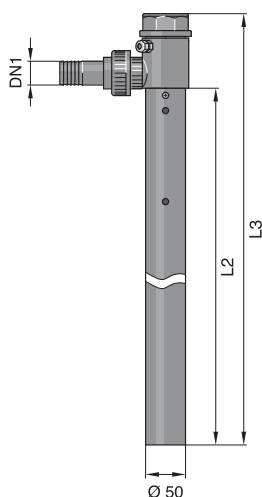

P_AC_0276

Intake Fitting – Hose Connection Kit

Consisting of PVDF threaded socket and a PTFE-formed composite seal.

Suitable for PPE Suction assembly for 1,000 l tank → 1-64

Connection	G	Material	Ø D mm	Order no.
DN 10	3/4	PVDF	16	1029486
DN 15	1	PVDF	20	1029487
DN 20	1 1/4	PVDF	25	1029488
DN 25	1 1/2	PVDF	32	1029489
DN 32	2	PVDF	40	1029490

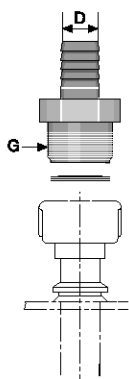

pk_2_140





1.8 Hydraulic/Mechanical Accessories

1.8.5 Fittings

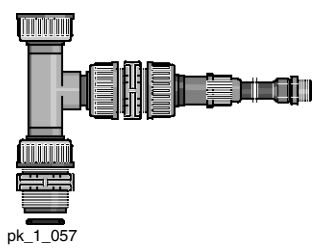

pk_1_057

Flushing Assemblies for Motor-Driven Metering Pumps

Flushing assemblies for flushing and cleaning liquid end, metering line and metering valve as well as for preventing deposits.

PPE Flushing Device

Connection	G	Order no.
DN 10	3/4	809917
DN 15	1	809919
DN 20	1 1/4	809921
DN 25	1 1/2	809923

PCB Flushing Assembly

Connection	G	Order no.
DN 10	3/4	809926
DN 15	1	803960
DN 20	1 1/4	803961
DN 25	1 1/2	803962
DN 40	2 1/4	803963

*** Caution:** The product contains adhesive joints with Tangit. Please note the resistance of Tangit adhesive. Automatic flushing equipment for the fully automatic flushing of the pump head is possible on request.

1.8 Hydraulic/Mechanical Accessories

1.8.6 Pulsation Damper

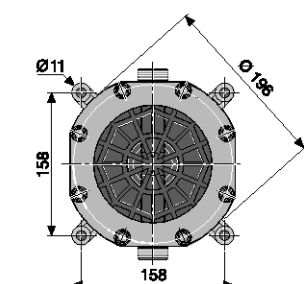
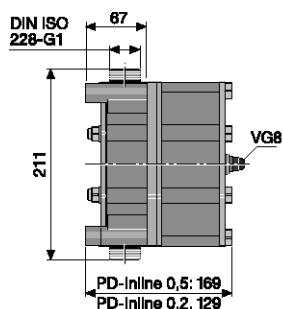

PVDF In-Line Pulsation Damper

Function: Hydropneumatic accumulator with baffle

The PVDF accumulator with PTFE diaphragm offers outstanding resistance to chemicals and can therefore be used in connection with a large number of different liquids. The pulsation damper has two liquid connections and can therefore be installed directly in the piping system or be installed diagonally using a blanking plug kit. The baffle in the liquid valve directs the volume flow straight at the diaphragm. This ensures direct contact of the volume flow with the diaphragm. Fluctuations in volume flow are thus optimally balanced out by the enclosed gas volume.

Important: Pulsation dampers should be protected by an overflow valve.

Type	Volume l	Max. pressure bar	Connection	Order no.
PD In-line	0.2	10	G 1 – DN 15	1026252
PD In-line	0.5	10	G 1 – DN 15	1026736
PD-Inline	0.2	16	G 1 – DN 15	1033446
PD-Inline	0.5	16	G 1 – DN 15	1033447
PD-Inline	0.2	25	G 1 – DN 15	1036154
PD In-line	0.5	25	G 1 – DN 15	1036155

The priming pressure is approximately 0.6 x the operating pressure. Maximum medium temperature, 65 °C. Connection parts must be ordered separately.

Filling of the reservoir with nitrogen takes place via the VG8 gas filling connector or with compressed air using a standard filling valve (e.g. a car tyre valve).

Attention: If using combustible liquids, nitrogen must be used as a filling gas. Do not use oxygen under any circumstances!

Configuration: DGRL97/23/EC, other acceptances / countries upon request

Fluid group: 1 and 2

Certificates: Manufacturer's test certificate M DIN55350-18
Wetted materials - FDA physiologically safe

Manufacturer: HYDAC Technology

Connection/Adapter Kits

Consisting of PTFE-formed composite seal, insert/adapter and union nut.

Connection PD In-line	Connection Piping	Material	Order no.
G 1 – DN 15	DN 10	PP	1029424
G 1 – DN 15	DN 10	PVC	1029425
G 1 – DN 15	DN 10	PVDF	1029426
G 1 – DN 15	DN 15	PP	1029443
G 1 – DN 15	DN 15	PVC	1029444
G 1 – DN 15	DN 15	PVDF	1029445
G 1 – DN 15	DN 20	PP	1029427
G 1 – DN 15	DN 20	PVC	1029428
G 1 – DN 15	DN 20	PVDF	1029429
G 1 – DN 15	DN 25	PP	1029430
G 1 – DN 15	DN 25	PVC	1029431
G 1 – DN 15	DN 25	PVDF	1029432

Accessories/Spare Parts

	Material	Order no.
Set of plugs	PVDF/PTFE	1029446
Valve tool for gas valve insert	Steel	1029661
Separating diaphragm	PTFE/NBR	1025235
Gas valve assembly	1.4571/FKM/PTFE/MS	1029513
Gas valve insert	FKM/PTFE /MS	1029514
Gas valve insert	FKM/PTFE /NIRO	1029515
Manometer with connection adapter	–	1031556
Charging hose with connector for compressed air system, 25 bar; 2.5 m	–	1036156
Charging hose with connector for nitrogen bottle or pressure reducer	–	1036157

1



1.8 Hydraulic/Mechanical Accessories

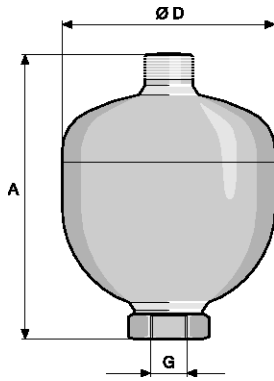

pk_2_101

Admissible operating temperature: -10 to +80 °C. Response pressure: 2 bar (nitrogen). Other accumulator/diaphragm materials available on request.

Stainless Steel Pulsation Damper

Volume l	Max. pressure bar	Diaphragm material	Connector G	A mm	Ø D mm	Order no.
0.16	180	NBR	Rp 1/2	124	74	1008609
0.16	180	Butyl	Rp 1/2	124	74	1008610
0.16	180	FKM	Rp 1/2	124	74	1008611
0.32	160	NBR	Rp 1/2	137	93	1008612
0.32	160	Butyl	Rp 1/2	137	93	1008613
0.32	160	FKM	Rp 1/2	137	93	1008644
0.75	140	NBR	Rp 1/2	168	121	1008645
0.75	140	Butyl	Rp 1/2	168	121	1008646
0.75	140	FKM	Rp 1/2	168	121	1008647
2.00	100	NBR	Rp 3/4	224	167	1008648
2.00	100	Butyl	Rp 3/4	224	167	1008649
2.00	100	FKM	Rp 3/4	224	167	1008650
4.00	50	NBR	Rp 3/4	360	170	1008651
4.00	50	Butyl	Rp 3/4	360	170	1008652
4.00	50	FKM	Rp 3/4	360	170	1008653
0.75	140	NBR	Rp 1	168	121	1027617
0.75	140	Butyl	Rp 1	168	121	1027618
0.75	140	FKM	Rp 1	168	121	1027619
2.00	100	NBR	Rp 1 1/2	224	167	1027620
2.00	100	Butyl	Rp 1 1/2	224	167	1027621
2.00	100	FKM	Rp 1 1/2	224	167	1027622
4.00	50	NBR	Rp 1 1/2	360	170	1027623
4.00	50	Butyl	Rp 1 1/2	360	170	1027624
4.00	50	FKM	Rp 1 1/2	360	170	1027625

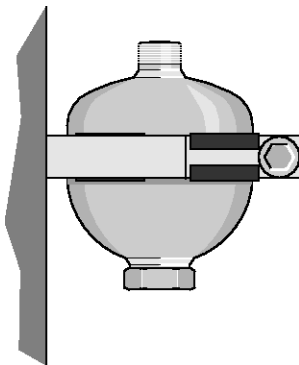

pk_2_102

Mounting Clamp for Stainless Steel Pulsation Damper

Volume l	Number of Clamps	Ø D mm	Order no.
0.16	1	74	1008664
0.32	1	93	1008665
0.75	1	121	1008666
2.00	1	167	1008667
4.00	2	170	1008668

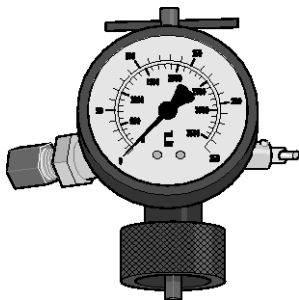

pk_2_116

Inflation and testing unit for pulsation damper

The inflation and testing unit is used to recharge accumulators with nitrogen and check or alter the existing pre-filling pressure.

It contains:

- Checking and filling system with pressure gauge, non-return valve on the inlet, integrated bleed valve, valve stem to open gas inlet valve on accumulator.
- Charging hose, Length 2 m

Adjustment range	Order no.
Up to 25 bar	1008769
Up to 100 bar	1008669
Up to 250 bar	1008670



1.8 Hydraulic/Mechanical Accessories

1

Pulsation Damper (in-line)

The pulsation damper is used to produce minimal pulsation metering and to reduce flow resistance in long discharge lines.

The gas cushion between the housing and the line is compressed at a pressure stroke of the metering pump, a partial quantity of the medium being simultaneously metered into the metering line. The excess pressure generated in the gas cushion has the effect of allowing the compressed volume to continue to be transported with the following suction stroke and the original, relieved gas volume is restored.

Important notice: The pulsation damper should be used in conjunction with a relief valve.

PP In-Line Damper

Damper diaphragm is replaceable, seals made of EPDM.

Medium temperature max. 50 °C

Pre-pressure is approx. 0.6 x operating pressure.

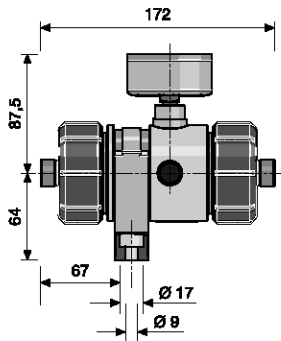

P_AC_0180_SW

	Volume l	Max. pressure bar	Damper diaphragm	Connection	Order no.
PPE in-line damper	0.05	10	CSM*	G 3/4 - DN 10	1026769
PPB in-line damper	0.05	10	FKM	G 3/4 - DN 10	1026772
PDS 2.5	2.50	10	Hypalon	G 2 - DN 32	1001344
PDS 2.5	2.50	10	FKM	G 2 - DN 32	1001345

* Chlorosulfonated polyethylene

For other sizes (0.2 l and 0.5 l) see in-line pulsation damper PVDF.

For other sizes (0.2 l and 0.5 l), see PVDF inline pulsation damper.

PVC In-Line Damper

Removable hose, FKM seals.

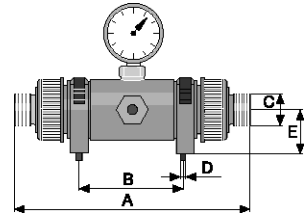

pk_2_041

	Volume l	Max. pressure bar	Damper diaphragm	Connection	Order no.
PCE in-line damper	0.05	10	CSM*	G 3/4 - DN 10	1026775
PCB in-line damper	0.05	10	FKM	G 3/4 - DN 10	1026778
PDS 2.5	2.50	10	Hypalon	G 2 - DN 32	1001342
PDS 2.5	2.50	10	FKM	G 2 - DN 32	1001343

* Chlorosulfonated polyethylene

For other sizes (0.2 l and 0.5 l) see in-line pulsation damper PVDF.

Type	Dimensions				
	A	B	C	D	E
PDS 2.5	541	525	G2	11	99.5



1.8 Hydraulic/Mechanical Accessories

1.8.7 Accumulators

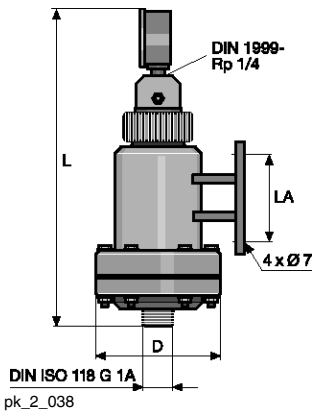

Pulsation dampers with separating bubble for providing separation between the gas cushion and metered chemical are used for low-pulsation metering as well as for reducing the flow resistance in long metering lines and in connection with viscous media. The response pressure of the gas cushion should be approx. 60-80 % of the operating pressure.

Important: When using a pulsation damper, the pressure relief valve should be fitted with an adjustable back pressure valve.

PVC Accumulators

Accumulator removable, FKM seals.

Operating range (0.5 / 1 l)

25 °C - max. operating pressure 10 bar

40 °C - max. operating pressure 6 bar

Operating range (2.5 / 5 l)

25 °C - max. operating pressure 6 bar

40 °C - max. operating pressure 4 bar

Volume	Diaphragm material	Connection	L	Ø D	LA	Order no.
l			mm	mm	mm	
0.5	Butyl	G 1 - DN 15	361	145	100	791691
0.5	FKM	G 1 - DN 15	361	145	100	791695
1.0	Butyl	G 1 1/4 - DN 20	411	170	100	791692
1.0	FKM	G 1 1/4 - DN 20	411	170	100	791696
2.5*	Butyl	G 1 1/2 - DN 25	571	170	190	791693
2.5*	FKM	G 1 1/2 - DN 25	571	170	190	791697

* **Caution:** The product contains adhesive joints with Tangit. Please note the resistance of Tangit adhesive.

PP Accumulators

Accumulator removable, FKM seals.

Operating range (0.5 / 1 l)

25 °C - max. operating pressure 10 bar

40 °C - max. operating pressure 6 bar

Operating range (2.5 / 5 l)

25 °C - max. operating pressure 6 bar

40 °C - max. operating pressure 4 bar

Volume	Diaphragm material	Connection	L	Ø D	LA	Order no.
l			mm	mm	mm	
0.5	Butyl	G 1 - DN 15	361	145	100	792128
0.5	FKM	G 1 - DN 15	361	145	100	792132
1.0	Butyl	G 1 1/4 - DN 20	411	170	100	792129
1.0	FKM	G 1 1/4 - DN 20	411	170	100	792133
2.5	Butyl	G 1 1/2 - DN 25	571	170	190	792130
2.5	FKM	G 1 1/2 - DN 25	571	170	190	792134



1.8 Hydraulic/Mechanical Accessories

1.8.8 Accumulators Without Diaphragm

Pulsation dampers with no diaphragm separating the gas cushion and the chemical are used to produce minimal pulsation metering and to reduce flow resistance in long pipes and when metering viscous liquids.

Important: When using accumulators or pulsation dampers it is imperative that a relief valve with an adjustable back pressure valve is fitted.

1

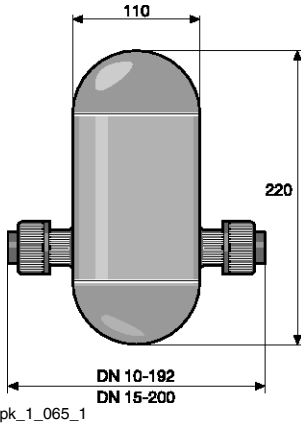

PP In-Line Pressure Accumulator

Operating range

20 °C - max. operating pressure 10 bar

40 °C - max. operating pressure 6 bar

	Volume	Permissible displacement	Connection	Order no.
	I			
Size II	1	up to 5 ml	G 3/4 – DN 10	243219
Size II	1	up to 5 ml	G 1 – DN 15	243220

PVC In-Line Accumulator

Operating range

20 °C - max. operating pressure 10 bar

40 °C - max. operating pressure 6 bar

	Volume	Permissible displacement	Connection	Order no.
	I			
Size II	1	up to 5 ml	G 3/4 – DN 10	243204
Size II	1	up to 5 ml	G 1 – DN 15	243205

* **Caution:** The product contains adhesive joints with Tangit. Please note the resistance of Tangit adhesive.



1.8 Hydraulic/Mechanical Accessories

PP Pressure Accumulator

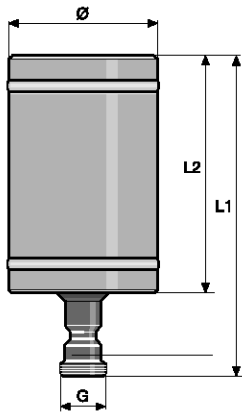

pk_2_042

Volume l	Connection		Ø mm	L1 mm	L2 mm	Order no.
2	G 1 1/4 – DN 20	without connector parts	140	290	220	243211
4	G 1 1/2 – DN 25	without connector parts	160	410	320	243212

PVC Pressure Accumulator

Operating range

20 °C - max. operating pressure 10 bar

40 °C - max. operating pressure 6 bar

Volume l	Connection		Ø mm	L1 mm	L2 mm	Order no.
2	G 1 1/4 – DN 20	without connector parts	140	290	220	243207
4	G 1 1/2 – DN 25	without connector parts	160	410	320	243208

* **Caution:** The product contains adhesive joints with Tangit. Please note the resistance of Tangit adhesive.

Stainless Steel Accumulator

Max. operating pressure 10 bar

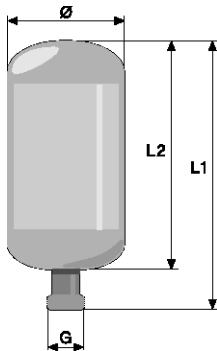

pk_2_033

Volume l	Connection		Ø mm	L1 mm	L2 mm	Order no.
2	G 1 1/4 – DN 20	without connector parts	140	272	222	243214
4	G 1 1/2 – DN 25	without connector parts	160	365	312	243215

Wall Bracket for Accumulator

Consists of pipe clamp, mounting plate and connecting nipple.

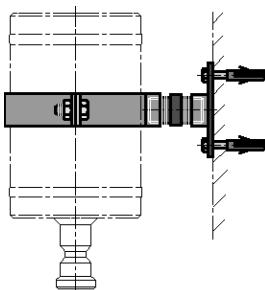

pk_1_061

	Ø mm	Order no.
For accumulator volume 2 l	110	818502
For accumulator volume 2 l	140	803645
For accumulator volume 4 l	160	803646



1.8 Hydraulic/Mechanical Accessories

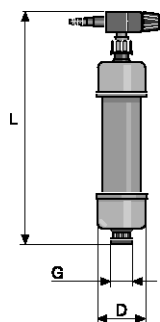

pk_2_044

PVC Vacuum Cylinder

Vacuum cylinder as priming aid for long suction line and viscous media. Housing – with transparent middle section. With connector for vacuum pump.

Max. operating pressure: 2 bar at 40 °C operating temperature.

Max. permitted vacuum pressure 300 mbar absolute

With this: Vacuum pump assembly

Volume l	Connection	Seal material	L mm	D mm	Order no.
0.5	G 1 – DN 15	FKM	380*	78	243591
0.5	G 1 – DN 15	EPDM	380*	78	1025699
1.0	G 1 1/4 – DN 20	FKM	440*	86	243592
1.0	G 1 1/4 – DN 20	EPDM	440*	86	1025701
2.5	G 1 1/2 – DN 25	FKM	520*	133	243593
2.5	G 1 1/2 – DN 25	EPDM	520*	133	1025702
5.0	G 2 1/4 – DN 40	FKM	630*	155	243594
5.0	G 2 1/4 – DN 40	EPDM	630*	155	1025703

* Approximate values

* **Caution:** The product contains adhesive joints with Tangit. Please note the resistance of Tangit adhesive.

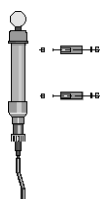

pk_2_045

Vacuum Pump Assembly / Priming Aid

For pulsation dampers, suction side (vacuum cylinder accumulator).

Material	Seals	Order no.
PVC	EPDM	790019

* **Caution:** The product contains adhesive joints with Tangit. Please note the resistance of Tangit adhesive.

Suction pressure regulator

The suction pressure regulator is a spring-loaded diaphragm valve (max. 50 l/h) which opens as a result of the pump suction pressure. This ensures that chemicals cannot flow when the pump is not running, nor can a vacuum be created as a result of tube rupture.

A ball check valve should be fitted to prevent undesirable suction action at the pump outlet (e.g. siphon effect).

An adjustable spring is used to set the maximum required negative pressure for each operating situation up to 400 mbar. For pumps with positive inlet pressure a minimal vacuum of approx. 50 mbar is sufficient. The pump should produce this vacuum in any case, even for an atmospheric pressure inlet.

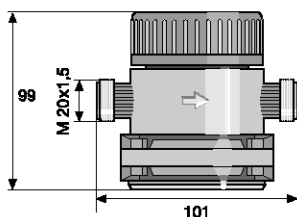

pk_2_079

Technical Data

Max. flow rate	50 l/h
Max. feed pressure	4 bar
Max. intake pressure	0.3 bar
Max. temperature	40 °C
Housing material	PVC
Diaphragm material	FKM
Seals	FKM
Ball material	Glass
Spring material	Hastelloy C

Type	Connection	Order no.
SDR 50 For solenoid-driven pumps	M 20 x 1.5	1005505
SDR 50 For motor-driven pumps up to 50 l/h	G 3/4 - DN 10	1005506

Connection parts to be ordered separately.

* **Caution:** The product contains adhesive joints with Tangit. Please note the resistance of Tangit adhesive.



1.8 Hydraulic/Mechanical Accessories

1.8.9 Connectors and Seals for Motor-Driven Metering Pumps

Union Nuts

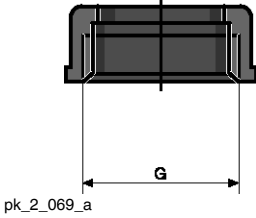

Union nut	Material	Connection	Order no.
	PP	G 5/8 – DN 8	800665
	PP	G 3/4 – DN 10	358613
	PP	G 1 – DN 15	358614
	PP	G 1 1/4 – DN 20	358615
	PP	G 1 1/2 - DN 25	358616
	PP	G 2 - DN 32	358617
	PP	G 2 1/4 - DN 40	358618
	PP	G 2 3/4 - DN 50	358619
	PVC	G 5/8 – DN 8	800565
	PVC	G 3/4 – DN 10	356562
	PVC	G 1 – DN 15	356563
	PVC	G 1 1/4 – DN 20	356564
	PVC	G 1 1/2 - DN 25	356565
	PVC	G 2 - DN 32	740690
	PVC	G 2 1/4 - DN 40	356567
	PVC	G 2 3/4 - DN 50	356568
	PVDF	G 3/4 – DN 10	358813
	PVDF	G 1 - DN 15	358814
	PVDF	G 1 1/4 - DN 20	358815
	PVDF	G 1 1/2 - DN 25	358816
	PVDF	G 2 - DN 32	1003639
	PVDF	G 2 1/4 - DN 40	358818
	PVDF	G 2 3/4 - DN 50	358819
	1.4571	G 3/4 – DN 10	805270
	1.4571	G 1 - DN 15	805271
	1.4571	G 1 1/4 - DN 20	805272
	1.4571	G 1 1/2 - DN 25	805273
	1.4571	G 2 - DN 32	805274
	1.4571	G 2 1/4 - DN 40	805275
	1.4571	G 2 3/4 - DN 50	805276

Insert

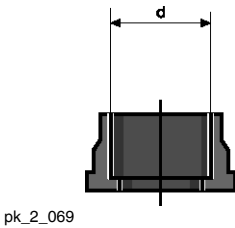

Fusion socket	Material	Connection	Order no.
	PP	d 12 – DN 8	800666
	PP	d 16 – DN 10	358603
	PP	d 20 – DN 15	358604
	PP	d 25 – DN 20	358605
	PP	d 32 – DN 25	358606
	PP	d 40 – DN 32	358607
	PP	d 50 – DN 40	358608
	PP	d 63 – DN 50	358609
	PVDF	d 16 – DN 10	358803
	PVDF	d 20 – DN 15	358804
	PVDF	d 25 – DN 20	358805
	PVDF	d 32 – DN 25	358806
	PVDF	d 40 – DN 32	1003640
	PVDF	d 50 – DN 40	358808
	PVDF	d 63 – DN 50	358809



1.8 Hydraulic/Mechanical Accessories

1

	Material	Connection	Order no.
Fusion coupler, grooved*	PP	d 16 – DN 10	1001785
	PP	d 20 – DN 15	1001395
	PP	d 25 – DN 20	1036258
	PP	d 32 – DN 25	1001787
	PP	d 40 – DN 32	1005105
	PP	d 50 – DN 40	1025960
	PP	d 63 – DN 50	1019207
	PVDF	d 16 – DN 10	358803
	PVDF	d 20 – DN 15	358804
	PVDF	d 25 – DN 20	1036259
	PVDF	d 32 – DN 25	1001788
	PVDF	d 40 – DN 32	1003640
	PVDF	d 50 – DN 40	1025959
	PVDF	d 63 – DN 50	1019208

* To be used together with ProMinent® PTFE formed composite seals.

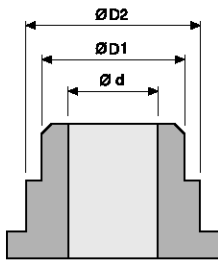

P_AC_0210_SW

	Material	Ø D1 mm	Ø D2 mm	Connection	Order no.
SS fusion coupler, grooved	1.4404	15.0	19.5	d 12 – DN 10	1006011
	1.4404	21.0	25.6	d 16 – DN 15	1006001
	1.4404	26.7	33.6	d 22 – DN 20	1031457
	1.4404	33.4	39.6	d 28 – DN 25	1031458
	1.4404	42.2	49.6	d 36 – DN 32	1031459
	1.4404	48.3	57.5	d 40 – DN 40	1023643
	1.4404	71.6	60.3	d 54 – DN 50	1031460

	Material	Connection	Order no.
Adhesive socket	PVC	d 16 – DN 10	356572
	PVC	d 20 – DN 15	356573
	PVC	d 25 – DN 20	356574
	PVC	d 32 – DN 25	356575
	PVC	d 40 – DN 32	356576
	PVC	d 50 – DN 40	356577
	PVC	d 63 – DN 50	356578

	Material	Connection	Order no.
Adhesive coupler, grooved*	PVC	d 16 – DN 10	1001784
	PVC	d 20 – DN 15	1001394
	PVC	d 25 – DN 20	1036257
	PVC	d 32 – DN 25	1001786
	PVC	d 40 – DN 32	1005104
	PVC	d 50 – DN 40	1025961
PVC	d 63 – DN 50	1019206	

* To be used together with ProMinent® PTFE formed composite seals.

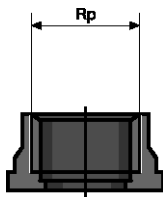

pk_2_069_b

	Material	Connection	Order no.
Threaded pipe socket	1.4404	Rp 3/8 – DN 10	805285
	1.4404	Rp 1/2 – DN 15	805286
	1.4404	Rp 3/4 – DN 20	805287
	1.4404	Rp 1 – DN 25	805288
	1.4404	Rp 1 1/4 – DN 32	805289
	1.4404	Rp 1 1/2 – DN 40	805290
1.4404	Rp 2 – DN 50	805291	



1.8 Hydraulic/Mechanical Accessories

Pressure Hose Nozzles



pk_2_046

	Material	Connection	Order no.
Pressure hose nozzle	PP	d 16 – DN 10	800657
	PP	d 20 – DN 15	800655
	PP	d 25 – DN 20	800656
	PP	d 32 – DN 25	811418
	PVC	d 16 – DN 10	800554
	PVC	d 20 – DN 15	811407
	PVC	d 25 – DN 20	811408
	PVC	d 32 – DN 25	811409
	PTFE	d 16 – DN 10	811572
	PTFE	d 20 – DN 15	811424
	PTFE	d 25 – DN 20	811425
	PTFE	d 32 – DN 25	811426
	PVDF	d 40 – DN 32	1005106
	1.4571	d 16 – DN 10	810536
	1.4571	d 20 – DN 15	810567
	1.4571	d 25 – DN 20	810568
	1.4571	d 32 – DN 25	810569
	1.4571	d 40 – DN 32	1005360

	Material	Connection	Order no.
Hose nozzle, grooved	PVDF	d 16 – DN 10	1002288
	PVDF	d 20 – DN 15	740632
	PVDF	d 25 – DN 20	1006014
	PVDF	d 32 – DN 25	1005560
	PVDF	d 40 – DN 32	1005106

To be used together with ProMinent® PTFE formed composite seals.

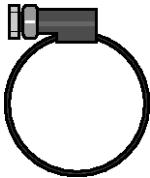

pk_1_068

Stainless Steel Threaded Clip

For connecting intake and metering line to pressure hose nozzle.

	Clamping range mm	Order no.
DN 10 clamping ring	16 – 25	359703
DN 15 clamping ring	20 – 32	359705
DN 20 clamping ring	25 – 40	359706
DN 25 clamping ring	32 – 50	359707
DN 32 clamping ring	40 – 60	1002777

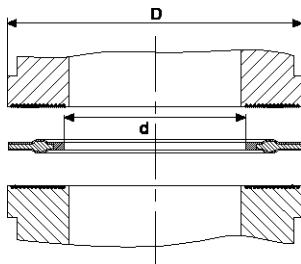

pk_2_130

PTFE Formed Composite Seals

Formed composite seals to be used on grooved sealing surfaces (e.g. pump valve and grooved inserts from ProMinent).

DN DIN / ANSI	Material	D mm	d mm	Order no.
DN 10	PTFE	23.8	14.0	1019364
DN 15	PTFE	29.5	18.0	1019365
DN 20	PTFE	38.0	22.6	1019366
DN 25	PTFE	44.0	27.6	1019367
DN 32	PTFE	56.0	34.6	1019353
DN 40	PTFE	62.0	40.6	1019368



1.8 Hydraulic/Mechanical Accessories

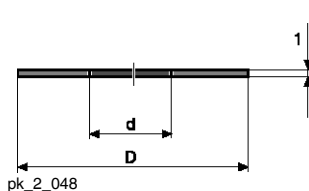

Set of elastomer flat packing seals

Comprising two EPDM and two FKM seals. An elastomer flat seal should be used with non-grooved sealing surfaces. Leaks may occur at the connection if a PTFE shaped composite seal is used.

	D	d	Order no.
	mm	mm	
DN 10	23.5	14.0	1024159
DN 15	29.5	18.0	1024160
DN 20	38.0	22.6	1036254
DN 25	44.0	28.0	1024161
DN 32	56.0	36.0	1024162
DN 40	62.0	41.0	1029508

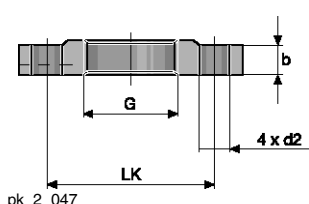

Flange Mountings

Flange connection in line with DIN 2566 for ProMinent® valve sizes.

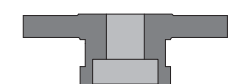

P_AC_0263_1_SW1
PVDF with collar

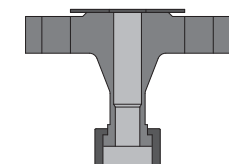

P_AC_0264_SW1
1.4571/1.4404 with collar

Material	G/DN	Pressure rating	b	Ø LK	d2	Order no.	
	DIN / ANSI	PN	mm	mm	mm		
PVDF	-	G 3/4 - DN 10	PN 16	12.4	60	14	1036274
PVDF	-	G 1 - DN 15	PN 16	13.0	65	14	1036275
PVDF	-	G 1 1/4 - DN 20	PN 16	15.0	75	14	1036276
PVDF	-	G 1 1/2 - DN 25	PN 16	16.0	85	14	1036277
PVDF	-	G 2 - DN 32	PN 16	18.0	100	18	1036278
PVDF	-	G 2 1/4 - DN 40	PN 16	20.0	100	18	1039037
1.4404	-	G 3/4 - DN 15	PN 40	12.0	65	14	803946
1.4404	-	G 1 - DN 15	PN 40	12.0	65	14	803940
1.4404	-	G 1 1/4 - DN 20	PN 40	15.0	75	14	803941
1.4404	-	G 1 1/2 - DN 25	PN 40	15.0	85	14	803942
1.4404	-	G 2 - DN 32	PN 40	18.0	100	18	1036283
1.4404	-	G 2 1/4 - DN 40	PN 40	20.0	110	18	803943
1.4404	-	G 2 3/4 - DN 50	PN 40	25.0	125	18	1020453
1.4404	-	G 2 1/2 - DN 65	PN 40	20.0	145	18	1010700
PVDF	with collar*	G 3/4 - DN 10	PN 16	12.5	60	14	1036279
PVDF	with collar*	G 1 - DN 15	PN 16	13.5	65	14	1036280
PVDF	with collar*	G 1 1/2 - DN 25	PN 16	16.0	85	14	1036281
PVDF	with collar*	G 2 - DN 32	PN 16	18.0	100	18	1036282
1.4571	with collar*	G 3/4 - DN 10 (DIN 2637)	PN 100	20.0	70	14	1006005
1.4571	with collar*	G 1 - DN 15 (DIN 2637)	PN 40	16.0	65	14	1006006
1.4404	with collar*	G 1 1/2 - DN 25 (DIN 1092-1)	PN 40	18.0	85	14	1041796
1.4404	with collar*	G 2 - DN 32 (DIN 1092-1)	PN 40	18.0	100	18	1041797

* Use flange mountings with a collar for pumps Sigma/ 1, Sigma/ 2 with DN 15 connector and Sigma/ 3 pumps with DN 25 connector. Sigma/ 3-DN25 1" EN 1092-11.4404 part no: 1041796

Further material versions and details available on request.

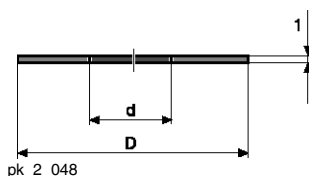

Flat Seals for Threaded Flange to DIN 2566

Material	G/DN	D	d	Order no.
	DIN / ANSI	mm	mm	
PTFE	G 3/4 - DN 15	52	12	483938
PTFE	G 1 - DN 15	52	17	483924
PTFE	G 1 1/4 - DN 20	62	22	483925
PTFE	G 1 1/2 - DN 25	72	27	483926
PTFE	G 2 - DN 32	83	33	1007541
PTFE	G 2 1/4 - DN 40	92	40	483928
PTFE	G 2 3/4 - DN 50	108	50	483929
PTFE	G 3 - DN 65	130	60	1020466
FKM	G 3/4 - DN 15	52	12	483939
FKM	G 1 - DN 15	52	17	483942



1.8 Hydraulic/Mechanical Accessories

Material	G/DN DIN / ANSI	D mm	d mm	Order no.
FKM	G 1 1/4 - DN 20	62	22	483943
FKM	G 1 1/2 - DN 25	72	27	483944
FKM	G 1 1/2 - DN 32	83	33	1007542
FKM	G 2 1/4 - DN 40	92	40	483946
FKM	G 2 3/4 - DN 50	108	50	483947
FKM	G 3 - DN 65	130	60	1020467

Flange mountings as DIN 2629. To order for Meta HK and Makro TZ HK plunger metering pumps.

FKM = Fluorine Rubber

Straight Male Adapter Stainless Steel

Swagelock system, stainless steel SS 316 (1.4401) for connection of pipework to liquid end and valves with internal thread and for SB version.

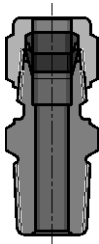

pk_1_028

	Order no.
6 mm - ISO 7 R 1/4	359526
8 mm - ISO 7 R 1/4	359527
12 mm - ISO 7 R 1/4	359528
12 mm - ISO 7 R 3/8	359520
16 mm - ISO 7 R 3/8	359521

Soft PVC Suction Line

For metering pumps and accessories. We recommend that only original tubing is used so that the mechanical connection of the compression fitting and the pressure rating and chemical resistance are ensured.

Supply with food-use certification is available upon request.

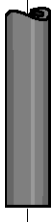

pk_1_013

Material	oØ x iØ mm		Permissible pressure bar	Order no.
PVC flexible	19 x 15	for DN 10	0.5*	037020
Flexible PVC	22 x 18	for DN 15	0.5*	037022

* Admissible operating pressure at 20 °C in accordance with DIN EN ISO 7751, subject to chemical resistance and correct assembly.

Caution:

The resistance of soft PVC hoses is not identical to that of hard PVC. Please observe the resistance for soft PVC as well as the cleaning instructions when using the equipment for food applications (see homepage).

* Permissible operating pressure at 20 °C, chemical resistance and proper connection assumed.



1.8 Hydraulic/Mechanical Accessories

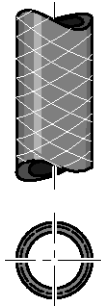

pk_1_060

Soft PVC Suction and Discharge Line with Woven Fabric Core

Supply with food-use certification is available upon request.

Material	oØ x iØ		Permissible pressure	Order no.
	mm			
Soft PVC with woven inner layer	24 x 16	for DN 10	15*	037040
Soft PVC with woven inner layer	27 x 19	for DN 15	15*	037041
Soft PVC with woven inner layer	34 x 25	for DN 20	12*	037043
Soft PVC with woven inner layer	40 x 30	for DN 25	10*	1000527
Soft PVC with woven inner layer	52 x 40	for DN 32	7*	1005508

* Admissible operating pressure at 20 °C in accordance with DIN EN ISO 7751, subject to chemical resistance and correct assembly.

Caution:

The resistance of soft PVC hoses is not identical to that of hard PVC. Please observe the resistance for soft PVC as well as the cleaning instructions when using the equipment for food applications (see homepage).

For socket welded and PVC cemented rigid PP and PVDF pipe, pipes and fittings with a pressure rating of PN 16 or PN 10 bar are to be used.

Stainless Steel Pipes

Material	Length	oØ x iØ		Permissible pressure	Order no.
		m	mm		
Stainless steel pipe 1.4435	Sold in metres	6 x 5	175*	015738	
	Sold in metres	6 x 4	185*	015739	
	Sold in metres	8 x 7	160*	015740	
	Sold in metres	12 x 10	200*	015743	

* Admissible operating pressure at 20 °C in accordance with DIN EN ISO 7751, subject to chemical resistance and correct assembly

Hose Cutting Kit

Hose Cutting Set for Plastic Pipes up to a Diameter of 25 mm. Manufacturer: Gedore.

	Order no.
Hose Cutting Kit	1038571



1.8 Hydraulic/Mechanical Accessories

1.8.10 Metering Pump Wall Mounting Bracket

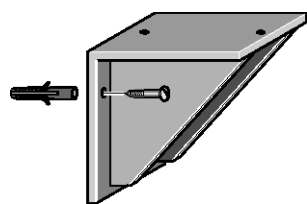

pk_2_036

PP Wall Bracket

PP wall mounting, holds pump parallel to the wall, includes fixings.

Measurements: L x W x H, 230 x 220 x 220 mm

Wall mounting bracket

for Vario, Sigma and Meta

Order no.

1001906

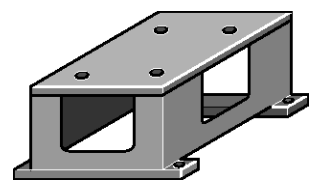

pk_2_037

PP Foot Bracket

For mounting metering pump, includes fixings. Material PP.

Measurements: L x W x H 250 x 160 x 150 mm

Foot bracket

Order no.

809910



1.9 Electrical Accessories

1.9.1 Speed Controllers

Frequency Converters for Speed Control

Frequency converters are installed in the IP 55 protective enclosure and are suitable for the motor output ratings listed below.

Integrated control unit with various functions optimally matched to ProMinent metering pumps: Selectable external/internal control, internal/external reset, temperature monitoring and control via PTC sensor, separate motor fan control as well as evaluation of diaphragm rupture monitoring.

Internal control: via potentiometer
 External control: 0/4-20 mA corresponding to 0-50 (60) Hz output frequency

Frequency converters can be used in the range of -10 °C to 40 °C.

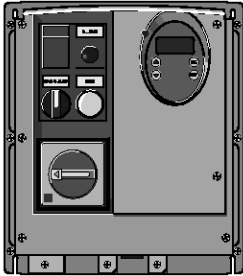

P_AC_0185_SW

Max. motor output kW	For pump type	Voltage supply	Voltage supply, external fan	Control range	Order no.
0.37	Sigma/ 1, Sigma/ 2, Meta, Hydro/ 2, MF1a, DR15	1 ph 200 – 240 V	230 V 50/60 Hz	1:10	1030684
0.75	Sigma/ 3, Hydro/ 3, MF2a	1 ph 200 – 240 V	230 V 50/60 Hz	1:10	1030685
1.50	Makro TZ, MF2a, MF3a, DR150	1 ph 200 – 240 V	230 V 50/60 Hz	1:10	1030686
2.20	Makro TZ, MF3a, DR150	1 ph 200 – 240 V	230 V 50/60 Hz	1:10	1030687
4.00	MF3a, MF4a	3 ph 380 – 500 V	3 ph 380 V	1:5	1030688

Dimensions and weight

Order no.	B mm	H mm	C mm	Weight kg
1030684	210	240	163	6.3
1030685	210	240	163	6.3
1030686	215	297	192	8.8
1030687	230	340	222	10.7
1030688	230	340	222	10.7

Variable speed motors with integrated frequency converter with IP 55 protection

Externally controllable with 0/4-20 mA (factory setting 4-20 mA)

Voltage supply: 1 ph 230 V, 50/60 Hz (0.37-1.1 kW)
 Voltage supply: 3 ph 400 V, 50/60 Hz (1.5-3 kW)

The following functions are integrated in the terminal box cover:

- Start/stop switch
- Switch for manual/external operation
- Potentiometer for speed control in manual mode.

Max. motor output kW	For pump	Control range	Flange Ø mm	Order no.
0.37	Hydro/ 2, Meta	1:20	160	1008569
0.75	Hydro/ 3	1:20	160	1008571
1.10	Makro TZ (TZMB)	1:20	160	1008572
1.50	Makro TZ	1:20	160	1008573
2.20	Makro TZ	1:20	200	1008574
3.00	Makro/ 5	1:20	250	1027482

Motor data sheets can be requested for more information. Motors for Sigma basic pumps, special motors or special motor flanges are available on request.

Motors less than 0.75 kW and motors designed for speed-controllable operation are not subject to the IE3 standard in compliance with the Ecodesign Directive 2009/125/EC.

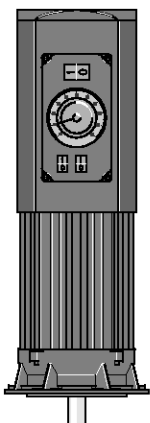

pk_2_103
 Variable speed motor with integrated frequency converter

1.9 Electrical Accessories

Operating unit for setting control parameters

	Order no.
With sub-D connector (old)	1020585
With Western connector (new)	1029493

Note:

Version suitable for use in ambient temperatures up to 55°C available on request.

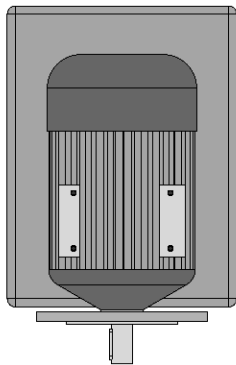

P_AC_0211_SW

Explosion-protected compact drive with integrated frequency converter Protection class II 2G Eexde II C T4

- Voltage supply: 400 V, 50/60 Hz
- Mains feed: 3 ph + neutral + earth
- Model: IM B5
- Inputs: 2 x analogue 0/4...20 mA
4 x digital (includes frequency input 0...100 kHz)
- Outputs: 2 x analogue 4...20 mA
4 x digital 0/+20 V, 10 mA
1 x frequency output 0...10 kHz, 0/18...24 V, max. 5 mA
- Terminal strip connectors: ON/OFF
Self-locking
RESET

Winding and temperature monitoring by PTC resistor with integral evaluation.

External control circuit: 230 V with internal fuse.

Note:

Delivery on request

Max. motor output kW	For pump	Control range	Flange Ø mm
0.55	Hydro/ 2, Sigma/ 3, Orlita MF	1:10	80
0.75	Hydro/ 3, Orlita MF	1:10	80
1.50	Makro TZ, Orlita MF	1:10	200
2.20	Makro TZ, Orlita MF	1:10	200
4.00	Makro/ 5, Orlita MF	1:10	250

Pumps with compact drive are always delivered on a frame.

Motor data sheets can be requested for more information.

Special motors or special motor flanges and other control ranges are available on request.

Motors less than 0.75 kW and motors designed for speed-controllable operation are not subject to the IEC standard in compliance with the Ecodesign Directive 2009/125/EC.



1.9 Electrical Accessories

1.9.2 General Electrical Accessories



pk_1_085

Universal signal cable

For control of the metering pump via potential-free contact, analogue standard signal and for potential-free ON/ OFF switching - switch-on function.

For Vario, S1Ca, S2Ca and S3Ca with 5-pin round plug made of plastic and 5-wire cable with open end.

	Cable length m	Order no.
Universal cable	2	1001300
Universal cable	5	1001301
Universal cable	10	1001302

Reed cable with 3-pin round plug, PE



P_AC_0243_SW

For Sigma metering pumps with 3-pin round plugs and a 3-core cable with an open end for level control.

Suitable for Suction lance for motor-driven metering pumps* → 1-66

	Cable length m	Order no.
Reed cable with 3-pin round plug, PE	2	1030334
	3	1030335
	5	1030336

Level sensor cable for connection of a universal suction lance and a motor-driven metering pump

For connection of the level switch of the universal suction lance for Sigma metering pumps or the higher-level control system (e.g. PLS).

Suitable for PPE universal suction lance for motor-driven metering pumps → 1-65



pk_1_126



P_AC_0243_SW

	Cable length m	Fig.	Order no.
Round plug coupling for M12 3-pin round plug	2	pk_1_126	1040962
Round plug coupling for M12 3-pin round plug	5	pk_1_126	1040963
Round plug coupling for M12 open end	1.1	P_AC_0243_SW	1009873
Round plug coupling for M12 open end	5	P_AC_0243_SW	1022537

Extension cable, 3-core

For 2-stage level switches, with round plug and round plug coupling.



pk_1_126

	Cable length m	Fig.	Order no.
Extension cable, 3-core	3	pk_1_126	1005559



1.9 Electrical Accessories

Profibus adaptor, IP 65 protection

From eurofast 5-pin M12 x 1, length approx. 500 mm.

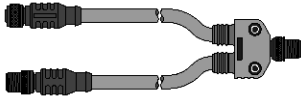

P_AC_0245_SW

		Fig.	Order no.
Y-adaptor 2 x M12 x 1 male/female	M12 x 1 male	P_AC_0245_SW	1040956
PROFIBUS® termination assembly, comprising a Y-plug and terminating resistance	M12	–	1040955
PROFIBUS® Y-adaptor	M 12 x 1	P_AC_0230_SW	1036621
PROFIBUS® termination resistor, plug-in	M 12 x 1	P_AC_0239_SW	1036622

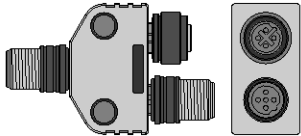

P_AC_0230_SW_1

USB adaptor

To connect a laptop to gamma and Sigma series metering pumps.

The USB adaptor can be used to transfer timer programmes created using ProTime software to the pump. You will find the ProTime software on our home page.

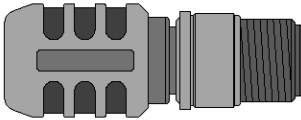

P_AC_0239_SW

	Order no.
USB Adaptor	1021544

Flow Control adjustable flow monitor

Suitable for product range Sigma/1/2/3 in material versions PVT and SST. Complete with connector cable for assembly directly on the dosing head.

For monitoring the individual strokes based on the floating body principle. The adjustment screw is used to match the partial flow flowing past the float to the set stroke volume so that an alarm is emitted if the level falls significantly below the required level. The permitted number of incompletely performed strokes can be selected between 1-150 on the Sigma Control (S1Cb/S2Cb/S3Cb), ensuring optimum adaptation to process requirements.

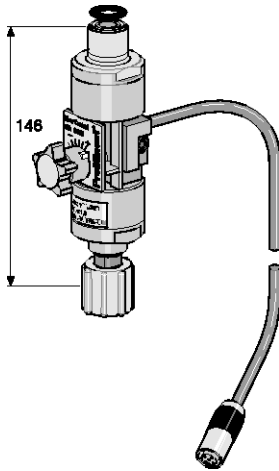

pk_1_086_2

Materials

Flow meter: PVDF
 Float: PTFE-coated
 Seals: FKM/EPDM

Flow Control	Seal material	For pump	Order no.
Flow Control DN 10	EPDM	Sigma/ 1	1021168
Flow Control DN 10	FKM	Sigma/ 1	1021169
Flow Control DN 15	EPDM	Sigma/ 1/ 2	1021170
Flow Control DN 15	FKM	Sigma/ 1/ 2	1021171
Flow Control DN 25	EPDM	Sigma/ 2/ 3	1021164
Flow Control DN 25	FKM	Sigma/ 2/ 3	1021165
Flow Control DN 32	EPDM	Sigma/ 3	1021166
Flow Control DN 32	FKM	Sigma/ 3	1021167



1.9 Electrical Accessories

1



Flow Meter DulcoFlow® for Sigma/ 1 Product Range

Your reliable control unit: unobtrusively measures, monitors and detects faults.

For the measurement of pulsating volumetric flows within the range of 0.03 ml/stroke to 10 ml/stroke

The flow meter DulcoFlow® reliably measures pulsating flows in the range above 0.03 ml/stroke based on the ultrasound measuring principle. The flow meter achieves maximum chemical resistance, as all wetted parts are made of PVDF and PTFE.

The device works on the ultrasound measuring principle. It was developed specifically for measuring small pulsating volumetric flows. It is installed around 30 cm downstream of the metering pump, so that there is still sufficient pulsation in the flow. All liquids that conduct ultrasound waves can be measured.

Your benefits

- Maximum chemical resistance by the use of PVDF and PTFE
- No electrical conductivity of the medium is needed
- Measurement above stroke volumes of approx. 30 µl
- Detection of gas bubbles in the feed chemical
- No bottlenecks in the measuring tube. Media with small undissolved particles or with increased viscosity can be measured
- A 0/4 -20 mA current output and a frequency output are available for remote transmission of the measured values.
- Use as a single stroke monitor with feedback to the pump. This ensures that the metering stroke is performed within an adjustable lower and upper limit
- Summation of the metering volume measured with stroke counter
- Intuitive user guidance and simple programming

Technical Details

- 2 LEDs for status display and stroke feedback
- 2-line graphic display
- 0/4-20 mA standard signal and 0 – 10 kHz frequency output for remote transmission of the measured value
- Compact, chemically-resistant plastic housing
- Measuring accuracy ± 2 % if the device has been calibrated to the chemical to be measured. Max. operating pressure 16 bar.

Field of application

- Measurement of the chemical consumption, for example in surface treatment.
- Guaranteed metering, for example in the paper industry.
- Measured value transmission and pump control by the central control system.
- Measurement of aggressive chemicals.
- Not suitable for liquids, which have minimal acoustic conductivity, e.g. sodium hydroxide (NaOH) with a concentration of greater than around approx. 20%.
- **We recommend first testing the measurability with emulsions and suspensions.**
- **Media like chlorine dioxide liquids, which can penetrate through PVDF, can lead to shorter lifetime of the transducers.**

Dimensional drawing of DulcoFlow®

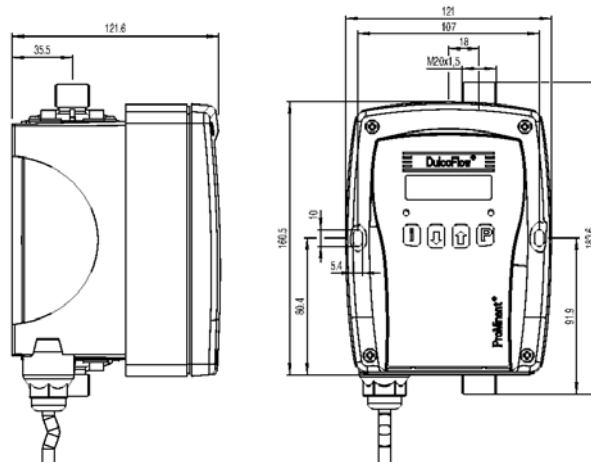

P_DFI_0003_SW_Dulcoflow_SW3
Dimensional drawing of DulcoFlow® - dimensions in mm

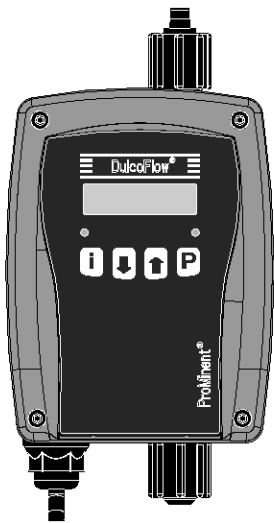

P_DFI_0002_SW1



1.9 Electrical Accessories

Technical Data

Type	Type 08
Measuring tube	PVDF
Max. operating pressure	16 bar
Smallest measurable stroke volume	Approx. 0.05 ml/stroke pulsing
Contact output with individual stroke detection	Open collector, 1 contact per stroke
Frequency output	Open collector, up to 10 kHz at maximum flow (parametrisable)
Analogue output for series	Parametrisable, max. load 400 Ω Beta® 1604 – 0420, gamma/ X 1604 – 0424, delta® 1020 – 0450, Sigma/ 1

Identity code ordering system for DulcoFlow® ultrasound flow meter

DFMa	Type (for pump series)
08	Beta® 1604 – 0420, gamma/ X 1604 – 0424, delta® 1020 – 0450, Sigma/ 1
	Sealant material
	E EPDM
	V FKM
	T PTFE
	Hydraulic connection
	1 6/4 mm
	2 8/5 mm
	3 12/9 mm
	Electrical connection, cable
	A 100 - 230 V AC, 2 m European
	B 100 - 230 V AC, 2 m Swiss
	C 100 - 230 V AC, 2 m Australian
	D 100 - 230 V AC, 2 m USA
	Signal output
	0 No output
	1 Current output
	2 Contact output
	3 Current output and contact output
	4 Current output for delta® with control module
	Version
	0 With ProMinent® logo
	Accessories
	0 Without accessories

Matching adapter, hydraulically mechanical accessories

- Foot Valves see page → 1-46
- Injection Valves see page → 1-49
- Connector Parts, Seals, Hoses see page → 1-75
- Suction Lances/Suction Assemblies see page → 1-64



1.9 Electrical Accessories

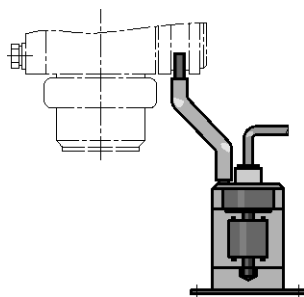

pk_1_087

Diaphragm rupture indicator

Triggers alarm and switches off metering pump in the event of diaphragm rupture. Consists of float switch, PVC/PE, acrylic tank, connectors and connecting hose. Potential-free NO contact, max. contact voltage 60 V AC, 300 mA, 18 W.

	For pump	Order no.
Diaphragm rupture indicator	Meta, Makro TZ	803640
Diaphragm rupture indicator	Makro/ 5	1019528

Siren

HUW 55, 230 V, 50 - 60 Hz,

165 x 60 x 65, 85 phon, indoor.

(e.g. in association with fault indicating relay or relay controller)



pk_1_088

	Order no.
HUW 55 Horn	705002

Warning light

Wall mounted, red, 230 V, 50 - 60 Hz.

(e.g. in association with fault indicating relay, pulse generator or relay controller)

	Order no.
Indicator lamp, red	914780



1.10 Special Accessories

1.10.1 Custom Accessories

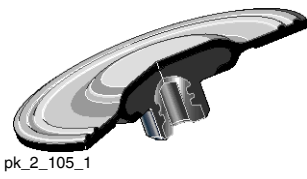

pk_2_105_1

FKM metering diaphragm

As standard diaphragm but made of FKM, and without PTFE coating. Designed specifically for crystallising chemicals, e.g. silicate. Max. operating pressure 6 bar.

For pump type	Order no.
Sigma/ 1 (old diaphragm) 12017, 12035, 10050	1010281
Sigma/ 1 (old diaphragm) 10022, 10044, 07065	1010284
Sigma/ 1 (old diaphragm) 07042, 04084, 04120	1010287
Sigma/ 2 (old diaphragm) 16050, 16090, 16130	1018953
Sigma/ 2 (old diaphragm) 07120, 07220, 04350	1018984
Sigma/ 3 (old diaphragm) 120145, 120190, 120270, 120330	1006564
Sigma/ 3 (old diaphragm) 070410, 070580, 040830, 041030	1006566

Additional custom diaphragms for other pump types are available on request.

FKM = Fluorine Rubber

Liquid end valve springs

With approx. 0.05-0.1 bar priming pressure for spring loading of the valve balls in the liquid end. Recommended to improve the valve function and to increase metering accuracy, in particular for viscous media above 50 m Pas.

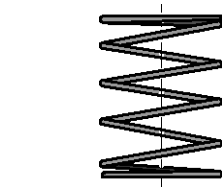

pk_1_103

	Order no.
1.4571 valve spring 0.05 bar for 1/4" connector on Meta/Makro TZ HK	469461
1.4571 valve spring 0.05 bar for 3/8" connector on Makro TZ HK	469462
Hastelloy C valve spring 0.1 bar DN 10	469114
Hastelloy C valve spring 0.1 bar DN 15	469107
Hastelloy C valve spring 0.1 bar DN 20	469451
Hastelloy C valve spring 0.1 bar DN 25	469452

Injection valve springs

With approximately 0.5-1 bar priming pressure for increased metering reproducibility and prevention of suction and siphoning effect.

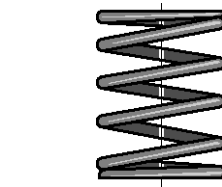

pk_1_104

	Order no.
Hastelloy C valve spring 0.5 bar DN 10	469115
Hastelloy C valve spring 1 bar DN 10	469119
Hastelloy C valve spring 0.5 bar DN 15	469108
Hastelloy C valve spring 1 bar DN 15	469116
Hastelloy C valve spring 0.5 bar DN 20	469409
Hastelloy C valve spring 1 bar DN 20	469135
Hastelloy C valve spring 0.5 bar DN 25	469414
Hastelloy C valve spring 1 bar DN 25	469136
Hastelloy C valve spring 0.5 bar DN 40	469104
Hastelloy C valve spring 1 bar DN 40	469137
Valve spring Hast. C 0.5 bar DN 32	1002799
Valve spring Hast. C 1 bar DN 32	1002805

Injection valve spring with FEP coating

	Order no.
Hastelloy C/FEP valve spring 0.5 bar for DN 10	818515
Hastelloy C/FEP valve spring 0.5 bar for DN 15	818516
Hastelloy C/PVDF valve spring 0.5 bar for DN 20	818517
Hastelloy C/PVDF valve spring 0.5 bar for DN 25	818518
Hastelloy C/PVDF valve spring 0.5 bar for DN 40	818519



1.10 Special Accessories

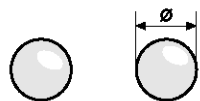

pk_1_102

Custom valve balls

Ball valves and accessories for on site retrofitting of metering pumps when the standard material is unsuitable. Supplied loose only.

	Order no.
PTFE diameter 11.0 for DN 10 valve	404260
PTFE diameter 16.0 for DN 15 valve*	404259
PTFE diameter 20.0 for DN 20 valve	404256
PTFE diameter 25.0 for DN 25 valve	404257
PTFE diameter 38.1 for DN 40 valve	404261
Ceramic diameter 11.1 for DN 10 valve	404277
Ceramic diameter 16.0 for DN 15 valve*	404275
Ceramic diameter 20.0 for DN 20 valve	404273
Ceramic diameter 25.0 for DN 25 valve	404274
Ceramic diameter 38.1 for DN 40 valve	404278

* Not suitable for PVT valve material.

Adapter from DN10-3/4" to M20x1.5

Fits 12 x 9 hose connector set

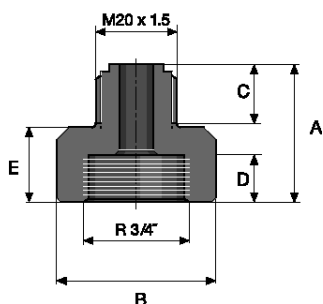

pk_2_058

	Material	Order no.
Adapter from DN 10, 3/4" fem. to M20 x 1.5 male	PVDF	1017406

DN15 adapter, 1" (Sigma) to M20 x 1.5

Fits 12 x 9 tube connector kit.

	Material	Order no.
Adapter from DN 15, 1" fem. to M20 x 1.5 male	PVDF	1028530

Dimensions

	A	B Ø	C	D	E
	mm	mm	mm	mm	mm
Adapter from DN 10, 3/4" fem. to M20 x 1.5 male	35	36	15	12	19
Adapter from DN 15, 1" fem. to M20 x 1.5 male	36	41	15	13	20

Adapter (complete) from M20 x 1.5 to G3/4 DN10

Consisting of an adapter and a PTFE, EPDM/P, FPM-A flat seal and PTFE shaped composite seal. Suitable for connection of the flow meter DulcoFlow® to a Sigma/ 1.

	Material	Order no.
Adapter (complete) from M20 x 1.5 to G3/4 DN10	PVT	1028409

Valve adapter DN 32 - DN 25

Suitable for the liquid end of the Sigma/ 3 metering pump FM 1000 up to 600 l/h.

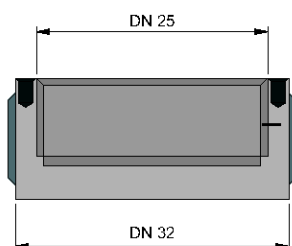

P_AC_0244_SW

	Material version	Material	Order no.
Adapter DN 32 - DN 25	SST	1.4404	1035729
	PVT	PVDF	1035732
	TT	PTFE	1040414



1.10 Special Accessories

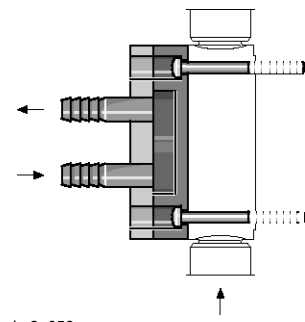

pk_2_059

Cooling/heating equipment, diaphragm metering pumps

For stainless steel liquid end. For assembly, including retrofitting, onto the liquid end. 10 mm diameter connectors for hot/cold chemicals with locking screws. Dimensions in mm. Outer diameter A, pitch circle diameter LK.

Temperature -10 ... 80 °C

For pump	Ø A mm	Ø LK mm	Order no.
Sigma/ 1 FM 50/65*	-	-	1025500
Sigma/ 1 FM 120*	-	-	1025501
Sigma/ 2 FM 130*	-	-	1002178
Sigma/ 2 FM 350*	-	-	1002179
Sigma/ 3 FM 330*	-	-	1006455
Sigma/ 3 FM 1000*	-	-	1006456
Hydro/ 2/3 FMH 025/060	-	-	1024743
Hydro/ 3 FMH 150	-	-	1040112
Hydro/ 4 FMH 400	-	-	1047700
Meta, Makro TZ FM 130, FM 260	145	127	803751
Meta, Makro TZ FM 530	180	164	803752
Makro TZ FM 1500/2100	248	219	806005
Makro/ 5 FM 4000	-	-	1020683
Makro TZ FMH 70/20	-	-	1041263
Makro/ 5 FMH 85/50	-	-	1041261
Makro/ 5 FMH 60/50	-	-	1041260
Makro/ 5 FMH 130/50	-	-	1041262

* Adapted to the design with the new multi-layer safety diaphragm.

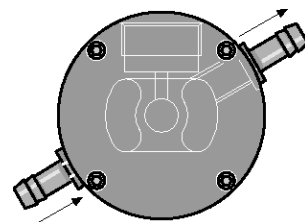

pk_2_064

Cooling/heating equipment, plunger metering pumps

The cooling/heating equipment is installed in the liquid end. 10 mm diameter connectors. Cannot be retrofitted.

For pump	Order no.
Sigma HK - 08 S	1040459
Meta/Sigma HK - 12.5 S	803551
Meta/Sigma HK - 25 S	803552
Meta/Sigma HK - 50 S	803553
Makro TZ FK 30	1036645
Makro TZ FK 50	1036655
Makro TZ FK 85	1024665

Cooling/heating equipment for Makro TZ HK on request.



1.11 Application Examples

1.11.1 Metering of Highly Viscous Substances

Product: **Motor-driven pumps**
 Metered medium: **Viscous filler**
 Sector: **Electronics**
 Application: **Part filling**

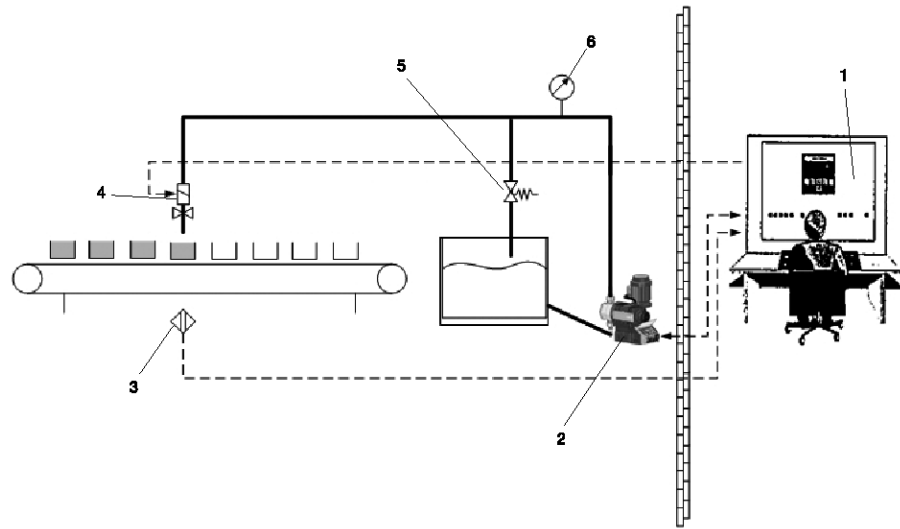

- 1 Process control system (master)
- 2 Metering pump, Sigma (field unit)
- 3 Proximity switch
- 4 Solenoid valve
- 5 Overflow valve
- 6 Pressure gauge

pk_2_113

Tasks and requirements

- Metering of a viscous filler in templates
- Metering accuracy $\pm 2\%$
- Varying filling volumes

Operating conditions

- The templates pass the metering point on a conveyor in „stop and go“ operation.
- The pump is started by a proximity switch at the conveyor (external contact control).

Notes on application

- The start always begins with a pressure stroke, i.e. controlled stop of the diaphragm at the end of the suction stroke.
- When varying the filling volume, a stroke length as large as possible should be chosen - this improves accuracy.
- Short and stable suction and metering lines, no pulsation damper - thus reduction of the flexible (moved) volume.
- If possible work with feed so that the suction lines are always filled with liquid even during longer idle times.
- A solenoid valve is required for filling to prevent dripping of the residual quantities.

Solution

- Sigma Control metering pump with PROFIBUS® connection
- Overflow valve, solenoid valve

Benefit

- Monitoring of the metering pump and setting of the metering amount (number of strokes) by PCS in the control centre
- Less electrical installation work required
- Integration into the complete process flow through PROFIBUS®
- Safe and precise metering thanks to overflow and solenoid valves



1.11 Application Examples

1.11.2 Mixing Two Reagents

Product: **Motor-driven pumps, solenoid-driven pumps**
 Metered medium: **Chlorine activator, oxidant (NaOCl)**
 Sector: **Process industry, power stations**
 Application: **Biocide handling in cooling water systems**

- 1 Static mixer
- 2 Flow Control
- 3 Feed measuring unit
- 4 NaOCl solution
- 5 Chlorine activator
- 6 Feed measuring unit
- 7 Motive water
- 8 Flow Control
- 9 Flow rate measurement
- 10 Control cabinet
- 11 Reaction chamber

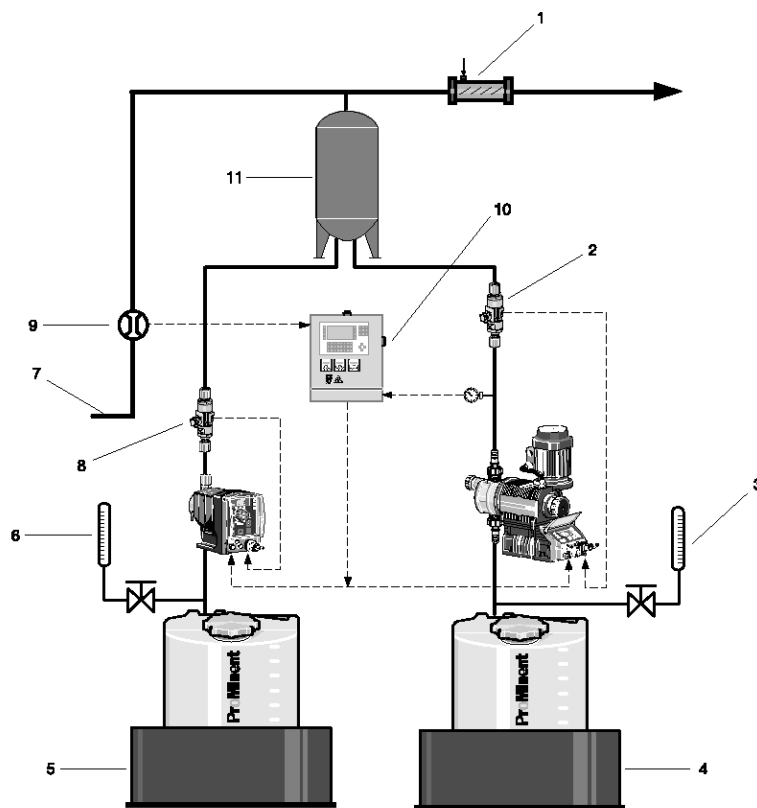

pk_2_114_1

Tasks and requirements

- Biocide treatment of cooling water systems used in combination with chlorination processes.
- Chlorine activator is mixed with NaOCl to produce hypobromous acid (HOBr) as an active biocide compound. HOBr is particularly effective at pH values from 7.5 to 9.0.
- A level of 0.5 g/m³ of active HOBr over a period of 1 hour is to be secured twice a day for the purpose of disinfecting the cooling water.

Operating conditions

- Biologically polluted water
- Automatic activation of metering pumps

Application information

- The mixing ratio of chlorine activator and NaOCl (12.5 % solution) is 10 l to 26 – 52 l. The exact composition is to be determined by means of tests (on site).
- Metering pump with timer function activates the second pump and is therefore responsible for batch metering.
- Motor-driven pump is protected against overload by a pressure gauge with pressure switch. The pressure gauge is connected to the control system.
- The control system monitors the installation and switches off the flow meter in response to corresponding signals (fault signalling).



1.11 Application Examples

Solution

- gamma/ L metering pump with timer function (possibly with external timer)
- Sigma/ 1 metering pump, control version
- Feed monitoring, flow control
- Feed measuring facility
- Pressure gauge with pressure switch

Benefits

- Efficient disinfection in water containing alkali and ammoniac
- Inexpensive raw material basis that is also stable and non-corrosive
- High degree of reliability ensured by flow monitoring
- Simple and effective facility for optimising the chemical composition in connection with feed measuring device



1.11 Application Examples

1.11.3

Safe and Reliable Chemical Metering with Reduced Pulsation

Product: **Metering pump, accessories**
 Metered medium: **High viscosity chemicals**
 Application: **Use of pulsation damper (PD)**

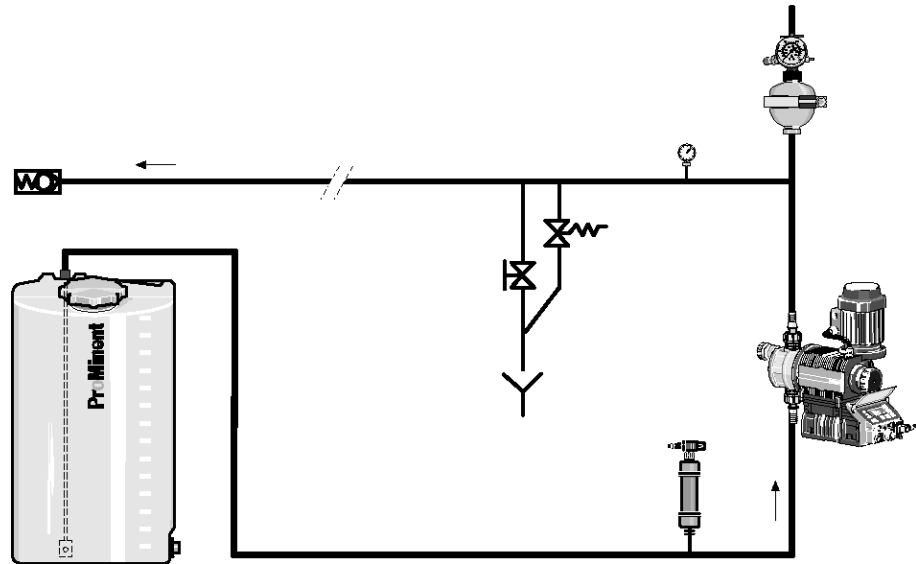

pk_2_117

Tasks and requirements

- For process-technical reasons, a low-pulsation metering flow is desired.
- Mass accelerating forces during metering, caused by the oscillating movement of the displacement body in connection with the piping geometry need to be reduced.
- Cavitation-free process flow

Operating conditions/environment

- Long suction/discharge lines
- Line cross-section with small dimensions
- Metering of high-viscosity, inert media

Notes on application

- Pressure surges increase with increasing metering line length and smaller diameter; these may result in impermissible pressure peaks.
- For longer pipes, as well as for higher viscosity media, the need for a PD using a pipe calculation programme is to be evaluated.
- In an oscillating motor-driven metering pump, the maximum flow rate is approx. 3 times greater than the mean, in a solenoid-driven pump approx. 5 times as great. This is to be considered when designing pipings without PD.
- PD should be preloaded with compressed air or nitrogen at approx. 60-80% of the operating pressure to be expected.

Solution

- ProMinent® metering pumps
- Pressure-relief/overflow valves
- Pulsation dampers

Benefits

- Safe installation preventing damage to pumps and pipes
- Precise metering by avoiding of cavitation
- Compensation of delivery flow fluctuations



1.11 Application Examples

1



2.0 Overview of Process Metering Pumps

2.0.1 Selection Guide

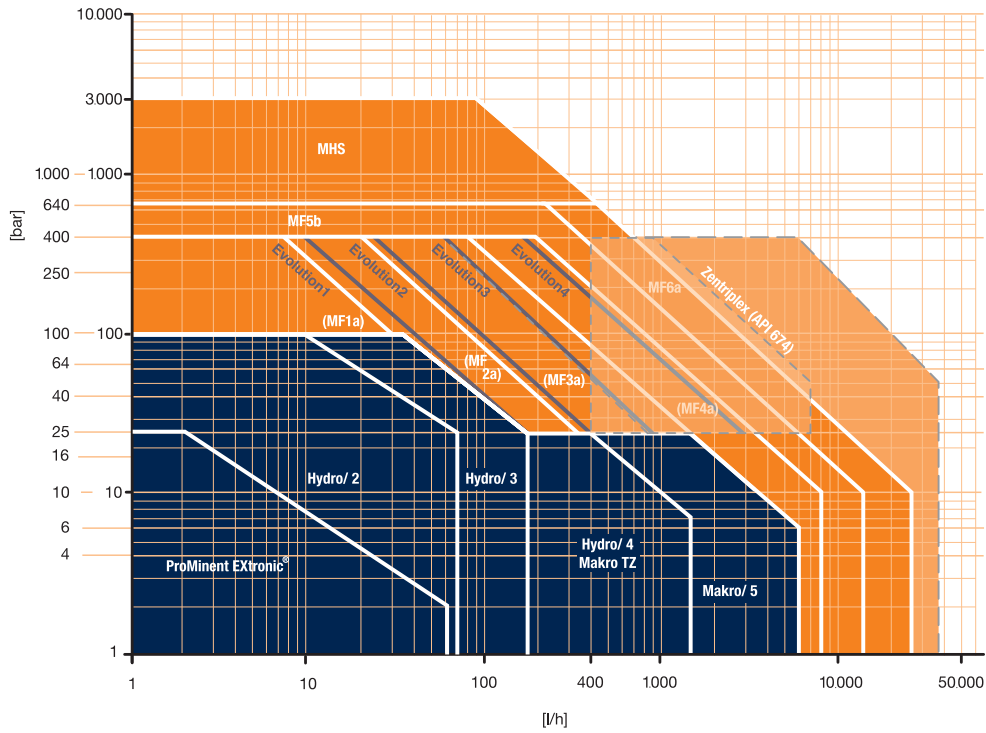

S43

Overview of Process Metering Pumps

Type		EXBb	TZMb	M5Ma	HP2a	HP3a	HP4a	M5Ha	SBKa/ SCKa	MTKa	TZKa	M5Ka
Stroke length	mm	1.25	0 - 10	0 - 20	15	15	20	0 - 50	0 - 15	0 - 15	0 - 20	0 - 50
Connecting rod force	N	2,000	8,000	10,000	2,000	4,200	5,800	10,000	1,700	2,500	8,000	10,000

Type		EF1a	EF2a	EF3a	EF4a	EP1a	EP2a
Stroke length	mm	0 - 15	0 - 15	0 - 25	0 - 40	0 - 15	0 - 15
Connecting rod force	N	2,300	5,400	8,000	15,700	2,300	5,400

Type		S 18	S 35	S 80	S 180	S 600	S 1400	Rb 15	Rb 150	Zentriplex
Stroke length	mm	0 - 15	0 - 20	0 - 20	0 - 40	0 - 40	0 - 60	0 - 15	0 - 32	40
Connecting rod force	N	1,750	3,500	14,000	18,000	40,000	60,000	1,800	15,000	18,000



2.0 Overview of Process Metering Pumps

2.0.2 Installation Applications

- | | |
|---|---|
| A Oil Industry | B Gas Industry |
| A1 Well | B1 Well |
| A2 Platform | B2 Gas treatment/gas drying |
| A3 Transportation (tanker, pipeline) | B3 Transportation (tanker, pipeline) |
| A4 Refinery | B4 Gas storage tank |
| A5 Petrochemical | B5 Local distribution/odorization |
| A6 Industry/power plants | B6 Industry/power plants |
| A7 Filling stations | |

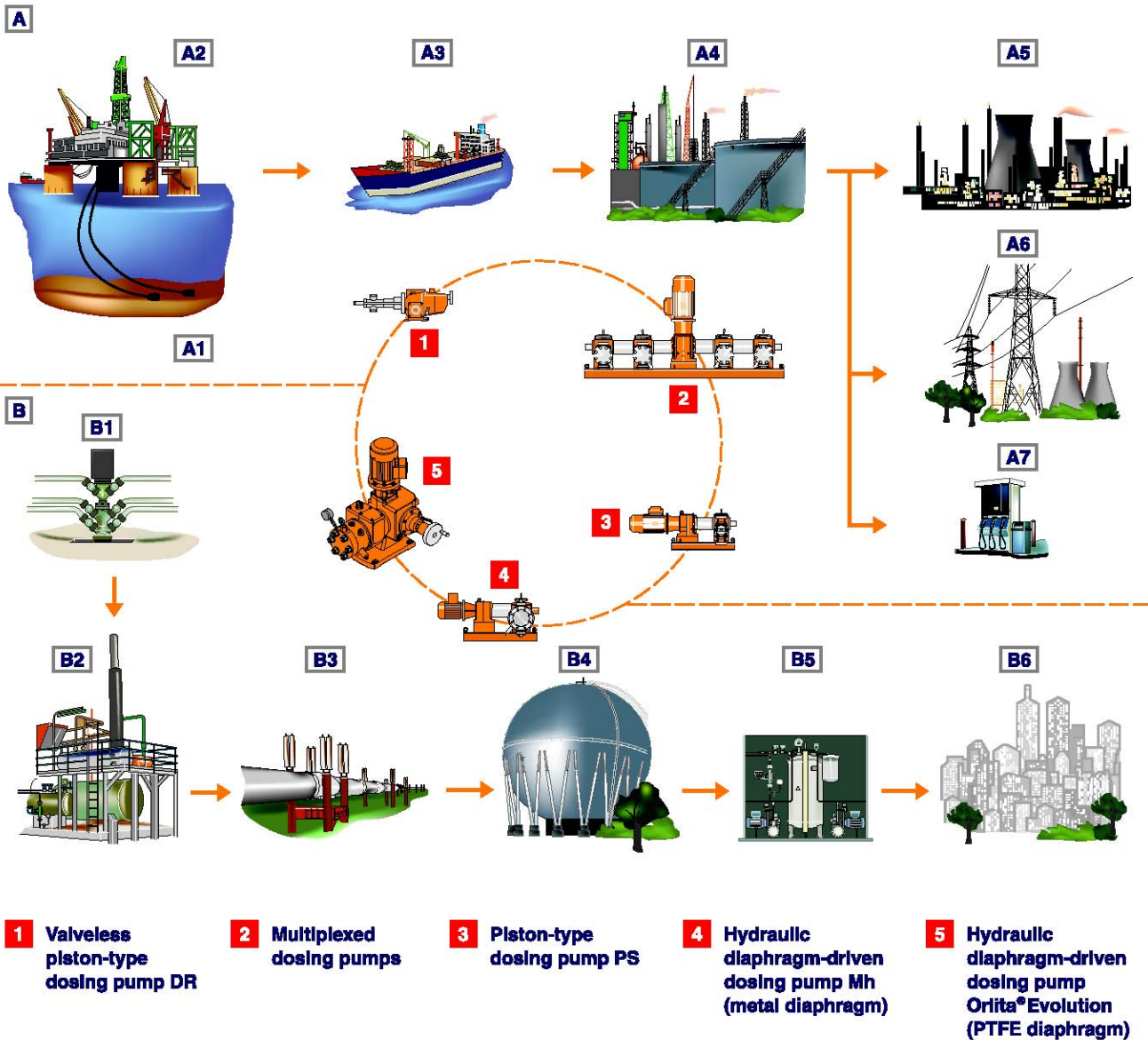

pk_3_07



2.1 Diaphragm Metering Pump ProMinent EXtronic®

2.1.1 Diaphragm Metering Pump ProMinent EXtronic®



Precise metering with explosion protection

Capacity range of single pump: 0.19 – 60 l/h, 10 – 1.5 bar

The diaphragm metering pump EXtronic® is perfectly suited for the sensitive use of liquid media in facilities with an explosive gas atmosphere as well as for mines at risk of firedamp, as it is approved in compliance with the EC EX Regulation 94/9/EC (ATEX).

The ATEX-compliant diaphragm metering pump EXtronic® (EXBb) is tested and approved in line with the harmonised EC provisions of EN 50014/50018 for "compression-resistant enclosures" and thus offers the maximum level of protection. The short-stroke solenoid and the complete pump control are integrated in the pump housing so that, together with the explosion-proof power end, there is IP 65 protection against contact and humidity as per DIN 40050 even when the front cover is open.

Your benefits

Optimum adaptation for use in areas at risk from explosion

- ATEX-compliant in line with EExd IIC T6 and EExd I/IIC T6
- Excellent operating and functional reliability by a microprocessor controller, which compensates for fluctuations of mains voltage and automatically switches from 50 to 60 Hz operation
- Broad range of applications with an operating voltage of 500 V, 230 V and 115 V
- Ease of integration into processes thanks to the range of control types (internal, external contact, analogue)
- Also suitable for gaseous media, thanks to self-bleeding head

Technical Details

- Stroke length: 1.25 mm, Rod force: 2,000 N
- Stroke length adjustment range: 0 – 100% in operation and idle
- Stroke length adjustment: manually by scaled rotary dial
- Metering reproducibility is better than ± 2% within the 30 – 100% stroke length range under defined conditions and with correct installation. Observe the information in the operating instructions
- DEVELOPAN® metering diaphragm with PTFE coating with diaphragm rupture control
- Wetted materials: Polypropylene, PVC, PTFE with carbon, clear acrylic, stainless steel, special designs available on request
- Degree of protection: IP 65 (also with open front cover)
- Short stroke solenoid drive and complete pump control integrated in the pump housing
- "Internal", "External contact" and "Analogue" control inputs available, the latter two also available as intrinsically safe and approved to EN 50020

- EXBb G for use in areas at risk from gases and vapours, degree of protection EEx [i,a] d IIC T6

This means:

- EEx - Equipment complies with European standards
- [i,a] - Control input is intrinsically safe when 2 independent errors occur
- d - Type of ignition protection, compression-resistant enclosure
- IIC - Explosion group II for all areas at risk from explosion with the exception of mining, sub-group IIC (includes IIA and IIB)
- T6 - Temperature class permissible for gases and vapours with ignition temperature > 85 °C

- EXBb M for use in mines at risk from firedamp, degree of protection EEx [i,a] d I/IIC T6

This means:

- EEx - Equipment complies with European standards
- [i,a] - Control input is intrinsically safe when 2 independent errors occur
- d - Type of ignition protection, compression-resistant enclosure
- IC - Explosion group I for mines at risk from firedamp
- IIC - Explosion group II for all areas at risk from explosion with the exception of mining, sub-group IIC (includes IIA and IIB)
- T6 - Temperature class permissible for gases and vapours with ignition temperature > 85 °C

Field of application

- Oil, gas and petrochemicals
- Mining
- For use in areas at risk of gases and vapours
- Use in mines at risk from firedamp

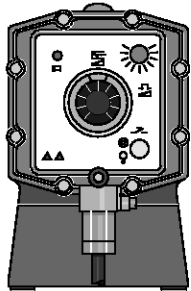

pk_1_020

Control type "Internal"

Stroke length adjustment 1:10, stroke rate adjustment 1:25, total adjustment range 1:250.

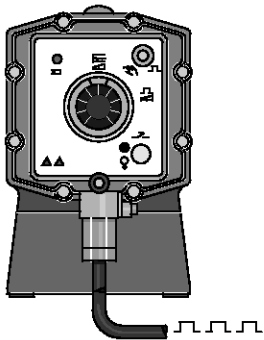

pk_1_019

Control type "External Contact"

Stroke length adjustment 1:10, Stroke frequency control 0 - 100% dependant upon external switch contacts. *)

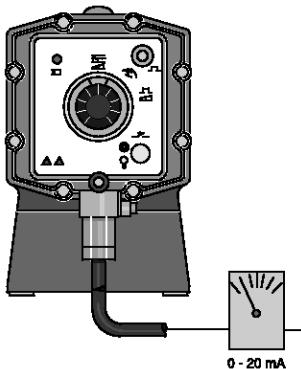

pk_1_018

Control type "Analogue"

Stroke length adjustment 1:10, Stroke frequency control 0-100 % proportional to analogue signal 0/4-20 mA. *)

*) The electrical cables for mains connection, contact or analogue control are already connected to the pump. Observe all instructions concerning connecting and activating electrical systems.



2.1 Diaphragm Metering Pump ProMinent EXtronic®

Technical Data

Type EXBb	Delivery rate at max. back pressure			Delivery rate at medium back pressure			Stroke rate Strokes/min	oØ x iØ mm	Suction lift m WC	Shipping weight PP,NP,TT-SS kg
	bar	l/h	ml/stroke	bar	l/h	ml/stroke				
EXBb										
1000	10	0.19	0.03	5	0.27	0.04	120	6 x 4	1.5	12
2501	25	1.14	0.15	20	1.10	0.17	120	6 x 4	5.0	-
1601	16	1.00	0.15	8	1.30	0.18	120	6 x 4	5.0	12
1201	12	1.70	0.23	6	2.00	0.28	120	6 x 4	5.0	12
0803	8	3.70	0.51	4	3.90	0.54	120	6 x 4	3.0	12
1002	10	2.30	0.31	5	2.70	0.38	120	8 x 5	5.0	12
0308	3	8.60	1.20	1	10.30	1.43	120	8 x 5	5.0	12
2502	25	2.00	0.28	20	2.20	0.31	120	8 x 5	5.0	13
1006	10	6.00	0.83	5	7.20	1.00	120	8 x 5	5.0	13
0613	6	13.10	1.82	3	14.90	2.07	120	8 x 5	5.5	13
0417	3	17.40	2.42	2	17.90	2.49	120	12 x 9	4.5	13
2505	25	4.20	0.64	20	4.80	0.73	110	8 x 5	5.0	16
1310	13	10.50	1.59	6	11.90	1.80	110	8 x 5	5.0	16
0814	8	14.00	2.12	4	15.40	2.33	110	12 x 9	5.0	16
0430	3	27.00	4.09	2	29.50	4.47	110	DN 10	5.0	16
0260	1	60.00	9.09	-	-	-	110	DN 15	1.5	16
EXtronic® metering pumps for high viscosity media										
1002	10	2.30	0.31	5	2.70	0.38	120	DN 10	1.8	-
1006	10	6.00	0.83	5	7.20	1.00	120	DN 10	2.0	-
1310	10	10.50	1.59	5	11.90	1.80	110	DN 15	2.8	-
0814	8	14.00	2.12	4	15.40	2.33	110	DN 15	2.0	-
EXtronic® metering pumps with self-bleeding liquid end										
1601	16	0.66	0.09	-	-	-	120	6 x 4	1.8	-
1201	12	1.00	0.14	-	-	-	120	6 x 4	2.0	-
0803	8	2.40	0.33	-	-	-	120	6 x 4	2.8	-
1002	10	1.80	0.25	-	-	-	120	6 x 4	2.0	-

* Shipping weight for EXBb M version... additional 14 kg

** The data given here represent guaranteed minimum values, achieved with medium water at room temperature.

Materials in Contact With the Medium

	Liquid end	Suction/discharge connector	Seals	Balls (connection 6-12 mm)	Balls (connection DN 10 and DN 15)
PP1	Polypropylene	Polypropylene	EPDM	Ceramic	Borosilicate glass
PP4*	Polypropylene	Polypropylene	EPDM	-	Ceramic
NP1	Plexiglass	PVC	FKM A	Ceramic	Borosilicate glass
NP3	Plexiglass	PVC	FKM B	Ceramic	-
NS3**	Plexiglass	PVC	FKM B	Ceramic	-
PS3**	PVC	PVC	FKM B	Ceramic	-
TT1	PTFE with carbon	PTFE with carbon	PTFE	Ceramic	Ceramic
SS ..	Stainless steel mat. no. 1.4404	Stainless steel mat. no. 1.4404	PTFE	Ceramic	Stainless steel mat. no. 1.4404

* PP4 with valve springs made of Hastelloy C

** NS3 and PS3 with valve springs made of Hastelloy C, valve insert made of PVDF
FKM = fluorine rubber



2.1 Diaphragm Metering Pump ProMinent EXtronic®

2.1.2 Identity Code Ordering System for EXBb

EXBb	Enclosure rating		
G	Gas-EX-proof		
M	Fire and explosion protection, permitted liquid end material: stainless steel and PTFE		
Capacity			
	bar	l/h	
1000	10	0.19	
2501	25	1.14	(only available in SS and SB)
1601	16	1.00	
1201	12	1.70	
0803	8	3.70	
1002	10	2.30	
0308	3	8.60	
2502	25	2.00	(available in SS and SB only)
1006	10	6.00	
0613	6	13.10	
0417	4	17.40	
2505	25	4.20	(only available in SS and SB)
1310	13	10.50	(only available in NP, PP4, SS and SB)
0814	8	14.00	
0430	4	27.00	
0260	2	60.00	
Liquid end material			
PP1	Polypropylene with EPDM O-ring		
PP4	HV Polypropylene for high viscosity liquids with EPDM O-ring and Hastelloy C valve springs (Types 1002, 1006, 1310 and 0814 only)		
NP1	Acrylic with FKM A O-ring*		
NP3	Acrylic with FKM B O-ring*		
NS3	Acrylic with FKM B O-ring*, self bleeding (Types 1601, 1201, 0803 and 1002 only)		
PS3	PVC with FKM B O-ring*, self bleeding (Types 1601, 1201, 0803 and 1002 only)		
TT1	PTFE with carbon, PTFE seal		
SS1	Stainless steel, no. 1.4404, with PTFE seal		
SS2	Stainless steel with 1/4" NPT internal thread, PTFE seal		
SB1	Stainless steel with ISO 7 Rp 1/4 internal thread, ISO 7 Rp 1/2 on type 0260, PTFE seal (recommended for flammable materials)		
SSM	as SS1, with diaphragm rupture indicator Type 2501 only		
SBM	as SB1, with diaphragm rupture indicator Type 2501 only		
Valve springs			
0	No springs		
1	With 2 valve springs, 1.4571, 0.1 bar		
Electrical connection			
A	230 V, 50/60 Hz		
B	115 V, 50/60 Hz		
E	500 V, 50/60 Hz		
Control type			
0	Manual stroke rate adjustment via potentiometer		
1	External contact		
2	Analogue 0-20 mA		
3	Analogue 4-20 mA		
4	External contact, intrinsically safe [i,a]		
5	Analogue 0-20 mA, intrinsically safe [i,a]		
6	Analogue 4-20 mA, intrinsically safe [i,a]		
7	Manual with zero volts ON/OFF		
8	Manual with zero volts ON/OFF, intrinsically safe [i,a]		
Control Versions			
0	With potentiometer (control type 0, 7 and 8 only)		
1	With manual auxiliary key for maximum stroke rate (control type 1-6 only)		
2	With manual auxiliary frequency changer key for maximum stroke rate (control type 1-6 only)		
Approved/Language			
0	BVS - Europe, German, 100 V - 500 V		
1	BVS - Europe, English, 100 V - 500 V		
2	FM - USA, English, 115 V		
3	CSA - Canada, English, 115 V, 230 V		

* FKM = Fluorine rubber

2.1 Diaphragm Metering Pump ProMinent EXtronic®

Design of connectors

With PP, NP, NS, PS and TT	6, 8 and 12 mm	Hose nozzle with clamping ring
With stainless steel SS1/SSM	6, 8 and 12 mm	Swagelok system threaded connector
With stainless steel SS2	6, 8 and 12 mm	Internal thread 1/4" NPT
With stainless steel SS1/SBM	6, 8 and 12 mm	Internal thread ISO 7 Rp 1/4
With PP and NP	DN 10 and DN 15	Hose nozzle d 16 - DN 10 and d 20 - DN 15
With TT	DN 10 and DN 15	Welding sleeve d 16 - DN 10 and d 20 - DN 15 (PVDF)
With stainless steel SS1	DN 10 and DN 15	Insert with internal thread R 3/80 and R 1/2"
With stainless steel SB1	DN 10 and DN 15	Internal thread ISO 7 Rp 1/4 and 1/2

Repeatability of metering $\pm 2\%$ when performed in line with the information in the operating instructions.

For type 1601 with self-bleeding dosing head $\pm 5\%$.

Permissible ambient temperature: $-20\text{ }^{\circ}\text{C}$ to $+45\text{ }^{\circ}\text{C}$.

Electrical connection:	500 V $\pm 6\%$, 50/60 Hz
	230 V $\pm 10\%$, 50/60 Hz
	115 V $\pm 10\%$, 50/60 Hz

Degree of protection:	IP 65, insulation class F
------------------------------	---------------------------

Average power consumption at max. stroke rate (W)/peak current during metering stroke (A) at 230 V, 50/60 Hz

EXBb	Type 1000, 2501, 1601, 1201, 0803, 1002, 0308	13 W/0.8 A	at 120 strokes/min.
EXBb	Type 2502, 1006, 0613, 0417	35 W/1.8 A	at 120 strokes/min.
EXBb	Type 2505, 1310, 1014, 0430, 0260	45 W/2.2 A	at 110 strokes/min.

Scope of delivery: Metering pump with mains cable (5 m) and connector parts for hose/pipe connection as per the table.

2.1.3 Spare Parts

Spare Parts Kits for Diaphragm Metering Pump ProMinent EXtronic®

Scope of delivery with material versions PP and NP:

- 1 Diaphragm
- 1 Suction valve, complete
- 1 Discharge valve, complete
- 2 Valve balls
- 1 Sealing set, complete
- 1 Connector kit

Scope of delivery with material versions NS3 and PS3:

- 1 Diaphragm
- 1 Suction valve, complete
- 1 Connector component, complete
- 1 Discharge valve, complete
- 1 Bleed valve, complete
- 1 Connector kit

Scope of delivery with material version TT-PTFE:

- 1 Diaphragm
- 1 Suction valve, complete
- 1 Discharge valve, complete
- 2 Valve balls
- 2 Ball seat discs
- 1 Sealing set, complete
- 1 Connector kit

Scope of delivery with SS stainless steel material version:

- 1 Diaphragm
- 4 Valve balls
- 4 Ball seat discs
- 1 Sealing set, complete
- 1 Connector kit





2.1 Diaphragm Metering Pump ProMinent EXtronic®

Pump type	Materials in contact with the medium	Order no.	
EXBb 1000	PP1	740357	
	NP3	740354	
	TT	910776	
	SS/SK	910777	
EXBb 2501	SBM	1020281	
	SSM	1020282	
EXBb 1601	PP1	740361	
	NP3	740358	
	NS3/PS3	792033	
	TT	910778	
EXBb 1201	SS/SK	910779	
	PP1	740380	
	NP3	740362	
	NS3/PS3	792034	
EXBb 0803	TT	910780	
	SS/SK	910781	
	PP1	740384	
	NP3	740381	
EXBb 1002/2502	NS3/PS3	792035	
	TT	910782	
	SS	910783	
	PP1	740388	
EXBb 0308/1006/2505	NP3	740385	
	NS3/PS3	792036	
	TT	910784	
	SS	910785	
	HV/PP 4	Type 1002	910743
EXBb 0613/1310	PP1	740497	
	NP1	740498	
	TT	910957	
	SS	910959	
EXBb 0417/0814	HV/PP4	Type 1006	910939
	PP1	740504	
	NP1	740505	
	TT	910969	
EXBb 0430-DN 10	SS	910971	
	HV/PP4	Type 1310	910941
	PP1	740501	
	NP1	740502	
EXBb 0430-DN 10	TT	910977	
	SS	910979	
	HV/PP4	Type 0814	910943
	PP1	740507	
EXBb 0430-DN 10	NP1	740508	
	TT	910993	
	SS	910995	

Replacement parts set as DN 10 with one-way ball valves.

2.1 Diaphragm Metering Pump ProMinent EXtronic®

Spare Diaphragms for Diaphragm Metering Pump ProMinent EXtronic®

ProMinent® DEVELOPAN® EPDM metering diaphragms with woven inner layer, integrally vulcanised steel core and PTFE Teflon coating on the side in contact with the feed chemical.



pk_1_008

For pump type	Description	Order no.
1000	31.0 x 6.0	811452
2501	35.0 x 11.5	1000246
1601	48.0 x 9.5	811453
1201	48.0 x 12.5	811454
0803	48.0 x 18.5	811455
1002, 2502	60.0 x 17.0	811456
0308, 2505, 1006	60.0 x 28.0	811457
1310, 0613	76.0 x 37.0	811458
0814, 0417	76.0 x 45.0	811459
0430, 0230	127.5 x 63.0	811460
0260	127.5 x 91.0	811461

2.1.4 Ex-Proof Ancillary Equipment

Plastic terminal box: Type I

IP 66, EEx e II T 6, max. 380 V for mains connection, e.g. of ProMinent EXtronic® in areas at risk of explosion.

Order no.

1 input, 1 output for power supply cable. 2 terminals + PE and 2 M 20-12 screw glands

1000071

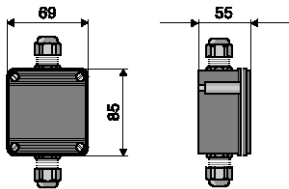

pk_1_023

Plastic terminal box: Type II

IP 66, EEx e II T 6, max. 380 V. As type I, but with additional connector for control cable (e.g. for contact water meter or DULCOMETER® controller).

Order no.

2 inputs (mains and controller cable), 2 outputs
2 terminals + PE, 1 partition, 2 terminals and
2 M 20-12 screw glands and
2 M 16-0.8 screw glands

1000072

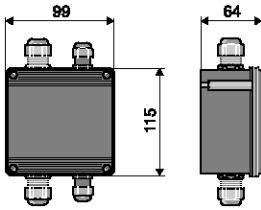

pk_1_021

Plastic terminal box: EExi Type I

IP 66, EEx ia II T 6 for intrinsically safe control cable

Order no.

1 input, 1 output for control cable, 2 terminals and 2 M 16-0.8, blue screw glands

1000073

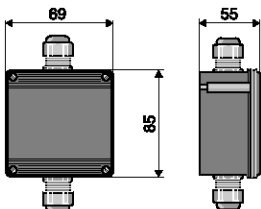

pk_1_022

2.1 Diaphragm Metering Pump ProMinent EXtronic®

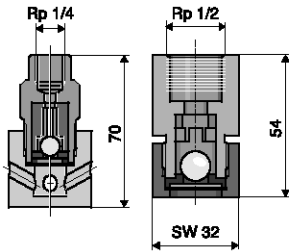

pk_1_30 / pk_1_031

Stainless steel foot valve 1.4404 "SB"

With filter and ball check valve, designed for use with flammable materials. Materials: 1.4404/1.4401/PTFE/ceramic

	Order no.
Connector ISO 7 Rp 1/4 SB version for ProMinent EXtronic®	809301
Connector ISO 7 Rp 1/2 SB version for ProMinent EXtronic®	924561

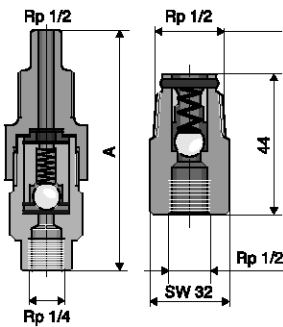

pk_1_032_2 / pk_1_027

Stainless steel 1.4404 "SB" metering valve

Spring-loaded ball check valve designed for use with flammable materials. Materials: 1.4404/1.4401/Hastelloy C/PTFE/ceramic

	Order no.
Connector ISO 7 Rp 1/4 - R 1/2, priming pressure approx. 0.5 bar	809302
Connector ISO 7 Rp 1/2 - R 1/2, priming pressure approx. 0.5 bar	924560

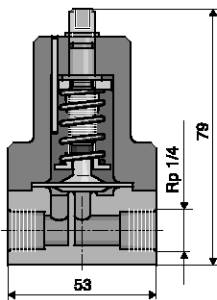

pk_1_029

Adjustable "SB" back pressure valve

	Order no.
Operating range approx. 1-10 bar, closed version, designed for use with flammable materials.	924555

To generate a constant back pressure for accurate metering with a free outlet. Can also be used as an overflow valve.

PTFE metering pipe

Carbon-filled, surface resistance <math> < 10^7 \Omega </math>

Material	Length	Connection size o Ø x i Ø	Permissible pressure bar	Order no.
	m			
Carbon-filled PTFE	By the metre	6 x 4	12*	1024831
Carbon-filled PTFE	By the metre	8 x 5	16*	1024830
Carbon-filled PTFE	By the metre	12 x 9	9*	1024832

* Permissible operating pressure at 20 °C in accordance with EN ISO 7751, ¼ of the rupture pressure, assuming chemical resistance and correct connection.

Additional ancillary equipment, i.e. foot valves, metering valves and back pressure valves in the usual material combinations, identical to gamma ancillary equipment and/or for connector DN 15 Vario ancillary equipment.

(Hydraulic/Mechanical Accessories see p. → 1-46)



2.1 Diaphragm Metering Pump ProMinent EXtronic®



pk_1_028

Stainless steel straight threaded connectors

Swagelok system in stainless steel SS 316 (1.4401) for connection of pipework to liquid ends and valves with internal thread and for SB version.

Normal threaded seal compounds required.

	Order no.
6 mm - ISO 7 R 1/4	359526
8 mm - ISO 7 R 1/4	359527
12 mm - ISO 7 R 1/4	359528
16 mm - ISO 7 R 1/2	359529



2.2 Diaphragm Metering Pump Makro TZ

2.2.1

Diaphragm Metering Pump Makro TZ

Capacity range of single pump: 260 – 2,100 l/h, 12 – 4 bar

Greater safety in continuous operation through mechanically deflected multi-layer safety diaphragm.

The modular construction of the diaphragm metering pump Makro TZ with adjustable eccentric drive mechanism and mechanically deflected multi-layer safety diaphragm makes it wonderfully adaptable to the capacity requirements of the respective application.



The diaphragm metering pump Makro TZ (TZMb) has an adjustable eccentric drive mechanism and, together with the Makro TZ plunger metering pump, forms a range of drive mechanisms with stroke lengths of 10 and/or 20 mm. This covers the capacity range from 8 to 2,100 l/h at 320 – 4 bar. A wide range of drive versions is available, including some for use in Exe and Exde areas with ATEX certification.

Your benefits

Excellent process safety and reliability:

- Patented multi-layer safety diaphragm with integral diaphragm rupture warning system
- Metering reproducibility is better than $\pm 2\%$ within the 30 – 100% stroke length range under defined conditions and with correct installation

Excellent flexibility:

- The modular construction with single and double head versions permits a wide range of applications, with the double head designs being operated in push-pull mode
- It is possible to combine up to 4 metering units, even with different pump capacities, in multiple pump systems
- 5 different gear ratios are available
- Customised designs are available on request

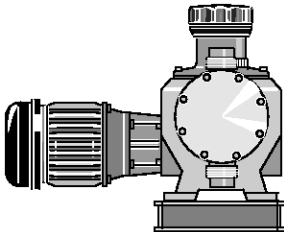
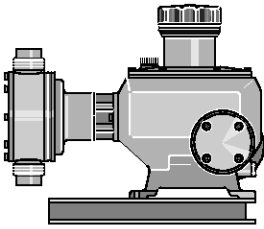

pk_2_012
Makro TZ TZMb

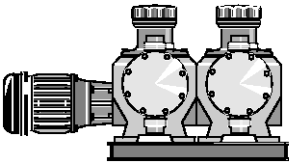

pk_2_013
Makro TZ externally mounted pump

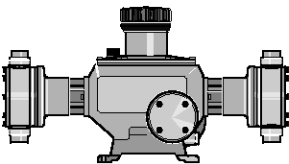

pk_2_014
Makro TZ double head pump

Technical Details

- Stroke length: 0-10 mm, Rod force: 8,000 N
- Stroke length adjustment range: 0 – 100%
- Stroke length adjustment: manually by scaled rotary dial in 0.5% increments (optionally with electric actuator or control drive)
- Metering reproducibility is better than $\pm 2\%$ within the 30 – 100% stroke length range under defined conditions and with correct installation. Observe the information in the operating instructions
- Patented multi-layer safety diaphragm with optical diaphragm rupture display (optionally with electrical diaphragm rupture warning system / warning via a contact)
- Wetted materials: Polypropylene, PVC, PTFE+25% carbon, stainless steel 1.4571. Special materials are available on request
- A wide range of power end versions is available: three-phase standard or 1-phase AC motor, motors for use in Exe and Exde areas, different flange designs for use in customer-specific motors
- Degree of protection: IP 55
- Salt water-resistant, acrylic resin-coated cast aluminium housing
- For reasons of safety, provide suitable overload protection mechanisms in all mechanically deflected diaphragm metering pumps

Field of application

- Volume-proportional metering of chemicals/additives in water treatment
- Metering of reactants and catalysts in the chemical industry
- Level-dependent metering of additives in industrial production engineering



2.2 Diaphragm Metering Pump Makro TZ

Technical Data

Type TZMb	With 1500 rpm motor at 50 Hz				With 1800 rpm motor at 60 Hz				Suction lift m WC	Connection, suction/ discharge side G-DN	Shipping weight PP,NP,TT-SS kg
	Delivery rate at max. back pressure		Max. stroke rate Strokes/ min	Delivery rate at max. back pressure		Max. stroke rate Strokes/ min					
bar	l/h	ml/ stroke		psi	l/h		gph (US)				
120260	12	260	60	72	174	312	82	86	4.0	1 1/2-25	46/54
120340	12	340	60	96	174	408	108	115	4.0	1 1/2-25	46/54
120430	12	430	60	120	174	516	136	144	4.0	1 1/2-25	46/54
120510	12	510	60	144	174	622	164	173	4.0	1 1/2-25	46/54
120650	12	640	60	180	174	-	-	-	4.0	1 1/2-25	46/54
070430	7	430	99	72	100	516	136	86	3.5	2-32	50/64
070570	7	570	99	96	100	684	181	115	3.5	2-32	50/64
070720	7	720	99	120	100	864	228	144	3.5	2-32	50/64
070860	7	860	99	144	100	1,032	273	173	3.5	2-32	50/64
071070	7	1,070	99	180	100	-	-	-	3.5	2-32	50/64
040840	4	840	194	72	58	1,008	266	86	3.0	2 1/4-40	56/80
041100	4	1,100	194	96	58	1,320	349	115	3.0	2 1/4-40	56/80
041400	4	1,400	194	120	58	1,680	444	144	3.0	2 1/4-40	56/80
041670	4	1,670	194	144	58	2,004	529	173	3.0	2 1/4-40	56/80
042100	4	2,100	194	180	58	-	-	-	3.0	2 1/4-40	56/80

Stroke length 10 mm

Plastic material design: max. 10 bar back pressure

The permissible priming pressure on the suction side is approximately 50% of the max. permitted back pressure

Materials in Contact With the Medium

Liquid end	Suction/ discharge connector	DN 25 ball valves			DN 32/DN 40 plate valves **			
		Seals	Valve balls	Valve seats	Seals	Valve plates/valve spring	Valve seats	
PPT	Polypropylene	PVDF	PTFE	Borosilicate glass	PTFE	PTFE	Ceramic/ Hast. C + CTFE**	PTFE
PCT	PVC	PVDF	PTFE	Borosilicate glass	PTFE	PTFE	Ceramic/ Hast. C + CTFE**	PTFE
TTT	PTFE with carbon	PVDF	PTFE	Ceramic	PTFE	PTFE	Ceramic/ Hast. C + CTFE**	PTFE
SST	Stainless steel mat. no. 1.4404	Stainless steel mat. no. 1.4581	PTFE	Stainless steel mat. no. 1.4401	PTFE	PTFE	Stainless steel 1.4404/Hast. C	PTFE

Multi-layer safety diaphragms with PTFE coating.

** The valve spring is coated with CTFE (similar to PTFE)

Special versions on request.



2.2 Diaphragm Metering Pump Makro TZ

2.2.2 Identity Code Ordering System for TZMb

Makro TZMb mechanically deflected diaphragm metering pump

TZMb		Drive type	
H	Main drive		
A	Add-on drive		
D	Double main drive		
B	Double add-on drive		
Type*			
120260	070430	040840	
120340	070570	041100	
120430	070720	041400	
120510	070860	041670	
120650	071070	042100	
Liquid end material **			
PC	PVC		
PP	Polypropylene		
SS	Stainless steel		
TT	PTFE + 25% carbon		
Sealing material			
T	PTFE		
Displacement body			
1	Multi-layer safety diaphragm with rupture indicator		
Liquid end version			
0	No valve springs		
1	With valve springs		
Hydraulic connection			
0	Standard connection		
1	PVC union nut and insert		
2	PP union nut and insert		
3	PVDF union nut and insert		
4	SS union nut and insert		
Version			
0	with ProMinent® logo		
2	no ProMinent® logo		
A	with ProMinent® logo, with frame, simplex		
B	with ProMinent® logo, with frame, duplex		
C	with ProMinent® logo, with frame, triplex		
M	Modified		
Electrical power supply			
S	3 ph. 230/400 V 50/60 Hz (WBS)		
R	Variable speed motor, 4-pole, 230/400 V		
V (0)	Variable speed motor with integr. frequency converter		
Z	Speed control kit		
L	3 ph. 230/400 V 50 Hz (Exe, Exd)		
P	3 ph. 230/400 V 60 Hz (Exe, Exd)		
V (2)	variable speed motor with integr. frequency converter (Exd)		
4	no motor, with motor flange 56 C		
7	no motor, with motor flange 120/80		
8	no motor, with motor flange 160/90		
0	No motor, externally mounted drive		
Enclosure rating			
0	IP 55 (Standard) ISO class F		
1	Exe version ATEX-T3		
2	Exd version ATEX-T4		
A	ATEX power end		
Stroke sensor			
0	No stroke sensor		
1	With stroke sensor (Namur)		
Stroke length adjustment			
0	Stroke length adjustment, manual		
1	230 V stroke actuator		
2	115 V stroke actuator		
3	230 V 0-20 mA stroke controller		
4	230 V 4-20 mA stroke controller		
5	115 V 0-20 mA stroke controller		
6	115 V 4-20 mA stroke controller (servo motors for Ex zones on request)		
Application			
0	Standard		

* Digits 1 + 2=back pressure [bar]; digits 3 - 6=capacity [l/h]

** Material version PCT/PPT/TTT max. 10 bar

2.2 Diaphragm Metering Pump Makro TZ

Motor Data

Identity code specification		Power supply			Remarks
S	3 ph, IP 55	220-240 V/380-420 V 250-280 V/440-480 V	50 Hz 60 Hz	0.75 kW	
R	3 ph, IP 55	230 V/400 V	50/60 Hz	1.5 kW	With PTC, speed adjustment range 1:20 with external fan 1 ph 230 V; 50/60Hz
V0	1 ph, IP 55	230 V ±5%	50/60 Hz	1.1 kW	Variable speed motor with integrated frequency converter
L1	3 ph, II2GEEExII T3	220-240 V/380-420 V	50 Hz	0.75 kW	
L2	3 ph, II2GEEExdII CT4	220-240 V/380-420 V	50 Hz	0.75 kW	With PTC, speed control range 1:5
P1	3 ph, II2GEEExII T3	250-280 V/440-480 V	60 Hz	0.75 kW	
P2	3 ph, II2GEEExdII CT4	250-280 V/440-480 V	60 Hz	0.75 kW	With PTC, speed control range 1:5
V2	3 ph, II2GEEExdII CT4	400 V ±10%	50/60 Hz	1.5 kW	Ex-variable speed motor with integrated frequency converter

Motor data sheets can be requested for more information. Motors for Sigma basic pumps, special motors or special motor flanges are available on request.

The motors are designed in compliance with the Ecodesign Directive 2009/125/EC.

Information for use in areas at risk from explosion

Only use pumps with the appropriate labelling in line with the ATEX Directive 94/9/EC in premises at risk from explosion. Ensure that the explosion group, category and degree of protection specified on the label corresponds to or is better than the conditions prevalent in the intended field of application.

2.2.3

Spare Parts

The spare parts kit generally includes the wear parts for the liquid ends.

- 1 Metering diaphragm (multi-layer safety diaphragm)
- 1 Suction valve complete
- 1 Discharge valve complete
- 2 Valve balls (DN 32/DN 40 with plate and spring)
- 1 Complete sealing set (O-rings or flat seals, valve seats, valve seat bushings)

Spare Parts Kits for Diaphragm Metering Pump Makro TZ (TZMb)

Identity Code: 120260, 120340, 120430, 120510, 120650

Liquid end	Materials in contact with the medium	Order no.
FM 650 - DN 25	PCT, PPT, TTT	1025164
	SST	1022896
	SST without valves cpl.	1022895

Identity Code: 070430, 070570, 070720, 070860, 071070

Liquid end	Materials in contact with the medium	Order no.
FM 1100 - DN 32	PCT, PPT, TTT	1025167
	SST	1022917
	SST without valves cpl.	1022916





2.2 Diaphragm Metering Pump Makro TZ

Identity Code: 040840, 041100, 041400, 041670, 042100

Liquid end	Materials in contact with the medium	Order no.
FM 2100 - DN 40	PCT, PPT, TTT	1025169
	SST	1022930
	SST without valves cpl.	1022929

Multi-Layer Metering Diaphragm for TZMb

ProMinent multi-layer safety diaphragm with diaphragm rupture warning system and PTFE Teflon coating on the wetted side.

Pump type	Order no.
Identity code: 120260, 120340, 120430, 120510, 120650; Makro TZ FM 650	1022887
Identity code: 070430, 070570, 070720, 070860, 071070; Makro TZ FM 1100	1022900
Identity code: 040840, 041100, 041400, 041670, 042100; Makro TZ FM 2100	1022921

Spare Parts Kits for Diaphragm Metering Pump Makro TZ (TZMa)

Identity Code: 120190, 120254, 120317, 120381

Liquid end	Materials in contact with the medium	Order no.
FM 260 - DN 20	PP	910452
	P	910455
	T	910458
	S without valves cpl.	910475
	S	910461

Identity Code: 060397, 060529, 060661, 060793

Liquid end	Materials in contact with the medium	Order no.
FM 530 - DN 25	PP	910453
	P	910456
	T	910459
	S without valves cpl.	910476
	S	910462

Identity Code: 030750, 031000, 031250, 031500, 031875, 031050, 031395, 031740, 032100, 032500

Liquid end	Materials in contact with the medium	Order no.
FM 1500/2100 - DN 40	PP	1001573
	P	1001574
	T	1001575
	S without valves cpl.	1001577
	S	1001576

2.2 Diaphragm Metering Pump Makro TZ

PTFE Metering Diaphragms for TZMa

ProMinent® DEVELOPAN® metering diaphragms with a generously-sized steel core vulcanised into fibre reinforced EPDM, with a PTFE Teflon coating on the process-wetted side.

Pump type	Order no.
Identity code: 100190, 120190, 100254, 100317, 120317, 100381, 120381; Makro TZ FM 260	811471
Identity code: 060397, 060529, 060661, 060793; Makro TZ FM 530	811472
Identity code: 030750, 031000, 031250, 031500, 031050, 031395, 031740, 032100, 032500; Makro TZ FM 1500/FM 2100	811473

Information for use in areas at risk from explosion

Only use pumps with the appropriate labelling in line with the ATEX Directive 94/9/EC in premises at risk from explosion. Ensure that the explosion group, category and degree of protection specified on the label corresponds to or is better than the conditions prevalent in the intended field of application.



2.3 Diaphragm Metering Pump Makro/ 5

2.3.1

Diaphragm Metering Pump Makro/ 5

It is not possible to do more with a mechanically deflected diaphragm

Capacity range of single pump: 1,540 – 4,000 l/h, 4 bar



The diaphragm metering pump Makro/ 5 is used to meter reactants and catalysts in the chemical industry. Thanks to its modular construction, it can adapt outstandingly to the actual requirements of each application.

The diaphragm metering pump Makro/ 5 (M5Ma) together with the Makro/ 5 hydraulic diaphragm and plunger metering pumps form a range of drive mechanisms with stroke lengths of 20 and/or 50 mm. This covers the capacity range from 38 to 6,000 l/h at 320 – 4 bar. A wide range of drive versions is available, including some for use in Exe and Exde areas with ATEX certification.

Your benefits

Process reliability:

- Metering reproducibility is better than $\pm 2\%$ within the 30-100% stroke length range under defined conditions and with correct installation.

Excellent flexibility:

- The modular construction with single and double head versions permits a wide range of applications, with the double head designs being operated in push-pull mode
- It is possible to combine up to 4 metering units, even with different pump capacities, in multiple pump systems
- 5 different gear ratios are available
- Customised designs are available on request

Technical Details

- Stroke length: 0-20 mm, Rod force: 10,000 N
- Stroke length adjustment range: 0 – 100 %
- Stroke length adjustment: manually by means of a manual adjustment wheel and scaled display in 0.5% increments (optionally with electric actuator or control drive)
- Metering reproducibility is better than $\pm 2\%$ within the 30 – 100% stroke length range under defined conditions and with correct installation. Observe the information in the operating instructions
- Wetted materials: Polypropylene, PVC, PTFE+25% carbon, stainless steel 1.4571, special materials are available on request
- A wide range of power end versions is available: three-phase standard motors, motors for use in Exe and Exde areas and different flange designs for use in customer-specific motors
- Degree of protection: IP 55
- Salt water-resistant, acrylic resin-coated cast iron housing
- For reasons of safety, provide suitable overload protection mechanisms during the installation of all mechanically deflected diaphragm metering pumps

Field of application

- Volume-proportional metering of chemicals/additives in water treatment
- Metering of reactants and catalysts in the chemical industry
- Level-dependent metering of additives in industrial production engineering

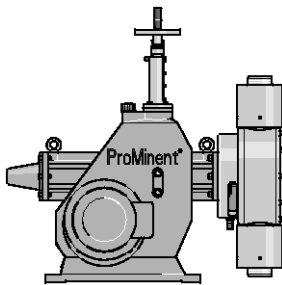

pk_2_099
Makro/ 5 M5Ma

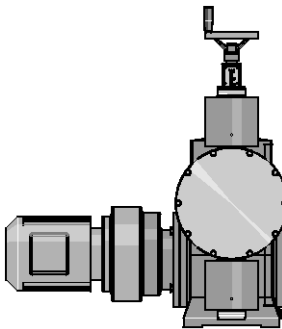

pk_2_093

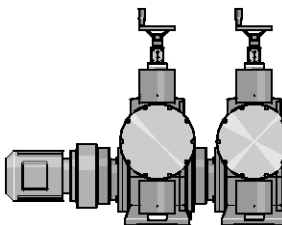

pk_2_098
Makro/ 5 externally mounted pump

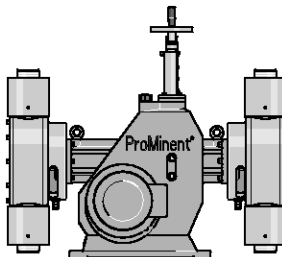

pk_2_095
Makro/ 5 double head pump



2.3 Diaphragm Metering Pump Makro/ 5

Technical Data

Type M5Ma	With 1500 rpm motor at 50 Hz				With 1800 rpm motor at 60 Hz				Suction lift m WC	Connection, suction/ discharge side G-DN	Shipping weight kg
	Delivery rate at max. back pressure		Max. stroke rate		Delivery rate at max. back pressure		Max. stroke rate				
	bar	l/h	ml/ stroke	Strokes/min	psi	l/h	gph (US)	Strokes/min			
041540	4	1,540	427	60	58	1,822	481	71	3.0	2 3/4-50	320
041900	4	1,900	427	75	58	2,254	595	89	3.0	2 3/4-50	320
042600	4	2,600	427	103	58	3,104	820	123	3.0	2 3/4-50	320
043400	4	3,400	427	133	58	4,064	1,074	159	3.0	2 3/4-50	320
044000	4	4,000	427	156	58	-	-	-	3.0	2 3/4-50	320

Stainless steel version: Shipping weight 340 kg

The permissible admission pressure on the intake side is approx. 50% of the maximum permissible back pressure.

Materials in Contact With the Medium

		DN 50 plate valves			
Liquid end	Suction/discharge valve	Seals	Valve plates/valve spring	Valve seats	
PPT Polypropylene	Polypropylene	PTFE	Ceramic/ Hast. C + CTFE**	PTFE	
PCT PVC	PVC	PTFE	Ceramic/ Hast. C + CTFE**	PTFE	
TTT PTFE with carbon	PTFE with carbon	PTFE	Ceramic/ Hast. C + CTFE**	PTFE	
SST Stainless steel mat. no. 1.4571/1.4404	Stainless steel mat. no. 1.4571/1.4404	PTFE	Stainless steel mat. no. 1.4404/ Hast. C	PTFE	

DEVELOPAN® metering diaphragm with PTFE coating.

** The valve spring is coated with CTFE (similar to PTFE)
Special versions on request.

Motor Data

Identity code specification	Power supply	Remarks
S 3 ph, IP 55	220-240 V/380-420 V 250-280 V/440-480 V	50 Hz 3 kW 60 Hz
R 3 ph, IP 55	230 V/400 V	50/60 Hz 3 kW With PTC, speed control range 1:5
L1 3 ph, II2GEEExIIIT3	220-240 V/380-420 V	50 Hz 3.6 kW
L2 3 ph, II2GEEExIIICT4	220-240 V/380-420 V	50 Hz 4 kW With PTC, speed control range 1:5
P1 3 ph, II2GEEExIIIT3	250-280 V/440-480 V	60 Hz 3.6 kW
P2 3 ph, II2GEEExIIICT4	250-280 V/440-480 V	60 Hz 4 kW With PTC, speed control range 1:5

Motor data sheets can be requested for more information. Motors for Sigma basic pumps, special motors or special motor flanges are available on request.

The motors are designed in compliance with the Ecodesign Directive 2009/125/EC.

Information for use in areas at risk from explosion

Only use pumps with the appropriate labelling in line with the ATEX Directive 94/9/EC in premises at risk from explosion. Ensure that the explosion group, category and degree of protection specified on the label corresponds to or is better than the conditions prevalent in the intended field of application.





2.3 Diaphragm Metering Pump Makro/ 5

2.3.2 Identity Code Ordering System M5Ma

Motor-driven metering pump M5Ma with mechanically deflected diaphragm

M5Ma	Drive type
H	Main drive
D	Double main drive
A	Add-on drive
B	Double add-on drive
Type	
041540	
041900	
042600	
043400	
044000	
Liquid end material	
PC	PVC
PP	Polypropylene
SS	Stainless steel
TT	PTFE + 25% carbon
Sealing material	
T	PTFE
Displacement body	
T	Pump diaphragm with PTFE coating
Liquid end version	
1	With valve springs, Hast. C; 0.1 bar
Hydraulic connection	
0	Standard connection
1	PVC union nut and insert
2	PP union nut and insert
3	PVDF union nut and insert
4	SS union nut and insert
Version	
0	with ProMinent® logo, no frame
2	without ProMinent® logo, no frame
A	with ProMinent® logo, with frame, simplex
B	with ProMinent® logo, with frame, duplex
C	with ProMinent® logo, with frame, triplex
D	with ProMinent® logo, with frame, quadruplex
M	Modified
Electrical power supply	
S	3 ph. 230/400 V 50/60 Hz (WBS)
R	Variable speed motor 4-pole 230/400 V (R 1:5)
Z	Speed control complete 230/400 V, 50/60 Hz
L	3 ph. 230/400 V 50 Hz (Exe, Exd)
P	3 ph. 460 V 60 Hz (Exe, Exd)
5	No motor, with IEC 100 gearbox
6	No motor, with IEC 112 gearbox
0	No motor, no gearbox
Enclosure rating	
0	IP 55 (Standard) ISO class F
1	Exe version ATEX-T3
2	Exd version ATEX-T4
A	ATEX power end
Stroke sensor	
0	No stroke sensor
1	With stroke sensor (Namur)
Stroke length adjustment	
0	Stroke length adjustment, manual
3	230 V 0-20 mA stroke controller
4	230 V 4-20 mA stroke controller
5	115 V 0-20 mA stroke controller
6	Control drive 115 V 4-20 mA
-	Other designs, such as explosion-proof, on request
Application	
0	Standard
3	Temperature up to -20 °C

2.3 Diaphragm Metering Pump Makro/ 5

2.3.3

Spare Parts

Spare Parts Kits for Diaphragm Metering Pump Makro/ 5 HM

The replacement part kit in general includes wear parts for the liquid ends.

- 1 Metering diaphragm
- 1 Suction valve compl.
- 1 Discharge valve compl.
- 2 Valve plate and Hast. C spring
- 1 Seal kit complete (envelope rings, valve seat/valve seat bushing)

Liquid end	Order no.
FM 4000 PCT	1008172
FM 4000 PPT	1008171
FM 4000 TTT	1008173
FM 4000 SST without valves cpl.	1008174

PTFE Metering Diaphragms

DEVELOPAN® diaphragm made of EPDM with woven fabric inlay, large-area, vulcanised aluminium core and PTFE-Teflon layer on the side in contact with the medium.

	Order no.
Metering diaphragm for Makro/ 5 FM 4000	1009023



2.4 Hydraulic Diaphragm Metering Pump Hydro/ 2

2.4.1 Hydraulic Diaphragm Metering Pump Hydro/ 2

For flexible metering with excellent process reliability in the medium pressure range.

Capacity range of single pump: 3 – 72 l/h, 100 – 25 bar

As an extremely robust hydraulic diaphragm metering pump, the Hydro/ 2 meets the most exacting safety requirements. Its modular construction, with either one or two dosing heads, 4 gear ratios, 2 dosing head sizes and 3 dosing head materials, offers a very high degree of flexibility in terms of areas of application.



The Hydro/ 2 hydraulic diaphragm metering pump (HP2a) together with the Hydro/ 3 and Hydro/ 4 pumps represent an integrated product range with stroke lengths of 15 and/or 20 mm. This covers the capacity range from 3 to 1,450 l/h at 100 – 7 bar. A wide range of drive versions is available, including some for use in Exe and Exde areas with ATEX certification. The Hydro product range is designed to comply with API 675 among others.

Your benefits

Excellent process safety and reliability:

- PTFE multi-layer diaphragm with integral diaphragm rupture warning system
- Integral hydraulic relief valve
- Metering reproducibility is better than $\pm 1\%$ within the 20-100% stroke volume range under defined conditions and with proper installation

Excellent flexibility:

- The modular construction with single and double head versions permits a wide range of applications, with the double head designs being operated in push-pull mode
- It is possible to combine up to 5 metering units, even with different pump capacities, in multiple pump systems
- 5 different gear ratios are available

Technical Details

- Stroke length: 15 mm, Rod force: 2,000 N
- Stroke volume adjustment range: 0 – 100%
- Stroke volume adjustment: manually by scaled rotary dial (optionally with electric actuator or control drive)
- Metering reproducibility is better than $\pm 1\%$ in the 20 to 100% stroke volume range under defined conditions and with correct installation
- PTFE multi-layer diaphragm with electric diaphragm rupture warning system via a contact
- Integrated hydraulic relief and bleed valve
- Wetted materials: PVDF, PTFE+25% carbon, stainless steel 1.4571, Hastelloy C.
- A wide range of power end versions is available: three-phase standard or 1-phase AC motor, motors for use in Exe and Exde areas, different flange designs for use in customer-specific motors
- Degree of protection: IP 55
- Design in compliance with API 675 among others

Field of application

- Oil and gas industry
- Volume-proportional metering of chemicals/additives in the treatment of boiler feed water
- Metering of reactants and catalysts in the chemical industry
- Level-dependent metering of auxiliary agents in industrial production engineering, for instance hot wax metering in the production of adhesive strips

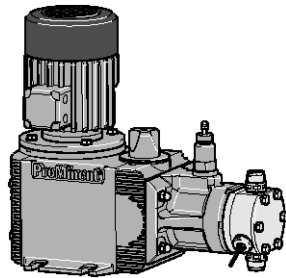

pk_2_074
Hydro

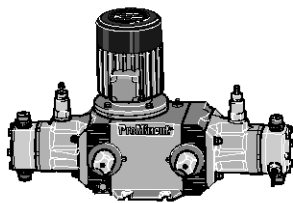

pk_2_073
Hydro double head pump

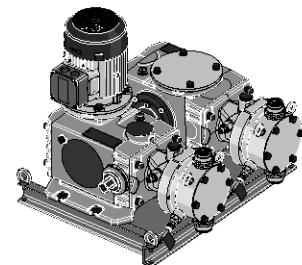

P_HY_0040_SW1
Hydro externally mounted pump

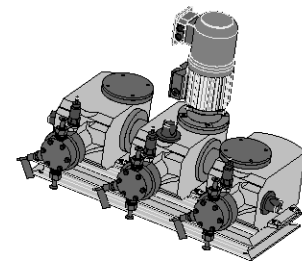

P_PZ_0001_SW1
Hydro triplex pump



2.4 Hydraulic Diaphragm Metering Pump Hydro/ 2

Technical Data

Type HP2a	With 1500 rpm motor at 50 Hz				With 1800 rpm motor at 60 Hz			Suction lift m WC	Perm. pre- pressure suction side bar	Connection on suction/ pressure side G-DN	Ship- ping weight kg	Plunger Ø mm
	Delivery rate at max. back pressure		Max. stroke rate Strokes/ min	Delivery rate at max. back pressure		Max. stroke rate Strokes/ min						
	bar	l/h		ml/ stroke	psi		l/h/gph (US)					
100003*	100	3	0.8	60	1,450	3.6/1.0	72	3.0	5	Rp 1/4*	31	16
100006*	100	6	0.8	125	1,450	7.0/1.8	150	3.0	5	Rp 1/4*	31	16
100007*	100	7	0.8	150	1,450	8.0/2.1	180	3.0	5	Rp 1/4*	31	16
100009*	100	9	0.8	187	1,450	11.0/2.9	224	3.0	5	Rp 1/4*	31	16
100010*	100	10	0.8	212	–	–	–	3.0	5	Rp 1/4*	31	16
064007	64	7	2.0	60	928	8.4/2.2	72	3.0	5	G 3/4-10	31	18
064015	64	15	2.0	125	928	18.0/4.8	150	3.0	5	G 3/4-10	31	18
064018	64	18	2.0	150	928	21.0/5.5	180	3.0	5	G 3/4-10	31	18
064022	64	22	2.0	187	928	26.0/6.9	224	3.0	5	G 3/4-10	31	18
064025	64	25	2.0	212	–	–	–	3.0	5	G 3/4-10	31	18
025019	25	19	5.3	60	362	23.0/6.1	72	3.0	5	G 3/4-10**	31	26
025040	25	40	5.3	125	362	48.0/12.7	150	3.0	5	G 3/4-10**	31	26
025048	25	48	5.3	150	362	58.0/15.3	180	3.0	5	G 3/4-10**	31	26
025060	25	60	5.3	187	362	72.0/19.0	224	3.0	5	G 3/4-10**	31	26
025068	25	68	5.3	212	–	–	–	3.0	5	G 3/4-10**	31	26

Version PVDF max. 25 bar.

* Version SST/HCT with double ball valve, valve connector on the suction-pressure with female thread Rp 1/4 and external thread G 3/4 - DN 10

** HV design with G1 - DN 15 connector

Materials in Contact With the Medium

Material	Dosing head	Suction/pressure connector	Seals/ball seat	Balls
SST	Stainless steel 1.4571/1.4404	Stainless steel 1.4581	PTFE/ZrO ₂ (DN 15 – stainless steel 1.4404)	Ceramic
PVT*	PVDF (polyvinylidene fluoride)	PVDF (polyvinylidene fluoride)	PTFE/PTFE	Ceramic
HCT	Hast. C	Hast. C	PTFE/Hast. C	Ceramic
TTT	PTFE + 25 % carbon	PVDF (polyvinylidene fluoride)	PTFE/PTFE	Ceramic

* not for areas at risk from explosion

Motor Data

Identity code specification		Power supply		Remarks	
S	3 ph, IP 55	220-240 V/380-420 V	50 Hz	0.37 kW	
		250-280 V/440-480 V	60 Hz		
T	3 ph, IP 55	220-240 V/380-420 V	50 Hz	0.37 kW	With PTC, speed adjustment range 1:5
		265-280 V/440-480 V	60 Hz		
R	3 ph, IP 55	230 V/400 V	50/60 Hz	0.37 kW	With PTC, speed adjustment range 1:20 with external fan 1ph 230 V; 50/60Hz
V0	1 ph, IP 55	230 V ±10%	50/60 Hz	0.37 kW	Variable speed motor with integrated frequency converter
L1	3 ph, II2GEEexIIIT3	220-240 V/380-420 V	50 Hz	0.37 kW	
L2	3 ph, II2GEEexIIICT4	220-240 V/380-420 V	50 Hz	0.37 kW	With PTC, speed adjustment range 1:5
P1	3 ph, II2GEEexIIIT3	254-277 V/440-480 V	60 Hz	0.37 kW	
P2	3 ph, II2GEEexIIICT4	254-277 V/440-480 V	60 Hz	0.37 kW	With PTC, speed adjustment range 1:5
V2	3 ph, II2GEEexIIICT4	400 V ±10%	50/60 Hz	0.55 kW	Ex-variable speed motor with integrated frequency converter.

Motor data sheets can be requested for more information. Motors for Sigma basic pumps, special motors or special motor flanges are available on request.

The motors are designed in compliance with the Ecodesign Directive 2009/125/EC.

Information for use in areas at risk from explosion

Only use pumps with the appropriate labelling in line with the ATEX Directive 94/9/EC in premises at risk from explosion. Ensure that the explosion group, category and degree of protection specified on the label corresponds to or is better than the conditions prevalent in the intended field of application.





2.4 Hydraulic Diaphragm Metering Pump Hydro/ 2

2.4.2 Identity Code Ordering System HP2a

Hydro/ 2 (HP2a)

HP2a		Drive type	
H	Main drive		
D	Main drive, double-head version		
E	Main drive for add on drive		
F	Main drive, double-head version for add-on drive		
A	Add-on drive		
B	Double-head version add-on drive		
T	Triplex comprising 3 power ends and 3 identical heads		
Type*			
	bar	l/h	
100003	100	3	064007 64 7 025019 25 19
100006	100	6	064015 64 15 025040 25 40
100007	100	7	064018 64 18 025048 25 48
100009	100	9	064022 64 22 025060 25 60
100010	100	10	064025 64 25 025068 25 68
Liquid end material			
SS	Stainless steel		
PV	PVDF (only for 025019 - 025068, 064007 - 064025)		
HC	Hastelloy C		
TT	PTFE + 25% carbon		
Sealing material*			
T	PTFE		
Displacement body*			
0	Standard multi-layer diaphragm with rupture signalling facility		
Liquid end version			
0	No valve springs (standard)		
1	With valve springs		
D	Double ball valve (only for SST and HCT)		
H	HV version (for 025019 – 025060 only, for SST only)		
Hydraulic connection			
0	Standard threaded connector		
E	With DIN ISO flange		
F	With ANSI flange		
Version			
0	with ProMinent® logo	M	Modified
1	without ProMinent® logo		
Electrical power supply			
S	3 ph, 230/400 V, 50/60 Hz, 0.37 kW		
T	3 ph, 230/400 V, 50/60 Hz, with PTC		
R	3 ph, Variable speed motor, 230 V/400 V, 0.37 kW		
V (0)	Variable speed motor with integrated frequency converter		
Z	1 ph, Variable speed control set, 230 V, 50/60 Hz		
L	3 ph, 230/400 V, 50 Hz (Exe, Exd), 0.37 kW		
P	3 ph, 265/400 V, 60 Hz (Exe, Exd), 0.37 kW		
V (2)	Variable speed motor with integr. frequency converter (Exd)		
1	no motor, with motor flange B 14, size 200		
3	no motor, with motor flange B5, size 160		
4	no motor, with motor flange NEMA 56 C		
0	Add on drive		
Enclosure rating			
0	IP 55 (standard)		
1	Exe motor version ATEX-T3		
2	Exde motor version ATEX-T4		
A	ATEX power end		
Stroke sensor			
0	No stroke sensor (standard)		
1	Stroke sensor (for explosion-proof applications)		
Stroke length adjustment			
0	Manual (standard)		
1	With stroke positioning motor, 230 V/50/60 Hz		
2	With stroke positioning motor, 115 V/60 Hz		
A	With stroke control motor 0...20 mA 230 V/50/60 Hz		
B	With stroke control motor 4...20 mA 230 V/50/60 Hz		
C	With stroke control motor 0...20 mA 115 V/60 Hz		
D	With stroke control motor 4...20 mA 115 V/60 Hz		
Hydraulic oil			
0	Standard		
1	Food grade		
2	Low temperature to -25 °C		
3	Low temperature Zone 2		

* PVT max. 25 bar

2.4 Hydraulic Diaphragm Metering Pump Hydro/ 2

2.4.3 Spare Parts

The spare parts kit generally includes the wear parts for the liquid ends.

Scope of delivery with SST/HCT material version

- 1 Diaphragm
- 2 Valve balls
- 1 Sealing set, complete

Scope of delivery with PVT material version

- 1 Diaphragm
- 1 Suction valve, complete
- 1 Discharge valve, complete
- 2 Valve balls
- 1 Sealing set, complete

Spare parts kits for Hydro/ 2

Applies to identity code: Type 100010, 100009, 100007, 100006, 100003, 064025, 064022, 064018, 064015, 064007

Liquid end	Materials in contact with the medium	Order no.
FMH 25 - DN 10	PVT	1005548
	SST	1005549
	SST	for double ball valves 1029260
	HCT	1009571
	SST	with valves cpl. 1005550

Applies to identity code: Type 025068, 025060, 025048, 025040, 025019

Liquid end	Materials in contact with the medium	Order no.
FMH 60 - DN 10	PVT	1005552
	SST	1005553
	SST	for double ball valves 1005555
	HCT	1009573
	SST	with valves cpl. 1005554
	SST (HV-Ausführung)	with valves, complete (DN 15) 1019812

PTFE/1.4404 Metering Diaphragms for Hydro/ 2

Liquid end	Order no.
FMH 25	Applies to identity code (SST): 100010, 100009, 100007, 100006, 100003, 064025, 064022, 064018, 064015, 064007 1005545
FMH 60	Applies to identity code (SST): 026068, 025060, 025048, 025040, 025019 1005546

Diaphragms PTFE/Hastelloy C Coated for Hydro/ 2

Liquid end	Order no.
FMH 25	Applies to identity code (PVT/HCT): 064025, 064022, 064018, 064015, 064007 1006481
FMH 60	Applies to identity code: 025068, 025060, 025048, 025040, 025019 1006482

Base for Hydro hydraulic diaphragm metering pumps

Order no.
Base for Hydro/ 2, dimensions: 300 x 160 x 128 mm (LxWxH) 1005660

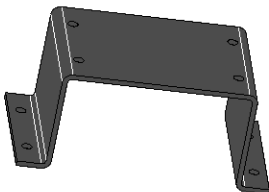

P_PZ_0010_SW1



2.5 Hydraulic Diaphragm Metering Pump Hydro/ 3

2.5.1 Hydraulic Diaphragm Metering Pump Hydro/ 3

For flexible metering with excellent process reliability in the medium pressure range.

Capacity range of single pump: 10 – 180 l/h, 100 – 25 bar



The Hydro/ 3 is an extremely robust hydraulic diaphragm metering pump. It meets the most exacting safety requirements. Its modular construction offers extremely good flexibility in terms of application, for example in the oil and gas industry.

The Hydro/ 3 hydraulic diaphragm metering pump (HP3a) together with the Hydro/ 2 and Hydro/ 4 pumps represent an integrated product range with stroke lengths of 15 and/or 20 mm. This covers the capacity range from 3 to 1,450 l/h at 100 – 7 bar. A wide range of drive versions is available, including some for use in Exe and Exde areas with ATEX certification. The Hydro product range is designed to comply with API 675 among others.

Your benefits

Excellent process safety and reliability:

- PTFE multi-layer diaphragm with integral diaphragm rupture warning system
- Integral hydraulic relief valve
- Metering reproducibility is better than $\pm 1\%$ within the 20-100% stroke volume range under defined conditions and with proper installation

Excellent flexibility:

- The modular construction with single and double head versions permits a wide range of applications, with the double head designs being operated in push-pull mode
- It is possible to combine up to 5 metering units, even with different pump capacities, in multiple pump systems
- 5 different gear ratios are available
- Customised designs are available on request

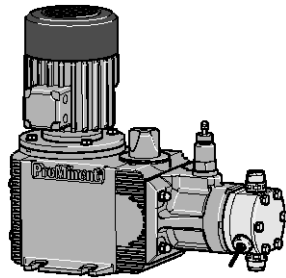

pk_2_074
Hydro

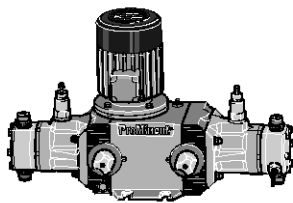

pk_2_073
Hydro double head pump

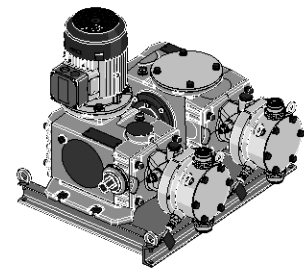

P_HY_0040_SW1
Hydro externally mounted pump

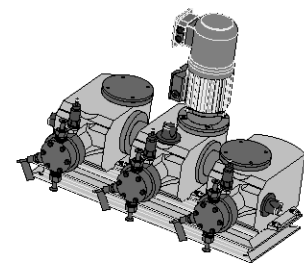

P_PZ_0001_SW1
Hydro triplex pump

Technical Details

- Stroke length: 15 mm, Rod force: 4,200 N
- Stroke volume adjustment range: 0 – 100%
- Stroke volume adjustment: manually by scaled rotary dial (optionally with electric actuator or control drive)
- Metering reproducibility is better than $\pm 1\%$ in the 20 – 100% stroke volume range under defined conditions and with correct installation
- PTFE multi-layer diaphragm with electrical diaphragm rupture warning system via a contact
- Integrated hydraulic relief and bleed valve
- Wetted materials: PVDF, PTFE+25% carbon, stainless steel 1.4571, Hastelloy C.
- A wide range of power end versions is available: three-phase standard or 1-phase AC motor, motors for use in Exe and Exde areas, different flange designs for use in customer-specific motors
- Degree of protection: IP 55
- Design in compliance with API 675 among others

Field of application

- Oil and gas industry.
- Volume-proportional metering of chemicals/additives in the treatment of boiler feed water
- Metering of reactants and catalysts in the chemical industry
- Level-dependent metering of auxiliary agents in industrial production engineering, for instance hot wax metering in the production of adhesive strips



2.5 Hydraulic Diaphragm Metering Pump Hydro/ 3

Technical Data

Type HP3a	With 1500 rpm motor at 50 Hz				With 1800 rpm motor at 60 Hz			Suction lift m WC	Perm. pre- pressure suction side bar	Connection suction/ discharge side G-DN	Shipping weight kg	Plunger Ø mm
	Delivery rate at max. back pressure		Max. stroke rate		Delivery rate at max. back pressure		Max. stroke rate					
	bar	l/h	ml/ stroke	Strokes/ min	psi	l/h/gph (US)	Strokes /min					
100010*	100	10	2.8	60	1,450	12/3.2	72	3.0	5	Rp 3/8-10*	41	22
100021*	100	21	2.8	125	1,450	25/6.6	150	3.0	5	Rp 3/8-10*	41	22
100025*	100	25	2.8	150	1,450	30/7.9	180	3.0	5	Rp 3/8-10*	41	22
100031*	100	31	2.8	187	1,450	37/9.8	224	3.0	5	Rp 3/8-10*	41	22
100035*	100	35	2.8	212	1,450		-	3.0	5	Rp 3/8-10*	41	22
064019	64	19	5.3	60	928	23/6.1	72	3.0	5	G 3/4-10**	41	26
064040	64	40	5.3	125	928	48/12.7	150	3.0	5	G 3/4-10**	41	26
064048	64	48	5.3	150	928	58/15.3	180	3.0	5	G 3/4-10**	41	26
064060	64	60	5.3	187	928	72/19.0	224	3.0	5	G 3/4-10**	41	26
064068	64	68	5.3	212	928		-	3.0	5	G 3/4-10**	41	26
025048	25	48	13.4	60	362	58/15.3	72	3.0	5	G 1-15***	41	38
025100	25	100	13.4	125	362	120/31.7	150	3.0	5	G 1-15***	41	38
025120	25	120	13.4	150	362	144/38.0	180	3.0	5	G 1-15***	41	38
025150	25	150	13.4	187	362	180/47.6	224	3.0	5	G 1-15***	41	38
025170	25	170	13.4	212	362		-	3.0	5	G 1-15***	41	38

Version PVDF max. 25 bar.

* Version SST/HCT with double ball valve, valve connector on the suction/discharge side with female thread Rp 3/8 and external thread G 3/4 - DN 10

** HV design (SST only) with G 1 - DN 15 connector

*** HV design (SST only) with 1 1/4" DN 20 connector

Materials in Contact With the Medium

Material	Dosing head	Suction/pressure connector	Seals/ball seat	Balls
SST	Stainless steel 1.4571/1.4404	Stainless steel 1.4581	PTFE/ZrO ₂ (DN 15 - stainless steel 1.4404)	Ceramic
PVT*	PVDF (polyvinylidene fluoride)	PVDF (polyvinylidene fluoride)	PTFE/PTFE	Ceramic
HCT	Hast. C	Hast. C	PTFE/Hast. C	Ceramic
TTT	PTFE + 25 % carbon	PVDF (polyvinylidene fluoride)	PTFE/PTFE	Ceramic

* not for areas at risk from explosion

Motor Data

Identity code specification		Power supply		Remarks	
S	3 ph, IP 55	220-240 V/380-420 V	50 Hz	0.75 kW	
		250-280 V/440-480 V	60 Hz		
T	3 ph, IP 55	220-240 V/380-420 V	50 Hz	0.75 kW	with PTC, speed adjustment range 1:5
		265-280 V/440-480 V	60 Hz		
R	3 ph, IP 55	230 V/400 V	50/60 Hz	0.75 kW	with PTC, speed control range 1:20 with external fan 1 ph 230 V; 50/60 Hz
V0	1 ph, IP 55	230 V ±10%	50/60 Hz	0.75 kW	Variable speed motor with integrated frequency converter
L1	3 ph, II2GEEExIIIT3	220-240 V/380-420 V	50 Hz	0.75 kW	
L2	3 ph, II2GEEExdIICT4	220-240 V/380-420 V	50 Hz	0.75 kW	with PTC, speed adjustment range 1:5
P1	3 ph, II2GEEExIIIT3	254-277 V/440-480 V	60 Hz	0.75 kW	
P2	3 ph, II2GEEExdIICT4	254-277 V/440-480 V	60 Hz	0.75 kW	with PTC, speed adjustment range 1:5
V2	3 ph, II2GEEExdIICT4	400 V ±10%	50/60 Hz	0.75 kW	Ex-variable speed motor with integrated frequency converter.

Motor data sheets can be requested for more information.

Motors for Sigma basic pumps, special motors or special motor flanges are available on request.

The motors are designed in compliance with the Ecodesign Directive 2009/125/EC.

Information for use in areas at risk from explosion

Only use pumps with the appropriate labelling in line with the ATEX Directive 94/9/EC in premises at risk from explosion. Ensure that the explosion group, category and degree of protection specified on the label corresponds to or is better than the conditions prevalent in the intended field of application.



2.5 Hydraulic Diaphragm Metering Pump Hydro/ 3

2.5.2 Identity Code Ordering System HP3a

Hydro/ 3 (HP3a)

HP3a Drive type																																																							
H	Main drive																																																						
D	Main drive, double-head version																																																						
E	Main drive for add-on drive																																																						
F	Main drive, double-head version for add-on drive																																																						
A	Add-on drive																																																						
B	Double-head version add-on drive																																																						
T	Triplex comprising 3 power ends and 3 identical heads																																																						
Type*																																																							
	<table border="1"> <thead> <tr> <th></th> <th>bar</th> <th>l/h</th> <th></th> <th>bar</th> <th>l/h</th> <th></th> <th>bar</th> <th>l/h</th> </tr> </thead> <tbody> <tr> <td>100010</td> <td>100</td> <td>10</td> <td>064019</td> <td>64</td> <td>19</td> <td>025048</td> <td>25</td> <td>48</td> </tr> <tr> <td>100021</td> <td>100</td> <td>21</td> <td>064040</td> <td>64</td> <td>40</td> <td>025100</td> <td>25</td> <td>100</td> </tr> <tr> <td>100025</td> <td>100</td> <td>25</td> <td>064048</td> <td>64</td> <td>48</td> <td>025120</td> <td>25</td> <td>120</td> </tr> <tr> <td>100031</td> <td>100</td> <td>31</td> <td>064060</td> <td>64</td> <td>60</td> <td>025150</td> <td>25</td> <td>150</td> </tr> <tr> <td>100035</td> <td>100</td> <td>35</td> <td>064068</td> <td>64</td> <td>68</td> <td>025170</td> <td>25</td> <td>170</td> </tr> </tbody> </table>		bar	l/h		bar	l/h		bar	l/h	100010	100	10	064019	64	19	025048	25	48	100021	100	21	064040	64	40	025100	25	100	100025	100	25	064048	64	48	025120	25	120	100031	100	31	064060	64	60	025150	25	150	100035	100	35	064068	64	68	025170	25	170
	bar	l/h		bar	l/h		bar	l/h																																															
100010	100	10	064019	64	19	025048	25	48																																															
100021	100	21	064040	64	40	025100	25	100																																															
100025	100	25	064048	64	48	025120	25	120																																															
100031	100	31	064060	64	60	025150	25	150																																															
100035	100	35	064068	64	68	025170	25	170																																															
Liquid end material																																																							
SS	Stainless steel																																																						
PV	PVDF (max. 25 bar, only for 025048 - 025170, 064019 - 064068)																																																						
HC	Hastelloy C																																																						
TT	PTFE + 25% carbon																																																						
Sealing material*																																																							
T	PTFE																																																						
Displacement body*																																																							
0	Standard multi-layer diaphragm with rupture signalling facility																																																						
Liquid end version																																																							
0	No valve springs (standard)																																																						
1	With valve springs																																																						
D	Double ball valve (for 100010-100035, 064019-064060, only for SST and HCT)																																																						
H	HV design (for 064019 - 064060, 25048 - 25170, SST only)																																																						
Hydraulic connection																																																							
0	Standard threaded connector																																																						
E	With DIN ISO flange																																																						
F	With ANSI flange																																																						
Version																																																							
0	with ProMinent® logo																																																						
1	without ProMinent® logo																																																						
M	Modified																																																						
Electrical power supply																																																							
S	3 ph, 230/400 V, 50/60 Hz, 0.75 kW																																																						
T	3 ph, 230/400 V, 50/60 Hz, with PTC																																																						
R	3 ph, variable speed motor, 230 V/400 V, 0.75 kW																																																						
V (0)	Variable speed motor with integrated frequency converter																																																						
Z	1 ph, variable speed control set, 230 V, 50/60 Hz																																																						
L	3 ph, 230/400 V 50 Hz (Exe, Exd), 0.75 kW																																																						
P	3 ph, 265/440 V 60 Hz (Exe, Exd), 0.75 kW																																																						
V (2)	Variable speed motor with integr. frequency converter (Exd)																																																						
1	no motor, with motor flange B 14, size 200																																																						
3	no motor, with motor flange B5, size 160																																																						
4	no motor, with motor flange NEMA 56 C																																																						
0	Add on drive																																																						
Enclosure rating																																																							
0	IP 55 (standard)																																																						
1	Exe motor version ATEX-T3																																																						
2	Exd motor version ATEX-T4																																																						
A	ATEX power end																																																						
Stroke sensor																																																							
0	No stroke sensor (standard)																																																						
1	Stroke sensor (for explosion-proof applications)																																																						
Stroke length adjustment																																																							
0	Manual (Standard)																																																						
1	With stroke positioning motor, 230 V/50/60 Hz																																																						
2	With stroke positioning motor, 115 V/60 Hz																																																						
A	With stroke control motor 0-20 mA 230 V/50/60 Hz																																																						
B	With stroke control motor 4-20 mA 230 V/50/60 Hz																																																						
C	With stroke control motor 0-20 mA 115 V/60 Hz																																																						
D	With stroke control motor 4-20 mA 115 V/60 Hz																																																						
Hydraulic oil																																																							
0	Standard																																																						
1	Food grade																																																						
2	Low temperature to -25 °C																																																						

* PVT max. 25 bar



2.5 Hydraulic Diaphragm Metering Pump Hydro/ 3

2.5.3 Spare Parts

The spare parts kit generally includes the wear parts for the liquid ends.

Scope of delivery with SST/HCT material version

- 1 Diaphragm
- 2 Valve balls
- 1 Sealing set, complete

Scope of delivery with PVT material version

- 1 Diaphragm
- 1 Suction valve, complete
- 1 Discharge valve, complete
- 2 Valve balls
- 1 Sealing set, complete

Spare parts kits for Hydro/ 3

Applies to identity code: Type 100035, 100031, 100025, 100021, 100010, 064068, 064060, 064048, 064040, 064019

Liquid end	Materials in contact with the medium	Order no.
FMH 60 - DN 10	PVT	1005552
	SST	1005553
	SST	for double ball valves 1005555
	HCT	1009573
	SST	with valves cpl. 1005554
	SST (HV-Ausführung) with valves, complete (DN 15)	1019812

Applies to identity code: Type 025170, 025150, 025120, 025100, 025048

Liquid end	Materials in contact with the medium	Order no.
FMH 150 - DN 15	PVT	1005556
	SST	1005557
	HCT	1009575
	SST	with valves cpl. 1005558
	SST (HV-Ausführung) with valves, complete (DN 20)	1019824

Metering Diaphragm PTFE/1.4404 for Hydro/ 3

Liquid end	Order no.
FMH 60	Applies to identity code (SST) 064025, 064022, 064018, 064015, 064007, 100010, 100009, 100007, 100006, 100003 1005546
FMH 150	Applies to identity code (SST): 025170, 025150, 025120, 025100, 025048 1005547

Diaphragms PTFE/Hastelloy C Coated for Hydro/ 3

Liquid end	Order no.
FMH 25	Applies to identity code (PVT/HCT): 064025, 064022, 064018, 064015, 064007 1006481
FMH 60	Applies to identity code: 025068, 025060, 025048, 025040, 025019 1006482

Base for Hydro hydraulic diaphragm metering pumps

Order no.
Base for Hydro/ 3, dimensions: 324 x 180 x 128 mm (LxWxH) 1005661

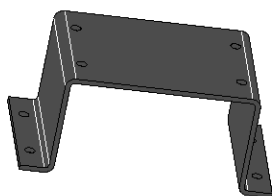

P_PZ_0010_SW1



2.6 Hydraulic Diaphragm Metering Pump Hydro/ 4

2.6.1 Hydraulic Diaphragm Metering Pump Hydro/ 4

For flexible metering with excellent process reliability in the medium pressure range.

Capacity range of single pump: 130 – 1,450 l/h, 25 – 7 bar



The Hydro/ 4 is an extremely robust hydraulic diaphragm metering pump, which meets the most exacting safety requirements – it is equipped as standard with a pressure relief valve and PTFE multi-layer diaphragm with diaphragm rupture warning system. Its modular construction offers extremely good flexibility in terms of applications.

The Hydro/ 4 hydraulic diaphragm metering pump (HP4a) together with the Hydro/ 2 and Hydro/ 3 pumps represent an integrated product range with stroke lengths of 15 and/or 20 mm. This covers the capacity range from 3 to 1,450 l/h at 100 – 7 bar. A wide range of drive versions is available, including some for use in Exe and Exde areas with ATEX certification. The Hydro product range is designed to comply with API 675 among others.

Your benefits

Excellent process safety and reliability:

- PTFE multi-layer diaphragm with integral diaphragm rupture warning system
- Integral hydraulic relief valve
- Metering reproducibility is better than $\pm 1\%$ in the 20-100% stroke volume range under defined conditions and with proper installation.

Excellent flexibility:

- The modular construction with single and double head versions permits a wide range of applications, with the double head designs being operated in push-pull mode
- It is possible to combine up to 5 metering units, even with different pump capacities, in multiple pump systems
- 5 different gear ratios are available
- Customised designs are available on request

Technical Details

- Stroke length: 20 mm, Rod force: 5,800 N
- Stroke volume adjustment range: 0 – 100%
- Stroke volume adjustment: manually by scaled rotary dial (optionally with electric actuator or control drive).
- Metering reproducibility is better than $\pm 1\%$ in the 20 – 100% stroke volume range under defined conditions and with correct installation
- PTFE multi-layer diaphragm with electrical diaphragm rupture warning system via a contact
- Integrated hydraulic relief and bleed valve
- Wetted materials: PVDF, PTFE+25% carbon, stainless steel 1.4571, Hastelloy C.
- A wide range of power end versions is available: three-phase standard or 1-phase AC motor, motors for use in Exe and Exde areas, different flange designs for use in customer-specific motors
- Degree of protection: IP 55
- Design in compliance with API 675 among others

Field of application

- Oil and gas industry.
- Volume-proportional metering of chemicals/additives in the treatment of boiler feed water
- Metering of reactants and catalysts in the chemical industry
- Level-dependent metering of auxiliary agents in industrial production engineering, for instance hot wax metering in the production of adhesive strips

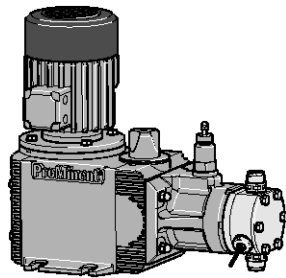

pk_2_074
Hydro

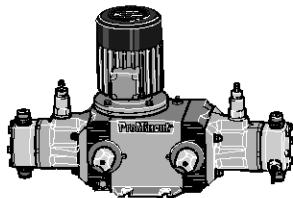

pk_2_073
Hydro double head pump

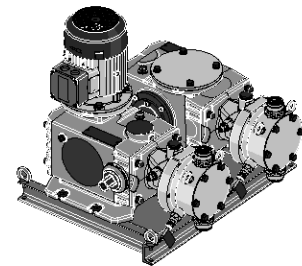

P_HY_0040_SW1
Hydro externally mounted pump

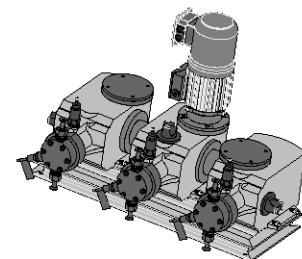

P_PZ_0001_SW1
Hydro triplex pump



2.6 Hydraulic Diaphragm Metering Pump Hydro/ 4

Technical Data

Type HP4a	With 1500 rpm motor at 50 Hz			With 1800 rpm motor at 60 Hz			Suction lift m WC	Perm. pre- pressure suction side bar	Connection suction/ discharge side G-DN	Shipping weight kg	Plunger Ø mm
	Delivery rate at max. back pressure bar	l/h	Max. stroke rate Strokes/ min	Delivery rate at max. back pressure psi	l/h/gph (US)	Max. stroke rate Strokes/ min					
250130	25	130	71	363	155/41	86	3	1	G 1 1/2-25	69	52
250190	25	190	103	363	230/61	124	3	1	G 1 1/2-25	69	52
250250	25	250	136	363	300/79	164	3	1	G 1 1/2-25	69	52
250350	25	350	188	363	420/111	225	3	1	G 1 1/2-25	69	52
250400	25	400	214	-	-	-	3	1	G 1 1/2-25	69	52
160210	16	210	71	232	250/66	86	3	1	G 1 1/2-25	76	63
160300	16	300	103	232	360/95	124	3	1	G 1 1/2-25	76	63
160400	16	400	136	232	480/127	164	3	1	G 1 1/2-25	76	63
160550	16	550	188	232	660/174	225	3	1	G 1 1/2-25	76	63
160625	16	625	214	-	-	-	3	1	G 1 1/2-25	76	63
100330	10	330	71	145	400/106	86	3	1	G 2-32	87	80
100480	10	480	103	145	580/153	124	3	1	G 2-32	87	80
100635	10	635	136	145	760/201	164	3	1	G 2-32	87	80
100880	10	880	188	145	1,050/277	225	3	1	G 2-32	87	80
101000	10	1,000	214	-	-	-	3	1	G 2-32	87	80
070465	7	465	71	102	560/148	86	3	1	G 2 1/4-40	96	94
070670	7	670	103	102	805/213	124	3	1	G 2 1/4-40	96	94
070890	7	890	136	102	1,070/283	164	3	1	G 2 1/4-40	96	94
071230	7	1,230	188	102	1,450/383	225	3	1	G 2 1/4-40	96	94
071400	7	1,400	214	-	-	-	3	1	G 2 1/4-40	96	94

Materials in Contact With the Medium

Material	Dosing head	Suction/pressure connector	DN 25 ball valves			DN 32/DN 40 plate valves		
			Seals	Valve balls	Valve seats	Seals	Valve plates/ valve springs	Valve seats
SST	Stainless steel 1.4404	Stainless steel 1.4404	PTFE	Stainless steel 1.4404	PTFE	PTFE	Stainless steel 1.4404/ Hast. C	PTFE
PVT*	PVDF (polyvinylidene fluoride)	PVDF (polyvinylidene fluoride)	PTFE	Glass	PTFE	PTFE	Ceramic/E-CTFE	PTFE
HCT	Hast. C	Hast. C	PTFE	Hast. C	PTFE	PTFE	Hast. C / E-CTFE	PTFE
TTT	PTFE + 25 % carbon	PVDF (polyvinylidene fluoride)	PTFE	Glass	PTFE	PTFE	Ceramic/E-CTFE	PTFE

* not for areas at risk from explosion

Motor Data

Identity code specification	Power supply	Remarks
S	3 ph, IP 55 220-240 V/380-420 V 250-280 V/440-480 V	50 Hz 1.1 kW 60 Hz
T	3 ph, IP 55 220-240 V/380-420 V 265-280 V/440-480 V	50 Hz 1.1 kW 60 Hz
R	3 ph, IP 55 230 V/400 V	50/60 Hz 1.5 kW
V0	3 ph, IP 55 400 V	50/60 Hz 1.5 kW
L1	3 ph, II2GEEexIIIT3	220-240 V/380-420 V 50 Hz 1.1 kW
L2	3 ph, II2GEEExdIICT4	220-240 V/380-420 V 50 Hz 1.1 kW
P1	3 ph, II2GEEexIIIT3	254-277 V/440-480 V 60 Hz 1.1 kW
P2	3 ph, II2GEEExdIICT4	254-277 V/440-480 V 60 Hz 1.1 kW
V2	3 ph, II2GEEExdIICT4	400 V ±10% 50/60 Hz 1.5 kW

Motor data sheets can be requested for more information.

Motors for Sigma basic pumps, special motors or special motor flanges are available on request.

The motors are designed in compliance with the Ecodesign Directive 2009/125/EC.

Information for use in areas at risk from explosion

Only use pumps with the appropriate labelling in line with the ATEX Directive 94/9/EC in premises at risk from explosion. Ensure that the explosion group, category and degree of protection specified on the label corresponds to or is better than the conditions prevalent in the intended field of application.





2.6 Hydraulic Diaphragm Metering Pump Hydro/ 4

2.6.2 Identity Code Ordering System HP4a

Hydro/ 4 (HP4a)

HP4a Drive type											
H	Main drive										
D	Main drive, double-head version										
E	Main drive for add-on drive										
F	Main drive, double-head version for add-on drive										
A	Add-on drive										
B	Double-head version add-on drive										
T	Triplex comprising 3 power ends and 3 identical heads										
Type*											
	bar	l/h		bar	l/h		bar	l/h		bar	l/h
250130	25	130	160210	16	210	100330	10	330	070465	7	465
250190	25	190	160300	16	300	100480	10	480	070670	7	670
250250	25	250	160400	16	400	100635	10	635	070890	7	890
250350	25	350	160550	16	550	100880	10	880	071230	7	1,230
250400	25	400	160625	16	625	101000	10	1,000	071400	7	1,400
Liquid end material											
SS	Stainless steel										
PV	PVDF										
HC	Hastelloy C										
TT	PTFE + 25% carbon										
Sealing material											
T	PTFE										
Displacement body											
0	Standard multilayer diaphragm with rupture signalling facility										
Liquid end version											
0	No valve springs (standard)										
1	With valve springs										
Hydraulic connection											
0	Standard threaded connection										
E	With DIN ISO flange										
F	With ANSI flange										
Version											
0	with ProMinent® logo										
1	without ProMinent® logo										
3	With ProMinent® logo, with electrical overpressure display										
M	Modified										
Electrical power supply											
S	3 ph, 230/400 V, 50/60 Hz, 1.1 kW										
T	3 ph, 230/400 V, 50/60 Hz, with PTC										
R	3 ph, variable speed motor, 230/400 V, 1.5 kW										
V (0)	Variable speed motor with integrated frequency converter										
Z	1 ph, variable speed control set, 230 V, 50/60 Hz										
L	3 ph, 230/400 V 50 Hz (Exe, Exd), 1.1 kW										
P	3 ph, 265/440 V 60 Hz (Exe, Exd), 1.1 kW										
V (2)	Variable speed motor with integr. frequency converter (Exd)										
1	no motor, with motor flange 250										
3	no motor, with motor flange B5, size 200										
4	no motor, with motor flange NEMA 143/145 TC										
0	Add on drive										
Enclosure rating											
0	IP 55 (standard)										
1	Exe motor version ATEX-T3										
2	Exd motor version ATEX-T4										
A	ATEX power end										
Stroke sensor											
0	No stroke sensor (standard)										
1	Stroke sensor (for explosion-proof applications)										
Stroke length adjustment											
0	Manual (Standard)										
K	Manual (outdoor, SS)										
1	With stroke positioning motor, 230 V/50/60 Hz										
2	With stroke positioning motor, 115 V/60 Hz										
A	With stroke control motor 0-20 mA 230 V/50/60 Hz										
B	With stroke control motor 4-20 mA 230 V/50/60 Hz										
C	With stroke control motor 0-20 mA 115 V/60 Hz										
D	With stroke control motor 4-20 mA 115 V/60 Hz										
Hydraulic oil											
0	Standard										
1	Food grade										
2	Low temperature to -25 °C										

* PVT max. 25 bar

2.6 Hydraulic Diaphragm Metering Pump Hydro/ 4

2.6.3 Spare Parts

The spare parts kit generally includes the wear parts for the liquid ends.

Scope of delivery with SST/HCT material version

- 1 Diaphragm
- 2 Valve balls
- 1 Sealing set, complete

Scope of delivery with PVT material version

- 1 Diaphragm
- 1 Suction valve, complete
- 1 Discharge valve, complete
- 2 Valve balls
- 1 Sealing set, complete

Spare parts kits for Hydro/ 4

Identity code 250130, 250190, 250250, 250350, 250400

Liquid end	Materials in contact with the medium	Order no.
FMH 400 - DN 25	PVT	1043763
	PVT with valve	1023057
	SST	1040812
	SST with valve	1040813
	HCT	1040860

Identity code 160210, 160300, 160400, 160550, 160625

Liquid end	Materials in contact with the medium	Order no.
FMH 625 - DN 25	PVT	1043775
	PVT with valve	1040863
	SST	1040824
	SST with valve	1040825
	HCT	1040861

Identity code 100330, 100480, 100635, 100880, 101000

Liquid end	Materials in contact with the medium	Order no.
FMH 1000 - DN 32	PVT	1043776
	PVT with valve	1040866
	SST	1040826
	SST with valve	1040827
	HCT	1040864

Identity code 0704650, 070670, 070890, 071230, 071400

Liquid end	Materials in contact with the medium	Order no.
FMH 1400 - DN 40	PVT	1043777
	PVT with valve	1040869
	SST	1040828
	SST with valve	1040829
	HCT	1040867



2.6 Hydraulic Diaphragm Metering Pump Hydro/ 4

Metering Diaphragm PTFE/1.4404 for Hydro/ 4

Liquid end		Order no.
FMH 400	Identity code (SST) 250130, 250190, 250250, 250350, 250400	1040808
FMH 625	Identity code (SST) 160210, 160300, 160400, 160550, 160625	1040809
FMH 1000	Identity code (SST) 100330, 100480, 100635, 100880, 101000	1040810
FMH 1400	Identity code (SST) 0704650, 070670, 070890, 071230, 071400	1040811

Diaphragms PTFE/Hastelloy C Coated for Hydro/ 4

Liquid end		Order no.
FMH 400	Identity code (HCT) 250130, 250190, 250250, 250350, 250400	1040874
FMH 625	Identity code (HCT) 160210, 160300, 160400, 160550, 160625	1040875
FMH 1000	Identity code (HCT) 100330, 100480, 100635, 100880, 101000	1040876
FMH 1400	Identity code (HCT) 0704650, 070670, 070890, 071230, 071400	1040877

Base for Hydro hydraulic diaphragm metering pumps

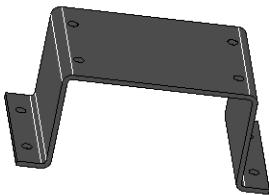

P_PZ_0010_SW1

	Order no.
Base for Hydro/ 4, dimensions: 344 x 250 x 120 mm (LxWxH)	1051421



2.7 Hydraulic Diaphragm Metering Pump Makro/ 5

2.7.1 Hydraulic Diaphragm Metering Pump Makro/ 5

Excellent feed rates in the low pressure range

Capacity range of single pump: 450 – 6,108 l/h, 25 – 6 bar

The robust hydraulic diaphragm metering pump Makro/ 5 guarantees outstanding process reliability. Its modular construction offers extremely good flexibility and a large range of power end versions are available.

The Makro/ 5 hydraulic diaphragm metering pump (M5Ha) together with the Makro/ 5 diaphragm and plunger metering pumps form an integrated product range with stroke lengths of 20 and/or 50 mm. This covers the capacity range from 38 to 6,108 l/h at 320 – 4 bar. A wide range of drive versions is available, including some for use in Exe and Exde areas with ATEX certification. The Makro/ 5 product range is designed to comply with API 675 among others.

Your benefits

Excellent process safety and reliability:

- PTFE multi-layer diaphragm with integral diaphragm rupture warning system
- Integral hydraulic relief valve
- Metering reproducibility is better than $\pm 1\%$ within the 10-100% stroke length range under defined conditions and with correct installation.

Excellent flexibility:

- The modular construction with single and double head versions permits a wide range of applications, with the double head designs being operated in push-pull mode
- It is possible to combine up to 4 metering units, even with different pump capacities, in multiple pump systems
- 5 different gear ratios are available
- Customised designs are available on request

Technical Details

- Stroke length: 0 – 50 mm, Rod force: 10,000 N
- Stroke length adjustment range: 0 – 100%
- Stroke length adjustment: manually by means of a manual adjustment wheel and scaled display (optionally with electric actuator or control drive)
- Metering reproducibility is better than $\pm 1\%$ within the 10 – 100% stroke length range under defined conditions and with correct installation
- PTFE multi-layer diaphragm with electrical diaphragm rupture warning system via a contact
- Integrated hydraulic relief and bleed valve
- Wetted materials: PVDF, PTFE+25% carbon, stainless steel 1.4571, special materials are available on request
- A wide range of power end versions is available: three-phase standard motors, motors for use in Exe and Exde areas and different flange designs for use in customer-specific motors
- Degree of protection: IP 55
- Design in compliance with API 675 among others

Field of application

- Oil and gas industry.
- Volume-proportional metering of chemicals/additives in the treatment of boiler feed water
- Metering of reactants and catalysts in the chemical industry
- Level-dependent metering of auxiliary agents in industrial production engineering, for instance hot wax metering in the production of adhesive strips

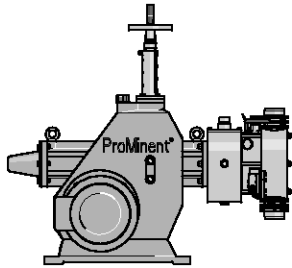

pk_2_096
Makro/ 5 M5Ha

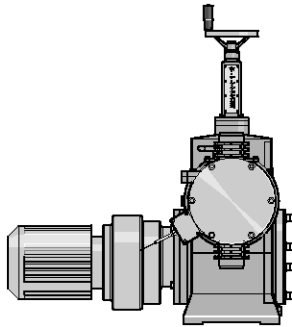

pk_2_097
Makro/ 5 M5Ha

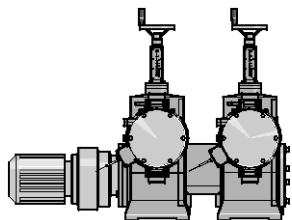

pk_2_094
Makro/ 5 externally mounted pump

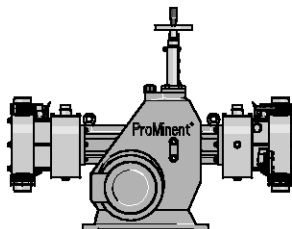

pk_2_092
Makro/ 5 double head pump



2.7 Hydraulic Diaphragm Metering Pump Makro/ 5

Control of Makro/5 Hydraulic Diaphragm Metering Pumps

Makro/ 5 stroke length controller

Control drive consisting of an actuator with servomotor and integral microprocessor controller for stroke length adjustment via a standard signal. Actuating period approx. 100 sec for 100% stroke length, including 2 limit switches for min./max. position, IP 54 degree of protection. Electrical connection 230 V ($\pm 10\%$), 50/60 Hz, 40 W mechanical stroke length display fitted on the Makro/ 5 power end.

Special voltage/higher degrees of protection/explosion protection on request.

Version with:

Standard signal current input 0/4-20 mA, corresponds to stroke length 0 - 100%; internal switch for manual /automatic operation, key switch for stroke adjustment in manual mode. Actual value output 0/4-20 mA for remote display.

Speed controllers with frequency converter (identity code specification Z)

The speed controller (complete) comprises a frequency converter and a variable speed motor (see also identity code specification R). The frequency converter is accommodated in an IP 55 rated protective housing with integral control unit and main switch, suitable for max. motor power 0.37/0.75/1.1 kW.

Externally controllable with 0/4-20 mA or 0-10 V corresponding to 0-50 (60) Hz output frequency.

Frequency Converters for Speed Control See page → 1-82

Stroke sensor with Namur signal

Mounting on the crank drive mechanism of the Makro/ 5 gearbox. For precise measurement of each metering stroke, comprising electronic cams and inductive proximity switches, switching signal according to Namur. In combination with electronic pre-selection meters suitable for batch metering or proportional metering in conjunction with proportional control.

Retrospective fitting only possible in the factory.

Approved for Ex safety operation with degree of protection EEx ia II C T6.

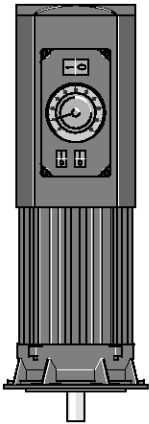

pk_2_103
Variable speed motor with integrated frequency converter

2.7 Hydraulic Diaphragm Metering Pump Makro/ 5

Technical Data

Type M5Ha	With 1500 rpm motor at 50 Hz				With 1800 rpm motor at 60 Hz				Suction lift m WC	Connection suction/ discharge side G-DN	Shipping weight kg	Plunger Ø mm
	Delivery rate at max. back pressure		Max. stroke rate Strokes/ min	Max. stroke rate Strokes/ min	Delivery rate at max. back pressure		Max. stroke rate Strokes/ min	Max. stroke rate Strokes/ min				
bar	l/h	ml/ stroke			psi	l/h			gph (US)			
250450	25	450	125.0	60	362	537	142	72	3.0	G 2-32	320	60
250562	25	562	125.0	75	362	671	177	89	3.0	G 2-32	320	60
250772	25	772	125.0	103	362	922	244	123	3.0	G 2-32	320	60
250997	25	997	125.0	133	362	1,191	315	159	3.0	G 2-32	320	60
251170	25	1,170	125.0	156	-	-	-	-	-	G 2-32	320	60
160616	16	616	171.2	60	232	736	194	72	3.0	G 2 1/4-40	320	70
160770	16	770	171.2	75	232	920	243	89	3.0	G 2 1/4-40	320	70
161058	16	1,058	171.2	103	232	1,264	334	123	3.0	G 2 1/4-40	320	70
161366	16	1,366	171.2	133	232	1,633	431	159	3.0	G 2 1/4-40	320	70
161602	16	1,602	171.2	156	-	-	-	-	3.0	G 2 1/4-40	320	70
120716	12	716	199.0	60	174	855	226	72	3.0	G 2 1/4-40	320	75
120895	12	895	199.0	75	174	1,069	282	89	3.0	G 2 1/4-40	320	75
121229	12	1,229	199.0	103	174	1,469	388	123	3.0	G 2 1/4-40	320	75
121588	12	1,588	199.0	133	174	1,898	501	159	3.0	G 2 1/4-40	320	75
121862	12	1,862	199.0	156	-	-	-	-	3.0	G 2 1/4-40	320	75
120919	12	919	255.3	60	174	1,098	290	72	3.0	G 2 1/4-40	320	85
121148	12	1,148	255.3	75	174	1,372	362	89	3.0	G 2 1/4-40	320	85
121577	12	1,577	255.3	103	174	1,885	498	123	3.0	G 2 1/4-40	320	85
122037	12	2,037	255.3	133	174	2,435	643	159	3.0	G 2 1/4-40	320	85
122389	12	2,389	255.3	156	-	2,856	754	-	3.0	G 2 1/4-40	320	85
101345	10	1,345	374.0	60	145	1,607	425	72	3.0	G 2 3/4-50	330	100
101680	10	1,680	374.0	75	145	2,008	530	89	3.0	G 2 3/4-50	330	100
102310	10	2,310	374.0	103	145	2,761	729	123	3.0	G 2 3/4-50	330	100
102980	10	2,980	374.0	133	145	3,562	941	159	3.0	G 2 3/4-50	330	100
103500	10	3,500	374.0	156	-	-	-	-	3.0	G 2 3/4-50	330	100
062305	6	2,305	641.0	60	87	2,755	728	72	3.0	flange-65*	330	130
062880	6	2,880	641.0	75	87	3,443	910	89	3.0	flange-65*	330	130
063960	6	3,960	641.0	103	87	4,734	1,251	123	3.0	flange-65*	330	130
065110	6	5,110	641.0	133	87	6,108	1,614	159	3.0	flange-65*	330	130
066000	6	6,000	641.0	156	-	-	-	-	3.0	flange-65*	330	130

Material Version PPT/PCT/TTT max. 10 bar

* SST version with G 2 1/2" thread

Materials in Contact With the Medium

Dosing head	Suction/pressure valve	DN 32/DN50/DN65 plate valves			DN 40 plate valves				
		Seals	Valve plates/ valve springs	Valve seats	Seals	Valve plates	Valve seats		
PPT	Polypropylene	Polypropylene	PTFE	Hast. C	PTFE	PPE	EPDM	Hast. C	PTFE
PCT	PVC	PVC	PTFE	Hast. C	PTFE	PCA	Viton®	Hast. C	PTFE
TTT	PTFE with carbon	PTFE with carbon	PTFE	Hast. C	PTFE	TTT	PTFE	Hast. C	PTFE
SST	Stainless steel material no. 1.4571/1.4404	Stainless steel material no. 1.4571/1.4404	PTFE	Hast. C	PTFE	SST	PTFE	Hast. C	PTFE

Patented multi-layer diaphragm, vacuum-packed

Special designs available on request

Viton® is a registered trademark of DuPont Dow Elastomers





2.7 Hydraulic Diaphragm Metering Pump Makro/ 5

2.7.2 Identity Code Ordering System for M5Ha

Motor-driven metering pump M5Ha

M5Ha	Drive type					
H	Main drive					
A	Add-on power end					
D	Double main drive					
B	Double add-on power end					
Type*						
250450	160616	120716	120919	101345	062305	
250562	160770	120895	121148	101680	062880	
250772	161058	121229	121577	102310	063960	
250997	161366	121588	122037	102980	065110	
251170	161602	121862	122389	103500	066000	
Liquid end material						
PC	PVC					
PP	Polypropylene					
SS	Stainless steel					
TT	PTFE + 25% carbon					
Sealing material						
T	PTFE					
Displacement body						
T	Composite diaphragm, PTFE coating, with rupture indicator					
Liquid end version						
1	With valve springs					
Hydraulic connection						
0	Standard connection					
1	PVC union nut and insert					
2	Union nut and insert PP					
3	PVDF union nut and insert					
4	SS union nut and insert					
Version						
0	with ProMinent® logo, no frame					
2	without ProMinent® logo, no frame					
A	with ProMinent® logo, with frame, simplex					
B	with ProMinent® logo, with frame, duplex					
C	with ProMinent® logo, with frame, triplex					
D	with ProMinent® logo, with frame, quadruplex					
M	Modified					
Electrical power supply						
S	3 ph. 230/400 V 50/60 Hz (WBS)					
R	Variable speed motor 4-pole, 230/400 V					
V (0)	Motor with integr. frequency converter					
L	3 ph. 230/400 V 50 Hz (Exe, Exd)					
P	3 ph. 230/400 V 60 Hz (Exe, Exd)					
V (2)	Motor with integr. frequency converter (Exd)					
5	No motor, with gearbox IEC 100					
6	No motor, with gearbox IEC 112					
0	No motor, no gearbox					
Enclosure rating						
0	IP 55 (Standard) ISO class F					
1	Exe version ATEX-T3					
2	Exd version ATEX-T4					
A	ATEX power end					
Stroke sensor						
0	No stroke sensor					
1	With stroke sensor (Namur)					
Stroke length adjustment						
0	Stroke length adjustment, manual					
3	230 V 0-20 mA stroke controller					
4	230 V 4-20 mA stroke controller					
5	115 V 0-20 mA stroke controller					
6	115 V 4-20 mA stroke controller					
Application						
0	Standard					
3	Low temperature -20 °C					

* Material version PC/PP/TT max. 10 bar

2.7 Hydraulic Diaphragm Metering Pump Makro/ 5

Motor Data

Identity code specification		Power supply			Remarks
S	3 ph, IP 55	220-240 V/380-420 V 250-280 V/440-480 V	50 Hz 60 Hz	3 kW	
R	3 ph, IP 55	230 V/400 V	50/60 Hz	3 kW	With PTC, speed control range 1:5
V0	3 ph, IP 55	400 V ±10%	50/60 Hz	3 kW	Variable speed motor with integrated frequency converter
L1	3 ph, II2GEEexIIIT3	220-240 V/380-420 V	50 Hz	3.6 kW	
L2	3 ph, II2GEEexdIIICT4	220-240 V/380-420 V	50 Hz	4 kW	With PTC, speed control range 1:5
P1	3 ph, II2GEEexIIIT3	250-280 V/440-480 V	60 Hz	3.6 kW	
P2	3 ph, II2GEEexdIIICT4	250-280 V/440-480 V	60 Hz	4 kW	With PTC, speed control range 1:5
V2	3 ph, II2GEEexIIICT4	400 V ±10%	50/60 Hz	4 kW	Ex-variable speed motor with integrated frequency converter

Motor data sheets can be requested for more information. Motors for Sigma basic pumps, special motors or special motor flanges are available on request.

The motors are designed in compliance with the Ecodesign Directive 2009/125/EC.

Information for use in areas at risk from explosion

Only use pumps with the appropriate labelling in line with the ATEX Directive 94/9/EC in premises at risk from explosion. Ensure that the explosion group, category and degree of protection specified on the label corresponds to or is better than the conditions prevalent in the intended field of application.



2.7 Hydraulic Diaphragm Metering Pump Makro/ 5

2.7.3 Spare Parts

The spare parts kits generally contain the consumable components for the liquid ends.

- 1 metering diaphragm
- 1 suction valve set
- 1 discharge valve set
- 1 seal set (O-rings, packing rings, valve seat, valve seat housings)

Spare Parts Kits for Makro/ 5 HMH

Identity code: 250450, 250562, 250772, 250997, 251170

Liquid end	Materials in contact with the medium	Order no.
FMH 60-50	S with 2 valves cpl.	1008170
	S without valves cpl.	1008169

Identity code: 160616, 160770, 161058, 161366, 161602, 120716, 120895, 121229, 121588, 121862, 120919, 121148, 121577, 122037, 122389

Liquid end	Materials in contact with the medium	Order no.
FMH 70/75/85-50	PPT	911904
	PCT	911902
	TTT	911906
	SST	911910
	SST without valves cpl.	911909

Identity code: 101345, 101680, 102310, 102980, 103500

Liquid end	Materials in contact with the medium	Order no.
FMH 100-50	PP	1008246
	P	1008247
	T	1008248
	S with valves cpl.	1008250
	S without valves cpl.	1008249

Identity code: 062305, 062880, 063960, 065110, 066000

Liquid end	Materials in contact with the medium	Order no.
FMH 130-50	PP	1008251
	P	1008252
	T	1008253
	S with valves cpl.	1008265
	S without valves cpl.	1008264

Metering Diaphragms for Makro/ 5 HMH

Liquid end	Order no.
FMH 60/70/75/85-50	1007298
FMH 100/130-50	1007852

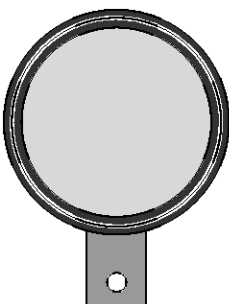

pk_2_024



2.8 Hydraulic Diaphragm Metering Pump Orlita® Evolution 1

2.8.1

Hydraulic Diaphragm Metering Pump Orlita® Evolution 1

Maximum process reliability and flexibility.

Capacity range of single pump: 3 – 511 l/h; 400 – 8 bar



The Orlita® Evolution 1 meets the highest safety requirements as an extremely robust hydraulic diaphragm metering pump. It stands out, thanks to its PTFE multi-layer diaphragm with integral diaphragm rupture warning system and unique diaphragm position control. Its modular construction offers extremely good flexibility in terms of applications.

The Orlita® Evolution hydraulic diaphragm metering pump range of EF1a, EF2a, EF3a and EF4a form an integrated product range with stroke lengths of 15 to 40 mm. This covers the capacity range of 3 to 7,400 l/h at 400 – 10 bar. A wide range of drive versions is available, including some with ATEX certification for use in Zone 1 or Zone 2 areas at risk from explosion. The Orlita® Evolution product range is designed to comply with API 675.

Your benefits

Maximum process reliability:

- PTFE multi-layer diaphragm with integral diaphragm rupture warning system
- Integral hydraulic relief valve
- The new diaphragm position control protects against operating faults (e. g. no damage in the event of a blockage on the suction or discharge side)
- Metering reproducibility is better than $\pm 1\%$ within the 10 – 100% stroke length range under defined conditions and with correct installation
- Continuous bleeding of the hydraulic oil chamber ensures reliable operation

Excellent flexibility:

- The modular compact construction with single and multiple pump versions allows for a wide range of applications, also for multiple pump systems, whereas up to 5 metering units, even with different pump capacities, can be combined.
- 7 different gear ratios are available
- Power end configuration ideal for installation in any position (vertical or horizontal)
- Customised designs are available on request

Technical Details

- Stroke length: 0 - 15 mm, rod force: 2,300 N
- Stroke length range: 0 – 100 %
- Stroke length adjustment: manually by means of a manual adjustment wheel and scaled display (optionally with electric actuator or control drive)
- Metering reproducibility is better than $\pm 1\%$ within the 10 – 100 % stroke length range under defined conditions and with correct installation
- PTFE multi-layer diaphragm with electrical diaphragm rupture warning system via a contact
- Integrated hydraulic relief and bleed valve
- Wetted materials:
Stainless steel 1.4404, special designs available on request
plastics PVC, PVDF, special designs available on request
- A wide range of power end versions is available: Three-phase standard motors also for use in Exe and Exde areas and different flange designs for use in customer-specific motors
- Degree of protection: IP 55
- Design in compliance with API 675 etc.

Field of application

- Oil and gas industry
- Metering of reactants and catalysts in the chemical industry
- Volume-proportional metering of chemicals/additives in the treatment of boiler feed water
- Level-dependent metering of auxiliary agents in industrial production engineering, for instance hot wax metering in the production of adhesive strips

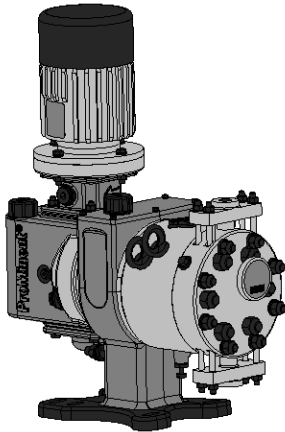

68_52-101_00_01-0a-Evo1_SW1
Orlita® Evolution EF1a

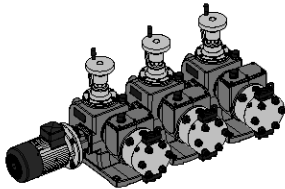

P_PZ_0008_SW1
Orlita® Evolution triplex pump



2.8 Hydraulic Diaphragm Metering Pump Orlita® Evolution 1

Technical data for EF1a single pump 50 Hz SST

Plunger Ø mm	Stroke volume ml/ stroke	Theoretical pump capacity in l/h at strokes/min (50 Hz)							Max. pressure bar	Efficiency at 100% pressure	Efficiency at 50% pressure	Standard type of valve
		73 [2] l/h	97 [3] l/h	116 [4] l/h	145 [5] l/h	165 [6] l/h	181 [7] l/h	201 [8] l/h				
8	0.75	3.3	4.4	5.2	6.6	7.5	8.2	9.1	400	0.43	0.69	DN 3
10	1.18	5.2	6.9	8.2	10.2	11.7	12.8	14.2	293	0.61	0.79	DN 3
12	1.70	7.4	9.9	11.8	14.8	16.8	18.4	20.5	203	0.77	0.86	DN 3
14	2.31	10.1	13.4	16.1	20.1	22.9	25.1	27.8	149	0.62	0.80	DN 6
17	3.40	14.9	19.8	23.7	29.6	33.7	36.9	41.0	101	0.77	0.88	DN 6
21	5.20	22.8	30.3	36.2	45.2	51.5	56.5	62.7	66	0.85	0.89	DN 10
25	7.36	32.2	42.8	51.2	64.0	72.9	79.9	88.8	47	0.90	0.93	DN 10
29	9.91	43.4	57.7	69.0	83.2	98.1	107.6	119.5	35	0.95	0.96	DN 10
32	12.06	52.8	70.2	83.9	104.9	119.4	131.0	145.4	29	0.89	0.93	DN 10
38	17.01	74.5	99.0	118.4	148.0	168.4	184.7	205.1	20	0.93	0.95	DN 10
44	22.81	99.9	132.8	158.8	198.4	225.8	247.7	275.1	15	0.94	0.96	DN 16
50	29.45	129.0	171.4	205.0	256.2	291.6	319.9	355.2	12	0.95	0.96	DN 16
58	39.63	173.6	230.6	275.8	344.8	392.3	430.4	477.9	9	0.95	0.97	DN 16

Technical data for EF1a single pump 60 Hz SST

Plunger Ø mm	Stroke volume ml/ stroke	Theoretical pump capacity in l/h at strokes/min (60 Hz)					Max. pressure bar	Efficiency at 100% pressure	Efficiency at 50% pressure	Standard type of valve
		88 [2] l/h	117 [3] l/h	140 [4] l/h	175 [5] l/h	199 [6] l/h				
8	0.75	4.0	5.3	6.3	7.9	9.0	400	0.43	0.69	DN 3
10	1.18	6.2	8.3	9.9	12.4	14.1	293	0.61	0.79	DN 3
12	1.70	9.0	11.9	14.3	17.8	20.3	203	0.77	0.86	DN 3
14	2.31	12.2	16.2	19.4	24.3	27.6	149	0.62	0.80	DN 6
17	3.40	18.0	23.9	28.6	35.7	40.6	101	0.77	0.88	DN 6
21	5.20	27.5	36.5	43.7	54.6	62.1	66	0.85	0.89	DN 10
25	7.36	38.9	51.7	61.8	77.3	87.9	47	0.90	0.93	DN 10
29	9.91	52.3	69.6	83.2	104.1	118.3	35	0.95	0.96	DN 10
32	12.06	63.7	84.7	101.3	126.6	144.0	29	0.89	0.93	DN 10
38	17.01	89.8	119.4	142.9	178.6	203.1	20	0.93	0.95	DN 10
44	22.81	120.4	160.1	191.6	239.5	272.4	15	0.94	0.96	DN 16
50	29.45	155.5	206.7	247.4	309.2	351.6	12	0.95	0.96	DN 16
58	39.63	209.2	278.2	332.9	416.1	473.2	9	0.95	0.97	DN 16

Note:

Abridged presentation of our complete product range. Other piston diameters (8–60 mm) on request

Materials in Contact With the Medium

Dosing head complete

Dosing head	Diaphragm retaining screw	Diaphragm
Stainless steel	Stainless steel 1.4462	PTFE multi-layer diaphragm

Ball valve DN 3 – DN 10

	Suction/pressure connector	Valve/head seal	Valve ball	Valve seat	Valve housing	Clamp ring
DN 3 (double ball)	Stainless steel 1.4404	Stainless steel 1.4404	Al ₂ O ₃ ceramic	Stainless steel 1.4404	Stainless steel 1.4404	Hastelloy C4
DN 6 (double ball)	Stainless steel 1.4404	Stainless steel 1.4404	SiN ceramic	Stainless steel 1.4404	Stainless steel 1.4404	Hastelloy C4
DN 10 (single ball)	Stainless steel 1.4404	Stainless steel 1.4404	Al ₂ O ₃ ceramic	Stainless steel 1.4404	Stainless steel 1.4404	Hastelloy C4

Plate valve DN 16

	Suction/pressure connector	Valve/head seal	Valve plate	Valve seat	Valve housing
DN 16	Stainless steel 1.4404	Stainless steel 1.4571	Stainless steel 1.4462	Stainless steel 1.4404	Stainless steel 1.4404

Further material versions and details available on request.

2.8 Hydraulic Diaphragm Metering Pump Orlita® Evolution 1

Technical data for EF1a single pump 50 Hz PVC/PVDF

Plunger Ø	Stroke volume	Theoretical pump capacity in l/h at strokes/min (50 Hz)							Max. pressure	Efficiency at 100% pressure	Efficiency at 50% pressure	Standard type of valve
		73 [2]	97 [3]	116 [4]	145 [5]	165 [6]	181 [7]	201 [8]				
mm	ml/stroke	l/h	l/h	l/h	l/h	l/h	l/h	l/h	bar			
8	0.75	3.3	4.4	5.2	6.6	7.5	8.2	9.1	16	0.65	0.70	DN 6
10	1.18	5.2	6.9	8.2	10.2	11.7	12.8	14.2	16	0.81	0.88	DN 6
12	1.70	7.4	9.9	11.8	14.8	16.8	18.5	20.5	16	0.79	0.82	DN 6
21	5.20	22.8	30.2	36.2	45.2	51.4	56.4	62.7	16	0.81	0.84	DN 10
25	7.36	32.3	42.9	51.2	64.1	72.9	80.0	88.8	16	0.84	0.87	DN 10
29	9.91	43.4	57.7	69.0	86.2	98.1	107.6	119.5	16	0.86	0.89	DN 10
44	22.81	99.9	132.8	158.8	198.4	225.8	247.7	275.1	10	0.94	0.96	DN 16
50	29.45	129.0	171.4	205.0	256.2	291.6	319.9	355.2	10	0.95	0.96	DN 16
60	42.41	185.8	246.8	295.2	369.0	419.9	460.6	511.5	8	0.96	0.97	DN 16

Technical data for EF1a single pump 60 Hz PVC/PVDF

Plunger Ø	Stroke volume	Theoretical pump capacity in l/h at strokes/min (60 Hz)					Max. pressure	Efficiency at 100% pressure	Efficiency at 50% pressure	Standard type of valve
		88 [2]	117 [3]	140 [4]	175 [5]	199 [6]				
mm	ml/stroke	l/h	l/h	l/h	l/h	l/h	bar			
8	0.75	4.0	5.3	6.3	7.9	9.0	16	0.65	0.70	DN 6
10	1.18	6.2	8.3	9.9	12.4	14.1	16	0.81	0.88	DN 6
12	1.70	9.0	11.9	14.3	17.9	20.3	16	0.79	0.82	DN 6
21	5.20	27.5	36.5	43.7	54.6	62.1	16	0.81	0.84	DN 10
25	7.36	38.9	51.7	61.8	77.3	87.9	16	0.84	0.87	DN 10
29	9.91	52.3	69.6	83.2	104.1	118.3	16	0.86	0.89	DN 10
44	22.81	120.4	160.1	191.6	239.5	272.4	10	0.94	0.96	DN 16
50	29.45	155.5	206.7	247.4	309.2	351.6	10	0.95	0.96	DN 16
60	42.41	223.9	297.7	356.2	445.3	506.4	8	0.96	0.97	DN 16

Note:

Abridged presentation of our complete product range. Other piston diameters (8 - 60 mm) on request. Other pressures (16 and/or 21 bar) on request.

Materials in Contact With the Medium

Dosing head complete

Dosing head	Diaphragm retaining screw	Diaphragm
PVC	Stainless steel 2.4610	PTFE
PVDF	Stainless steel 2.4610	PTFE

Ball valve DN 6 – DN 10

	Suction/pressure connector	Valve/head seal	Valve ball	Valve seat	Valve housing	Clamp ring
DN 6 (single ball)	PVDF	PTFE moulded composite	Al ₂ O ₃ ceramic	PTFE	PVDF	PVDF
DN 10 (single ball)	PVDF	PTFE moulded composite	Al ₂ O ₃ ceramic	PTFE	PVDF	PVDF

Plate valve DN 16

	Suction/pressure connector	Valve/head seal	Valve ball	Valve seat	Valve housing
DN 16	PVDF	PTFE	ZrO ₂ ceramic	PTFE	PVDF

Further material versions and details available on request.



2.9 Hydraulic Diaphragm Metering Pump Orlita® Evolution 2

2.9.1

Hydraulic Diaphragm Metering Pump Orlita® Evolution 2

Maximum process reliability and flexibility.

Capacity range of single pump: 6 – 900 l/h; 400 – 11 bar

The Orlita® Evolution 2 meets the highest safety requirements as an extremely robust hydraulic diaphragm metering pump. It stands out, thanks to its PTFE multi-layer diaphragm with integral diaphragm rupture warning system and unique diaphragm position control.

The Orlita® Evolution hydraulic diaphragm metering pump range of EF1a, EF2a, EF3a and EF4a form an integrated product range with stroke lengths of 15 to 40 mm. This covers the capacity range of 3 to 7,400 l/h at 400 – 10 bar. A wide range of drive versions is available, including some with ATEX certification for use in Zone 1 or Zone 2 areas at risk from explosion. The Orlita® Evolution product range is designed to comply with API 675.

Your benefits

Maximum process reliability:

- PTFE multi-layer diaphragm with integral diaphragm rupture warning system
- Integral hydraulic relief valve
- The new diaphragm position control protects against operating faults (e. g. no damage in the event of a blockage on the suction or discharge side)
- Metering reproducibility is better than $\pm 1\%$ within the 10 – 100% stroke length range under defined conditions and with correct installation
- Continuous bleeding of the hydraulic oil chamber ensures reliable operation

Excellent flexibility:

- The modular compact construction with single and multiple pump versions allows for a wide range of applications, also for multiple pump systems, whereas up to 5 metering units, even with different pump capacities, can be combined.
- 7 different gear ratios are available
- Power end configuration ideal for installation in any position (vertical or horizontal)
- Customised designs are available on request

Technical Details

- Stroke length: 0 - 15 mm, rod force: 5,400 N
- Stroke length range: 0 – 100 %
- Stroke length adjustment: manually by means of a manual adjustment wheel and scaled display (optionally with electric actuator or control drive)
- Metering reproducibility is better than $\pm 1\%$ within the 10 – 100 % stroke length range under defined conditions and with correct installation
- PTFE multi-layer diaphragm with electrical diaphragm rupture warning system via a contact
- Integrated hydraulic relief and bleed valve
- Wetted materials:
 - Stainless steel 1.4404, special designs available on request
 - plastics PVC, PVDF, special designs available on request
- A wide range of power end versions is available: Three-phase standard motors also for use in Exe and Exde areas and different flange designs for use in customer-specific motors
- Degree of protection: IP 55
- Design in compliance with API 675 etc.

Field of application

- Oil and gas industry
- Volume-proportional metering of chemicals/additives in the treatment of boiler feed water
- Metering of reactants and catalysts in the chemical industry
- Level-dependent metering of auxiliary agents in industrial production engineering, for instance hot wax metering in the production of adhesive strips

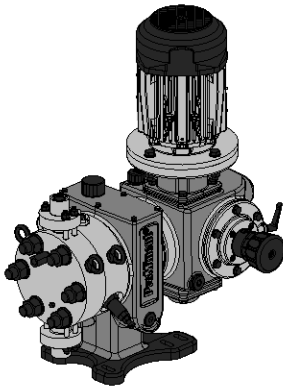

68_52-101_00_01-0a-Evo2_SW1
Orlita® Evolution EF2a

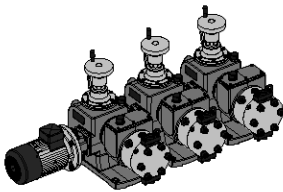

P_PZ_0008_SW1
Orlita® Evolution triplex pump



2.9 Hydraulic Diaphragm Metering Pump Orlita® Evolution 2

Technical data for EF2a single pump 50 Hz SST

Plunger Ø mm	Stroke volume ml/ stroke	Theoretical pump capacity in l/h at strokes/min (50 Hz)							Max. pressure bar	Efficiency at 100% pressure	Efficiency at 50% pressure	Standard type of valve
		73 [2] l/h	97 [3] l/h	116 [4] l/h	145 [5] l/h	165 [6] l/h	181 [7] l/h	201 [8] l/h				
12	1.70	7	10	12	15	17	18	21	400	0.69	0.82	DN 3
14	2.31	10	13	16	20	22	25	28	351	0.35	0.67	DN 6
17	3.40	15	20	24	30	34	37	41	238	0.60	0.79	DN 6
21	5.20	23	30	36	45	51	56	53	156	0.75	0.85	DN 10
25	7.36	32	43	51	64	73	80	89	110	0.83	0.89	DN 10
29	9.91	43	58	69	86	98	108	120	82	0.90	0.93	DN 10
32	12.06	53	70	84	105	119	131	145	67	0.76	0.87	DN 10
38	17.01	75	99	118	148	168	185	205	48	0.87	0.92	DN 10
44	22.81	100	133	159	198	226	248	275	36	0.90	0.94	DN 16
50	29.45	129	171	205	256	292	320	355	28	0.91	0.95	DN 16
58	39.63	174	231	276	345	392	430	478	20	0.93	0.96	DN 16
70	57.73	253	336	402	502	572	627	696	14	0.94	0.96	DN 20

Technical data for EF2a single pump 60 Hz SST

Plunger Ø mm	Stroke volume ml/ stroke	Theoretical pump capacity in l/h at strokes/min (60 Hz)					Max. pressure bar	Efficiency at 100% pressure	Efficiency at 50% pressure	Standard type of valve
		88 [2] l/h	117 [3] l/h	140 [4] l/h	175 [5] l/h	199 [6] l/h				
12	1.70	9	12	14	18	20	400	0.69	0.82	DN 3
14	2.31	12	16	19	24	28	351	0.35	0.67	DN 6
17	3.40	18	24	29	36	41	238	0.60	0.79	DN 6
21	5.20	27	37	44	55	62	156	0.75	0.85	DN 10
25	7.36	39	52	62	77	88	110	0.83	0.89	DN 10
29	9.91	52	70	83	104	118	82	0.90	0.93	DN 10
32	12.06	64	85	101	127	144	67	0.76	0.87	DN 10
38	17.01	90	119	143	179	203	48	0.87	0.92	DN 10
44	22.81	120	160	192	240	272	36	0.90	0.94	DN 16
50	29.45	155	207	247	309	352	28	0.91	0.95	DN 16
58	39.63	209	278	333	416	473	20	0.93	0.96	DN 16
70	57.73	305	405	485	606	689	14	0.94	0.96	DN 20

Note:

Abridged presentation of our complete product range. Other piston diameters (11 – 80 mm) on request.

Materials in Contact With the Medium

Dosing head complete

Dosing head	Diaphragm retaining screw	Diaphragm
Stainless steel 1.4404	Stainless steel 1.4462	PTFE multi-layer diaphragm

Ball valve DN 3 – DN 10

	Suction/pressure connector	Valve/head seal	Valve ball	Valve seat	Valve housing	Clamp ring
DN 3 (double ball)	Stainless steel 1.4404	Stainless steel 1.4404	Al ₂ O ₃ ceramic	Stainless steel 1.4404	Stainless steel 1.4404	Hastelloy C4
DN 6 (double ball)	Stainless steel 1.4404	Stainless steel 1.4404	SiN ceramic	Stainless steel 1.4404	Stainless steel 1.4404	Hastelloy C4
DN 10 (double ball)	Stainless steel 1.4404	Stainless steel 1.4404	Al ₂ O ₃ ceramic	Stainless steel 1.4404	Stainless steel 1.4404	Hastelloy C4

Plate valve DN 16 – DN 20

	Suction/pressure connector	Valve/head seal	Valve plate	Valve seat	Valve housing
DN 16/DN 20	Stainless steel 1.4404	Stainless steel 1.4571	Stainless steel 1.4462	Stainless steel 1.4404	Stainless steel 1.4404

Further material versions and details available on request.





2.9 Hydraulic Diaphragm Metering Pump Orlita® Evolution 2

Technical data for EF2a single pump 50 Hz PVC/PVDF

Plunger Ø	Stroke volume	Theoretical pump capacity in l/h at strokes/min (50 Hz)							Max. pressure	Efficiency at 100% pressure	Efficiency at 50% pressure	Standard type of valve
		73 [2] l/h	97 [3] l/h	116 [4] l/h	145 [5] l/h	165 [6] l/h	181 [7] l/h	201 [8] l/h				
mm	ml/ stroke								bar			
11	1.43	6	8	10	12	14	16	17	16	0.66	0.72	DN 6
12	1.70	7	10	12	15	17	18	21	16	0.79	0.82	DN 6
21	5.20	23	30	36	45	51	56	63	16	0.81	0.84	DN 10
25	7.36	32	43	51	64	73	80	89	16	0.84	0.87	DN 10
29	9.91	43	58	69	86	98	108	120	16	0.86	0.89	DN 10
44	22.81	100	133	159	198	226	248	275	10	0.94	0.96	DN 16
50	29.45	129	171	205	256	292	320	355	10	0.95	0.96	DN 16
60	42.41	186	247	295	369	420	460	511	8	0.96	0.97	DN 16

Technical data for EF2a single pump 60 Hz PVC/PVDF

Plunger Ø	Stroke volume	Theoretical pump capacity in l/h at strokes/min (60 Hz)					Max. pressure	Efficiency at 100% pressure	Efficiency at 50% pressure	Standard type of valve
		88 [2] l/h	117 [3] l/h	140 [4] l/h	175 [5] l/h	199 [6] l/h				
mm	ml/ stroke						bar			
11	1.43	8	10	12	15	17	16	0.66	0.72	DN 6
12	1.70	9	12	14	18	20	16	0.79	0.82	DN 6
21	5.20	27	37	44	55	62	16	0.81	0.84	DN 10
25	7.36	39	52	62	77	88	16	0.84	0.87	DN 10
29	9.91	52	70	83	104	118	16	0.86	0.89	DN 10
44	22.81	120	160	192	240	272	10	0.94	0.96	DN 16
50	29.45	155	207	247	309	352	10	0.95	0.96	DN 16
60	42.41	224	298	356	445	506	8	0.96	0.97	DN 16

Note:

Abridged presentation of our complete product range. Other piston diameters on request. Other pressure stages (e.g. 21 bar) on request.

Materials in Contact With the Medium

Dosing head complete

Dosing head	Diaphragm retaining screw	Diaphragm
PVC	Stainless steel 2.4610	PTFE
PVDF	Stainless steel 2.4610	PTFE

Ball valve DN 6 – DN 10

	Suction/pressure connector	Valve/head seal	Valve ball	Valve seat	Valve housing	Clamp ring
DN 6 (single ball)	PVDF	PTFE moulded composite	Al ₂ O ₃ ceramic	PTFE	PVDF	PVDF
DN 10 (single ball)	PVDF	PTFE moulded composite	Al ₂ O ₃ ceramic	PTFE	PVDF	PVDF

Plate valve DN 16

	Suction/pressure connector	Valve/head seal	Valve plate	Valve seat	Valve housing
DN 16	PVDF	PTFE	ZrO ₂ ceramic	PTFE	PVDF

Further material versions and details available on request.

2.10 Hydraulic Diaphragm Metering Pump Orlita® Evolution 3

2.10.1

Hydraulic Diaphragm Metering Pump Orlita® Evolution 3

Maximum process reliability and flexibility.

Capacity range of single pump: 21 – 1,330 l/h, 400 – 18 bar



The Orlita® Evolution 3 meets the highest safety requirements as an extremely robust hydraulic diaphragm metering pump. It stands out, thanks to its PTFE multi-layer diaphragm with integral diaphragm rupture warning system and unique diaphragm position control.

The Orlita® Evolution hydraulic diaphragm metering pump range of EF1a, EF2a, EF3a and EF4a form an integrated product range with stroke lengths of 15 to 40 mm. This covers the capacity range of 3 to 7,400 l/h at 400 – 10 bar. A wide range of drive versions is available, including some with ATEX certification for use in Zone 1 or Zone 2 areas at risk from explosion. The Orlita® Evolution product range is designed to comply with API 675.

Your benefits

Maximum process reliability:

- PTFE multi-layer diaphragm with integral diaphragm rupture warning system
- Integral hydraulic relief valve
- The new diaphragm layer control protects against impermissible operating statuses (e.g. no damage in the event of a blockage on the suction or discharge side)
- Continuous bleeding of the oil chamber ensures reliable operation

Excellent flexibility:

- The modular construction with single and multiple pump versions permits a wide range of applications. In multiple pump systems up to 5 metering units can be combined, including units with different pump capacities
- 7 different gear ratios are available; in single pumps the drive arrangement can be either vertical or horizontal
- Customised designs are available on request

Technical Details

- Stroke length: 0 - 25 mm, rod force: 8,000 N
- Stroke length range: 0 – 100 %
- Stroke length adjustment: manually by means of a manual adjustment wheel and scaled display (optionally with electric actuator or control drive)
- Metering reproducibility is better than ± 1 % within the 10 – 100 % stroke length range under defined conditions and with correct installation
- PTFE multi-layer diaphragm with electrical diaphragm rupture warning system via a contact
- Integrated hydraulic relief and bleed valve
- Wetted materials:
Stainless steel 1.4404, special designs available on request
plastics PVC, PVDF, special designs available on request
- A wide range of power end versions is available: Three-phase standard motors also for use in Exe and Exde areas and different flange designs for use in customer-specific motors
- Degree of protection: IP 55
- Design in compliance with API 675 etc.

Field of application

- Oil and gas industry
- Volume-proportional metering of chemicals/additives in the treatment of boiler feed water
- Metering of reactants and catalysts in the chemical industry
- Level-dependent metering of auxiliary agents in industrial production engineering, for instance hot wax metering in the production of adhesive strips

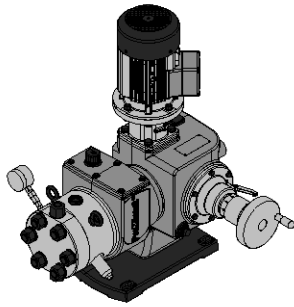

P_ORL_063_SW1
Orlita® Evolution EF3a

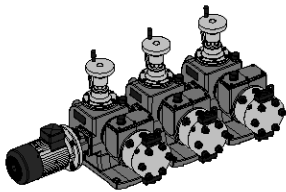

P_PZ_0008_SW1
Orlita® Evolution triplex pump



2.10 Hydraulic Diaphragm Metering Pump Orlita® Evolution 3

Technical data for EF3a single pump 50 Hz SST

Plunger Ø mm	Stroke volume ml/ stroke	Theoretical pump capacity in l/h at strokes/min (50 Hz)							Max. pressure bar	Efficiency at 100% pressure	Efficiency at 50% pressure	Standard type of valve
		73 [2] l/h	97 [3] l/h	116 [4] l/h	145 [5] l/h	165 [6] l/h	181 [7] l/h	201 [8] l/h				
17	5.67	24	32	39	49	56	61	68	352	0.68	0.83	DN 6
22	9.50	41	55	66	82	93	103	114	210	0.87	0.93	DN 6
25	12.27	53	71	85	106	121	133	148	163	0.86	0.92	DN 10
30	17.67	77	102	123	174	192	192	213	113	0.92	0.95	DN 10
34	22.70	99	132	158	197	225	247	274	88	0.90	0.94	DN 16
38	28.35	123	164	197	247	280	308	343	71	0.93	0.95	DN 16
44	38.01	165	220	265	331	376	413	459	53	0.95	0.97	DN 20
50	49.09	214	285	342	427	485	534	593	41	0.97	0.98	DN 20
58	66.05	287	383	460	575	653	718	798	30	0.98	0.99	DN 20
63	77.93	341	454	542	678	772	846	940	26	0.97	0.98	DN 25
70	96.21	419	558	670	837	951	1,046	1,163	21	0.98	0.98	DN 25
75	110.45	480	640	768	960	1,091	1,201	1,334	18	0.98	0.98	DN 25

Technical data for EF3a single pump 60 Hz SST

Plunger Ø mm	Stroke volume ml/ stroke	Theoretical pump capacity in l/h at strokes/min (60 Hz)					Max. pressure bar	Efficiency at 100% pressure	Efficiency at 50% pressure	Standard type of valve
		88 [2] l/h	117 [3] l/h	140 [4] l/h	175 [5] l/h	199 [6] l/h				
17	5.67	29	39	47	59	67	352	0.68	0.83	DN 6
22	9.50	50	67	80	100	113	210	0.87	0.93	DN 6
25	12.27	64	86	103	129	146	163	0.86	0.92	DN 10
30	17.67	93	124	148	186	211	113	0.92	0.95	DN 10
34	22.70	120	159	191	238	271	88	0.90	0.94	DN 16
38	28.35	149	198	238	298	338	71	0.93	0.95	DN 16
44	38.01	200	266	319	399	454	53	0.95	0.97	DN 20
50	49.09	258	344	412	515	585	41	0.97	0.98	DN 20
58	66.05	347	462	555	694	788	30	0.98	0.99	DN 20
63	77.93	411	547	655	818	930	26	0.97	0.98	DN 25
70	96.21	505	673	808	1,010	1,148	21	0.98	0.98	DN 25
75	110.45	580	773	927	1,159	1,317	18	0.98	0.98	DN 25

Note:

Abridged presentation of our complete product range. Other piston diameters (14 - 75 mm) on request

Materials in Contact With the Medium

Dosing head complete

Dosing head	Diaphragm retaining screw	Diaphragm
Stainless steel 1.4404	Stainless steel 1.4462	PTFE multi-layer diaphragm

Ball valve DN 6 – DN 10

	Suction/pressure connector	Valve/head seal	Valve ball	Valve seat	Valve housing	Clamp ring
DN 6 (double ball)	Stainless steel 1.4404	Stainless steel 1.4404	SIN ceramic	Stainless steel 1.4404	Stainless steel 1.4404	Hastelloy C4
DN 10 (single ball)	Stainless steel 1.4404	Stainless steel 1.4404	Al ₂ O ₃ ceramic	Stainless steel 1.4404	Stainless steel 1.4404	Hastelloy C4

Plate valve DN 16 – DN 25

	Suction/pressure connector	Valve/head seal	Valve plate	Valve seat	Valve housing
DN 16/DN 25	Stainless steel 1.4404	Stainless steel 1.4571	Stainless steel 1.4462	Stainless steel 1.4404	Stainless steel 1.4404

Further material versions and details available on request.

2.10 Hydraulic Diaphragm Metering Pump Orlita® Evolution 3

Technical data for EF3a single pump 50 Hz PVC/PVDF

Plunger Ø	Stroke volume	Theoretical pump capacity in l/h at strokes/min (50 Hz)							Max. pressure	Efficiency at 100% pressure	Efficiency at 50% pressure	Standard type of valve
		73 [2]	97 [3]	116 [4]	145 [5]	165 [6]	181 [7]	201 [8]				
mm	ml/stroke	l/h	l/h	l/h	l/h	l/h	l/h	l/h	bar			
63	77.93	339	452	542	678	770	848	942	10	0.95	0.96	DN 25
67	88.14	386	513	613	767	873	957	1,063	10	0.95	0.96	DN 25
70	96.21	419	558	670	837	951	1,046	1,163	10	0.96	0.97	DN 25
75	110.45	480	641	769	961	1,092	1,201	1,335	10	0.97	0.98	DN 25

Technical data for EF3a single pump 60 Hz PVC/PVDF

Plunger Ø	Stroke volume	Theoretical pump capacity in l/h at strokes/min (60 Hz)					Max. pressure	Efficiency at 100% pressure	Efficiency at 50% pressure	Standard type of valve
		88 [2]	117 [3]	140 [4]	175 [5]	199 [6]				
mm	ml/stroke	l/h	l/h	l/h	l/h	l/h	bar			
63	77.93	409	546	655	818	930	10	0.95	0.96	DN 25
75	110.45	583	775	928	1,160	1,319	10	0.97	0.98	DN 25
67	88.14	465	619	740	925	1,052	10	0.95	0.96	DN 25
70	96.21	505	673	808	1,010	1,148	10	0.96	0.97	DN 25

Note:

Abridged presentation of our complete product range. Other piston diameters on request. Other pressure stages (e.g. 16 bar) on request.

Materials in Contact With the Medium

Dosing head complete

Dosing head	Diaphragm retaining screw	Diaphragm
PVC	2.4610	PTFE
PVDF	2.4610	PTFE

Plate valve

	Suction/pressure connector	Valve/head seal	Valve plate	Valve seat	Valve housing
DN 25	PVDF	PTFE	ZrO ₂ ceramic	PTFE	PVDF

Further material versions and details available on request.



2.11 Hydraulic Diaphragm Metering Pump Orlita® Evolution 4

2.11.1

Hydraulic Diaphragm Metering Pump Orlita® Evolution 4

Maximum process reliability and flexibility.

Capacity range of single pump: 55 – 7,400 l/h, 400 – 10 bar

The Orlita® Evolution 4 meets the highest safety requirements as an extremely robust hydraulic diaphragm metering pump. It stands out, thanks to its PTFE multi-layer diaphragm with integral diaphragm rupture warning system and unique diaphragm position control.

The Orlita® Evolution hydraulic diaphragm metering pump range of EF1a, EF2a, EF3a and EF4a form an integrated product range with stroke lengths of 15 to 40 mm. This covers the capacity range of 3 to 7,400 l/h at 400 – 10 bar. A wide range of drive versions is available, including some with ATEX certification for use in Zone 1 or Zone 2 areas at risk from explosion. The Orlita® Evolution product range is designed to comply with API 675.

Your benefits

Maximum process reliability:

- PTFE multi-layer diaphragm with integral diaphragm rupture warning system
- Integral hydraulic relief valve
- The new diaphragm position control protects against operating faults (e. g. no damage in the event of a blockage on the suction or discharge side)
- Metering reproducibility is better than $\pm 1\%$ within the 10 – 100% stroke length range under defined conditions and with correct installation
- Continuous bleeding of the hydraulic oil chamber ensures reliable operation

Excellent flexibility:

- The modular compact construction with single and multiple pump versions allows for a wide range of applications, also for multiple pump systems, whereas up to 5 metering units, even with different pump capacities, can be combined.
- 7 different gear ratios are available
- Power end configuration ideal for installation in any position (vertical or horizontal)
- Customised designs are available on request

Technical Details

- Stroke length: 0 - 40 mm, rod force: 15,700 N
- Stroke length range: 0 – 100 %
- Stroke length adjustment: manually by means of a manual adjustment wheel and scaled display (optionally with electric actuator or control drive)
- Metering reproducibility is better than $\pm 1\%$ within the 10 – 100 % stroke length range under defined conditions and with correct installation
- PTFE multi-layer diaphragm with electrical diaphragm rupture warning system via a contact
- Integrated hydraulic relief and bleed valve
- Wetted materials:
 - Stainless steel 1.4404, special designs available on request
 - plastics PVC, PVDF, special designs available on request
- A wide range of power end versions is available: Three-phase standard motors also for use in Exe and Exde areas and different flange designs for use in customer-specific motors
- Degree of protection: IP 55
- Design in compliance with API 675 etc.

Field of application

- Oil and gas industry
- Volume-proportional metering of chemicals/additives in the treatment of boiler feed water
- Metering of reactants and catalysts in the chemical industry
- Level-dependent metering of auxiliary agents in industrial production engineering, for instance hot wax metering in the production of adhesive strips

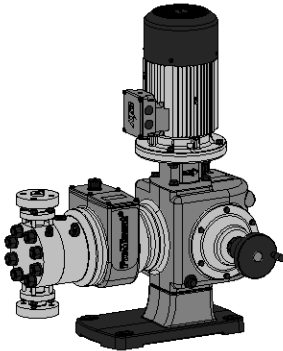

68_54-101_00_03-0a-Evo4_SW1
Orlita® Evolution EF4a

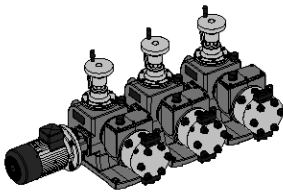

P_PZ_0008_SW1
Orlita® Evolution triplex pump



2.11 Hydraulic Diaphragm Metering Pump Orlita® Evolution 4

Technical data for EF4a single pump 50 Hz SST

Plunger Ø mm	Stroke volume ml/ stroke	Theoretical pump capacity in l/h at strokes/min (50 Hz)							Max. pressure bar	Efficiency at 100% pressure	Efficiency at 50% pressure	Standard type of valve
		73 [2] l/h	97 [3] l/h	116 [4] l/h	145 [5] l/h	165 [6] l/h	181 [7] l/h	201 [8] l/h				
22	15.21	67	89	106	132	151	165	183	400	0.71	0.84	DN 16
25	19.63	86	114	137	171	194	213	237	320	0.72	0.85	DN 16
30	28.27	124	165	197	246	280	307	341	222	0.73	0.85	DN 16
34	36.32	159	211	253	316	360	394	438	172	0.80	0.87	DN 16
38	45.36	199	264	316	395	449	493	547	138	0.86	0.90	DN 20
44	60.82	266	354	423	529	602	661	733	103	0.90	0.92	DN 20
50	78.54	344	457	547	683	778	853	947	80	0.93	0.94	DN 32
60	113.10	495	658	787	984	1,120	1,228	1,364	55	0.94	0.95	DN 32
70	153.94	674	896	1,071	1,339	1,524	1,672	1,857	40	0.94	0.95	DN 40
75	176.71	774	1,028	1,230	1,537	1,749	1,919	2,131	35	0.95	0.96	DN 40
86	232.35	1,018	1,352	1,617	2,021	2,300	2,523	2,802	27	0.96	0.97	DN 50
90	254.47	1,115	1,481	1,771	2,214	2,519	2,764	3,069	24	0.96	0.97	DN 50
100	314.16	1,376	1,828	2,187	2,733	3,110	3,412	3,789	20	0.97	0.98	DN 50
110	380.13	1,665	2,212	2,646	3,307	3,763	4,128	4,584	16	0.98	0.98	DN 50
115	415.48	1,820	2,418	2,892	3,615	4,113	4,512	5,011	15	0.98	0.99	DN 65
130	530.93	2,325	3,090	3,695	4,619	5,256	5,766	6,403	12	0.99	0.99	DN 65
140	615.75	2,697	3,584	4,286	5,357	6,096	6,687	7,426	10	0.99	0.99	DN 65

Technical data for EF4a single pump 60 Hz SST

Plunger Ø mm	Stroke volume ml/ stroke	Theoretical pump capacity in l/h at strokes/min (60 Hz)					Max. pressure bar	Efficiency at 100% pressure	Efficiency at 50% pressure	Standard type of valve
		88 [2] l/h	117 [3] l/h	140 [4] l/h	175 [5] l/h	199 [6] l/h				
22	15.21	80	107	128	160	182	400	0.71	0.84	DN 16
25	19.63	104	138	165	206	234	320	0.72	0.85	DN 16
30	28.27	149	198	237	297	337	222	0.73	0.85	DN 16
34	36.32	192	255	305	381	434	172	0.80	0.87	DN 16
38	45.36	240	318	381	476	542	138	0.86	0.90	DN 20
44	60.82	321	427	511	639	726	103	0.90	0.92	DN 20
50	78.54	415	551	660	825	938	80	0.93	0.94	DN 32
60	113.10	597	794	950	1,188	1,350	55	0.94	0.95	DN 32
70	153.94	813	1,081	1,293	1,616	1,838	40	0.94	0.95	DN 40
75	176.71	933	1,241	1,484	1,855	2,110	35	0.95	0.96	DN 40
86	232.35	1,227	1,631	1,952	2,440	2,774	27	0.96	0.97	DN 50
90	254.47	1,344	1,786	2,138	2,671	3,038	24	0.96	0.97	DN 50
100	314.16	1,659	2,205	2,639	3,299	3,751	20	0.97	0.98	DN 50
110	380.13	2,007	2,669	3,193	3,991	4,539	16	0.98	0.98	DN 50
115	415.48	2,194	2,917	3,490	4,363	4,961	15	0.98	0.99	DN 65
130	530.93	2,803	3,727	4,460	5,575	6,339	12	0.99	0.99	DN 65
140	615.75	3,251	4,323	5,172	6,465	7,352	10	0.99	0.99	DN 65

Note:

Abridged presentation of our complete product range. Other piston diameters (14 - 75 mm) on request

Materials in Contact With the Medium

Dosing head complete

Dosing head	Diaphragm retaining screw	Diaphragm
Stainless steel 1.4404	Stainless steel 1.4462	PTFE multi-layer diaphragm

Plate valve

	Suction/ pressure connector	Valve/ head seal	Valve plate	Valve seat	Valve housing
DN 16 – DN 65	Stainless steel 1.4404	Stainless steel 1.4571	Stainless steel 1.4462	Stainless steel 1.4404	Stainless steel 1.4404

Further material versions and details available on request.





2.11 Hydraulic Diaphragm Metering Pump Orlita® Evolution 4

Technical data for EF4a single pump 50 Hz PVC/PVDF

Plunger Ø	Stroke volume	Theoretical pump capacity in l/h at strokes/min (50 Hz)							Max. pressure	Efficiency at 100% pressure	Efficiency at 50% pressure	Standard type of valve
		73 [2] l/h	97 [3] l/h	116 [4] l/h	145 [5] l/h	165 [6] l/h	181 [7] l/h	201 [8] l/h				
mm	ml/stroke								bar			
70	153.94	674	896	1,071	1,339	1,524	1,672	1,857	10	0.94	0.95	DN 40
86	232.35	1,018	1,352	1,617	2,021	2,300	2,523	2,802	10	0.96	0.97	DN 50
110	380.13	1,665	2,212	2,646	3,307	3,763	4,128	4,584	10	0.98	0.98	DN 50
140	615.75	2,697	3,584	4,286	5,357	6,096	6,687	7,426	10	0.99	0.99	DN 65

Technical data for EF4a single pump 60 Hz PVC/PVDF

Plunger Ø	Stroke volume	Theoretical pump capacity in l/h at strokes/min (60 Hz)					Max. pressure	Efficiency at 100% pressure	Efficiency at 50% pressure	Standard type of valve
		88 [2] l/h	117 [3] l/h	140 [4] l/h	175 [5] l/h	199 [6] l/h				
mm	ml/stroke						bar			
70	153.94	813	1,081	1,293	1,616	1,838	10	0.94	0.95	DN 40
86	232.35	1,227	1,631	1,952	2,440	2,523	10	0.96	0.97	DN 50
110	380.13	2,007	2,669	3,193	3,991	4,539	10	0.98	0.98	DN 50
140	615.75	3,251	4,323	5,172	6,465	7,352	10	0.99	0.99	DN 65

Note:

Abridged presentation of our complete product range. Other piston diameters on request. Other pressure stages (16 and/or 21 bar) on request.

Materials in Contact With the Medium

Dosing head complete

Dosing head	Diaphragm retaining screw	Diaphragm
PVC	2.4610	PTFE
PVDF	2.4610	PTFE

Plate valve

	Suction/pressure connector	Valve/head seal	Valve plate	Valve seat	Valve housing
DN 40 – DN 65	PVDF	PTFE	ZrO ₂ ceramic	PTFE	PVDF

Further material versions and details available on request.

2.12 Hydraulic Diaphragm Metering Pumps Orlita® MF

2.12.1

Hydraulic Diaphragm Metering Pump Orlita® MF

Reliable capacity even at high pressure

Capacity range of single pump: 0 – 13,000 l/h, 700 – 6 bar

The hydraulic diaphragm metering pump Orlita® MF offers reliable capacities even under high pressure and has a modular construction, therefore has versatile uses. Thanks to its modular design, this pump is tailored to meet your requirements even at very high pump capacities.

ORLITA® MF hydraulic diaphragm metering pumps (MFS 18 to MFS 1400) with a stroke length of 15 to 60 mm provide a capacity ranging from 0 to 13,000 l/h at 700 – 6 bar. A wide range of drive versions is available, including some for use in Zone 1 or Zone 2 areas at risk from explosion with ATEX certification. The Orlita® MF product range is designed to comply with API 675. Its modular construction permits the free combination of drives, power ends and dosing heads, producing a pump for a range of different feed rates and media operating at different working pressures.

Your benefits

Excellent process safety and reliability:

- PTFE double diaphragm with integrated diaphragm rupture warning system ensures precise and low-wear operation despite high pressures
- The product chamber is hermetically separated from the hydraulic part
- Integrated hydraulic relief valve and automatic bleed valve for the hydraulic chamber
- Wear-free, valveless enforced anti-cavitation of the hydraulic leakage guarantees optimum dosing precision
- Cone valves for use as suction and/or discharge valves with minimal wear, good self-cleaning and low pressure loss (NPSHR)

Excellent flexibility:

- The modular construction allows a wide range of uses. In multiple pump systems it is possible to combine up to 6 metering units, even with different pump capacities. In single pumps the drive arrangement may be either vertical or horizontal.
- 10 different gear ratios are available
- Temperature range -40 to +150 °C
- Customised designs are available on request

Technical Details

- MfS 18 (MF1a) – Stroke length: 0-15 mm, Rod force: 1,750 N
- MfS 35 (MF2a) – Stroke length: 0-20 mm, Rod force: 3,500 N
- MfS 80 (MF3a) – Stroke length: 0-20 mm, Rod force: 14,000 N
- MfS 180 (MF4a) – Stroke length: 0-40 mm, Rod force: 18,000 N
- MfS 600 (MF5a) – Stroke length: 0-40 mm, Rod force: 40,000 N
- MfS 1400 (MF6a) – Stroke length: 0-60 mm, Rod force: 60,000 N
- Stroke length adjustment range: 0 – 100% in operation and idle
- Stroke length adjustment: manually by means of a manual adjustment wheel and scaled display (optionally with electric actuator or control drive)
- Metering reproducibility is better than ± 0.5 % within the 10 – 100% stroke length range under defined conditions and with correct installation
- PTFE multi-layer diaphragm with electrical diaphragm rupture warning system via a contact
- Integrated hydraulic relief and bleed valve
- Wetted materials: Stainless steel, special designs are available on request
- A wide range of power end versions is available: Three-phase standard motors, motors for use in Exe and Exde areas and different flange designs for use in customer-specific motors
- Degree of protection: IP 55
- Temperature range - 40 °C to + 150 °C
- Suction lift up to 8 m
- Design in compliance with API 675 among others

Field of application

- Oil/ gas production (onshore/offshore)
- Refineries
- Chemical/Petrochemical industry
- Pharmaceuticals & cosmetics
- Food production
- Packaging industry (bottling pumps)

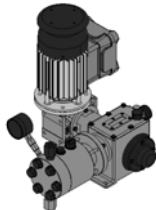

P_ORL_050_SW1
Orlita® MFS 18/12

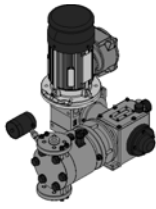

P_ORL_051_SW1
Orlita® MFS 35/30

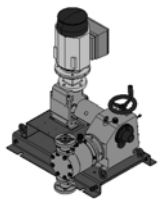

P_ORL_052_SW1
Orlita® MFS 80/40



P_ORL_053_SW1
Orlita® MFS 180/60

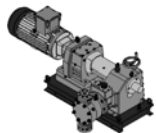

P_ORL_054_SW1
Orlita® MFS 600b/81

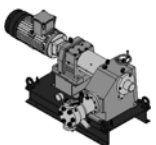

P_ORL_055_SW1
Orlita® MFS 1400/46



2.12 Hydraulic Diaphragm Metering Pumps Orlita® MF

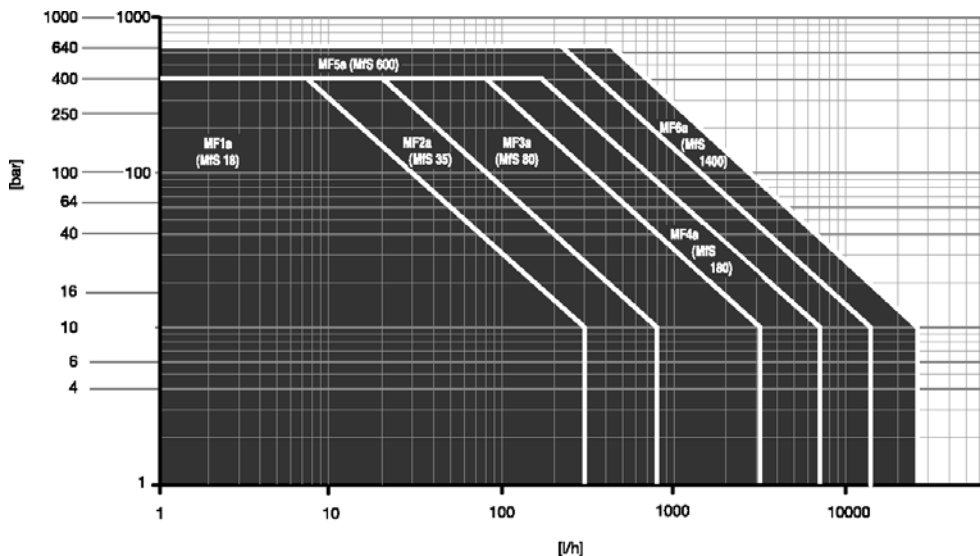

Pressure [bar] depending on the metering volume [l/h] at 50 Hz

Triplex Metering Pumps

With triplex metering pumps, the pressure stroke of each liquid end occurs through 120° of crank travel. This results in a metering flow free of pulsation without the use of elaborate pulsation dampers. This design of process diaphragm pump is preferred in the chemical and petrochemical industries.

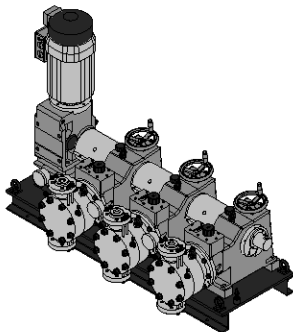

P_ORL_056_SW1
Orlita® MF3S 180/90-90-90 triplex pump

Multiplexed Metering Pumps

The Orlita® MF range's modular construction permits a variable combination of drives, motors and liquid ends e.g. quadruple MF metering pumps with central drive.

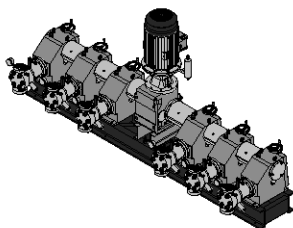

P_ORL_057_SW1
Orlita® MF3S 1400/50 multiple pump

2.12 Hydraulic Diaphragm Metering Pumps Orlita® MF

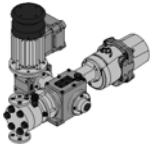

P_ORL_058_SW1
Orlita® MFS 18 with 1-phase control drive
115/230 V

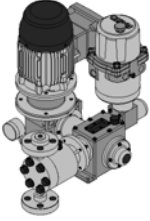

P_ORL_059_SW1
Orlita® MFS 35 with 1-phase control drive
115/230 V vertical

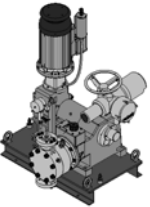

P_ORL_060_SW1
Orlita® MFS 180 with 3-phase control drive



P_ORL_061_SW1
Orlita® MFS 35/12-12 with control drives

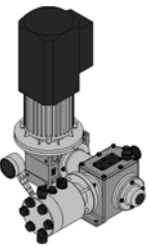

P_ORL_062_SW1
Orlita® MFS 18/7 with Varicon

Actuation of ORLITA® MF, MH, PS, DR

Control drive consisting of an actuator with servo motor and integral servo controller for stroke length adjustment via a standard signal. Standard signal current input 0/4 – 20 mA, corresponds to stroke length 0 – 100%, switch for manual/automatic operation; key switch for stroke adjustment in manual mode, mechanical status display of actual stroke length value output 0/4 – 20 mA for remote display. Control drives can also be designed with bus systems, like HART, PROFIBUS, Fieldbus Foundation ...

Variable speed motors with integrated frequency converter (identity code specification V)

Power supply 1 ph 230 V, 50/60 Hz (up to 3 kW). Externally controllable with 0/4 - 20 mA.

The following functions are integrated in the terminal box cover:

- Start/stop switch
- Switch for manual/external operation
- Potentiometer for speed control in manual mode

Speed controllers with frequency converter (identity code specification Z)

The frequency converter is accommodated in an IP 55 rated protective housing with integral control unit and main switch, suitable for max. 0.37/0.75 kW motor capacity.

Externally controllable with 0/4 - 20 mA or 0 - 10 V corresponding to 0 - 50 (60) Hz output frequency.

Integrated control unit with versatile functions, such as switching between external/internal control; frequency input using arrow keys with internal control, multilingual fault message display etc. and motor temperature monitoring (thermistor protection).

The speed controller assembly consists of a frequency converter and a variable speed motor.

2



2.12 Hydraulic Diaphragm Metering Pumps Orlita® MF

Type of drive

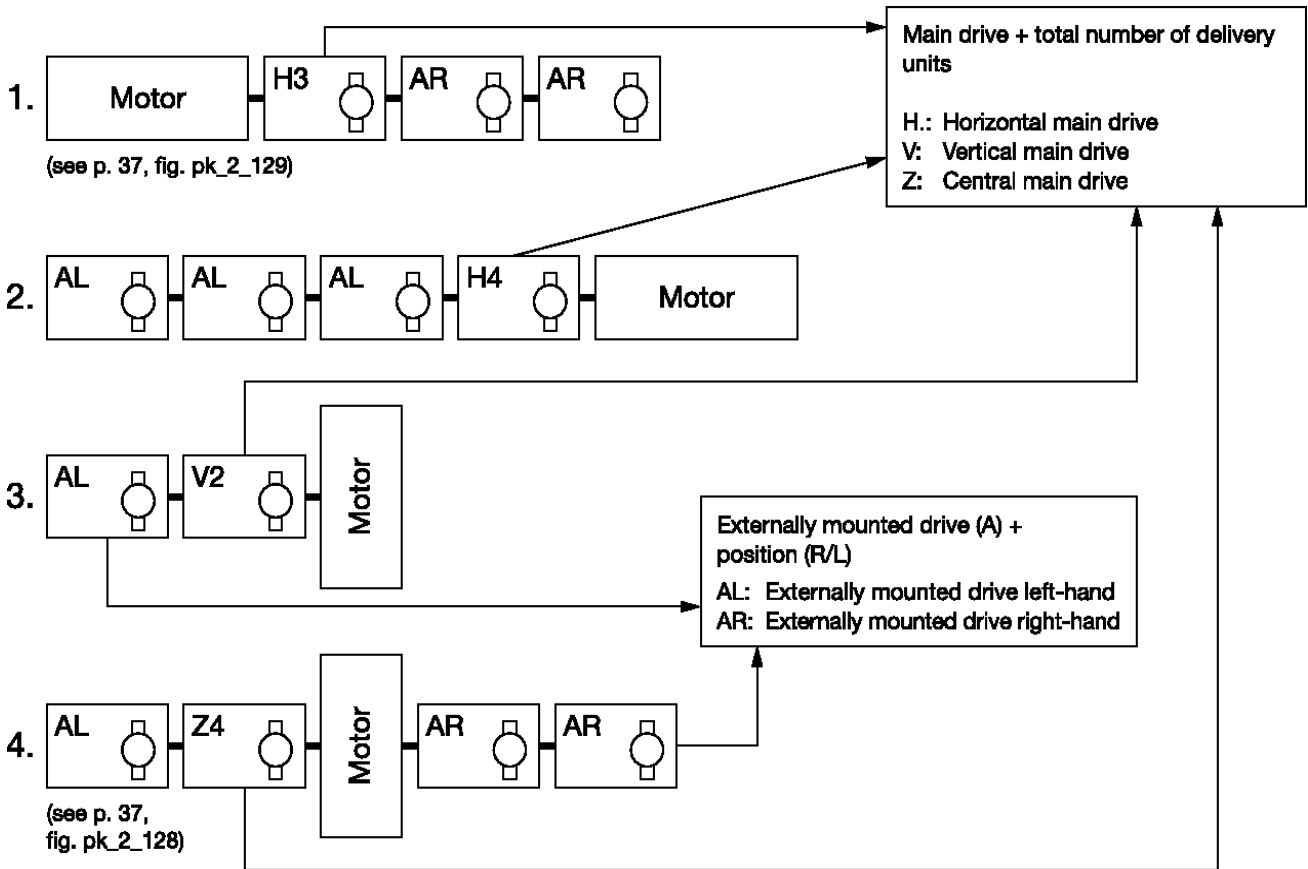

When ordering a multiplexed pump, the main and/or all externally mounted pumps require a separate Identity code.

For example a triplex pompe (1.) :
 MF_aH3.....
 MF_aAR.....
 MF_aAR.....

Materials in Contact With the Medium

	Liquid end	Suction/discharge valve housing	Valve seals	Valve	Valve seat	Range
S1 (DIN)	1.4404	None	1.4571	Ceramic	1.4404	DN 3
S1 (ANSI)	A 316 L	N/A	A 316 Ti	Ceramic	A 316 L	
S1 (DIN)	1.4404	1.4404	1.4571	1.4462	1.4462	≥ DN6
S1 (ANSI)	A 316 L	A 316 L	A 316 Ti	Duplex SS	Duplex SS	
S2 (DIN)	1.4462	1.4462	1.4571	1.4462	1.4462	≥ DN6
S2 (ANSI)	Duplex SS	Duplex SS	A 316 Ti	Duplex SS	Duplex SS	
S3 (DIN)	1.4539	1.4539	2.4610	1.4539	1.4539	≥ DN6
S3 (ANSI)	A904L	A904L	Hastelloy C-4	A904L	A904L	

Motor Data

A	50 Hz	3 ph. 230/400 V	3 ph. 500 V	3 ph. 380/660 V
		3 ph. 400/690 V	3 ph. 415 V	
B (adjustable 1:5)	50 Hz	3 ph. 230/400 V	3 ph. 500 V	3 ph. 380/660 V
		3 ph. 400/690 V	3 ph. 415 V	
H	60 Hz	3 ph. 220/380 V	3 ph. 400 V	
K (adjustable 1:5)	60 Hz	3 ph. 220/380 V	3 ph. 400 V	



2.12 Hydraulic Diaphragm Metering Pumps Orlita® MF

2.12.2 Orlita® MFS 18 (MF1a) Hydraulic Diaphragm Metering Pumps

Technical Data MfS 18 Single Pump 50 Hz

Plunger Ø mm	Stroke volume ml/ stroke	Pump capacity Q _{th} in l/h per pump head at H/min [Identity code characteristic 3 to 9]:							Max. pressure bar	Efficiency at 100% pressure	Efficiency at 50% pressure	Standard type of valve
		45 [3] l/h	58 [4] l/h	73 [5] l/h	91 [6] l/h	112 [7] l/h	145 [8] l/h	207 [9] l/h				
7	0.58	1.5	2.0	2.5	3.1	3.8	5.0	7.1	400	0.50	0.70	DK DN 3
8	0.75	2.0	2.6	3.2	4.1	5.0	6.5	9.3	348	0.55	0.72	DK DN 3
10	1.18	3.2	4.1	5.1	6.4	7.8	10.2	14.6	222	0.67	0.79	Ke DN 6
11	1.43	3.8	4.9	6.2	7.7	9.5	12.4	17.7	184	0.67	0.79	Ke DN 6
12	1.70	4.6	5.9	7.3	9.2	11.3	14.7	21.0	154	0.84	0.88	Ke DN 6
14	2.31	6.2	8.0	10.0	12.5	15.4	20.0	28.7	113	0.85	0.88	Ke DN 6
16	3.02	8.2	10.5	13.1	16.4	20.1	26.2	37.4	87	0.86	0.88	Ke DN 6
18	3.82	10.3	13.2	16.6	20.7	25.5	33.2	47.4	68	0.87	0.88	Ke DN 6
20	4.71	12.8	16.4	20.5	25.6	31.5	41.0	58.5	55	0.88	0.89	Ke DN 6
22	5.70	15.5	19.8	24.8	31.0	38.1	49.6	70.8	46	0.88	0.89	Ke DN 10/6
25	7.36	20.0	25.6	32.0	40.0	49.2	64.0	91.5	35	0.89	0.89	Ke DN 10
27	8.59	23.3	29.8	37.3	46.7	57.4	74.7	106.7	30	0.89	0.89	Ke DN 10
29	9.91	26.9	34.4	43.1	53.8	66.3	86.2	123.1	26	0.89	0.89	Ke DN 10
30	10.60	28.8	36.9	46.1	57.6	70.9	92.2	131.7	24	0.89	0.89	Ke DN 10
36	15.27	41.5	53.1	66.4	83.0	102.1	132.8	189.7	17	0.89	0.89	Ke DN 16
40	18.85	51.2	65.6	82.0	102.4	126.1	163.9	234.2	13	0.89	0.89	Ke DN 16
44	22.81	62.0	79.3	99.2	124.0	152.6	198.4	283.4	11	0.89	0.90	Ke DN 16
50	29.45	80.0	102.4	128.1	160.1	197.1	256.2	366.0	8	0.89	0.90	Ke DN 16

Technical Data MfS 18 Single Pump 60 Hz

Plunger Ø mm	Stroke volume ml/ stroke	Pump capacity Q _{th} in l/h per pump head at H/min [Identity code characteristic 2 to 8]:							Max. pressure bar	Efficiency at 100% pressure	Efficiency at 50% pressure	Standard type of valve
		44 [2] l/h	55 [3] l/h	70 [4] l/h	88 [5] l/h	110 [6] l/h	135 [7] l/h	176 [8] l/h				
7	0.58	1.5	1.9	2.4	3.0	3.8	4.6	6.1	400	0.50	0.70	DK DN 3
8	0.75	1.9	2.4	3.1	3.9	4.9	6.1	7.9	348	0.55	0.72	DK DN 3
10	1.18	3.1	3.8	4.9	6.2	7.7	9.5	12.4	222	0.67	0.79	Ke DN 6
11	1.43	3.7	4.7	6.0	7.5	9.4	11.5	15.0	184	0.67	0.79	Ke DN 6
12	1.70	4.4	5.6	7.1	8.9	11.2	13.7	17.9	154	0.84	0.88	Ke DN 6
14	2.31	6.1	7.6	9.7	12.1	15.2	18.7	24.3	113	0.85	0.88	Ke DN 6
16	3.02	7.9	9.9	12.7	15.9	19.9	24.5	31.8	87	0.86	0.88	Ke DN 6
18	3.82	10.0	12.6	16.1	20.1	25.1	31.0	40.3	68	0.87	0.88	Ke DN 6
20	4.71	12.4	15.5	19.9	24.8	31.1	38.2	49.7	55	0.88	0.89	Ke DN 6
22	5.70	15.0	18.8	24.0	30.1	37.6	46.3	60.2	46	0.88	0.89	Ke DN 10/6
25	7.36	19.4	24.3	31.1	38.8	48.6	59.8	77.7	35	0.89	0.89	Ke DN 10
27	8.59	22.6	28.3	36.2	45.3	56.6	69.7	90.6	30	0.89	0.89	Ke DN 10
29	9.91	26.1	32.7	41.8	52.3	65.3	80.4	104.6	26	0.89	0.89	Ke DN 10
30	10.60	27.9	34.9	44.7	55.9	69.9	86.1	111.9	24	0.89	0.89	Ke DN 10
36	15.27	40.3	50.3	64.4	80.6	100.7	124.0	161.2	17	0.89	0.89	Ke DN 16
40	18.85	49.7	62.2	79.6	99.5	124.4	153.1	199.0	13	0.89	0.89	Ke DN 16
44	22.81	60.2	75.2	96.3	120.1	150.5	185.2	240.8	11	0.89	0.90	Ke DN 16
50	29.45	77.7	97.1	124.4	155.5	194.3	239.2	311.0	8	0.89	0.90	Ke DN 16

DK Double ball valve, Ke Conical valve

- Important note:**
- Abridged presentation of our complete product range. Other types on request
 - Allow for a minimum 10% power reserve when designing in accordance with API
 - All hydraulic performance data is based on water at 20 °C





2.12 Hydraulic Diaphragm Metering Pumps Orlita® MF

Identity Code Ordering System

Orlita® MFS18 (MF1a) hydraulic diaphragm metering pump

MF1a		Drive type									
V1	Main drive vertical*									AR	Drive module right-hand
Z1	Main drive central*									M	Modified **
AL	Drive module left-hand										
Plunger diameter											
007	7 mm	011	11 mm	016	16 mm	022	22 mm	029	29 mm	040	40 mm
008	8 mm	012	12 mm	018	18 mm	025	25 mm	030	30 mm	044	44 mm
010	10 mm	014	14 mm	020	20 mm	027	27 mm	036	36 mm	050	50 mm
Stroke rate 50 (60) Hz											
2	-/44 strokes/min	4	58 (70) Strokes/min	6	91 (110) Strokes/min	8	145 (176) Strokes/min				
3	45 (55) strokes/min	5	73 (88) Strokes/min	7	112 (135) Strokes/min	9	207 (-) Strokes/min				
Liquid end material (including valve materials)											
S1	Stainless steel (see table, sheet 2)										
Temperature of pumped medium											
0	-10 °C to 80 °C			3	10 °C to 115 °C						
1	-25 °C to 60 °C			4	10 °C to 150 °C						
2	-40 °C to 60 °C										
Displacer format											
0	PTFE multi-layer diaphragm										
1	PTFE multi-layer diaphragm with pressure gauge										
Liquid end version											
0	Standard					2	Standard double valve				
1	Standard with spring					3	Standard double valve with spring				
Hydraulic connection suction side											
G	Thread DIN/ISO				A	Flange ANSI					
N	Thread NPT/ANSI				D	Flange DIN/ISO					
Hydraulic connection discharge side											
G	Thread DIN/ISO				A	Flange ANSI					
N	Thread NPT/ANSI				D	Flange DIN/ISO					
Version											
0	no features					2	Liquid end polished				
1	Liquid end heating					3	Special paint finish				
Power connector											
A	Standard voltage 50 Hz										
B	Standard voltage 50 Hz adjustable										
H	Standard voltage 60 Hz										
K	Standard voltage 60 Hz adjustable										
0	Externally mounted pump										
1	without motor with IEC flange										
2	without motor with NEMA flange										
Electrical protection system / explosion protection											
0	IP 55			C	IP 55 EExde						
1	IP 56			D	IP 56 EExn						
A	IP 55 EExn			E	IP 56 EExe						
B	IP 55 EExe			F	IP 56 EExde						
Electrical options											
0	no options										
1	Stroke sensor										
Stroke length adjustment											
0	manual										
1	0/4-20 mA without Ex										
2	0/4-20 mA Ex Zone 2										
3	0/4-20 mA Ex Zone 1										
4	0/4-20 mA without EX offshore										
5	0/4-20 mA Ex Zone 2 offshore										
6	0/4-20 mA Ex Zone 1 offshore										
Environmental conditions											
0	-20 °C to 40 °C										
1	-40 °C to 40 °C										
2	0 °C to 55 °C										
Approvals											
0	CE										
1	API 675										
2	VDMA										
3	ATEX										
4	ATEX / API 675										
5	VDMA / ATEX										

*For other pump configurations see Type of drive page → 2-55

** Modified version (M) is possible for each ID character of the identity code.

2.12 Hydraulic Diaphragm Metering Pumps Orlita® MF

2.12.3 Orlita® MFS 35 (MF2a) Hydraulic Diaphragm Metering Pumps

Technical Data MfS 35 Single Pump 50 Hz

Plunger Ø mm	Stroke volume ml/ stroke	Pump capacity Q _{th} in l/h per pump head at H/min [Identity code characteristic 3 to 9]:							Max. pressure bar	Efficiency at 100% pressure	Efficiency at 50% pressure	Standard type of valve
		45 [3] l/h	58 [4] l/h	73 [5] l/h	91 [6] l/h	112 [7] l/h	145 [8] l/h	207 [9] l/h				
7	0.77	2.0	2.6	3.3	4.1	5.1	6.7	9.5	400	0.50	0.70	DK DN 3
8	1.01	2.7	3.5	4.3	5.4	6.7	8.7	12.4	400	0.50	0.70	DK DN 3
10	1.57	4.2	5.4	6.8	8.5	10.5	13.6	19.5	400	0.50	0.70	Ke DN 6
11	1.90	5.1	6.6	8.2	10.3	12.7	16.5	23.6	368	0.79	0.85	Ke DN 6
12	2.26	6.1	7.8	9.8	12.3	15.1	19.6	28.1	309	0.79	0.85	Ke DN 6
14	3.08	8.3	10.7	13.3	16.7	20.6	26.7	38.2	227	0.81	0.85	Ke DN 6
16	4.02	10.9	13.9	17.4	21.8	26.9	34.9	49.9	174	0.83	0.86	Ke DN 6
18	5.09	13.8	17.7	22.1	27.6	34.0	44.2	63.2	137	0.84	0.87	Ke DN 6
20	6.28	17.0	21.8	27.3	34.1	42.0	54.6	78.0	111	0.86	0.88	Ke DN 6
22	7.60	20.6	26.4	33.0	41.3	50.8	66.1	94.4	92	0.86	0.88	Ke DN 10/6
25	9.82	26.6	34.1	42.7	53.3	65.7	85.4	122.0	71	0.87	0.88	Ke DN 10
27	11.45	31.1	39.8	49.8	62.2	76.6	99.6	142.3	61	0.87	0.88	Ke DN 10
30	14.14	38.4	49.2	61.5	76.8	94.6	122.9	175.7	49	0.88	0.89	Ke DN 10
36	20.36	55.3	70.8	88.5	110.6	136.2	177.1	253.0	34	0.88	0.89	Ke DN 16
40	25.13	68.3	87.4	109.3	136.6	168.2	218.6	312.3	27	0.89	0.89	Ke DN 16
44	30.41	82.6	105.8	132.2	165.3	203.5	264.5	377.9	23	0.89	0.89	Ke DN 16
50	39.27	106.7	136.6	170.8	213.5	262.8	341.6	488.0	17	0.89	0.89	Ke DN 16
60	56.55	153.7	196.7	245.9	307.4	378.4	491.9	702.8	12	0.89	0.90	Ke DN 16/25
65	66.37	180.4	230.9	288.6	360.8	444.1	577.3	824.8	10	0.89	0.90	Ke DN 16/25
80	100.53	273.3	349.8	437.3	546.6	672.7	874.6	1,249.4	6	0.89	0.90	Ke DN 25

Technical Data MfS 35 Single Pump 60 Hz

Plunger Ø mm	Stroke volume ml/ stroke	Pump capacity Q _{th} in l/h per pump head at H/min [Identity code characteristic 2 to 8]:							Max. pressure bar	Efficiency at 100% pressure	Efficiency at 50% pressure	Standard type of valve
		44 [2] l/h	55 [3] l/h	70 [4] l/h	88 [5] l/h	110 [6] l/h	135 [7] l/h	176 [8] l/h				
7	0.77	2.0	2.5	3.2	4.0	5.0	6.2	8.1	400	0.50	0.70	DK DN 3
8	1.01	2.6	3.3	4.2	5.3	6.6	8.1	10.6	400	0.50	0.70	DK DN 3
10	1.57	4.1	5.1	6.6	8.2	10.3	12.7	16.5	400	0.50	0.70	Ke DN 6
11	1.90	5.0	6.2	8.0	10.0	12.5	15.4	20.0	368	0.79	0.85	Ke DN 6
12	2.26	5.9	7.4	9.5	11.9	14.9	18.3	23.8	309	0.79	0.85	Ke DN 6
14	3.08	8.1	10.1	13.0	16.2	20.3	25.0	32.5	227	0.81	0.85	Ke DN 6
16	4.02	10.6	13.2	16.9	21.2	26.5	32.6	42.4	174	0.83	0.86	Ke DN 6
18	5.09	13.4	16.7	21.5	26.8	33.5	41.3	53.7	137	0.84	0.87	Ke DN 6
20	6.28	16.5	20.7	26.5	33.1	41.4	51.0	66.3	111	0.86	0.88	Ke DN 6
22	7.60	20.0	25.0	32.1	40.1	50.1	61.7	80.2	92	0.86	0.88	Ke DN 10/6
25	9.82	25.9	32.4	41.4	51.8	64.8	79.7	103.6	71	0.87	0.88	Ke DN 10
27	11.45	30.2	37.7	48.3	60.4	75.5	93.0	120.9	61	0.87	0.88	Ke DN 10
30	14.14	37.3	46.6	59.7	74.6	93.3	114.8	149.2	49	0.88	0.89	Ke DN 10
36	20.36	53.7	67.1	85.9	107.4	134.3	165.3	214.9	34	0.88	0.89	Ke DN 16
40	25.13	66.3	82.9	106.1	132.7	165.8	204.1	265.4	27	0.89	0.89	Ke DN 16
44	30.41	80.2	100.3	128.4	160.5	200.7	247.0	321.1	23	0.89	0.89	Ke DN 16
50	39.27	103.6	129.5	165.8	207.3	259.1	318.9	414.6	17	0.89	0.89	Ke DN 16
60	56.55	149.2	186.6	238.8	298.5	373.2	459.3	597.1	12	0.89	0.90	Ke DN 16/25
65	66.37	175.2	219.0	280.3	350.4	438.0	539.1	700.8	10	0.89	0.90	Ke DN 16/25
80	100.53	265.4	331.7	424.6	530.8	663.5	816.6	1,061.6	6	0.89	0.90	Ke DN 25

DK Double ball valve, Ke Conical valve

- Important note:**
- Abridged presentation of our complete product range. Other types on request
 - Allow for a minimum 10% power reserve when designing in accordance with API
 - All hydraulic performance data is based on water at 20 °C





2.12 Hydraulic Diaphragm Metering Pumps Orlita® MF

Identity Code Ordering System

Orlita® MFS35 (MF2a) hydraulic diaphragm metering pump

MF2a	Drive type											
	V1	Main drive vertical *				AR	Drive module right-hand					
	Z1	Main drive central *				M	Modified **					
	AL	Drive module left-hand										
	Plunger diameter											
	007	7 mm	012	12 mm	020	20 mm	030	30 mm	050	50 mm		
	008	8 mm	014	14 mm	022	22 mm	036	36 mm	060	60 mm		
	010	10 mm	016	16 mm	025	25 mm	040	40 mm	065	65 mm		
	011	11 mm	018	18 mm	027	27 mm	044	44 mm	080	80 mm		
	Stroke rate 50 (60) Hz											
	2	-/44 strokes/min		4	58 (70) Strokes/min		6	91 (110) Strokes/min		8	145 (176) Strokes/min	
	3	45 (55) strokes/min		5	73 (88) Strokes/min		7	112 (135) Strokes/min		9	207 (-) Strokes/min	
	Liquid end material (including valve materials)											
	S1	Stainless steel (see table, sheet 2)										
	Temperature of pumped medium											
	0	-10 °C to 80 °C			2	-40 °C to 60 °C			4	10 °C to 150 °C		
	1	-25 °C to 60 °C			3	10 °C to 115 °C						
	Displacer format											
	0	PTFE multi-layer diaphragm										
	1	PTFE multi-layer diaphragm with pressure gauge										
	Liquid end version											
	0	Standard				2	Standard + double valve					
	1	Standard with spring				3	Standard + double valve with spring					
	Hydraulic connection suction side											
	G	Thread DIN/ISO				A	Flange ANSI					
N	Thread NPT/ANSI				D	Flange DIN/ISO						
Hydraulic connection discharge side												
G	Thread DIN/ISO				A	Flange ANSI						
N	Thread NPT/ANSI				D	Flange DIN/ISO						
Version												
0	no features											
1	Liquid end heating											
2	Liquid end polished											
3	Special paint finish											
Power connector												
A	Standard voltage 50 Hz											
B	Standard voltage 50 Hz adjustable											
H	Standard voltage 60 Hz											
K	Standard voltage 60 Hz adjustable											
0	Externally mounted pump											
1	without motor with IEC flange											
2	without motor with NEMA flange											
Electrical protection system / explosion protection												
0	IP 55		D	IP 56 EExn								
1	IP 56		E	IP 56 EExe								
A	IP 55 EExn		F	IP 56 EExde								
B	IP 55 EExe		K	IP 65 EExde								
C	IP 55 EExde											
Electrical options												
0	no options											
1	Stroke sensor											
Stroke length adjustment												
0	manual											
1	0/4-20 mA without Ex											
2	0/4-20 mA Ex Zone 2											
3	0/4-20 mA Ex Zone 1											
4	0/4-20 mA without EX offshore											
5	0/4-20 mA Ex Zone 2 offshore											
6	0/4-20 mA Ex Zone 1 offshore											
Environmental conditions												
0	-20 °C to 40 °C											
1	-40 °C to 40 °C											
2	0 °C to 55 °C											
Approvals												
0	CE											
1	API 675											
2	VDMA											
3	ATEX											
4	ATEX / API 675											
5	VDMA / ATEX											

*For further pump configurations see Type of drive page → 2-55

** Modified design (M) is available with every identity code feature

2.12 Hydraulic Diaphragm Metering Pumps Orlita® MF

2.12.4 Orlita® MFS 80 (MF3a) Hydraulic Diaphragm Metering Pumps

Technical Data MfS 80 Single Pump 50 Hz

Plunger Ø	Stroke volume	Pump capacity Q_{th} in l/h per pump head at H/min [Identity code characteristic 4 to 9; F]:							Max. pressure	Efficiency at 100% pressure	Efficiency at 50% pressure	Standard type of valve
		104 [4]	122 [5]	134 [6]	155 [7]	160 [8]	182 [9]	193 [F]				
mm	ml/stroke	l/h	l/h	l/h	l/h	l/h	l/h	l/h	bar			
16	4.02	25	29	32	37	38	43	46	400	0.75	0.83	Ke DN 6
20	6.28	39	46	50	58	60	68	72	400	0.75	0.83	Ke DN 6
22	7.60	47	55	61	70	73	82	87	360	0.79	0.80	Ke DN 10/6
25	9.82	61	71	79	91	94	107	113	285	0.79	0.85	Ke DN 10
27	11.45	71	83	92	106	109	125	132	244	0.81	0.85	Ke DN 10
29	13.21	82	96	106	122	126	144	152	211	0.82	0.85	Ke DN 10
30	14.14	88	103	113	131	135	154	163	198	0.83	0.86	Ke DN 10
36	20.36	126	149	164	189	195	222	235	137	0.85	0.87	Ke DN 16
40	25.13	156	184	202	233	241	274	290	111	0.86	0.88	Ke DN 16
44	30.41	189	222	245	282	292	331	351	98	0.86	0.88	Ke DN 16
46	33.24	207	243	268	309	319	362	384	84	0.86	0.88	Ke DN 16
50	39.27	244	287	316	365	377	428	453	71	0.87	0.88	Ke DN 16
60	56.55	352	414	455	526	543	617	653	50	0.88	0.89	Ke DN 16/25
65	66.37	413	486	535	617	637	724	766	40	0.88	0.89	Ke DN 16/25
80	100.53	626	736	810	935	965	1,097	1,161	25	0.89	0.89	Ke DN 25
100	157.08	979	1,150	1,266	1,461	1,508	1,714	1,814	17	0.89	0.89	Ke DN 32

Technical Data MfS 80 Single Pump 60 Hz

Plunger Ø	Stroke volume	Pump capacity Q_{th} in l/h per pump head at H/min [Identity code characteristic 3 to 9]:							Max. pressure	Efficiency at 100% pressure	Efficiency at 50% pressure	Standard type of valve
		119 [3]	126 [4]	148 [5]	163 [6]	188 [7]	194 [8]	221 [9]				
mm	ml/stroke	l/h	l/h	l/h	l/h	l/h	l/h	l/h	bar			
16	4.02	28	30	35	39	45	46	53	400	0.75	0.83	Ke DN 6
20	6.28	44	47	55	61	70	73	83	400	0.75	0.83	Ke DN 6
22	7.60	54	57	67	74	85	88	100	360	0.79	0.80	Ke DN 10/6
25	9.82	70	74	87	96	110	114	130	285	0.79	0.85	Ke DN 10
27	11.45	81	86	101	112	129	133	151	244	0.81	0.85	Ke DN 10
29	13.21	94	100	117	129	149	153	175	211	0.82	0.85	Ke DN 10
30	14.14	101	107	125	138	159	164	187	198	0.83	0.86	Ke DN 10
36	20.36	145	154	180	199	229	237	269	137	0.85	0.87	Ke DN 16
40	25.13	179	190	223	245	283	292	333	111	0.86	0.88	Ke DN 16
44	30.41	217	230	270	297	343	354	402	98	0.86	0.88	Ke DN 16
46	33.24	237	251	295	325	375	387	440	84	0.86	0.88	Ke DN 16
50	39.27	280	297	349	384	443	457	520	71	0.87	0.88	Ke DN 16
60	56.55	404	428	502	553	638	659	749	50	0.88	0.89	Ke DN 16/25
65	66.37	474	502	589	649	749	773	879	40	0.88	0.89	Ke DN 16/25
80	100.53	718	761	893	983	1,134	1,171	1,332	25	0.89	0.89	Ke DN 25
100	157.08	1,123	1,189	1,396	1,537	1,774	1,830	2,081	17	0.89	0.89	Ke DN 32

Ke Conical valve

Important note:

- Abridged presentation of our complete product range. Other types on request
- Allow for a minimum 10% power reserve when designing in accordance with API
- All hydraulic performance data is based on water at 20 °C





2.12 Hydraulic Diaphragm Metering Pumps Orlita® MF

Identity Code Ordering System

Orlita® MFS 80 (MF3a) hydraulic diaphragm metering pump

MF3a	Drive type															
	H1	Main drive horizontal*						AL	Drive module left-hand							
	V1	Main drive vertical*						AR	Drive module right-hand							
	Z1	Main drive central*						M	Modified **							
	Plunger diameter															
	016	16 mm	025	25 mm	030	30 mm	044	44 mm	060	60 mm	100	100 mm				
	020	20 mm	027	27 mm	036	36 mm	046	46 mm	065	65 mm						
	022	22 mm	029	29 mm	040	40 mm	050	50 mm	080	80 mm						
	Stroke rate 50 (60) Hz															
	3	- (119) Strokes/min			5	122 (148) Strokes/min			7	155 (188) Strokes/min			9	182 (221) strokes/min		
	4	104 (126) strokes/min			6	134 (163) Strokes/min			8	160 (194) Strokes/min			F	193 (-) Strokes/min		
	Liquid end material (including valve materials)															
	S1	Stainless steel (see table, sheet 2)														
	Temperature of pumped medium															
	0	-10 °C to 80 °C			2	-40 °C to 60 °C			4	10 °C to 150 °C						
	1	-25 °C to 60 °C			3	10 °C to 115 °C			4	10 °C to 150 °C						
	Displacer format															
	0	PTFE multi-layer diaphragm														
	1	PTFE multi-layer diaphragm with pressure gauge														
	Liquid end version															
	0	Standard			2	Standard + double valve										
	1	Standard with spring			3	Standard + double valve with spring										
	Hydraulic connection suction side															
	G	Thread DIN/ISO						A	Flange ANSI							
	N	Thread NPT/ANSI						D	Flange DIN/ISO							
	Hydraulic connection discharge side															
	G	Thread DIN/ISO						A	Flange ANSI							
	N	Thread NPT/ANSI						D	Flange DIN/ISO							
Version																
0	no features															
1	Liquid end heating															
2	Liquid end polished															
3	Special paint finish															
Power connector																
A	Standard voltage 50 Hz															
B	Standard voltage 50 Hz adjustable															
H	Standard voltage 60 Hz															
K	Standard voltage 60 Hz adjustable															
0	Externally mounted pump															
1	without motor with IEC flange															
2	without motor with NEMA flange															
Electrical protection system / explosion protection																
0	IP 55			D	IP 56 EExn											
1	IP 56			E	IP 56 EExe											
A	IP 55 EExn			F	IP 56 EExde											
B	IP 55 EExe			K	IP 65 EExde											
C	IP 55 EExde															
Electrical options																
0	no options															
1	Stroke sensor															
Stroke length adjustment																
0	manual															
1	0/4-20 mA without Ex															
2	0/4-20 mA Ex Zone 2															
3	0/4-20 mA Ex Zone 1															
4	0/4-20 mA Ex without EX offshore															
5	0/4-20 mA Ex Zone 2 offshore															
6	0/4-20 mA Ex Zone 1 offshore															
Environmental conditions																
0	-20 °C to 40 °C															
1	-40 °C to 40 °C															
2	0 °C to 55 °C															
Approvals																
0	CE															
1	API 675															
2	VDMA															
3	ATEX															
4	ATEX / API 675															
5	VDMA / ATEX															

*For further pump configurations see Type of drive page → 2-55

** Modified design (M) is available with every identity code feature

2.12 Hydraulic Diaphragm Metering Pumps Orlita® MF

2.12.5 Orlita® MFS 180 (MF4a) Hydraulic Diaphragm Metering Pumps

Technical Data MfS 180 Single Pump 50 Hz

Plunger Ø	Stroke volume	Pump capacity Q _{th} in l/h per pump head at H/min [Identity code characteristic 4 to 9; F]:							Max. pressure	Efficiency at 100% pressure	Efficiency at 50% pressure	Standard type of valve
		92 [4]	107 [5]	117 [6]	134 [7]	152 [8]	171 [9]	200 [F]				
mm	ml/stroke	l/h	l/h	l/h	l/h	l/h	l/h	l/h	bar			
25	19.63	107	126	138	157	178	201	235	366	0.77	0.83	Ke DN 16
30	28.27	155	181	199	226	257	290	339	254	0.81	0.85	Ke DN 16
36	40.72	223	262	286	326	370	417	489	176	0.83	0.86	Ke DN 16
40	50.27	276	323	353	403	457	515	604	143	0.85	0.87	Ke DN 25
44	60.82	334	391	428	488	553	623	730	118	0.85	0.87	Ke DN 25
50	78.54	431	505	552	630	714	805	943	91	0.86	0.88	Ke DN 25
55	95.03	521	611	668	762	864	974	1,141	75	0.87	0.88	Ke DN 32
60	113.10	621	727	796	907	1,029	1,160	1,359	63	0.87	0.89	Ke DN 32
65	132.73	729	854	934	1,065	1,207	1,361	1,594	54	0.88	0.89	Ke DN 32
70	153.94	845	990	1,083	1,235	1,400	1,579	1,849	46	0.88	0.89	Ke DN 40
75	176.71	970	1,137	1,243	1,418	1,608	1,812	2,123	40	0.88	0.89	Ke DN 40
80	201.06	1,104	1,293	1,415	1,613	1,829	2,062	2,416	35	0.88	0.89	Ke DN 40
85	226.98	1,246	1,460	1,597	1,821	2,065	2,328	2,727	31	0.88	0.89	Ke DN 40
90	254.47	1,397	1,637	1,791	2,042	2,315	2,610	3,057	28	0.89	0.89	Ke DN 40
95	283.53	1,557	1,824	1,995	2,275	2,590	2,908	3,407	25	0.89	0.89	Pt DN 50
100	314.16	1,725	2,021	2,211	2,521	2,858	3,223	3,775	22	0.89	0.89	Pt DN 50
115	415.48	2,281	2,673	2,924	3,334	3,781	4,262	4,992	17	0.89	0.89	Pt DN 65
125	490.87	2,696	3,158	3,455	3,939	4,467	5,036	–	14	0.89	0.90	Pt DN 65
135	572.56	3,144	3,684	4,030	4,595	5,210	5,874	6,880	12	0.89	0.90	Pt DN 65
142	633.47	3,479	4,076	4,458	5,084	5,764	6,499	7,612	11	0.89	0.90	Pt DN 65

Technical Data MfS 180 Single Pump 60 Hz

Plunger Ø	Stroke volume	Pump capacity Q _{th} in l/h per pump head at H/min [Identity code characteristic 3 to 9]:							Max. pressure	Efficiency at 100% pressure	Efficiency at 50% pressure	Standard type of valve
		98 [3]	111 [4]	130 [5]	142 [6]	162 [7]	184 [8]	208 [9]				
mm	ml/stroke	l/h	l/h	l/h	l/h	l/h	l/h	l/h	bar			
25	19.63	116	130	153	167	216	244	244	352	0.77	0.83	Ke DN 16
30	28.27	167	188	220	241	275	312	352	254	0.81	0.85	Ke DN 16
36	40.72	240	271	318	347	396	449	507	176	0.83	0.86	Ke DN 16
40	50.27	297	335	392	429	489	555	625	143	0.85	0.87	Ke DN 25
44	60.82	359	405	475	519	592	671	757	118	0.85	0.87	Ke DN 25
50	78.54	464	523	613	671	765	867	978	91	0.86	0.88	Ke DN 25
55	95.03	561	633	742	811	925	1,049	1,183	75	0.87	0.88	Ke DN 32
60	113.10	668	753	883	966	1,101	1,249	1,408	63	0.87	0.89	Ke DN 32
65	132.73	784	884	1,036	1,134	1,293	1,466	1,652	54	0.88	0.89	Ke DN 32
70	153.94	909	1,026	1,202	1,315	1,499	1,700	1,916	46	0.88	0.89	Ke DN 40
75	176.71	1,044	1,178	1,380	1,509	1,721	1,951	2,200	40	0.88	0.89	Ke DN 40
80	201.06	1,188	1,340	1,570	1,717	1,958	2,220	2,503	35	0.88	0.89	Ke DN 40
85	226.98	1,341	1,513	1,772	1,939	2,211	2,507	2,826	31	0.88	0.89	Ke DN 40
90	254.47	1,503	1,696	1,987	2,174	2,478	2,810	3,168	28	0.89	0.89	Ke DN 40
95	283.53	1,675	1,890	2,214	2,422	2,762	3,131	3,530	25	0.89	0.89	Pt DN 50
100	314.16	1,856	2,094	2,453	2,684	3,060	3,470	3,912	22	0.89	0.89	Pt DN 50
115	415.48	2,455	2,769	3,245	3,549	4,047	4,589	5,173	17	0.89	0.89	Pt DN 65
125	490.87	2,900	3,272	3,834	4,193	4,781	5,422	–	14	0.89	0.90	Pt DN 65
135	572.56	3,383	3,817	4,472	4,891	5,577	6,324	–	11	0.89	0.90	Pt DN 65
142	633.47	3,743	4,223	4,947	5,412	6,171	6,997	–	11	0.89	0.90	Pt DN 65

DK Double ball valve, Pt Plate valve

Important note:

- Abridged presentation of our complete product range. Other types on request
- Allow for a minimum 10% power reserve when designing in accordance with API
- All hydraulic performance data is based on water at 20 °C





2.12 Hydraulic Diaphragm Metering Pumps Orlita® MF

Identity Code Ordering System

Orlita® MFS 180 (MF4a) hydraulic diaphragm metering pump

MF4a	Drive type	
H1	Main drive horizontal*	Z1 Main drive central * AR Drive module right-hand Modified **
V1	Main drive vertical*	AL Drive module left-hand M Modified **
Plunger diameter		
025	25 mm	044 44 mm 065 65 mm 085 85 mm 115 115 mm
030	30 mm	050 50 mm 070 70 mm 090 90 mm 125 125 mm
036	36 mm	055 55 mm 075 75 mm 095 95 mm 135 135 mm
040	40 mm	060 60 mm 080 80 mm 100 100 mm 142 142 mm
Stroke rate 50 (60) Hz		
3	- (98) Strokes/min 7 134 (162) Strokes/min	
4	92 (111) strokes/min 8 152 (184) Strokes/min	
5	107 (130) Strokes/min 9 171 (208) strokes/min	
6	117 (142) Strokes/min F 200 (-) Strokes/min	
Liquid end material (including valve materials)		
S1	Stainless steel (see table, sheet 2)	
Temperature of pumped medium		
0	-10 °C to 80 °C	2 -40 °C to 60 °C 4 10 °C to 150 °C
1	-25 °C to 60 °C	3 10 °C to 115 °C
Displacer format		
0	PTFE multi-layer diaphragm	
1	PTFE multi-layer diaphragm with pressure gauge	
Liquid end version		
0	Standard 2 Standard + double valve	
1	Standard with spring 3 Standard + double valve with spring	
Hydraulic connection suction side		
G	Thread DIN/ISO A Flange ANSI	
N	Thread NPT/ANSI D Flange DIN/ISO	
Hydraulic connection discharge side		
G	Thread DIN/ISO A Flange ANSI	
N	Thread NPT/ANSI D Flange DIN/ISO	
Version		
0	No features 2 Liquid end polished	
1	Liquid end heating 3 Special paint finish	
Power connector		
A	Standard voltage 50Hz	
B	Standard voltage 50Hz adjustable	
H	Standard voltage 60Hz	
K	Standard voltage 60Hz adjustable	
0	Externally mounted pump	
1	without motor with IEC flange	
2	without motor with NEMA flange	
Electrical protection system / explosion protection		
0	IP 55	D IP 56 EExn
1	IP 56	E IP 56 EExe
A	IP 55 EExn	F IP 56 EExde
B	IP 55 EExe	K IP 65 EExde
C	IP 55 EExde	
Electrical options		
0	No options	
1	Stroke sensor	
Stroke length adjustment		
0	Manual	
1	0/4-20 mA without Ex	
2	0/4-20 mA Ex Zone 2	
3	0/4-20 mA Ex Zone 1	
4	0/4-20 mA Ex without EX offshore	
5	0/4-20 mA Ex Zone 2 offshore	
6	0/4-20 mA Ex Zone 1 offshore	
Environmental conditions		
0	-20 °C to 40 °C	
1	-40 °C to 40 °C	
2	0 °C to 55 °C	
Approvals		
0	CE	
1	API 675	
2	VDMA	
3	ATEX	
4	ATEX / API 675	
5	VDMA / ATEX	

*For further pump configurations see Type of drive page → 2-55

** Modified design (M) is available with every identity code feature

2.12 Hydraulic Diaphragm Metering Pumps Orlita® MF

2.12.6 Orlita® MFS 600 (MF5b) Hydraulic Diaphragm Metering Pumps

Technical Data MfS 600 Single Pump 50 Hz

Plunger Ø	Stroke volume	Pump capacity Q _{th} in l/h per pump head at H/min [Identity code characteristic 4 to 9; F]:							Max. pressure	Efficiency at 100% pressure	Efficiency at 50% pressure	Standard type of valve
		90 [4]	99 [5]	117 [6]	134 [7]	156 [8]	173 [9]	204 [F]				
mm	ml/stroke	l/h	l/h	l/h	l/h	l/h	l/h	l/h	bar			
36	40.72	219	242	285	327	381	422	497	392	0.76	0.83	Ke DN 16
38	45.36	244	269	318	364	424	470	554	352	0.77	0.83	Ke DN 16
40	50.27	270	299	352	404	470	521	614	318	0.78	0.84	Ke DN 16
44	60.82	327	361	427	488	569	630	743	263	0.80	0.85	Ke DN 25
46	66.48	357	395	466	534	622	689	812	240	0.81	0.85	Ke DN 25
50	78.54	422	467	551	631	735	814	959	221	0.83	0.86	Ke DN 25
55	95.03	511	565	667	764	889	985	1,161	168	0.84	0.87	Ke DN 25
60	113.10	608	673	794	909	1,059	1,172	1,381	141	0.85	0.87	Ke DN 25
65	132.73	714	789	932	1,067	1,243	1,376	1,621	120	0.85	0.87	Ke DN 32
70	153.94	828	916	1,080	1,237	1,441	1,596	1,880	100	0.90	0.88	Ke DN 32
75	176.71	950	1,051	1,240	1,420	1,654	1,832	2,159	90	0.86	0.88	Ke DN 32
80	201.06	1,081	1,196	1,411	1,616	1,882	2,084	2,456	79	0.87	0.88	Ke DN 40
85	226.98	1,221	1,350	1,593	1,825	2,125	2,353	2,773	70	0.87	0.88	Ke DN 40
90	254.47	1,369	1,514	1,786	2,046	2,383	2,638	3,109	62	0.87	0.88	Ke DN 40
95	283.53	1,525	1,687	1,990	2,279	2,655	2,940	3,464	56	0.87	0.88	Ke DN 50
100	314.16	1,690	1,869	2,205	2,526	2,942	3,257	3,838	50	0.88	0.89	Ke DN 50
115	415.48	2,235	2,472	2,917	3,340	3,890	4,308	5,076	38	0.88	0.89	Ke DN 65
125	490.87	2,641	2,921	3,446	3,946	4,596	5,090	5,998	32	0.89	0.89	Ke DN 65
135	572.56	3,080	3,407	4,020	4,603	5,361	5,937	6,996	26	0.89	0.89	Ke DN 65
142	633.47	3,408	3,769	4,448	5,093	5,932	6,568	7,740	20	0.89	0.89	Ke DN 65

Technical Data MfS 600 Single Pump 60 Hz

Plunger Ø	Stroke volume	Pump capacity Q _{th} in l/h per pump head at H/min [Identity code characteristic 3 to 9]:							Max. pressure	Efficiency at 100% pressure	Efficiency at 50% pressure	Standard type of valve
		96 [3]	109 [4]	120 [5]	142 [6]	163 [7]	189 [8]	210 [9]				
mm	ml/stroke	l/h	l/h	l/h	l/h	l/h	l/h	l/h	bar			
36	40.72	235	265	294	347	397	462	512	392	0.76	0.83	Ke DN 16
38	45.36	262	296	327	386	442	515	570	352	0.77	0.83	Ke DN 16
40	50.27	291	328	363	428	490	571	632	318	0.78	0.84	Ke DN 16
44	60.82	352	397	439	518	593	691	765	263	0.80	0.85	Ke DN 25
46	66.48	384	434	480	566	648	755	836	240	0.81	0.85	Ke DN 25
50	78.54	454	512	567	669	765	892	988	200	0.83	0.86	Ke DN 25
55	95.03	550	620	686	809	926	1,080	1,196	168	0.84	0.87	Ke DN 25
60	113.10	654	738	816	963	1,102	1,285	1,423	141	0.85	0.87	Ke DN 25
65	132.73	768	866	958	1,131	1,294	1,508	1,670	120	0.85	0.87	Ke DN 40
70	153.94	891	1,005	1,111	1,312	1,501	1,749	1,937	100	0.90	0.88	Ke DN 32
75	176.71	1,023	1,154	1,276	1,506	1,723	2,008	2,224	90	0.86	0.88	Ke DN 32
80	201.06	1,164	1,313	1,452	1,713	1,960	2,285	2,530	79	0.87	0.88	Ke DN 40
85	226.98	1,314	1,482	1,639	1,934	2,213	2,580	2,856	70	0.87	0.88	Ke DN 40
90	254.47	1,473	1,661	1,838	2,168	2,481	2,892	3,202	62	0.87	0.88	Ke DN 40
95	283.53	1,641	1,851	2,047	2,416	2,767	3,222	3,568	56	0.87	0.88	Ke DN 50
100	314.16	1,818	2,051	2,269	2,677	3,063	3,571	3,954	50	0.88	0.89	Ke DN 50
115	415.48	2,405	2,713	3,000	3,541	4,051	4,722	5,229	38	0.88	0.89	Ke DN 65
125	490.87	2,841	3,205	3,545	4,183	4,786	5,579	-	32	0.89	0.89	Ke DN 65
135	572.56	3,314	3,739	4,135	4,879	5,587	6,508	7,206	26	0.89	0.89	Ke DN 65
142	633.47	3,667	4,136	4,575	5,399	6,182	7,200	7,973	20	0.89	0.89	Ke DN 65

DK Double ball valve, Ke Conical valve

- Important note:**
- Abridged presentation of our complete product range. Other types on request
 - Allow for a minimum 10% power reserve when designing in accordance with API
 - All hydraulic performance data is based on water at 20 °C





2.12 Hydraulic Diaphragm Metering Pumps Orlita® MF

Identity Code Ordering System

Orlita® MFS 600 (MF5a) hydraulic diaphragm metering pump

MF5b	Drive type										
H1	Main drive horizontal *					AL	Drive module left-hand				
V1	Main drive vertical *					AR	Drive module right-hand				
Z1	Main drive central *					M	Modified **				
Plunger diameter											
036	36 mm	046	46 mm	065	65 mm	085	85 mm	115	115 mm		
038	38 mm	050	50 mm	070	70 mm	090	90 mm	125	125 mm		
040	40 mm	055	55 mm	075	75 mm	095	95 mm	135	135 mm		
044	44 mm	060	60 mm	080	80 mm	100	100 mm	142	142 mm		
Stroke rate 50 (60) Hz											
3	- (96) Strokes/min		5	99 (120) Strokes/min		7	134 (163) Strokes/min		9	173 (210) strokes/min	
4	90 (109) strokes/min		6	117 (142) Strokes/min		8	156 (189) Strokes/min		F	204 (-) Strokes/min	
Liquid end material (including valve materials)											
S1	Stainless steel (see table, sheet 2)										
Temperature of pumped medium											
0	-10 °C to 80 °C			2	-40 °C to 60 °C			4	10 °C to 150 °C		
1	-25 °C to 60 °C			3	10 °C to 115 °C						
Displacer format											
0	PTFE multi-layer diaphragm										
1	PTFE multi-layer diaphragm with pressure gauge										
Liquid end version											
0	Standard					2	Standard + double valve				
1	Standard with spring					3	Standard + double valve with spring				
Hydraulic connection suction side											
G	Thread DIN/ISO					A	Flange ANSI				
N	Thread NPT/ANSI					D	Flange DIN/ISO				
Hydraulic connection discharge side											
G	Thread DIN/ISO					A	Flange ANSI				
N	Thread NPT/ANSI					D	Flange DIN/ISO				
Version											
0	No features					2	Liquid end polished				
1	Liquid end heating					3	Special paint finish				
Power connector											
A	Standard voltage 50Hz										
B	Standard voltage 50Hz adjustable										
H	Standard voltage 60Hz										
K	Standard voltage 60Hz adjustable										
0	Externally mounted pump										
1	without motor with IEC flange										
2	without motor with NEMA flange										
Electrical protection system / explosion protection											
0	IP 55			D	IP 56 EExn						
1	IP 56			E	IP 56 EExe						
A	IP 55 EExn			F	IP 56 EExde						
B	IP 55 EExe			K	IP 65 EExde						
C	IP 55 EExde										
Electrical options											
0	no options										
1	Stroke sensor										
Stroke length adjustment											
0	manual										
1	0/4-20 mA without Ex										
2	0/4-20 mA Ex Zone 2										
3	0/4-20 mA Ex Zone 1										
4	0/4-20 mA Ex without EX offshore										
5	0/4-20 mA Ex Zone 2 offshore										
6	0/4-20 mA Ex Zone 1 offshore										
Environmental conditions											
0	-20 °C to 40 °C										
1	-40 °C to 40 °C										
2	0 °C to 55 °C										
Approvals											
0	CE										
1	API 675										
2	VDMA										
3	ATEX										
4	ATEX / API 675										
5	VDMA / ATEX										

*For further pump configurations see Type of drive page → 2-55

** Modified design (M) is available with every identity code feature

2.12 Hydraulic Diaphragm Metering Pumps Orlita® MF

2.12.7 Orlita® MFS 1400 (MF6a) Hydraulic Diaphragm Metering Pumps

Technical Data MfS 1400 Single Pump 50 Hz

Plunger Ø mm	Stroke volume ml/ stroke	Pump capacity Q _{th} in l/h per pump head at H/min [Identity code characteristic 4 to 9; F]:							Max. pressure bar	Efficiency at 100% pressure	Efficiency at 50% pressure	Standard type of valve
		80 [4] l/h	93 [5] l/h	106 [6] l/h	125 [7] l/h	143 [8] l/h	169 [9] l/h	191 [F] l/h				
30	42.41	202	235	270	318	364	431	486	630	0.67	0.78	Ke DN 16
40	75.40	360	419	480	565	647	766	864	435	0.75	0.83	Ke DN 25
42	83.13	397	462	529	623	713	844	952	435	0.76	0.83	Ke DN 25
44	91.23	435	507	581	684	783	927	1,045	394	0.76	0.83	Ke DN 25
46	99.71	476	554	635	748	856	1,013	1,142	361	0.77	0.83	Ke DN 25
50	117.81	562	654	750	884	1,011	1,197	1,350	305	0.79	0.84	Ke DN 25
53	132.37	632	735	843	993	1,136	1,345	1,517	271	0.79	0.84	Ke DN 32
55	142.55	681	792	907	1,070	1,224	1,448	1,633	250	0.81	0.85	Ke DN 25
57	153.11	731	851	975	1,149	1,314	1,556	1,754	235	0.81	0.85	Ke DN 32
60	169.65	810	943	1,080	1,273	1,456	1,724	1,944	212	0.82	0.86	Ke DN 25
65	199.10	951	1,106	1,268	1,494	1,709	2,023	2,282	180	0.83	0.87	Ke DN 32
70	230.91	1,103	1,283	1,470	1,733	1,983	2,346	2,646	155	0.84	0.87	Ke DN 40
75	265.07	1,266	1,473	1,688	1,989	2,276	2,694	3,038	135	0.85	0.87	Ke DN 40
80	301.59	1,440	1,676	1,920	2,263	2,590	3,065	3,456	119	0.85	0.87	Ke DN 40
90	381.70	1,823	2,121	2,431	2,865	3,278	3,879	4,375	94	0.90	0.90	Ke DN 50
100	471.24	2,251	2,619	3,001	3,537	4,047	4,789	5,401	76	0.87	0.88	Ke DN 65
120	678.58	3,242	3,772	4,321	5,093	5,827	6,896	7,778	53	0.88	0.89	Ke DN 65
140	923.63	4,412	5,134	5,882	6,933	7,932	9,387	10,587	38	0.88	0.89	Ke DN 80
160	1,206.37	5,763	6,706	7,683	9,055	10,360	12,261	13,827	29	0.89	0.89	Ke DN 80

Technical Data MfS 1400 Single Pump 60 Hz

Plunger Ø mm	Stroke volume ml/ stroke	Pump capacity Q _{th} in l/h per pump head at H/min [Identity code characteristic 3 to 9]:							Max. pressure bar	Efficiency at 100% pressure	Efficiency at 50% pressure	Standard type of valve
		88 [3] l/h	97 [4] l/h	112 [5] l/h	129 [6] l/h	152 [7] l/h	174 [8] l/h	206 [9] l/h				
30	42.41	223	245	286	327	386	442	523	630	0.67	0.78	Ke DN 16
40	75.40	396	437	508	582	686	785	930	435	0.75	0.83	Ke DN 25
42	83.13	437	482	560	642	757	866	1,025	435	0.76	0.83	Ke DN 25
44	91.23	480	529	615	705	831	951	1,125	394	0.76	0.83	Ke DN 25
46	99.71	524	578	672	770	908	1,039	1,230	361	0.77	0.83	Ke DN 25
50	117.81	619	683	794	910	1,073	1,228	1,453	305	0.79	0.84	Ke DN 25
53	132.37	696	767	893	1,023	1,206	1,379	1,632	271	0.79	0.84	Ke DN 32
55	142.55	750	826	961	1,102	1,298	1,486	1,758	250	0.81	0.85	Ke DN 25
57	153.11	805	887	1,033	1,183	1,394	1,596	1,888	235	0.81	0.85	Ke DN 32
60	169.65	892	983	1,144	1,311	1,545	1,768	2,092	212	0.82	0.86	Ke DN 25
65	199.10	1,047	1,154	1,343	1,539	1,814	2,075	2,456	180	0.83	0.87	Ke DN 32
70	230.91	1,214	1,339	1,558	1,785	2,103	2,407	2,848	155	0.84	0.87	Ke DN 40
75	265.07	1,394	1,537	1,788	2,049	2,415	2,763	3,270	135	0.85	0.87	Ke DN 40
80	301.59	1,586	1,748	2,035	2,331	2,747	3,143	3,720	119	0.85	0.87	Ke DN 40
90	381.70	2,008	2,213	2,575	2,950	3,477	3,979	4,200	94	0.90	0.90	Ke DN 50
100	471.24	2,479	2,732	3,179	3,642	4,293	4,912	4,708	76	0.87	0.88	Ke DN 65
120	678.58	3,570	3,935	4,578	5,245	6,182	7,073	8,371	53	0.88	0.89	Ke DN 65
140	923.21	4,859	5,356	6,232	7,140	8,415	9,628	-	38	0.88	0.89	Ke DN 80
160	1,206.37	6,347	6,995	8,140	9,325	10,991	12,575	-	29	0.89	0.89	Ke DN 80

DK Double ball valve
Ke Conical valve

- Important note:**
- Abridged presentation of our complete product range. Other types on request
 - Allow for a minimum 10% power reserve when designing in accordance with API
 - All hydraulic performance data is based on water at 20 °C





2.12 Hydraulic Diaphragm Metering Pumps Orlita® MF

Identity Code Ordering System

Orlita® MFS 1400 (MF6a) hydraulic diaphragm metering pump

MF6a	Drive type										
	H1	Main drive bare horizontal *	Z1	Main drive bare central *	AR	Drive module right-hand					
	V1	Main drive bare vertical *	AL	Drive module left-hand	M	Modified **					
Plunger diameter											
030	30 mm	046	46 mm	057	57 mm	075	75 mm	120	120 mm		
040	40 mm	050	50 mm	060	60 mm	080	80 mm	140	140 mm		
042	42 mm	053	53 mm	065	65 mm	090	90 mm	160	160 mm		
044	44 mm	055	55 mm	070	70 mm	100	100 mm	120	120 mm		
Stroke rate 50 (60) Hz											
3	- (88) Strokes/min		5	93 (112) Strokes/min		7	125 (152) Strokes/min		9	169 (206) strokes/min	
4	80 (97) strokes/min		6	106 (129) Strokes/min		8	143 (174) Strokes/min		F	191 (-)	
Liquid end material (including valve materials)											
S1	Stainless steel (see table, sheet 2)										
Temperature of pumped medium											
0	-10 °C to 80 °C			2	-40 °C to 60 °C			4	10 °C to 150 °C		
1	-25 °C to 60 °C			3	10 °C to 115 °C						
Displacer format											
0	PTFE multi-layer diaphragm										
1	PTFE multi-layer diaphragm with pressure gauge										
Liquid end version											
0	Standard		2	Standard + double valve							
1	Standard with spring		3	Standard + double valve with spring							
Hydraulic connection suction side											
G	Thread DIN/ISO				A	Flange ANSI					
N	Thread NPT/ANSI				D	Flange DIN/ISO					
Hydraulic connection discharge side											
G	Thread DIN/ISO				A	Flange ANSI					
N	Thread NPT/ANSI				D	Flange DIN/ISO					
Version											
0	no features		2	Liquid end polished							
1	Liquid end heating		3	Special paint finish							
Power connector											
A	Standard voltage 50Hz										
B	Standard voltage 50Hz adjustable										
H	Standard voltage 60Hz										
K	Standard voltage 60Hz adjustable										
0	Externally mounted pump										
1	without motor with IEC flange										
2	without motor with NEMA flange										
Electrical protection system / explosion protection											
0	IP 55	D	IP 56 EExn								
1	IP 56	E	IP 56 EExe								
A	IP 55 EExn	F	IP 56 EExde								
B	IP 55 EExe	K	IP 65 EExde								
C	IP 55 EExde										
Electrical options											
0	no options										
1	Stroke sensor										
Stroke length adjustment											
0	manual										
1	0/4-20 mA without Ex										
2	0/4-20 mA Ex Zone 2										
3	0/4-20 mA Ex Zone 1										
4	0/4-20 mA Ex without EX offshore										
5	0/4-20 mA Ex Zone 2 offshore										
6	0/4-20 mA Ex Zone 1 offshore										
Environmental conditions											
0	-20 °C to 40 °C										
1	-40 °C to 40 °C										
2	0 °C to 55 °C										
Approvals											
0	CE										
1	API 675										
2	VDMA										
3	ATEX										
4	ATEX / API 675										
5	VDMA / ATEX										

*For further pump configurations see Type of drive page → 2-55

** Modified design (M) is available with every identity code feature

2.13 Hydraulic Diaphragm Metering Pump Orlita® MH

2.13.1

Hydraulic Diaphragm Metering Pumps Orlita® MH with Metal Diaphragm

Reliable capacity even at very high pressure

Capacity range of single pump: up to 800 l/h, up to 700 bar

The diaphragm metering pump Orlita® MH has a robust metal diaphragm, which permits precise pump capacities even at very high pressure. The ORLITA® MH has a modular construction and therefore has a versatile range of uses. A range of power end versions are therefore available and drives, power ends and dosing heads can be freely combined.

ORLITA® MH hydraulic diaphragm metering pumps (MHS 18 to MHS 1400) with a stroke length of 15 to 60 mm provide a capacity range of up to 800 l/h at pressures of up to 7 bar. A wide range of drive versions is available, including some for use in Exe and Exde areas with ATEX certification. The Orlita® MF product range is designed to comply with API 675. Its modular construction permits the free combination of drives, power ends and dosing heads, producing a pump for a range of different feed rates and media operating at different working pressures.

Your benefits

Excellent process safety and reliability:

- Metal double diaphragm with integrated diaphragm rupture warning system ensures precise and low-wear operation even at very high pressure
- The product chamber is hermetically separated from the hydraulic part
- Integrated hydraulic relief valve and automatic bleed valve for the hydraulic chamber
- Wear-free, valveless enforced anti-cavitation of the hydraulic leakage guarantees optimum dosing precision
- Cone valves for use as suction and/or discharge valves with minimal wear, good self-cleaning and low pressure loss (NPSHR)

Excellent flexibility:

- It is possible to combine up to 6 metering units, even with different pump capacities, in multiple pump systems
- The modular construction ensures a wide range of uses
- 6 different gear ratios are available
- Power end configuration ideal for installation in any position (vertical or horizontal)
- Temperature range -60 °C to +200 °C
- Customised designs are available on request

Technical Details

- MHS 18 – Stroke length: 0-15 mm, Rod force: 1,750 N
- MHS 35 – Stroke length: 0-20 mm, Rod force: 3,500 N
- MHS 80 – Stroke length: 0-20 mm, Rod force: 14,000 N
- MHS 180 – Stroke length: 0-40 mm, Rod force: 18,000 N
- MHS 600 – Stroke length: 0-40 mm, Rod force: 40,000 N
- MHS 1400 – Stroke length: 0-60 mm, Rod force: 60,000 N
- Stroke length adjustment range: 0 – 100% in operation and idle.
- Stroke length adjustment: manually by means of a manual adjustment wheel and scaled display (optionally with electric actuator or control drive).
- Metering reproducibility is better than ± 0.5% within the stroke length adjustment range of 10 – 100% under defined conditions and with proper installation.
- Metal diaphragm with diaphragm rupture monitoring system
- Integrated hydraulic relief and bleed valve
- Wetted materials: Stainless steel, special designs are available on request
- A wide range of power end versions is available: Three-phase standard motors, motors for use in Exe and Exde areas and different flange designs for use in customer-specific motors
- Degree of protection: IP 55
- Temperature range - 60 °C to + 200 °C
- Design in compliance with API 675 among others

Field of application

- Oil/ gas production (onshore/offshore)
- Chemical/Petrochemical industry
- Pharmaceuticals & cosmetics
- Food production
- Packaging industry (bottling pumps)

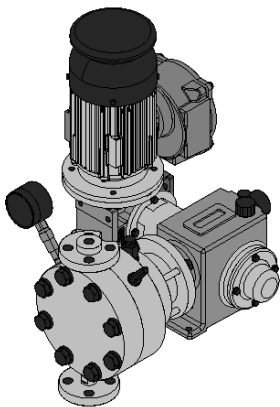

P_ORL_068_SW1
Orlita® MHS 18-20

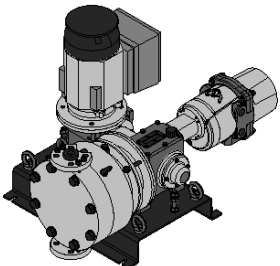

P_ORL_067_SW1
Orlita® MHS 35/45

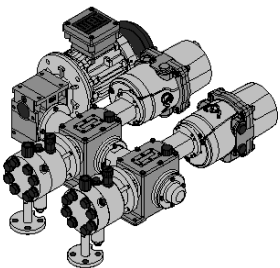

P_ORL_069_SW1
Orlita® MHS 35-8-8

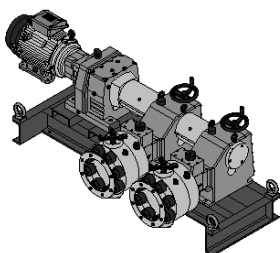

P_ORL_070_SW1
Orlita® MHS 600-28-28



2.13 Hydraulic Diaphragm Metering Pump Orlita® MH

Pump type	Plunger Ø	Stroke volume	Max. capacity (theo.) in l/h at strokes/min (50 Hz)						Max. pressure
			58	73	91	112	145	207	
	mm	ml/stroke	l/h	l/h	l/h	l/h	l/h	l/h	bar
MHS 18/	3	0.11	0.37	0.46	0.58	0.71	0.92	1.32	100
MHS 18/	5	0.29	1	1.2	1.6	1.9	2.5	3.6	400
MHS 18/	6	0.42	1.4	1.8	2.3	2.8	3.6	5.2	400
MHS 18/	7	0.58	2	2.5	3.1	3.8	5	7.1	400
MHS 18/	8	0.75	2.6	3.2	4.1	5	6.5	9.3	348
MHS 18/	10	1.18	4.1	5.1	6.4	7.8	10.2	14.6	222
MHS 18/	12	1.70	5.9	7.3	9.2	11.3	14.7	21	154
MHS 18/	16	3.02	10.5	13.1	16.4	20.1	26.2	37.4	87
MHS 18/	20	4.71	16.4	20.5	25.5	31.5	41	58.5	55

Pump type	Plunger Ø	Stroke volume	Max. capacity (theo.) in l/h at strokes/min (50 Hz)						Max. pressure
			58	73	91	112	145	207	
	mm	ml/stroke	l/h	l/h	l/h	l/h	l/h	l/h	bar
MHS 35/	7	0.77	2.6	3.3	4.1	5.1	6.7	9.5	900
MHS 35/	8	1.01	3.5	4.3	5.4	6.7	8.7	12.4	630
MHS 35/	10	1.57	5.4	6.8	8.5	10.5	13.6	19.5	445
MHS 35/	12	2.26	7.8	9.8	12.3	15.1	19.6	28.1	309
MHS 35/	14	3.08	10.7	13.3	16.7	20.6	26.7	38.2	227
MHS 35/	16	4.02	13.9	17.4	21.8	26.9	34.9	49.9	174
MHS 35/	18	5.09	17.7	22.1	27.6	34.0	44.2	63.2	137
MHS 35/	20	6.28	21.8	27.3	34.1	42.0	54.6	78.0	111
MHS 35/	22	7.60	26.4	33.0	41.3	50.8	66.1	94.4	92
MHS 35/	25	9.80	34.1	42.7	53.3	65.7	85.4	122.0	71
MHS 35/	36	20.36	70.8	88.5	110.6	136.2	177.1	253.0	34
MHS 35/	40	25.13	87.4	109.3	136.6	168.2	218.6	312.3	27
MHS 35/	45	31.81	110.6	138.3	172.9	212.8	276.7	395.3	22

Pump type	Plunger Ø	Stroke volume	Max. capacity (theo.) in l/h at strokes/min (50 Hz)						Max. pressure
			98	104	122	134	160	182	
	mm	ml/stroke	l/h	l/h	l/h	l/h	l/h	l/h	bar
MHS 80/	16	4.02	23.6	25.0	29.4	32.4	38.6	43.9	696
MHS 80/	18	5.09	29.9	31.7	37.2	41.0	48.8	55.5	550
MHS 80/	20	6.28	37.0	39.1	46.0	50.6	60.3	68.5	445
MHS 80/	22	7.60	44.7	47.4	55.6	61.3	73.0	82.9	368
MHS 80/	25	9.82	57.8	61.2	71.9	79.1	94.2	107.1	285

Pump type	Plunger Ø	Stroke volume	Max. capacity (theo.) in l/h at strokes/min (50 Hz)						Max. pressure
			99	117	134	156	173	204	
	mm	ml/stroke	l/h	l/h	l/h	l/h	l/h	l/h	bar
MHS 600/25.5	25.5	20.43	121	143	164	191	211	249	783
MHS 600/28	28	24.63	146	172	198	230	255	300	649
MHS 600/30	29.2	26.79	159	188	215	250	277	327	570
MHS 600/32	32	32.17	191	225	258	301	333	393	497

Pump type	Plunger Ø	Stroke volume	Max. capacity (theo.) in l/h at strokes/min (50 Hz)						Max. pressure
			93	106	125	143	169	191	
	mm	ml/stroke	l/h	l/h	l/h	l/h	l/h	l/h	bar
MHS 1400/	30	42.41	235	270	318	364	431	486	848
MHS 1400/	32	48.25	268	307	362	414	490	553	746
MHS 1400/	36	91.07	339	388	458	524	620	700	589
MHS 1400/	40	75.40	419	480	565	647	766	864	477

Important note:

Abridged presentation of our complete product range. Other types on request

2.14 Hydraulic Metal Diaphragm Metering Pump High-pressure Orlita® MHP

2.14.1

Hydraulic Metal Diaphragm Metering Pump High-pressure Orlita® MHP

Reliable capacity even at maximum pressure

Capacity range of single pump: 3 – 11 l/h, 3,000 bar

The metal diaphragm metering pumps Orlita® MHP are special pumps, which provide precise pump capacities even at maximum pressures of up to 3,000 bar.

The hydraulic metal diaphragm metering pumps ORLITA® MHRH 150 / MSH 600 have a metal diaphragm, which is designed to meter precisely at maximum pressures of up to 3,000 bar, thereby ensuring outstanding process reliability and safety.

Technical Details

- MSH: Stroke length: 0 – 40 mm, rod force: 40,000 N
- MHRH: Stroke length: 0 – 32 mm, rod force: 15,000 N
- Stroke length adjustment range: 0 – 100% in operation and idle
- Stroke length adjustment: manually by means of a manual adjustment wheel and scaled display (optionally with electric actuator or control drive)
- Metering reproducibility is better than ± 0.5 % within the 10 – 100 % stroke length range under defined conditions and with correct installation
- Metal diaphragm
- Integrated hydraulic relief and bleed valve
- Wetted materials: Stainless steel, special designs are available on request
- A wide range of power end/drive versions is available: Three-phase standard motors, motors for use in Exe and Exde areas and different flange designs for use in customer-specific motors
- Degree of protection: IP 55
- Temperature range -10 °C to +60 °C

Field of application

- Chemical/petrochemical industry
- Maximum pressure applications of up to 3,000 bar

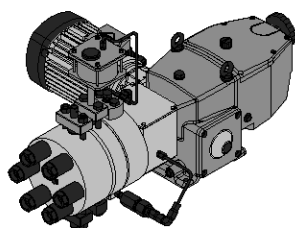

P_ORL_065_SW1
Orlita® MHR 150/7

Pump type	Plunger Ø mm	Stroke volume ml/stroke	Max. capacity (theo.) in l/h at strokes/min (50 Hz)				Max. pressure bar
			58 l/h	87 l/h	116 l/h	145 l/h	
MHRH 150/	6	0.90	3.1	4.7	6.3	7.8	3,000
MHRH 150/	7	1.23	4.2	6.4	8.5	10.7	3,000

Pump type	Plunger Ø mm	Stroke volume ml/stroke	Max. capacity (theo.) in l/h at strokes/min (50 Hz)					Max. pressure bar	
			90 l/h	99 l/h	117 l/h	134 l/h	156 l/h		173 l/h
MSSH 600/	10.5	3.46	18.6	20.6	24.3	27.8	32.4	35.9	3,000



2.15 Plunger Metering Pump Sigma/ 2 (Basic Type)

2.15.1

Plunger Metering Pump Sigma/ 2 (Basic Type)

Sigma plunger pump – durable and high-performance

Capacity range 2 – 76 l/h, 320 – 12 bar

The plunger metering pump Sigma/ 2 (Basic Type) is an extremely robust plunger metering pump with high-performance plunger and the option to adjust the pump capacity in 0.2% increments. It offers a wide range of power end versions, such as three-phase or 1-phase AC motors, even for Exe and Exde areas with ATEX certification.

The plunger metering pump Sigma/ 2 (Basic Type) (SBKa) is a metering pump, the pump capacity of which can be precisely adjusted in 0.2% increments, either manually or optionally with an electric actuator or control drive. A wide range of drive versions is available, including some for use in Exe and Exde areas with ATEX certification.

Your benefits

Excellent process safety and reliability:

- Metering reproducibility is better than $\pm 1\%$ within the 10 – 100% stroke length range under defined conditions and with correct installation

Flexible adaptation to the process:

- Wide range of power end versions, also for use in Exe and Exde areas and different flange designs for the use of customised motors
- Customised designs are available on request

Technical Details

- Stroke length: 15 mm
- Stroke length adjustment range: 0 – 100 %
- Stroke length adjustment: manually by self-locking rotary dial in 0.2 % increments (optionally with electric actuator or control drive)
- Metering reproducibility is better than $\pm 1\%$ within the 10 - 100 % stroke volume adjustment range under certain defined conditions and with correct installation
- Wetted materials: Stainless steel 1.4571/1.4404, special materials are available on request
- High-performance oxide ceramic plunger
- A wide range of power end versions is available: Three-phase standard motor, 1-phase AC motor, motors for use in Exe and Exde areas and different flange designs for use in customer-specific motors
- Degree of protection IP 55
- Highly rigid fibreglass-reinforced plastic housing with excellent chemical resistance
- Provide suitable overload protection in all plunger metering pumps during installation for safety reasons

Field of application

- Volume-proportional metering of chemicals in the treatment of boiler feed water
- Metering of reactants and catalysts in the chemical industry
- Level-dependent metering of auxiliary agents in industrial production engineering, for instance hot wax metering in the production of adhesive strips

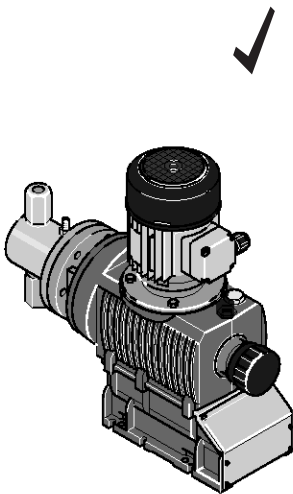

pk_2_006
Sigma Basic Type SBKa

2.15 Plunger Metering Pump Sigma/ 2 (Basic Type)

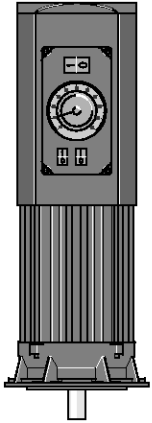

pk_2_103
Variable speed motor with integrated frequency converter

Sigma Basic Type Control Functions

Stroke length actuator/controller

Actuator for automatic stroke length adjustment, actuating period approx. 1 sec for 1% stroke length, 1 k Ω response signal potentiometer, enclosure rating IP 54.

Controller consists of actuator with servomotor and integrated servo control for stroke length adjustment via a standard signal. Standard signal input 0/4-20 mA corresponds to stroke length 0 - 100%. Automatic/manual operation selection key for manual stroke adjustment. Mechanical status display of actual stroke length value output 0/4-20 mA for remote display.

Variable speed motors with integrated speed controller (identity code specification V)

Power supply 1 ph 230 V, 50/60 Hz, 0.37 kW.

External control with 0/4-20 mA (see pk_2_103)

(Speed Controllers see p. → 1-82)

Speed controllers in metal housing (identity code specification Z)

The speed controller assembly consists of a frequency converter and a variable speed motor of 0.37 kW.

(Speed Controllers see p. → 1-82)





2.15 Plunger Metering Pump Sigma/ 2 (Basic Type)

Technical Data

Type SBKa	With 1500 rpm motor at 50 Hz				With 1800 rpm motor at 60 Hz				Suction lift m WC	Perm. pre- pressure suction side bar	Connector Suction/ Discharge Side Rp-DN	Shipping weight kg	Plunger Ø mm
	Delivery rate at max. back pressure		Max. stroke rate Strokes/ min	Delivery rate at max. back pressure		Max. stroke rate Strokes /min							
	bar	l/h		ml/ stroke	psi		l/h	gph (US)					
32002	320	1.9	0.46	71	4,641	2.3	0.61	84	5.0	160	1/4	24	8
23004	230	4.0	0.52	129	3,336	4.8	1.27	154	5.0	115	1/4	24	8
10006	100	6.4	0.55	195	1,450	7.6	2.01	233	5.0	50	1/4	24	8
14006	140	6.1	1.42	71	2,031	7.1	1.88	84	4.0	70	1/4	24	12
10011	100	11.0	1.43	129	1,450	13.1	3.46	153	4.0	50	1/4	24	12
05016	50	16.7	1.43	195	725	20.0	5.28	233	4.0	25	1/4	24	12
07012	70	12.4	2.90	71	1,015	14.8	3.91	85	4.0	35	1/4	24	17
04522	45	22.5	2.91	129	653	26.7	7.05	153	4.0	22.5	1/4	24	17
02534	25	34.1	2.92	195	363	40.8	10.78	233	4.0	12.5	1/4	24	17
04022	40	22.4	5.26	71	580	26.5	7.00	84	4.0	20	3/8	25	23
02541	25	41.5	5.37	129	363	49.2	13.00	153	4.0	12.5	3/8	25	23
01264	12	64.0	5.45	195	174	76.0	20.08	233	4.0	6	3/8	25	23

Materials in Contact With the Medium

Material	Dosing head	Suction/pressure connector	Seals/ball seat	Balls	Ball seat
SST	Stainless steel 1.4404	Stainless steel 1.4404	PTFE or PTFE +25% carbon	Ceramic	Stainless steel 1.4404

Motor Data

Identity code specification		Power supply			Remarks
S	3 ph, IP 55	220-240 V/380-420 V 250-280 V/440-480 V	50 Hz 60 Hz	0.25 kW	
R	3 ph, IP 55	230 V/400 V	50/60 Hz	0.37 kW	with PTC, speed adjustment range 1:20 with external fan 1 ph 230 V; 50/60Hz
V0	1 ph, IP 55	230 V ±5%	50/60 Hz	0.37 kW	Variable speed motor with integrated frequency converter
M	1 ph AC, IP 55	230 V ±5%	50/60 Hz	0.18 kW	
N	1 ph AC, IP 55	115 V ±5%	60 Hz	0.18 kW	
L1	3 ph, II2GEEexII T3	220-240 V/380-420 V	50 Hz	0.18 kW	
L2	3 ph, II2GEEexdII CT4	220-240 V/380-420 V	50 Hz	0.18 kW	with PTC, speed control range 1:5
P1	3 ph, II2GEEexII T3	250-280 V/440-480 V	60 Hz	0.18 kW	
P2	3 ph, II2GEEexdII CT4	250-280 V/440-480 V	60 Hz	0.21 kW	with PTC, speed control range 1:5

Motor data sheets can be requested for more information.

Special motors or special motor flanges are possible on request.

The motors are designed in compliance with the Ecodesign Directive 2009/125/EC.

Information for use in areas at risk from explosion

Only use pumps with the appropriate labelling in line with the ATEX Directive 94/9/EC in premises at risk from explosion. Ensure that the explosion group, category and degree of protection specified on the label corresponds to or is better than the conditions prevalent in the intended field of application.

2.15 Plunger Metering Pump Sigma/ 2 (Basic Type)

2.15.2 Identity Code Ordering System for SBKa

Sigma Basic Type SBKa

SBKa	Drive type		
HK	Main drive, plunger		
	Type	bar	l/h
		32002	320 1.9
		23004	230 4.0
		10006	100 6.4
		14006	140 6.1
		10011	100 11.0
		05016	50 16.7
		07012	70 12.4
		04522	45 22.5
		02534	25 34.1
		04022	40 22.4
		02541	25 41.5
		01264	12 64.0
	Liquid end material		
	SS	Stainless steel	
	Sealing material*		
	T	PTFE	
	Displacement body*		
	4	Plunger (oxide ceramic)	
	Liquid end version		
	0	No spring (standard)	
	1	With 2 valve springs, Hastelloy C, 0.1 bar	
	Hydraulic connection		
	0	Standard threaded connector (according to technical data)	
	Version		
	0	With ProMinent® logo (standard)	
	1	Without ProMinent® logo	
	M	Modified	
	Electrical power supply		
	S	3 ph, 230 V/400 V 50/60 Hz, 0.18 kW	
	R	3 ph, variable speed motor, 230/400 V, 0.37 kW	
	V (0)	Variable speed motor with integrated SC 1 pH, 230 V, 50/60 Hz	
	Z	1 ph, variable speed set 230 V, 50/60 Hz	
	M	1 ph, AC, 230 V/ 50/60 Hz, 0.18 kW	
	N	1 ph, AC 115 V 60 Hz, 0.18 kW	
	L	3 ph, 230 V/400 V, 50 Hz, (EExe, EExd), 0.18 kW	
	P	3 ph, 230 V/400 V, 60 Hz, (EExe, EExd), 0.18 kW	
	1	No motor, with B 14 flange (size 71 (DIN))	
	2	No motor, C 56 flange (NEMA)	
	3	No motor, B 5 size 63 (DIN)	
	Enclosure rating		
	0	IP 55 (standard)	
	1	Exe motor version ATEX-T3	
	2	Exd motor version ATEX-T4	
	A	ATEX power end	
	Stroke sensor		
	0	No stroke sensor (standard)	
	2	Pacing relay (reed relay)	
	3	Stroke sensor (Namur) for hazardous locations	
	Stroke length adjustment		
	0	Manual (standard)	
	1	With stroke positioning motor, 230 V/50/60 Hz	
	2	With stroke positioning motor, 115 V/50/60 Hz	
	3	With stroke control motor 0...20 mA 230 V/50/60 Hz	
	4	With stroke control motor 4...20 mA 230 V/50/60 Hz	
	5	With stroke control motor 0...20 mA 115 V/50/60 Hz	
	6	With stroke control motor 4...20 mA 115 V/50/60 Hz	

2



2.15 Plunger Metering Pump Sigma/ 2 (Basic Type)

2.15.3 Spare Parts Kits

Consisting of: 1 ceramic metering plunger, 4 valve balls, 4 ball seat discs, 2 PTFE/graphite ball seals, 2 plunger guides, 14 flat seals, 2 O-rings.

	Type	Order no.
Liquid end FK 08	Applies to identity code: 32002, 23004, 10006	1001572
Liquid end FK 12.5	Applies to identity code: 14006, 10011, 05016	910470
Liquid end FK 25	Applies to identity code: 07012, 04522, 02534	910471
Liquid end FK 50	Applies to identity code: 04022, 02541, 01264	910472



2.16 Plunger Metering Pump Sigma/ 2 (Control Type)

2.16.1 Plunger Metering Pump Sigma/ 2 (Control Type)

Sigma plunger pump – durable, high-performance and intelligent.

Capacity range 2 – 76 l/h, 320 – 12 bar

The plunger metering pump Sigma/2 (Control Type) is an extremely robust metering pump with integral control for analogue and/or contact operation. It offers the option of adjusting the pump capacity in 0.2% increments. It offers a wide range of power end versions, and different flange designs.

The plunger metering pump Sigma/ 2 (Control Type) (SCKa) is a metering pump, the pump capacity of which can be precisely adjusted in 0.2% increments, either manually or optionally with an electric actuator or control drive. The integrated controller allows the pump to adapt quickly and reliably to changing metering tasks.

Your benefits

Process reliability:

- Metering reproducibility is better than $\pm 1\%$ within the 10 – 100% stroke length range under defined conditions and with correct installation

Flexible adaptation to the process:

- The integrated controller allows the pump to adapt quickly and reliably to changing metering tasks
- Customised designs are available on request

Technical Details

- Stroke length: 15 mm
- Stroke length adjustment range: 0 – 100%
- Stroke length adjustment: manually by self-locking rotary dial in 0.2% increments (optionally with electric actuator or control drive)
- Metering reproducibility is better than $\pm 1\%$ within the 10-100% stroke length adjustment range under certain defined conditions and with proper installation
- Wetted materials: Stainless steel 1.4571/1.4404, special materials are available on request
- High-performance oxide ceramic plunger
- Integrated control for analogue and/or contact operation
- Power supply: 1-phase, 100 – 230 V $\pm 10\%$, 240 V $\pm 6\%$, 50/60 Hz (220 W)
- Degree of protection IP 55
- Highly rigid fibreglass-reinforced plastic housing with excellent chemical resistance
- Provide suitable overload protection in all plunger metering pumps during installation for safety reasons

Field of application

- Volume-proportional metering of chemicals in the treatment of boiler feed water
- Metering of reactants and catalysts in the chemical industry
- Level-dependent metering of auxiliary agents in industrial production engineering, for instance hot wax metering in the production of adhesive strips

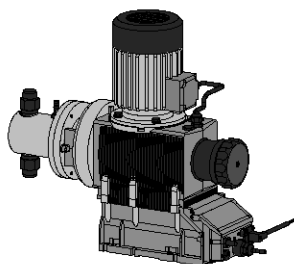

P_ORL_066_SW1
Sigma control type SCKa

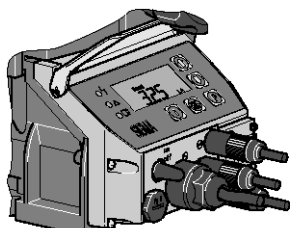

pk_2_104
Sigma Controller



2.16 Plunger Metering Pump Sigma/ 2 (Control Type)

Technical Data

Type	Delivery rate at max. back pressure		With 1800 rpm motor at 60 Hz				Suction lift	Perm. pre-pressure suction side	Connector Suction/ Discharge Side	Shipping weight	Plunger Ø
			Delivery rate at max. back pressure		Max. stroke rate						
	bar	ml/stroke	psi	l/h	gph (US)	Strokes/min	m WC	bar	Rp-DN	kg	mm
32002	320	0.46	4,641	2.3	0.61	84	5.0	160	1/4	24	8
23004	230	0.52	3,336	4.8	1.27	154	5.0	115	1/4	24	8
10006	100	0.55	1,450	7.6	2.01	233	5.0	50	1/4	24	8
14006	140	1.42	2,031	7.1	1.88	84	4.0	70	1/4	24	12
10011	100	1.43	1,450	13.1	3.46	153	4.0	50	1/4	24	12
05016	50	1.43	725	20.0	5.28	233	4.0	25	1/4	24	12
07012	70	2.90	1,015	14.8	3.91	85	4.0	35	1/4	24	17
04522	45	2.91	653	26.7	7.05	153	4.0	22.5	1/4	24	17
02534	25	2.92	363	40.8	10.78	233	4.0	12.5	1/4	24	17
04022	40	5.26	580	26.5	7.00	84	4.0	20	3/8	25	23
02541	25	5.37	363	49.2	13.00	153	4.0	12.5	3/8	25	23
01264	12	5.45	174	65.4	17.28	200	4.0	6	3/8	25	23

Materials in Contact With the Medium

Material	Dosing head	Suction/pressure connector	Seals/ball seat	Balls	Ball seat
SST	Stainless steel 1.4404	Stainless steel 1.4404	PTFE or PTFE +25% carbon	Ceramic	Stainless steel 1.4404

Motor Data

Identity code specification	Power supply	Remarks
U	1-phase, IP 55 100 – 230 V ±10%, 240 V ±6%, 50/60 Hz 220 W	

The motors are designed in compliance with the Ecodesign Directive 2009/125/EC.

Information for use in areas at risk from explosion

Only use pumps with the appropriate labelling in line with the ATEX Directive 94/9/EC in premises at risk from explosion. Ensure that the explosion group, category and degree of protection specified on the label corresponds to or is better than the conditions prevalent in the intended field of application.

2.16 Plunger Metering Pump Sigma/ 2 (Control Type)

2.16.2 Identity Code Ordering System for SCKa

Sigma Control Type SCKa

SCKa	Drive type		
HK	Main drive, plunger		
	Type	bar	l/h
		32002	320 2.3
		23004	230 4.8
		10006	100 6.4
		14006	140 7.1
		10011	100 13.1
		05016	50 16.7
		07012	70 14.8
		04522	45 26.7
		02534	25 34.1
		04022	40 26.5
		02541	25 49.2
		01264	12 64.0
	Liquid end material		
	SS	Stainless steel	
	Sealing material*		
	T	PTFE	
	Displacement body*		
	4	Plunger (oxide ceramic)	
	Liquid end version		
	0	No spring (standard)	
	1	With 2 valve springs, Hastelloy C 4, 0.1 bar	
	Hydraulic connection		
	0	Standard threaded connector (according to technical data)	
	Version		
	0	With ProMinent® logo	
	1	Without ProMinent® logo	
	Electrical power supply		
	U	1 ph 100-230 V ±10%, 50/60 Hz	
	Cable and plug		
	A	2 m European	
	B	2 m Swiss	
	C	2 m Australian	
	D	2 m USA	
	Relay		
	0	No relay	
	1	With fault indicating relay 1x changeover 230 V – 2A	
	3	With fault indicating relay 1x changeover 230 V – 2A	
	4	As 1 + pacing relay 2x normally open 24 V - 100 mA	
	5	As 3 with pacing relay 2x normally open 24 V - 100 mA	
	A	Shut-off and warning relays normally closed 2x normally open 24 V - 100 mA	
	F	Power relay normally closed 1x changeover 230 V - 8 A	
	Control variant		
	0	Manual + external with pulse control	
	1	Manual + external + pulse control + analogue	
	Access code		
	0	No access code	
	1	With access code	
	Metering monitor		
	0	Input with pulse evaluation	
	1	Input with cont. evaluation	
	Stroke length adjustment		
	0	Manual	

2.16.3 Spare Parts Kits

Consisting of: 1 ceramic metering plunger, 4 valve balls, 4 ball seat discs, 2 PTFE/graphite ball seals, 2 plunger guides, 14 flat seals, 2 O-rings.

	Type	Order no.
Liquid end FK 08	Applies to identity code: 32002, 23004, 10006	1001572
Liquid end FK 12.5	Applies to identity code: 14006, 10011, 05016	910470
Liquid end FK 25	Applies to identity code: 07012, 04522, 02534	910471
Liquid end FK 50	Applies to identity code: 04022, 02541, 01264	910472



2.17 Plunger Metering Pump Meta

2.17.1

Plunger Metering Pump Meta

Meta plunger pump – durable and high-performance

Capacity range 6 – 59 l/h, 216 – 52 bar

The extremely high-performance Meta is a plunger metering pump with the option of adjusting the pump capacity in 0.2% increments. It offers a wide range of power end versions, such as three-phase or 1-phase AC motors, even for Exe and Exde areas with ATEX certification.

The Meta (MTKa) is a plunger metering pump, the pump capacity of which can be precisely adjusted in 0.2% increments, either manually or optionally with an electric actuator or control drive. A wide range of drive versions is available, including some for use in Exe and Exde areas with ATEX certification.

Your benefits

Excellent process safety and reliability:

- Metering reproducibility is better than $\pm 0.5\%$ within the 10 – 100% stroke length range under defined conditions and with correct installation

Flexible adaptation to the process:

- Wide range of power end versions, also for use in Exe and Exde areas and different flange designs for the use of customised motors
- Customised designs are available on request

Technical Details

- Stroke length: 15 mm,
- Stroke length adjustment range: 0 – 100%
- Stroke length adjustment: manually by self-locking rotary dial in 0.2% increments (optionally with electric actuator or control drive)
- Metering reproducibility is better than $\pm 1\%$ within the 10-100% stroke length adjustment range under certain defined conditions and with proper installation
- Wetted materials: Stainless steel 1.4571/1.4404
- High-performance oxide ceramic plunger
- A wide range of power end versions is available: Three-phase standard motor, 1-phase AC motor, motors for use in Exe and Exde areas and different flange designs for use in customer-specific motors
- Degree of protection IP 55
- Fibreglass-reinforced plastic housing
- Provide suitable overload protection in all plunger metering pumps during installation for safety reasons.

Field of application

- Volume-proportional metering of chemicals in the treatment of boiler feed water
- Metering of reactants and catalysts in the chemical industry
- Level-dependent metering of auxiliary agents in industrial production engineering, for instance hot wax metering in the production of adhesive strips

Control of Meta Piston Metering Pumps

(Speed Controllers see p. → 1-82)

Speed controllers in metal housing (Identity code characteristic Z)

Frequency changer built into IP 54 protective housing and main switch designed for max. 0.37 kW motor output.

Externally controlled with 0/4-20 mA / 0-10 V to correspond to 0-50 (60) Hz output frequency.

Integrated controller with versatile functions e.g. switching between external/internal control. With internal control, frequency input is via arrow keys. Multi lingual fault message display and motor temperature monitoring (thermistor-protection).

The speed controller assembly consists of a speed controller and a variable speed motor (see also identity code characteristic R).

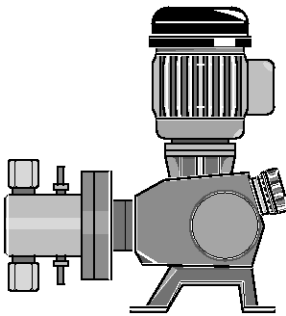

pk_2_010
Meta plunger metering pump MTKa

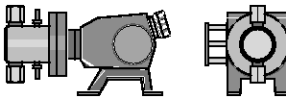

pk_2_011
Meta plunger metering pump MTKa

2.17 Plunger Metering Pump Meta

Technical Data

Type MTKa	With 1500 rpm motor at 50 Hz				With 1800 rpm motor at 60 Hz			Suction lift m WC	Perm. pre- pressure suction side bar	Connector Suction/ Discharge Side Rp-DN	Motor rating W	Ship- ping weight kg	Plunger Ø mm
	Delivery rate at max. back pressure		Max. stroke rate /min	Delivery rate at max. back pressure		Max. stroke rate /min							
	bar	l/h		m/ stroke	psi		l/h/gph (US)						
21606	216	6.1	1.42	72	3,130	7.3/1.9	86	4.0	108	1/4	180	18	12
24006	240	6.1	1.42	72	3,477	7.3/1.9	86	4.0	120	1/4	370	20	12
16208	162	8.1	1.42	96	2,347	9.8/2.6	115	4.0	81	1/4	180	18	12
22508	225	8.1	1.42	96	3,260	9.8/2.6	115	4.0	112.5	1/4	370	20	12
12910	129	10.2	1.42	120	1,878	12.2/3.2	144	4.0	64.5	1/4	180	18	12
21610	216	10.2	1.42	120	3,130	12.2/3.2	144	4.0	108	1/4	370	20	12
10812	108	12.2	1.42	144	1,565	14.7/3.9	173	4.0	54	1/4	180	18	12
21012	210	12.2	1.42	144	3,043	14.7/3.9	173	4.0	105	1/4	370	20	12
10213	102	13.0	3.01	72	1,479	15.6/4.1	86	4.0	51	1/4	180	18	17
11313	113	13.0	3.01	72	1,644	15.6/4.1	86	4.0	56.5	1/4	370	20	17
07617	76	17.3	3.01	96	1,109	20.8/5.5	115	4.0	38	1/4	180	18	17
10617	106	17.3	3.01	96	1,541	20.8/5.5	115	4.0	53	1/4	370	20	17
06122	61	21.7	3.01	120	888	26.0/6.9	144	4.0	30.5	1/4	180	18	17
10222	102	21.7	3.01	120	1,479	26.0/6.9	144	4.0	51	1/4	370	20	17
05126	51	26.0	3.01	144	740	31.2/8.2	173	4.0	25.5	1/4	180	18	17
09926	99	26.0	3.01	144	1,438	31.2/8.2	173	4.0	49.5	1/4	370	20	17
05425	54	24.6	5.71	72	782	29.5/7.8	86	4.0	27	3/8	180	18	23
06025	60	24.6	5.71	72	869	29.5/7.8	86	4.0	30	3/8	370	20	23
04033	40	32.8	5.71	96	587	39.4/10.4	115	4.0	20	3/8	180	18	23
05633	56	32.8	5.71	96	815	39.4/10.4	115	4.0	28	3/8	370	20	23
03241	32	41.1	5.71	120	469	49.3/13.0	144	4.0	16	3/8	180	18	23
05441	54	41.1	5.71	120	782	49.3/13.0	144	4.0	27	3/8	370	20	23
02749	27	49.3	5.71	144	391	59.2/15.6	173	4.0	13.5	3/8	180	18	23
05249	52	49.3	5.71	144	761	59.2/15.6	173	4.0	26	3/8	370	20	23

Materials in Contact With the Medium

Material	Dosing head	Suction/pressure connector	Seals	Valve balls	Valve seat	Plunger
SST	Stainless steel 1.4404	Stainless steel 1.4404	PTFE or PTFE + 25 % carbon	Ceramic	Stainless steel 1.4404	Ceramic

Motor Data

Identity code specification	Power supply	Remarks
S	3 ph, IP 55 220-240 V/380-420 V 250-280 V/440-480 V	50 Hz 0.18/0.37 kW 60 Hz 0.18/0.37 kW
R	3 ph, IP 55 230 V/400 V	50/60 Hz 0.37 kW With PTC, speed adjustment range 1:20 with external fan 1 ph 230 V; 50/60Hz
M	1 ph AC, IP 55 230 V ±5%	50/60 Hz 0.37 kW
N	1 ph AC, IP 55 115 V ±5%	60 Hz 0.37 kW
L1	3 ph, II2GEEExIICT3	220-240 V/380-420 V 50 Hz 0.18/0.37 kW
L2	3 ph, II2GEEExIICT4	220-240 V/380-420 V 50 Hz 0.18/0.37 kW With PTC, speed control range 1:5
P1	3 ph, II2GEEExIICT3	250-280 V/440-480 V 60 Hz 0.18/0.37 kW
P2	3 ph, II2GEEExIICT4	250-280 V/440-480 V 60 Hz 0.18/0.37 kW With PTC, speed control range 1:5

The motor power is dependent on the pump type (see technical data).

Motor data sheets can be requested for more information.

Special motors or special motor flanges are possible on request.

The motors are designed in compliance with the Ecodesign Directive 2009/125/EC.

Information for use in areas at risk from explosion

Only use pumps with the appropriate labelling in line with the ATEX Directive 94/9/EC in premises at risk from explosion. Ensure that the explosion group, category and degree of protection specified on the label corresponds to or is better than the conditions prevalent in the intended field of application.



2.17 Plunger Metering Pump Meta

2.17.2 Identity Code Ordering System for MTKa

Meta piston metering pump, version a

MTKa	Drive type		
H	Main drive		
A	Add-on drive		
Type			
	bar	l/h	
21606	216	6.1	
24006	240	6.1	
16208	162	8.1	
22508	225	8.1	
12910	129	10.2	
21610	216	10.2	
10812	108	12.2	
21012	210	12.2	
10213	102	13.0	
11313	113	13.0	
07617	76	17.3	
10617	106	17.3	
06122	61	21.7	
10222	102	21.7	
05126	51	26.0	
09926	99	26.0	
05425	54	24.6	
06025	60	24.6	
04033	40	32.8	
05633	56	32.8	
03241	32	41.1	
05441	54	41.1	
02749	27	49.3	
05249	52	49.3	
Liquid end material			
SS	Stainless steel		
Sealing material*			
T	PTFE		
Displacement body*			
S	Standard plunger, oxide ceramic		
Liquid end version			
0	No valve springs		
1	With 2 valve springs, Hastelloy C, 0.1 bar		
Hydraulic connection			
0	Standard threaded connector (according to technical data)		
Version			
0	With ProMinent® logo (standard)		
1	Without ProMinent® logo		
M	Modified		
Electrical power supply			
S	3 ph, 230 V/400 V, 50/60 Hz (WBS)		
R	3 ph, variable speed motor, 230 V/400 V		
Z	1 ph, variable speed set 230 V, 50/60 Hz		
M	1 ph, AC, 230 V, 50/60 Hz		
N	1 ph, AC, 115 V, 60 Hz		
L	3 ph, 230 V/400 V, 50 Hz, (Exe, Exd)		
P	3 ph, 230 V/400 V, 60 Hz, (Exe, Exd)		
1	No motor, with flange 90/63		
2	No motor, with flange 140/71		
3	No motor, with flange 160/71		
4	No motor, with flange 56 C		
0	Add-on pump (no motor)		
Enclosure rating			
0	IP 55 (standard)		
1	Exe motor version ATEX-T3		
2	Exd motor version ATEX-T4		
A	ATEX power end		
Stroke sensor			
0	No stroke sensor (standard)		
1	With stroke sensor, Namur signal (Ex)		
Stroke length adjustment			
0	Manual (standard)		
2	With stroke positioning, 115 V/50/60 Hz		
A	With stroke control motor 0...20 mA 230 V/50/60 Hz		
B	With stroke control motor 4...20 mA 230 V/50/60 Hz		
C	With stroke control motor 0...20 mA 115 V/50/60 Hz		
D	With stroke control motor 4...20 mA 115 V/50/60 Hz		



2.17 Plunger Metering Pump Meta

2.17.3

Spare Parts

Spare Parts Kits for Plunger Metering Pump Meta (MTKa)

Consisting of:

- 1 ceramic plunger
- 4 valve balls
- 4 ball seat discs
- 2 PTFE /graphite plunger packing rings
- 2 plunger guide bands
- 14 flat seals
- 2 O-rings

Order no.

Liquid end FK 12.5 Applies to identity code: 21606, 24006, 16208, 22508, 12910, 21610, 10812, 21012	910470
---	--------

Liquid end FK 25 applies to identity code: 10213, 11313, 07617, 10617, 06122, 10222, 05126, 09926	910471
---	--------

Liquid end FK 50 applies to identity code: 05425, 06025, 04033, 05633, 03241, 05441, 02749, 05249	910472
---	--------

Mounting Frame for Meta MTMa and MTKa

A base frame is available for main and add-on pump combinations.

Order no.

Base frame for main and one add-on pump	803897
---	--------

Base frame for main and two add-on pumps	803898
--	--------

Base frame for main and three add-on pumps	803899
--	--------



2.18 Plunger Metering Pump Makro TZ

2.18.1

Plunger Metering Pump Makro TZ

Powerful, built to last with a plunger

Capacity range of single pump: 8 – 1,141 l/h, 320 – 11 bar

The plunger metering pump Makro TZ impresses with its excellent process reliability, outstanding flexibility and its modular construction enables it to be outstandingly adapted to the performance requirements of the respective application.

The plunger metering pump Makro TZ (TZKa) has an adjustable eccentric drive mechanism and, together with the Makro TZ diaphragm metering pump, forms a range of drive mechanisms with stroke lengths of 10 and/or 20 mm. This covers the capacity range from 8 to 2,100 l/h at 320 – 4 bar. A wide range of drive versions is available, including some for use in Exe and Exde areas with ATEX certification.

Your benefits

Process reliability:

- Metering reproducibility is better than $\pm 0.5\%$ within the 10 – 100% stroke length range under defined conditions and with correct installation

Excellent flexibility:

- The modular construction with single and double head versions permits a wide range of applications, with the double head designs being operated in push-pull mode
- It is possible to combine up to 4 metering units, even with different pump capacities, in multiple pump systems
- 4 different gear ratios are available
- Customised designs are available on request

Technical Details

- Stroke length: 0-20 mm, Rod force: 8,000 N
- Stroke length adjustment range: 0 – 100%
- Stroke length adjustment: manually by means of shift ring in 0.5% increments (optionally with electric actuator or control drive)
- Metering reproducibility is better than $\pm 0.5\%$ within the stroke length adjustment range of 10 – 100% under defined conditions and with proper installation. Observe the information in the operating instructions.
- High-performance ceramic-coated stainless steel plunger Wetted materials: Stainless steel 1.4571. Special materials are available on request
- A wide range of power end versions is available: three-phase standard motors, motors for use in Exe and Exde areas and different flange designs for use in customer-specific motors
- Degree of protection: IP 55
- Salt water-resistant, acrylic resin-coated cast aluminium housing
- Provide suitable overload protection in all plunger metering pumps during installation for safety reasons

Field of application

- Volume-proportional metering of chemicals/additives in water treatment
- Metering of reactants and catalysts in the chemical industry
- Level-dependent metering of additives in industrial production engineering

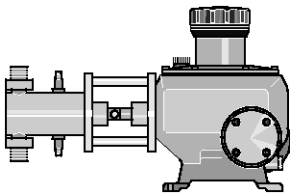

pk_2_019
Makro TZ plunger metering pump

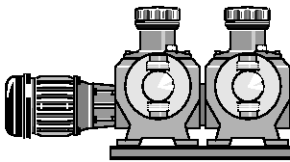

pk_2_018
Makro TZ TZKa externally mounted pump

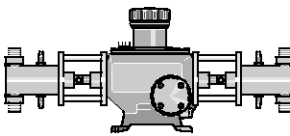

pk_2_020
Makro TZ TZKa double head pump



2.18 Plunger Metering Pump Makro TZ

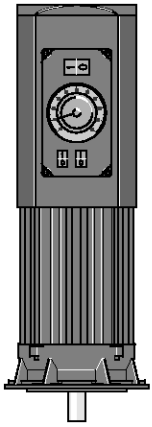

pk_2_103
Variable speed motor with integrated frequency converter

Makro TZ Metering Pump Actuators

Makro TZ stroke length actuator/control drive

Makro TZ actuator

Servomotor for automatic stroke length adjustment, actuating period approx. 1 sec for 1 % stroke length, including 1 k Ω feedback potentiometer for stroke position response signal, IP 54 degree of protection. Electrical connection 230 V (± 10 %), 50/60 Hz, 40 W mech. stroke length display fitted on the Makro TZ power end.

Special voltage/higher degrees of protection/explosion protection upon request.

Makro TZ control drive

Control drive consisting of an actuator with servomotor and integral microprocessor controller for stroke length adjustment via a standard signal. Technical data see actuator.

Design:

Standard signal current input 0/4-20 mA corresponds to stroke length 0 -100 %, manual /automatic operation switch, key switch for stroke adjustment in manual mode. Actual value output 0/4-20 mA for remote display.

Variable speed motors with integrated frequency converter (identity code specification V)

The following functions are integrated in the terminal box cover:

- Start/Stop switch
- Manual/external operation switch (0/4 - 20 mA)
- Potentiometer for speed control in manual mode
- Onn request externally controllable via PROFIBUS® DP

Variable speed motors with integrated frequency converter with IP 55 protection See page → 1-82

Speed controllers with frequency converter (identity code specification Z)

The speed controller (complete) comprises a frequency converter and a variable speed motor (see also identity code specification R). The frequency converter is accommodated in an IP 55 rated protective housing with integral control unit and main switch.

Externally controllable with 0/4 - 20 mA or 0 - 10 V corresponding to 0 - 50 (60) Hz output frequency.

Frequency Converters for Speed Control see page → 1-82





2.18 Plunger Metering Pump Makro TZ

Technical Data

Type TZKa	With 1500 rpm motor at 50 Hz				With 1800 rpm motor at 60 Hz			Suction lift m WC	Connection, suction/ discharge side G-DN	Shipping weight kg	Plunger Ø mm
	Delivery rate at max. back pressure		Max. stroke rate Strokes/ min	Delivery rate at max. back pressure		Max. stroke rate Strokes/ min					
	bar	l/h		ml/ stroke	psi		l/h/gph (US)				
320009	320	8.7	2.0	72	4,627	10/2.6	86	4.0	Rp 1/4**-8	50	12
320012	320	11.6	2.0	96	4,627	14/3.7	115	4.0	Rp 1/4**-8	50	12
320014	320	14.5	2.0	120	4,627	17/4.5	144	4.0	Rp 1/4**-8	50	12
320017	320	17.4	2.0	144	4,627	21/5.5	173	4.0	Rp 1/4**-8	50	12
320018	320	17.7	4.1	72	4,627	21/5.5	86	4.0	Rp 1/4**-8	50	17
320024	320	23.6	4.1	96	4,627	28/7.4	115	4.0	Rp 1/4**-8	54	17
320030	320	29.5	4.1	120	4,627	35/9.2	144	4.0	Rp 1/4**-8	54	17
313035	313	35.4	4.1	144	4,526	42/11.1	173	4.0	Rp 1/4**-8	54	17
192033	192	32.9	7.6	72	2,776	39/10.3	86	4.0	Rp 3/8**-10	55	23
192044	192	43.9	7.6	96	2,776	59/15.6	115	4.0	Rp 3/8**-10	55	23
192055	192	54.8	7.6	120	2,776	66/17.4	144	4.0	Rp 3/8**-10	55	23
168066	168	65.8	7.6	144	2,437	79/20.9	173	4.0	Rp 3/8**-10	55	23
113057	113	57.5	13.3	72	1,634	69/18.2	86	4.0	Rp 3/8**-10	56	30
113077	113	76.6	13.3	96	1,634	92/24.3	115	4.0	Rp 3/8**-10	56	30
113096	113	95.8	13.3	120	1,634	115/30.4	144	4.0	Rp 3/8**-10	56	30
096115	96	114.9	13.3	144	1,392	138/36.5	173	4.0	Rp 3/8**-10	56	30
063104	63	104.3	24.2	72	911	125/33.0	86	4.0	G 1 1/4-20	58	40
063139	63	139.0	24.2	96	911	167/44.1	115	4.0	G 1 1/4-20	58	40
063174	63	173.8	24.2	120	914	209/55.2	144	4.0	G 1 1/4-20	58	40
052208	52	208.5	24.2	144	754	250/66.0	173	4.0	G 1 1/4-20	58	40
040163	40	162.9	37.7	72	578	195/51.5	86	4.0	G 1 1/4-20	58	50
040217	40	217.2	37.7	96	578	261/68.9	115	4.0	G 1 1/4-20	58	50
040271	40	271.5	37.7	120	580	326/86.1	144	4.0	G 1 1/4-20	58	50
033326	33	325.8	37.7	144	479	391/103.3	173	4.0	G 1 1/4-20	58	50
028237	28	237.0	54.9	72	405	284/75.0	86	4.0	G 1 1/2-25	62	60
028316	28	315.9	54.9	96	405	379/100.1	115	4.0	G 1 1/2-25	62	60
027395	27	394.9	54.9	120	392	474/125.2	144	4.0	G 1 1/2-25	62	60
022474	22	473.9	54.9	144	319	569/150.3	173	4.0	G 1 1/2-25	62	60
020322	20	322.5	74.7	72	289	387/102.2	86	4.0	G 1 1/2-25	62	70
020430	20	430.0	74.7	96	289	516/136.3	115	4.0	G 1 1/2-25	62	70
020538	20	537.6	74.7	120	290	645/170.4	144	4.0	G 1 1/2-25	62	70
016645	16	645.1	74.7	144	232	774/204.5	173	4.0	G 1 1/2-25	62	70
014475	14	475.1	110.0	72	202	571/150.8	86	4.0	G 2 1/4-40	68	85
014634	14	634.1	110.0	96	202	761/201.0	115	4.0	G 2 1/4-40	68	85
013793	13	792.6	110.0	120	189	951/251.2	144	4.0	G 2 1/4-40	68	85
011951	11	951.1	110.0	144	160	1,141/301.4	173	4.0	G 2 1/4-40	68	85

Other gear reduction ratios are available upon request.

The permissible admission pressure on the suction side is approx. 50% of the max. permissible back pressure.

** The suction and discharge connectors Rp 1/4 and Rp 3/8 are inner threaded and fitted with double ball valves.

Materials in Contact With the Medium

Pump type	Hydraulic Ø mm	Dosing head connection	Suction/pressure seals	Ball seat	Valve balls	Plunger
SST	...12 S to 50 S	Stainless steel 1.4571/1.4404	1.4571/1.4404	SS/PTFE	Oxide ceramic	Stainless steel/ceramic
SST	...60 S to 70 S	Stainless steel 1.4571/1.4404	1.4581	PTFE/PTFE	Stainless steel 1.4404	Stainless steel/ceramic
SST	...85 S	Stainless steel 1.4571/1.4404	1.4581	PTFE/PTFE	1.4404 (plate) Hast. C (spring)	Stainless steel/ceramic

2.18 Plunger Metering Pump Makro TZ

2.18.2 Identity Code Ordering System TZKa

Plunger metering pump TZKa

TZKa		Drive type				
H	Main drive					
A	Add-on					
D	Double main drive					
B	Double add-on					
Type*						
320009	320030	113057	063174	028237	020538	
320012	313035	113077	052208	028316	016645	
320014	192033	113096	040163	027395	014475	
320017	192044	096115	040217	022474	014634	
320018	192055	063104	040271	020322	013793	
320024	168066	063139	033326	020430	011951	
Liquid end material						
SS	Stainless steel					
Sealing material						
T	PTFE					
Displacement body						
S	Stainless steel plunger, chromium dioxide-coated					
Liquid end version						
0	No valve springs					
1	With valve springs					
Hydraulic connection						
0	Standard connection					
4	SS union nut and insert					
Version						
0	With ProMinent® logo, no frame					
2	Without ProMinent® logo, no frame					
A	With ProMinent® logo, with frame, simplex					
B	With ProMinent® logo, with frame, duplex					
C	With ProMinent® logo, with frame, triplex					
M	Modified					
Electrical power supply						
S	3 ph. 230/400 V 50/60 Hz (WBS)					
R	Variable speed motor 4-pole 230/400 V					
V (0)	Variable speed motor with integr. frequency converter					
Z	1 ph, variable speed control set 1 ph, 230 V, 50/60 Hz					
P	3 ph. 230/400 V 60 Hz (Exe, Exd)					
L	3 ph. 230/400 V 50 Hz (Exe, Exd)					
V (2)	With integrated frequency converter (Exd)					
4	No motor, with 56 C flange					
7	No motor, with 120/80 flange					
8	No motor, with 160/90 flange					
0	Without motor, externally mounted drive					
Enclosure rating						
0	IP 55 (Standard) ISO class F					
1	Exe version ATEX-T3					
2	Exd version ATEX-T4					
A	ATEX power end					
Stroke sensor						
0	No stroke sensor					
1	With stroke sensor (Namur)					
Stroke length adjustment						
0	Stroke length adjustment, man.					
1	230 V stroke adjustment motor					
2	115 V stroke adjustment motor					
3	230 V 0-20 mA stroke controller					
4	230 V 4-20 mA stroke controller					
5	115 V 0-20 mA stroke controller					
6	115 V 4-20 mA stroke controller					
Application						
0	Standard					

* Digits 1 - 3=back pressure [bar]; digits 4 - 6=feed rate [l/h]





2.18 Plunger Metering Pump Makro TZ

Motor Data

Identity code specification		Power supply			Remarks
S	3 ph, IP 55	220-240 V/380-420 V 250-280 V/440-480 V	50 Hz 60 Hz	1.5 kW	
R	3 ph, IP 55	230 V/400 V	50/60 Hz	2.2 kW	With PTC, speed adjustment range 1:20 with external fan 1 ph 230 V; 50/60Hz
V0	3 ph, IP 55	400 V ±10%	50/60 Hz	2.2 kW	Variable speed motor with integrated frequency converter
L1	3 ph, II2GEEExII T3	220-240 V/380-420 V	50 Hz	1.5 kW	
L2	3 ph, II2GEEExdII CT4	220-240 V/380-420 V	50 Hz	1.5 kW	With PTC, speed control range 1:5
P1	3 ph, II2GEEExII T3	250-280 V/440-480 V	60 Hz	1.5 kW	
P2	3 ph, II2GEEExdII CT4	250-280 V/440-480 V	60 Hz	1.5 kW	With PTC, speed control range 1:5
V2	3 ph, II2GEEExdII CT4	400 V ±10%	50/60 Hz	2.2 kW	Ex-variable speed motor with integrated frequency converter

Motor data sheets can be requested for more information. Motors for Sigma basic pumps, special motors or special motor flanges are available on request.

The motors are designed in compliance with the Ecodesign Directive 2009/125/EC.

Information for use in areas at risk from explosion

Only use pumps with the appropriate labelling in line with the ATEX Directive 94/9/EC in premises at risk from explosion. Ensure that the explosion group, category and degree of protection specified on the label corresponds to or is better than the conditions prevalent in the intended field of application.

2.18.3

Spare Parts Kits

Spare Parts Kits for Plunger Metering Pump Makro TZ

Comprising:

Valve balls
Valve plate with spring
Ball seat discs
PTFE/graphite plunger packing rings
Plunger guides
Flat seals/O rings

	Order no.
Spare parts kit for Makro TZ FK 12/20 S DN 8	1019106
Spare parts kit for Makro TZ FK 17/20 S DN 8	1019107
Spare parts kit for Makro TZ FK 23/20 S DN 10	1019108
Spare parts kit for Makro TZ FK 30/20 S DN 10	1019109
Spare parts kit for Makro TZ FK 40/20 S DN 20	1019110
Spare parts kit for Makro TZ FK 50/20 S DN 20	1019111
Spare parts kit for Makro TZ FK 60/20 S DN 25	1019112
Spare parts kit for Makro TZ FK 70/20 S DN 25	1019113
Spare parts kit for Makro TZ FK 85/20 S DN 40	1019124

2.19 Plunger Metering Pump Makro/ 5

2.19.1 Plunger Metering Pump Makro/ 5

Powerful, built to last with a plunger

Capacity range of single pump: 38 – 6,014 l/h, 320 – 6 bar

The plunger metering pump Makro/ 5 can virtually be used throughout the low-pressure range and its modular construction enables it to be outstandingly adapted to the performance requirements of the respective application.

The plunger metering pump Makro/ 5 (M5ka) together with the Makro/ 5 hydraulic diaphragm and plunger metering pumps form a range of drive mechanisms with stroke lengths of 20 and/or 50 mm. This covers the capacity range from 38 to 6,108 l/h at 320 – 4 bar. A wide range of drive versions is available, including some for use in Exe and Exde areas with ATEX certification.

Your benefits

Process reliability:

- Metering reproducibility is better than $\pm 0.5\%$ within the 10 – 100% stroke length range under defined conditions and with correct installation

Excellent flexibility:

- The modular construction with single and double head versions permits a wide range of applications, with the double head designs being operated in push-pull mode
- It is possible to combine up to 4 metering units, even with different pump capacities, in multiple pump systems
- 5 different gear ratios are available
- Customised designs are available on request

Technical Details

- Stroke length: 0-50 mm, Rod force: 10,000 N
- Stroke length adjustment range: 0 – 100%
- Stroke length adjustment: manually by means of a manual adjustment wheel and scaled display in 0.5% increments (optionally with electric control drive)
- Metering reproducibility is better than $\pm 0.5\%$ within the 10 – 100% stroke length range under defined conditions and with correct installation. Observe the information in the operating instructions
- High-performance ceramic-coated stainless steel plunger
- Wetted materials: Stainless steel 1.4571, special materials are available on request
- A wide range of power end versions is available: three-phase standard motors, motors for use in Exe and Exde areas and different flange designs for use in customer-specific motors
- Degree of protection: IP 55
- Salt water-resistant, acrylic resin-coated cast aluminium housing
- Provide suitable overload protection in all plunger metering pumps during installation for safety reasons

Field of application

- Volume-proportional metering of chemicals/additives in water treatment
- Metering of reactants and catalysts in the chemical industry
- Level-dependent metering of additives in industrial production engineering

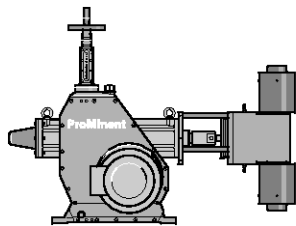

pk_2_075
Makro/ 5 M5Ka

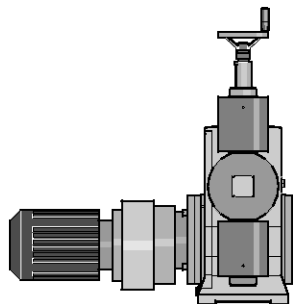

pk_2_076
Makro/ 5 M5Ka

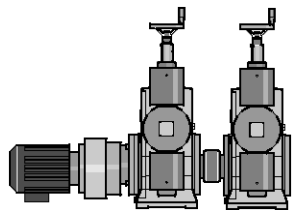

pk_2_077
Makro/ 5 M5Ka externally mounted pump

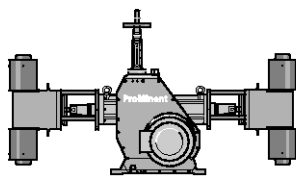

pk_2_078
Makro/ 5 double head pump





2.19 Plunger Metering Pump Makro/ 5

Makro/ 5 Pump Control

Stroke length variable speed drive Makro/ 5

Variable speed drive consisting of actuator with motor actuator and integrated microprocessor controller for stroke length adjustment via a standard signal. Actuating time approx. 100 sec. for 100% stroke length, equipped with 2 limit switches for min./max. position, IP rating: IP 52. Electrical connection 230 V ($\pm 10\%$), 50/60 Hz, approx. 40 W, mech. stroke position indicator present at drive Makro/ 5.

Special voltage/higher IP ratings/Ex protection on request.

Includes:

Standard current input 0/4-20 mA (corresponds to stroke length 0-100%); internal switch for manual/automatic operation, key switch for stroke adjustment in manual operation mode. Actual value output 0/4-20 mA for remote display.

Frequency converter for speed control in metal housing, IP rating 54

Frequency converter installed in protective housing IP 54 with integrated control unit and main switch suitable for the motor output stated in the following.

Externally controllable with 0/4-20 mA or 0-10V corresponding to 0-50 (60) Hz output frequency.

Integrated control unit with numerous functions, such as toggling external/internal control. With internal control, frequency setting is via arrow keys, error message on multi lingual display etc.

Including evaluator for temperature monitoring of the motor (thermistor protection).

Stroke sensor with namur signal

Mounted on the crank drive of the Makro/5 gearbox. For precise detection of each metering stroke, consisting of actuating cams and inductive proximity switch, switching signal according to Namur. Combined with electronic preselection counters suitable for batch metering or proportional metering in connection with the proportional control.

Retrofitting is only possible on factory premises.

Approved for ex-proof operation with IP rating EEx ia II C T6.

2.19 Plunger Metering Pump Makro/ 5

Technical Data

Type M5Ka	With 1500 rpm motor at 50 Hz				With 1800 rpm motor at 60 Hz				Suction lift m WC	Connection, suction/ discharge side G-DN	Shipping weight kg	Plunger Ø mm
	Delivery rate at max. back pressure		Max. stroke rate		Delivery rate at max. back pressure		Max. stroke rate					
	bar	l/h	ml/ stroke	Strokes/ min	psi	l/h	gph (US)	Strokes/ min				
3200038	320	38	11	60	4,640	44	12	71	3.0	Rp 1/4-8	300	17
3200048	320	48	11	75	4,640	56	15	89	3.0	Rp 1/4-8	300	17
3200066	320	66	11	103	4,640	78	21	123	3.0	Rp 1/4-8	300	17
3200085	320	85	11	133	4,640	101	27	159	3.0	Rp 3/8-10	300	17
3200100	320	100	11	156	-	-	-	-	3.0	Rp 3/8-10	300	17
2400070	240	70	21	60	3,480	82	22	71	3.0	Rp 3/8-10	300	23
2400088	240	88	21	75	3,480	104	27	89	3.0	Rp 3/8-10	300	23
2400121	240	121	21	103	3,480	144	38	123	3.0	Rp 3/8-10	300	23
2160157	216	157	21	133	3,132	187	49	159	3.0	Rp 3/8-10	300	23
1700184	170	184	21	156	-	-	-	-	3.0	G 1-15	300	23
1400120	140	120	35	60	2,030	142	38	71	3.0	G 1-15	302	30
1400151	140	151	35	75	2,030	179	47	89	3.0	G 1-15	302	30
1400207	140	207	35	103	2,030	247	65	123	3.0	G 1-15	302	30
1270267	127	267	35	133	1,842	319	84	159	3.0	G 1 1/4-20	302	30
1000314	100	314	35	156	-	-	-	-	3.0	G 1 1/4-20	302	30
0800214	80	214	63	60	1,160	253	67	71	3.0	G 1 1/4-20	303	40
0800268	80	268	63	75	1,160	318	84	89	3.0	G 1 1/4-20	303	40
0800368	80	368	63	103	1,160	439	116	123	3.0	G 1 1/4-20	303	40
0700476	70	476	63	133	1,015	569	150	159	3.0	G 1 1/2-25	303	40
0560558	56	558	63	156	-	-	-	-	3.0	G 1 1/2-25	303	40
0500335	50	335	98	60	725	396	105	71	3.0	G 1 1/2-25	303	50
0500419	50	419	98	75	725	497	131	89	3.0	G 1 1/2-25	303	50
0500576	50	576	98	103	725	687	181	123	3.0	G 1 1/2-25	303	50
0450744	45	744	98	133	653	889	235	159	3.0	G 2-32	303	50
0350872	35	872	98	156	-	-	-	-	3.0	G 2-32	303	50
0350483	35	483	141	60	508	571	151	71	3.0	G 1 1/2-25	311	60
0350604	35	604	141	75	508	716	189	89	3.0	G 1 1/2-25	311	60
0350829	35	829	141	103	508	989	261	123	3.0	G 2-32	311	60
0301071	30	1,071	141	133	435	1,280	338	159	3.0	G 2-32	311	60
0251257	25	1,257	141	156	-	-	-	-	3.0	G 2-32	311	60
0250658	25	658	192	60	363	778	206	71	3.0	G 2-32	311	70
0250822	25	822	192	75	363	975	258	89	3.0	G 2-32	311	70
0251129	25	1,129	192	103	363	1,348	356	123	3.0	G 2-32	311	70
0231458	23	1,458	192	133	334	1,743	460	159	3.0	G 2 1/4-40	311	70
0181710	18	1,710	192	156	-	-	-	-	3.0	G 2 1/4-40	311	70
0160970	16	970	284	60	232	1,147	303	71	3.0	G 2 1/4-40	317	85
0161212	16	1,212	284	75	232	1,438	380	89	3.0	G 2 1/4-40	317	85
0161665	16	1,665	284	103	232	1,988	525	123	3.0	G 2 1/4-40	317	85
0162150	16	2,150	284	133	232	2,570	679	159	3.0	G 2 3/4-50	317	85
0162522	16	2,522	284	156	-	-	-	-	3.0	G 2 3/4-50	317	85
0121343	12	1,343	393	60	174	1,589	420	71	3.0	G 2 3/4-50	331	100
0121678	12	1,678	393	75	174	1,991	526	89	3.0	G 2 3/4-50	331	100
0122305	12	2,305	393	103	174	2,752	727	123	3.0	G 2 3/4-50	331	100
0122977	12	2,977	393	133	174	3,558	940	159	3.0	G 2 3/4-50	331	100
0103491	10	3,491	393	156	-	-	-	-	3.0	G 2 3/4-50	331	100
0062269	6	2,269	664	60	87	2,684	709	71	3.0	G 2 1/2-65	350	130
0062837	6	2,837	664	75	87	3,366	889	89	3.0	G 2 1/2-65	350	130
0063896	6	3,896	664	103	87	4,652	1,229	123	3.0	G 2 1/2-65	350	130
0065031	6	5,031	664	133	87	6,014	1,589	159	3.0	G 2 1/2-65	350	130
0066000	6	6,000	664	156	-	-	-	-	3.0	G 2 1/2-65	350	130





2.19 Plunger Metering Pump Makro/ 5

2.19.2 Identity Code Ordering System for M5Ka

Plunger metering pump Makro/ 5

M5Ka	Drive type				
H	Main drive				
A	Add-on power end				
D	Double main drive				
B	Double add-on power end				
Type*					
3200038	1400120	0500335	0250658	0121343	
3200048	1400151	0500419	0250822	0121678	
3200066	1400207	0500576	0251129	0122305	
3200085	1270267	0450744	0231458	0122977	
3200100	1000314	0350872	0181710	0103491	
2400070	0800214	0350483	0160970	0062269	
2400088	0800268	0350604	0161212	0062837	
2400121	0800368	0350829	0161665	0063896	
2160157	0700476	0301071	0162150	0065031	
1700184	0560558	0251257	0162522	0066000	
Liquid end material					
SS	Stainless steel				
Sealing material*					
T	PTFE				
Displacement body					
S	Stainless steel plunger, chromium dioxide-coated				
Liquid end version					
0	No valve springs				
1	With valve springs				
Hydraulic connection					
0	Standard connection				
4	SS union nut and insert				
Version					
0	With ProMinent® logo, no frame				
2	No ProMinent® logo, no frame				
A	With ProMinent® logo, with frame, simplex				
B	With ProMinent® logo, with frame, duplex				
C	With ProMinent® logo, with frame, triplex				
D	With ProMinent® logo, with frame, quadruplex				
M	Modified				
Electrical power supply					
S	3 ph. 230/400 V 50/60 Hz (WBS)				
R	Variable speed motor 4-pole 230/400 V				
V (0)	Motor with integrated frequency converter				
P	3 ph. 230/400 V 60 Hz (Exe, Exd)				
L	3 ph. 230/400 V 50 Hz (Exe, Exd)				
V (2)	Motor with integrated frequency converter (Exd)				
5	No motor, with IEC 100 gearbox				
6	No motor, with IEC 112 gearbox				
0	No motor, no gearbox				
Enclosure rating					
0	IP 55 (Standard) ISO class F				
1	Exe version ATEX-T3				
2	Exd version ATEX-T4				
A	ATEX power end				
Stroke sensor					
0	No stroke sensor				
1	With stroke sensor (Nampur)				
Stroke length adjustment					
0	Stroke length adjustment, man.				
3	230 V 0-20 mA stroke controller				
4	230 V 4-20 mA stroke controller				
5	115 V 0-20 mA stroke controller				
6	115 V 4-20 mA stroke controller				
G	Control drive 230 V 0-20 mA Exde				
H	Control drive 230 V 4-20 mA Exde				
Application					
0	Standard				
3	Temperature up to -20 °C				

* Digits 1 - 3=back pressure [bar]; digits 4 - 7=feed rate [l/h]

2.19 Plunger Metering Pump Makro/ 5

Materials in Contact With the Medium

	Liquid end	Suction/pressure connector	Valve seat/ seals	Valve balls	Plunger
Makro 5/50 HK ...DN 8-DN 10	Stainless steel 1.4571/1.4404	1.4571/1.4404	SS/PTFE	Oxide ceramics	Stainless steel/ceramic
Makro 5/50 HK ...DN 15-DN 25	Stainless steel 1.4571/1.4404	1.4581	PTFE/PTFE	Stainless steel 1.4401	Stainless steel/ceramic
Makro 5/50 HK ...DN 32-DN 65	Stainless steel 1.4571/1.4404	1.4581/1.4404	PTFE/PTFE	Stainless steel 1.4404 (plate/spring)	Stainless steel/ceramic

The permissible priming pressure on the suction side is approx. 50% of the max. permissible back pressure.

Motor Data

Identity code specification	Power supply	Remarks
S	3 ph, IP 55 220-240 V/380-420 V 250-280 V/440-480 V	50 Hz 3 kW 60 Hz
R	3 ph, IP 55 230 V/400 V	50/60 Hz 3 kW With PTC, speed control range 1:5
V0	3 ph, IP 55 400 V ±10%	50/60 Hz 3 kW Variable speed motor with integrated frequency converter
L1	3 ph, II2GEEexIIIT3 220-240 V/380-420 V	50 Hz 3.6 kW
L2	3 ph, II2GEEexIIICT4 220-240 V/380-420 V	50 Hz 4 kW With PTC, speed control range 1:5
P1	3 ph, II2GEEexIIIT3 250-280 V/440-480 V	60 Hz 3.6 kW
P2	3 ph, II2GEEexIIICT4 250-280 V/440-480 V	60 Hz 4 kW With PTC, speed control range 1:5
V2	3 ph, II2GEEexIIICT4 400 V ±10%	50/60 Hz 4 kW Ex-variable speed motor with integrated frequency converter

Motor data sheets can be requested for more information. Motors for Sigma basic pumps, special motors or special motor flanges are available on request.

The motors are designed in compliance with the Ecodesign Directive 2009/125/EC.

Information for use in areas at risk from explosion

Only use pumps with the appropriate labelling in line with the ATEX Directive 94/9/EC in premises at risk from explosion. Ensure that the explosion group, category and degree of protection specified on the label corresponds to or is better than the conditions prevalent in the intended field of application.





2.19 Plunger Metering Pump Makro/ 5

2.19.3

Spare Parts Kits

Spare parts kit for Makro/ 5, consisting of:

- Valve balls
- Valve plate with spring
- Ball seat discs
- Plunger packings made from PTFE/graphite
- Piston guide bands
- Flat seals / O-rings

	Order no.
Spare parts kit for Makro/ 5 FK 17/50 S DN 8	1005899
Spare parts kit for Makro/ 5 FK 17/50 S DN 10	1005536
Spare parts kit for Makro/ 5 FK 23/50 S DN 10	1005004
Spare parts kit for Makro/ 5 FK 23/50 S DN 15	1005900
Spare parts kit for Makro/ 5 FK 30/50 S DN 15	1005901
Spare parts kit for Makro/ 5 FK 30/50 S DN 20	1005537
Spare parts kit for Makro/ 5 FK 40/50 S DN 20	1005902
Spare parts kit for Makro/ 5 FK 40/50 S DN 25	1005538
Spare parts kit for Makro/ 5 FK 50/50 S DN 25	1005539
Spare parts kit for Makro/ 5 FK 60/50 S DN 25	1005903
Spare parts kit for Makro/ 5 FK 60/50 S DN 32	1005540
Spare parts kit for Makro/ 5 FK 70/50 S DN 32	1005541
Spare parts kit for Makro/ 5 FK 70/50 S DN 40	1005904
Spare parts kit for Makro/ 5 FK 85/50 S DN 40	1005542
Spare parts kit for Makro/ 5 FK 85/50 S DN 50	1005905
Spare parts kit for Makro/ 5 FK 100/50 S DN 50	1005543
Spare parts kit for Makro/ 5 FK 130/50 S DN 65	1005544

2.20 Plunger Metering Pump Orlita® Evolution 1

2.20.1 Plunger Metering Pump Orlita® Evolution 1

Simple and flexible.

Capacity range of single pump: 5 – 511 l/h; 293 – 8 bar

The high-performance plunger metering pump ORLITA® Evolution 1 enables precise pump capacities even at maximum pressure and temperatures of up to + 200 °C. The ORLITA® Evolution pump has a modular construction and thus versatile uses.

The Orlita® Evolution plunger metering pumps EP1a and EP2a form an integrated product range with stroke lengths of 15 mm. This covers a capacity range from 5 to 511 l/h at 293 – 8 bar. A wide range of drive versions is available, including some for use in Zone 1 or Zone 2 areas at risk from explosion with ATEX certification. The Orlita® Evolution product range is designed to comply with API 675.

Your benefits

Flexible adaptation to the process:

- Precise capacity even at maximum pressure
- Metering reproducibility is better than ± 0.5 % within the 10 - 100 % stroke length range under defined conditions and with correct installation.
- Excellent hydraulic efficiency

Excellent flexibility:

- The modular and compact construction with single and multiple pump versions permits a wide range of applications. In multiple pump systems up to 5 metering units can be combined, including units with different pump capacities
- 7 gear ratios are available
- Power end configuration ideal for installation in any position (vertical or horizontal)
- Customised designs are available on request

Technical Details

- Stroke length: 0 - 15 mm, Rod force: 2,300 N
- Stroke length adjustment: 0 – 100 %
- Stroke length adjustment range: 0 – 100 % in operation and idle
- The plunger packing can be tightened by the tensioning screw on the front even during operation
- Metering reproducibility is better than ± 0.5 % within the 10 – 100 % stroke length range under defined conditions and with correct installation
- Wetted materials: Stainless steel, special designs are available on request
- A wide range of power end versions is available: Three-phase standard motors, motors for use in Exe and Exde areas and different flange designs for use in customer-specific motors
- Degree of protection: IP 55
- Temperature range - 40 °C to + 200 °C
- Design in compliance with API 675 among others

Field of application

- Oil/ gas production (onshore/offshore)
- Refineries
- Chemical / petrochemical industry
- Pharmaceuticals & cosmetics
- Packaging industry (bottling pumps)
- Maximum temperature applications of up to + 200 °C

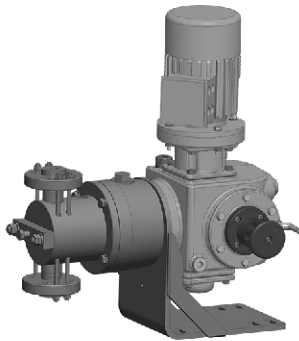

P_PZ_0019_SW1
Plunger Metering Pump Orlita® Evolution

NEW





2.20 Plunger Metering Pump Orlita® Evolution 1

Technical data for EP1a single pump 50 Hz SST

Plunger Ø	Stroke volume	Theoretical pump capacity in l/h at strokes/min (50 Hz)							Max. pressure	Efficiency at 100% pressure	Efficiency at 50% pressure	Standard type of valve
		73 [2] l/h	97 [3] l/h	116 [4] l/h	145 [5] l/h	165 [6] l/h	181 [7] l/h	201 [8] l/h				
mm	ml/ stroke								bar			
10	1.18	5.2	6.9	8.2	10.2	11.7	12.8	14.2	293	0.89	0.93	DN 6
12	1.70	7.4	9.9	11.8	14.8	16.8	18.4	20.5	203	0.89	0.93	DN 6
14	2.31	10.1	13.4	16.1	20.1	22.9	25.1	27.8	149	0.89	0.93	DN 6
17	3.40	14.9	19.8	23.7	29.6	33.7	37.0	41.1	101	0.90	0.90	DN 10
21	5.20	22.8	30.3	36.2	45.2	51.4	56.4	62.7	66	0.93	0.95	DN 10
25	7.36	32.2	42.9	51.2	64.1	72.9	80.0	88.8	47	0.93	0.95	DN 10
29	9.91	43.4	57.7	69.0	86.2	98.1	107.6	119.5	35	0.96	0.98	DN 10
32	12.06	52.8	70.2	84.0	105.0	119.4	131.0	145.4	29	0.96	0.98	DN 16
38	17.01	74.5	99.0	118.4	148.0	168.4	184.7	205.2	20	0.96	0.98	DN 16
44	22.81	99.9	132.7	158.7	198.4	225.8	247.7	275.1	15	0.96	0.98	DN 16
50	29.45	129.0	171.4	205.0	256.2	291.6	319.9	355.2	12	0.96	0.98	DN 16
58	39.63	173.6	230.7	275.8	344.8	392.3	430.4	478.0	9	0.96	0.98	DN 16
60	42.41	185.8	246.8	295.2	369.0	419.9	460.6	511.5	8	0.96	0.98	DN 16

Technical data for EP1a single pump 60 Hz SST

Plunger Ø	Stroke volume	Theoretical pump capacity in l/h at strokes/min (60 Hz)					Max. pressure	Efficiency at 100% pressure	Efficiency at 50% pressure	Standard type of valve
		88 [2] l/h	117 [3] l/h	140 [4] l/h	175 [5] l/h	199 [6] l/h				
mm	ml/ stroke						bar			
10	1.18	6.2	8.3	9.9	12.4	14.1	293	0.89	0.93	DN 6
12	1.70	9.0	11.9	14.3	17.8	20.3	203	0.89	0.93	DN 6
14	2.31	12.2	16.2	19.4	24.2	27.6	149	0.89	0.93	DN 6
17	3.40	18.0	23.9	28.6	35.7	40.7	101	0.90	0.90	DN 10
21	5.20	27.4	36.5	43.6	54.6	62.0	66	0.93	0.95	DN 10
25	7.36	38.9	51.7	61.9	77.3	87.9	47	0.93	0.95	DN 10
29	9.91	52.3	69.6	83.2	104.0	118.3	35	0.96	0.98	DN 10
32	12.06	63.7	84.7	101.3	126.7	144.0	29	0.96	0.98	DN 16
38	17.01	89.8	119.4	142.9	178.6	203.1	20	0.96	0.98	DN 16
44	22.81	120.4	160.1	191.6	239.5	272.3	15	0.96	0.98	DN 16
50	29.45	155.5	206.8	247.4	309.3	351.7	12	0.96	0.98	DN 16
58	39.63	209.3	278.2	332.9	416.1	473.2	9	0.96	0.98	DN 16
60	42.41	223.9	297.7	356.3	445.3	506.4	8	0.96	0.98	DN 16

Note:

Abridged presentation of our complete product range. Other piston diameters (8-60 mm) on request.

Materials in Contact With the Medium

Ball valve DN 6 – DN 10

	Suction/ pressure connector	Valve/ head seal	Valve ball	Valve seat	Valve housing	Clamp ring
DN 6 (double ball)	Stainless steel 1.4404	Stainless steel 1.4404	SiN ceramic	Stainless steel 1.4404	Stainless steel 1.4404	Hastelloy C4
DN 10 (single ball)	Stainless steel 1.4404	Stainless steel 1.4404	Al ₂ O ₃ ceramic	Stainless steel 1.4404	Stainless steel 1.4404	Hastelloy C4

Plate valve DN 16 – DN 20

	Suction/ pressure connector	Valve/ head seal	Valve plate	Valve seat	Valve housing
DN 16/DN 20	Stainless steel 1.4404	Stainless steel 1.4571	Stainless steel 1.4462	Stainless steel 1.4404	Stainless steel 1.4404

Further material versions and details available on request.

2.21 Plunger Metering Pump Orlita® Evolution 2

2.21.1

Plunger Metering Pump Orlita® Evolution 2

Simple and flexible.

Capacity range of single pump: 5 – 511 l/h; 520 – 19 bar

The high-performance plunger metering pump ORLITA® Evolution 1 enables precise pump capacities even at maximum pressure and temperatures of up to + 200 °C. The ORLITA® Evolution pump has a modular construction and thus versatile uses.

The Orlita® Evolution plunger metering pumps EP1a and EP2a form an integrated product range with stroke lengths of 15 mm. This covers a capacity range from 5 to 511 l/h at 520 – 19 bar. A wide range of drive versions is available, including some for use in Zone 1 or Zone 2 areas at risk from explosion with ATEX certification. The Orlita® Evolution product range is designed to comply with API 675.

Your benefits

Flexible adaptation to the process:

- Precise capacity even at maximum pressure
- Metering reproducibility is better than $\pm 0.5\%$ within the 10 - 100 % stroke length range under defined conditions and with correct installation.
- Excellent hydraulic efficiency

Excellent flexibility:

- The modular and compact construction with single and multiple pump versions permits a wide range of applications. In multiple pump systems up to 5 metering units can be combined, including units with different pump capacities
- 7 gear ratios are available
- Power end configuration ideal for installation in any position (vertical or horizontal)
- Customised designs are available on request

Technical Details

- Stroke length 0 – 15 mm, rod force: 5,400 N
- Stroke length adjustment range: 0 – 100 % in operation and idle
- The plunger packing can be tightened by the tensioning screw on the front even during operation
- Metering reproducibility is better than $\pm 0.5\%$ within the 10 – 100 % stroke length range under defined conditions and with correct installation
- Wetted materials: Stainless steel, special designs are available on request
- A wide range of power end versions is available: Three-phase standard motors, motors for use in Exe and Exde areas and different flange designs for use in customer-specific motors
- Degree of protection: IP 55
- Temperature range - 40 °C to + 200 °C
- Design in compliance with API 675 among others

Field of application

- Oil/ gas production (onshore/offshore)
- Refineries
- Chemical / petrochemical industry
- Pharmaceuticals & cosmetics
- Packaging industry (bottling pumps)
- Maximum temperature applications of up to + 200 °C

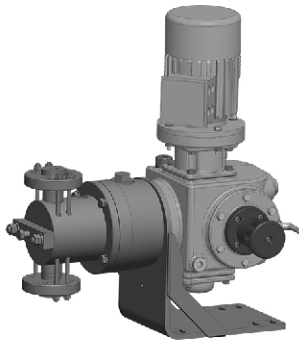

P_PZ_0019_SW1
Plunger Metering Pump Orlita® Evolution

NEW





2.21 Plunger Metering Pump Orlita® Evolution 2

Technical data for EP2a single pump 50 Hz SST

Plunger Ø	Stroke volume	Theoretical pump capacity in l/h at strokes/min (50 Hz)							Max. pressure	Efficiency at 100% pressure	Efficiency at 50% pressure	Standard type of valve
		73 [2]	97 [3]	116 [4]	145 [5]	165 [6]	181 [7]	201 [8]				
mm	ml/stroke	l/h	l/h	l/h	l/h	l/h	l/h	l/h	bar			
10	1.18	5.2	6.9	8.2	10.2	11.7	12.8	14.2	520	0.89	0.93	DN 6
12	1.70	7.4	9.9	11.8	14.8	16.8	18.4	20.5	477	0.89	0.93	DN 6
14	2.31	10.1	13.4	16.1	20.1	22.9	25.1	27.8	351	0.89	0.93	DN 6
17	3.40	14.9	19.8	23.7	29.6	33.7	37.0	41.1	238	0.91	0.94	DN 10
21	5.20	22.8	30.2	36.2	45.2	51.4	56.4	62.7	156	0.93	0.95	DN 10
25	7.36	32.3	42.9	51.2	64.1	72.9	80.0	88.8	110	0.93	0.95	DN 10
29	9.91	43.4	57.7	69.0	86.2	98.1	107.6	119.5	82	0.96	0.98	DN 10
32	12.06	52.8	70.2	84.0	105.0	119.4	131.0	145.5	67	0.96	0.98	DN 16
38	17.01	74.5	99.0	118.4	148.0	168.4	184.7	205.2	48	0.96	0.98	DN 16
44	22.81	99.9	132.7	158.7	198.4	225.8	247.7	275.1	36	0.96	0.98	DN 16
50	29.45	129.0	171.4	205.0	256.2	291.6	319.9	355.2	28	0.96	0.98	DN 16
58	39.63	173.6	230.7	275.8	344.8	392.3	430.4	478.0	20	0.96	0.98	DN 16
60	42.41	185.8	246.8	295.2	369.0	419.9	460.6	511.5	19	0.96	0.98	DN 16

Technical data for EP2a single pump 60 Hz SST

Plunger Ø	Stroke volume	Theoretical pump capacity in l/h at strokes/min (60 Hz)					Max. pressure	Efficiency at 100% pressure	Efficiency at 50% pressure	Standard type of valve
		88 [2]	117 [3]	140 [4]	175 [5]	199 [6]				
mm	ml/stroke	l/h	l/h	l/h	l/h	l/h	bar			
10	1.18	6.2	8.3	9.9	12.4	14.1	520	0.89	0.93	DN 6
12	1.70	9.0	11.9	14.3	17.8	20.3	477	0.89	0.93	DN 6
14	2.31	12.2	16.2	19.4	24.2	27.6	351	0.89	0.93	DN 6
17	3.40	18.0	23.9	28.6	35.7	40.7	238	0.89	0.93	DN 10
21	5.20	27.4	36.5	43.6	54.6	62.0	156	0.93	0.95	DN 10
25	7.36	38.9	51.7	61.9	77.3	87.9	110	0.93	0.95	DN 10
29	9.91	52.3	69.6	83.2	104.0	118.3	82	0.96	0.98	DN 10
32	12.06	63.7	84.7	101.3	126.7	144.0	67	0.96	0.98	DN 16
38	17.01	89.8	119.4	142.9	178.6	203.1	48	0.96	0.98	DN 16
44	22.81	120.4	160.1	191.6	239.5	272.3	36	0.96	0.98	DN 16
50	29.45	155.5	206.8	247.4	309.3	351.7	28	0.96	0.98	DN 16
58	39.63	209.3	278.2	332.9	416.1	473.2	20	0.96	0.98	DN 16
60	42.41	223.9	297.7	356.3	445.3	506.4	19	0.96	0.98	DN 16

Note:

Abridged presentation of our complete product range. Other types on request. Plunger diameter 11 - 80 mm.

Materials in Contact With the Medium

Ball valve DN 6 – DN 10

	Suction/ pressure connector	Valve/ head seal	Valve ball	Valve seat	Valve housing	Clamp ring
DN 6 (double ball)	Stainless steel 1.4404	Stainless steel 1.4404	SiN ceramic	Stainless steel 1.4404	Stainless steel 1.4404	Hastelloy C4
DN 10 (single ball)	Stainless steel 1.4404	Stainless steel 1.4404	Al ₂ O ₃ ceramic	Stainless steel 1.4404	Stainless steel 1.4404	Hastelloy C4

Plate valve DN 16

	Suction/ pressure connector	Valve/ head seal	Valve plate	Valve seat	Valve housing
DN 16	Stainless steel 1.4404	Stainless steel 1.4571	Stainless steel 1.4462	Stainless steel 1.4404	Stainless steel 1.4404

Further material versions and details available on request.

2.22 Plunger Metering Pump Orlita® PS

2.22.1 Plunger Metering Pump Orlita® PS

Orlita® PS - simple, robust and reliable.

Capacity range of single pump: 0 – 37,000 l/h, 400 – 4 bar

The high-performance plunger metering pump ORLITA® PS enables precise pump capacities even at maximum pressure and temperatures of up to +400 °C. The ORLITA® PS pump has a modular construction and thus versatile uses.

ORLITA® PS plunger metering pumps (PS 18 to PS 1400) with a stroke length of 15 to 60 mm provide a capacity ranging from 0 to 37,000 l/h at 400 – 4 bar. A wide range of drive versions is available, including some for use in Exe and Exde areas with ATEX certification. The Orlita® PS product range is designed to comply with API 675. Its modular construction permits the free combination of drives, power ends and dosing heads, producing a pump for a range of different feed rates and media operating at different working pressures.

Your benefits

Flexible adaptation to the process:

- Precise capacity even at maximum pressure
- Metering reproducibility is better than $\pm 0.5\%$ within the 10-100% stroke length range under defined conditions and with correct installation.
- Cone valves for use as suction and/or discharge valves with minimal wear, good self-cleaning and low pressure loss (NPSHR)
- Excellent hydraulic efficiency

Excellent flexibility:

- The modular construction ensures a wide range of uses
- It is possible to combine up to 6 metering units, even with different pump capacities, in multiple pump systems
- 6 different gear ratios are available
- Power end configuration ideal for installation in any position (vertical or horizontal)
- Customised designs are available on request

Technical Details

- PS 18 – Stroke length: 0-15 mm, Rod force: 1,750 N
- PS 35 – Stroke length: 0-20 mm, Rod force: 3,500 N
- PS 80 – Stroke length: 0-20 mm, Rod force: 14,000 N
- PS 180 – Stroke length: 0-40 mm, Rod force: 18,000 N
- PS 600 – Stroke length: 0-40 mm, Rod force: 40,000 N
- PS 1400 – Stroke length: 0-60 mm, Rod force: 60,000 N
- Stroke length adjustment range: 0 – 100% in operation and idle
- The plunger packing can be tightened by the tensioning screw on the front even during operation
- Metering reproducibility is better than $\pm 0.5\%$ within the 10 – 100% stroke length range under defined conditions and with correct installation
- Wetted materials: Stainless steel, special designs are available on request
- A wide range of power end versions is available: Three-phase standard motors, motors for use in Exe and Exde areas and different flange designs for use in customer-specific motors
- Degree of protection: IP 55
- Temperature range - 40 °C to + 400 °C
- Design in compliance with API 675 among others

Field of application

- Oil/ gas production (onshore/offshore)
- Refineries
- Chemical/Petrochemical industry
- Pharmaceuticals & cosmetics
- Packaging industry (bottling pumps)
- Maximum temperature applications of up to +400 °C

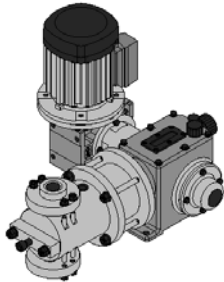

P_ORL_071_SW1
Orlita® PS 18-36

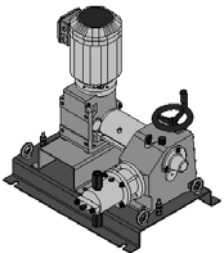

P_ORL_072_SW1
Orlita® PS 80-30

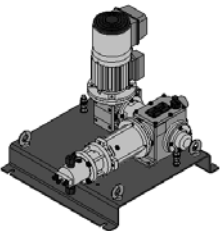

P_ORL_073_SW1
Orlita® PS 18-12 high-temperature

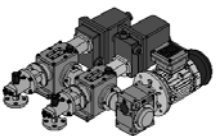

P_ORL_074_SW1
Orlita® PS 35-7-7

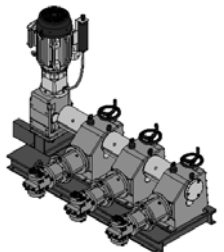

P_ORL_075_SW1
Orlita® PS 600-40-40-40





2.22 Plunger Metering Pump Orlita® PS

Pump type	Plunger Ø	Stroke volume	Max. capacity (theo.) in l/h at strokes/min (50 Hz)						Max. pressure
			58	73	91	112	145	207	
	mm	ml/stroke	l/h	l/h	l/h	l/h	l/h	l/h	bar
PS 18/	5	0.29	1.0	1.2	1.6	1.9	2.5	3.6	250
PS 18/	6	0.42	1.4	1.8	2.3	2.8	3.6	5.2	250
PS 18/	7	0.58	2.0	2.5	3.1	3.8	5.0	7.1	250
PS 18/	8	0.75	2.6	3.2	4.1	5.0	6.5	9.3	250
PS 18/	10	1.18	4.1	5.1	6.4	7.8	10.2	14.6	200
PS 18/	12	1.70	5.9	7.3	9.2	11.3	14.7	21.0	139
PS 18/	16	3.02	10.5	13.1	16.4	20.1	26.2	37.4	78
PS 18/	20	4.71	16.4	20.5	25.6	31.5	41.0	58.5	50
PS 18/	25	7.36	25.6	32.0	40.0	49.2	64.0	91.5	32
PS 18/	30	10.60	36.9	46.1	57.6	70.9	92.2	131.7	16
PS 18/	36	15.27	53.1	66.4	83.0	102.1	132.8	189.7	15
PS 18/	40	18.85	65.6	82.0	102.4	126.1	163.9	234.2	10
PS 18/	50	29.45	102.4	128.1	160.1	197.1	256.2	366.0	8

Pump type	Plunger Ø	Stroke volume	Max. capacity (theo.) in l/h at strokes/min (50 Hz)						Max. pressure
			58	73	91	112	145	207	
	mm	ml/stroke	l/h	l/h	l/h	l/h	l/h	l/h	bar
PS 35/	7	0.77	2.6	3.3	4.1	5.1	6.7	9.5	630
PS 35/	8	1.01	3.5	4.3	5.4	6.7	8.7	12.4	400
PS 35/	10	1.57	5.4	6.8	8.5	10.5	13.6	19.5	400
PS 35/	12	2.26	7.8	9.8	12.3	15.1	19.6	28.1	250
PS 35/	16	4.02	13.9	17.4	21.8	26.9	34.9	49.9	156
PS 35/	20	6.28	21.8	27.3	34.1	42.0	54.6	78.0	100
PS 35/	25	9.82	34.1	42.7	53.3	65.7	85.4	122.0	64
PS 35/	30	14.14	49.2	61.5	76.8	94.6	122.9	175.7	44
PS 35/	36	20.36	70.8	88.5	110.6	136.2	177.1	253.0	30
PS 35/	40	25.13	87.4	109.3	136.6	168.2	218.6	312.3	25
PS 35/	50	39.27	136.6	170.8	213.5	262.8	341.6	488.0	16
PS 35/	65	66.37	230.9	288.6	360.8	444.1	577.3	824.8	9
PS 35/	80	100.53	349.8	437.3	546.6	672.7	874.6	1,249.4	6
PS 35/	100	157.08	546.6	683.3	854.1	1,051.2	1,366.5	1,952.2	4

Pump type	Plunger Ø	Stroke volume	Max. capacity (theo.) in l/h at strokes/min (50 Hz)						Max. pressure	
			78	98	122	134	155	182		193
	mm	ml/stroke	l/h	l/h	l/h	l/h	l/h	l/h	bar	
PS 80/	20	6.28	29	37	46	50	58	68	72	400
PS 80/	25	9.82	45	57	71	79	91	107	113	250
PS 80/	30	14.14	66	83	103	113	131	154	163	178
PS 80/	36	20.36	95	119	149	164	189	222	235	123
PS 80/	40	25.13	117	148	184	202	233	274	290	100
PS 80/	50	39.27	183	231	287	316	365	428	453	64
PS 80/	60	56.55	264	333	414	455	526	617	653	44
PS 80/	65	66.37	310	390	486	535	617	724	766	37
PS 80/	80	100.53	470	592	736	810	935	1,097	1,161	25
PS 80/	100	157.08	734	925	1,150	1,266	1,461	1,714	1,814	16
PS 80/	125	245.44	1,148	1,445	1,797	1,978	2,283	2,679	2,835	10
PS 80/	140	307.88	1,440	1,813	2,254	2,482	2,864	3,360	3,557	8
PS 80/	160	402.12	1,880	2,368	2,944	3,242	3,741	4,389	4,646	6

Important note:

All performance data is stated at 50 Hz motor frequency

Abridged presentation of our complete product range. Other types on request

2.22 Plunger Metering Pump Orlita® PS

2

Pump type	Plunger Ø	Stroke volume	Max. capacity (theo.) in l/h at strokes/min (50 Hz)						Max. pressure
			107 l/h	117 l/h	134 l/h	152 l/h	171 l/h	200 l/h	
	mm	ml/stroke							bar
PS 180/	30	28.27	181	199	226	257	290	339	229
PS 180/	36	40.72	262	286	326	370	417	489	159
PS 180/	40	50.27	323	353	403	457	515	604	125
PS 180/	50	78.54	505	552	630	714	805	943	80
PS 180/	54	91.61	589	644	735	833	939	1,100	70
PS 180/	65	132.73	854	934	1,065	1,207	1,361	1,594	48
PS 180/	70	153.94	990	1,083	1,235	1,400	1,579	1,849	40
PS 180/	80	201.06	1,293	1,415	1,613	1,829	2,062	2,416	32
PS 180/	94	277.59	1,786	1,953	2,227	2,526	2,847	3,335	23
PS 180/	125	490.87	3,158	3,455	3,939	4,467	5,036	5,898	13
PS 180/	140	615.75	3,962	4,334	4,941	5,603	6,317	7,399	10
PS 180/	160	804.25	5,175	5,660	6,454	7,318	8,251	9,664	8
PS 180/	200	1,256.64	8,086	8,845	10,085	11,435	12,892	15,100	5

Pump type	Plunger Ø	Stroke volume	Max. capacity (theo.) in l/h at strokes/min (50 Hz)						Max. pressure
			99 l/h	117 l/h	134 l/h	156 l/h	173 l/h	204 l/h	
	mm	ml/stroke							bar
PS 600/	30	28.27	168	198	227	264	293	345	400
PS 600/	36	40.27	242	285	327	381	422	497	353
PS 600/	40	50.27	299	352	403	470	521	614	286
PS 600/	50	78.54	467	551	630	735	814	959	183
PS 600/	54	91.61	545	643	735	857	949	1,119	157
PS 600/	65	132.73	789	932	1,067	1,243	1,376	1,621	100
PS 600/	70	153.94	916	1,080	1,236	1,441	1,596	1,880	93
PS 600/	80	201.06	1,196	1,411	1,616	1,882	2,084	2,456	71
PS 600/	94	277.59	1,651	1,949	2,229	2,599	2,878	3,391	51
PS 600/	125	490.87	2,921	3,446	3,946	4,596	5,090	5,998	29
PS 600/	140	615.75	3,664	4,323	4,951	5,766	6,385	7,523	23
PS 600/	160	804.25	4,785	5,647	6,466	7,531	8,339	9,827	16
PS 600/	200	1,256.64	7,477	8,823	10,104	11,768	13,030	15,354	11

Pump type	Plunger Ø	Stroke volume	Max. capacity (theo.) in l/h at strokes/min (50 Hz)						Max. pressure
			93 l/h	106 l/h	125 l/h	143 l/h	169 l/h	191 l/h	
	mm	ml/stroke							bar
PS 1400/	40	75.40	419	480	565	647	766	864	400
PS 1400/	50	117.81	654	750	884	1,011	1,197	1,350	275
PS 1400/	60	169.65	943	1,080	1,273	1,456	1,724	1,944	190
PS 1400/	70	230.91	1,283	1,470	1,733	1,983	2,346	2,646	140
PS 1400/	80	301.59	1,676	1,920	2,263	2,590	3,065	3,456	107
PS 1400/	94	416.39	2,314	2,651	3,125	3,576	4,231	4,772	77
PS 1400/	125	736.31	4,093	4,689	5,527	6,323	7,483	8,439	44
PS 1400/	140	923.63	5,134	5,882	6,933	7,932	9,387	10,587	35
PS 1400/	160	1,206.37	6,706	7,683	9,055	10,360	12,261	13,827	25
PS 1400/	200	1,884.96	10,478	12,005	14,149	16,188	19,157	21,606	17
PS 1400/	280	3,694.51	20,538	23,530	27,732	31,729	37,549	42,348	8

Important note:

All performance data is stated at 50 Hz motor frequency

Abridged presentation of our complete product range. Other types on request



2.23 Plunger Metering Pump Orlita® DR

2.23.1

Plunger Metering Pump Orlita® DR

For the precise metering of high-viscosity and extremely high-viscosity media even containing solid fractions

Capacity range of single pump: 0 – 4,000 l/h, 400 – 4 bar

The plunger metering pump Orlita® DR does not need valves and can be operated within a broad stroke rate range. It is therefore suitable for use with high-viscosity and extremely high-viscosity media of up to 10⁶ mPas within a wide temperature range from -40 °C to 400 °C, for example in the food industry.



Orlita® DR plunger metering pumps (DR 15 to DR 150) are special pumps for high-viscosity and extremely high-viscosity media, which can also contain solids. The pump can be operated within a broad stroke rate range due to its operation without valves.

Your benefits

Optimum adaptation to processes with high-viscosity and extremely high-viscosity media, even containing solid fractions:

- Low-wear and precise operation even at high pressures, thanks to the rotary plunger with abrasion-resistant / wear-resistant surface coating
- Valve-free operation guarantees a broad stroke rate range
- Wide range of uses: Operating pressure of up to 400 bar, temperature range of - 40 °C to + 400 °C
- Pump direction can be selected depending on the fitting position of the plunger
- A reverse suction effect is continuously adjustable by rotating the pump head around its longitudinal axis
- Power end configuration ideal for installation in any position (vertical or horizontal)
- Excellent hydraulic efficiency
- 4 different gear ratios are available
- Customised designs are available on request

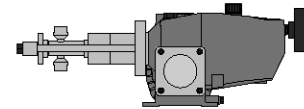

P_ORL_0020_SW
Orlita® DR

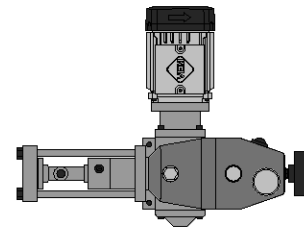

P_ORL_0021_SW
Orlita® DR 15/12

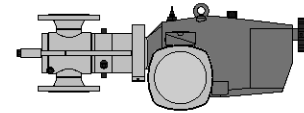

P_ORL_0022_SW
Orlita® 150/90

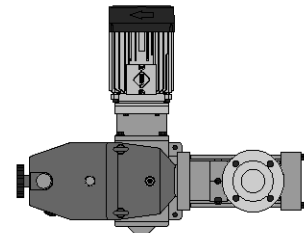

P_ORL_0023_SW
Orlita® DR 150/90

Technical Details

- DR 15 - Stroke length: 0-15 mm, Rod force: 1,800 N
- DR 150 - Stroke length: 0-32 mm, Rod force: 15,000 N
- Stroke length adjustment range: 0 – 100% in operation and idle
- Stroke length adjustment: manually by means of a manual adjustment wheel and scaled display (optionally with electric actuator or control drive)
- Metering reproducibility is better than ± 0.5% within the stroke length adjustment range of 10 to 100% under defined conditions and with proper installation
- Wetted materials: Stainless steel, special designs are available on request
- A wide range of power end versions is available: Three-phase standard motors, motors for use in Exe and Exde areas and different flange designs for use in customer-specific motors
- Degree of protection: IP 55
- Temperature range - 40 °C to + 400 °C
- The interplay between the plunger and cylinder responsible for the sealing effect, is selected depending on the viscosity
- Turret on the rear head end as a circular collecting vessel
- The turret is sealed by elastomer lip sealing rings
- Design in compliance with API 675 among others

Field of application

- Metering of high-viscosity and extremely high-viscosity media containing some solid fractions, for example in the food industry.



2.23 Plunger Metering Pump Orlita® DR

Pump type	Plunger Ø mm	Stroke volume ml/stroke	Capacity max. (theo.) in l/h at strokes/min (50 Hz)			Max. pressure bar
			58 l/h	77 l/h	116 l/h	
DR 15/	7	0.58	2.0	2.6	4.0	400
DR 15/	12	1.70	5.9	7.8	11.8	159
DR 15/	18	3.82	13.2	17.7	26.5	70
DR 15/	25	7.36	25.6	34.1	51.2	36
DR 15/	36	15.27	53.1	70.8	106.2	17
DR 15/	50	29.45	102.4	136.6	204.9	9
DR 15/	70	57.73	200.8	267.8	401.7	4

Pump type	Plunger Ø mm	Stroke volume ml/stroke	Capacity max. (theo.) in l/h at strokes/min (50 Hz)				Max. pressure bar
			58 l/h	77 l/h	116 l/h	145 l/h	
DR 150/	12	3.62	12.5	16.7	25.1	31.4	400
DR 150/	18	8.14	28.3	37.7	56.6	70.8	400
DR 150/	25	15.71	54.6	72.8	109.3	136.6	250
DR 150/	36	32.57	113.3	151.1	226.7	283.3	147
DR 150/	50	62.83	218.6	291.5	437.3	546.6	76
DR 150/	70	123.15	428.5	571.4	857.1	1,071.4	38
DR 150/	90	203.58	708.4	944.5	1,416.8	1,771.1	23
DR 150/	120	361.91	1,259.4	1,679.2	2,518.9	3,148.6	13
DR 150/	140	492.60	1,714.2	2,285.6	3,428.5	4,285.6	9

Important note:

All performance data is stated at 50 Hz motor frequency

Abridged presentation of our complete product range. Other types on request





2.24 Diaphragm Process Pump Zentriplex

2.24.1

Diaphragm Process Pump Zentriplex

The innovative process metering pump with the ideal dimensions and excellent efficiency.

Capacity range 424 – 8,000 l/h, 367 – 36 bar



The Zentriplex guarantees excellent performance and provides outstanding efficiency as an oscillating triplex process diaphragm pump, with an extremely small footprint thanks to the space-saving arrangement of the pump and drive unit. It also stands out on account of its efficiency, as minimal material and labour are required.

The Zentriplex is an oscillating process diaphragm metering pump, which has a very small footprint thanks to its unconventional design, as the pump and drive unit are mounted above each other to save space. Diaphragm dosing heads and hydraulic units are arranged in a star pattern around the drive unit, resulting in minimised loads and significantly lower material and drive requirements. The Zentriplex is designed in compliance with API 674.

Your benefits

Excellent conservation of resources:

- Excellent energy efficiency.
- Diaphragm replacement without dismantling the suction and discharge lines ensures cost-effective maintenance of the pump
- Low noise emissions
- Very quiet thanks to complete balancing of masses
- Only one connection required by the customer. Collective discharge and suction lines are integrated in the pump
- Low flow rate pulsation
- Customised designs are available on request

Technical Details

- Stroke length: 40 mm, Rod force: 18,000 N fixed stroke pump
- Metering reproducibility is better than $\pm 1\%$ under defined conditions and with proper installation
- PTFE multi-layer diaphragm with electrical diaphragm rupture warning system via a contact
- Integrated hydraulic relief and bleed valve
- Wetted materials: Stainless steel, special designs are available on request
- A wide range of motor versions is available: Three-phase standard motors with varied adjustment ranges, motors for use in Exe and Exde areas, different flange designs for use in customer-specific motors
- Degree of protection: IP 55
- Design in compliance with API 674

Field of application

- Chemical industry
- Petrochemical industry
- Refineries
- Oil and gas industry

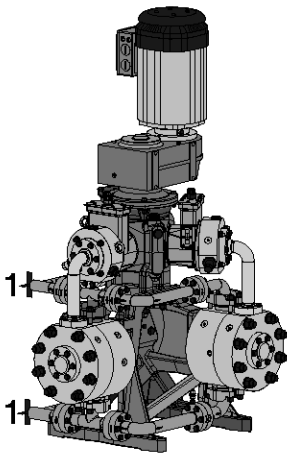

P_PZ_0009_SW1
Process diaphragm pump Zentriplex (1= customer-side connection)

2.24 Diaphragm Process Pump Zentriplex

Technical Data

Plunger Ø mm	Stroke volume ml/ stroke	Theoretical pump capacity Q_{th} at a stroke rate n in rpm					Max. operating pressure bar	Efficiency at 100% pressure	Efficiency at 50% pressure	Standard type of valve
		120 [3] l/h	145 [4] l/h	170 [5] l/h	200 [6] l/h	220 [7] l/h				
25	58.90	424	512	601	707	778	367	0.78	0.83	DN 10
26	63.71	459	554	650	765	841	339	0.78	0.83	DN 10
30	84.82	611	738	865	1,018	1,120	255	0.81	0.85	DN 15
36	122.15	879	1,063	1,246	1,466	1,612	177	0.84	0.87	DN 20
44	182.46	1,314	1,587	1,861	2,190	2,409	118	0.85	0.88	DN 20
60	339.29	2,443	2,952	3,461	4,072	4,479	64	0.90	0.92	DN 25
70	461.81	3,325	4,018	4,711	5,542	6,096	47	0.90	0.92	DN 32
80	603.19	4,343	5,248	6,152	7,238	7,962	36	0.90	0.92	DN 32

Note:

Abridged presentation of our complete product range. Other piston diameters (14 - 75 mm) on request

Materials in Contact With the Medium

Dosing head complete

Dosing head	Diaphragm retaining screw	Diaphragm	Manifold Suction/pressure connector	Seal, manifold
Stainless steel 1.4404	Stainless steel 1.4462	PTFE multi-layer diaphragm	Stainless steel 1.4571	Viton O-ring with seamless FEP jacket

Ball valve DN 10

Suction/pressure connector	Seal valve/head	Valve ball	Valve seat	Valve housing
Stainless steel 1.4571	Stainless steel 1.4571	Al ₂ O ₃ ceramic	Stainless steel 1.4404	Stainless steel 1.4404

Plate valve DN 15 / DN 20 / DN 25 / DN 32

Suction/pressure connector	Seal valve/head	Valve plate	Valve seat	Valve housing
Stainless steel 1.4571	Stainless steel 1.4571	Stainless steel 1.4462	Stainless steel 1.4571	Stainless steel 1.4571

Further material versions and details available on request.

Motor and Gearbox Data

Motors and gearboxes from 7.5 to 15 kW are available for the Zentriplex product range. Further options and details available upon request.

Standard gear motor 7.5 kW, 9.2 kW, 11 kW, 15 kW	3 ph, IP 55	400/690V	50/60 Hz	Control range 1:5
Ex gear motor EExde IICT4 11 kW, 15 kW	3 ph, IP 65	400/690V	50/60 Hz	Control range 1:5
Standard external gearbox 11 kW...15 kW	IP 55			Version according to DIN/ISO standard flange
Standard external gearbox 11 kW...15 kW	IP 55			NEMA flange version
Ex gearbox 2 IIGD c,k T4/T120C external 11 kW...15 kW	IP 55			Version according to DIN/ISO standard flange
Ex gearbox 2 IIGD c,k T4/T120C external 11 kW...15 kW	IP 55			NEMW flange version



2.25 Hydraulic/Mechanical Accessories

Hydraulic/mechanical accessories

Hydraulic / mechanical accessories for metering pumps such as injection valves and foot valves, can be found in Chapter 1.5, sorted by nominal width DN 8 ... DN 40:

Please observe the permitted pressure ratings or material combinations when selecting. Further accessories are available on request.

Electrical accessories

Accessories for metering pumps, such as frequency converters etc., can be found in Chapter 1.6, sorted by motor capacity DN 8 ... DN 40.

2.25.1 Return/Pressure Relief Valve, Spring-loaded

Spring-loaded valves, inline version, designed as pump valves, i.e. to cope with a very high number of load cycles. Also suitable for use without pulsation damper.

Features:

- Female thread on both sides or with sealing surface
- For bracing between 2 flanges
- PN 200 or PN 400
- Settings factory-set
- Standard design in stainless steel, hastelloy also available on request, as is Inconel

Also available heatable on request.

DN	Adjustable pressure	Construction	Order no.
6	2.0 bar	Ball	1020074
6	4.0 bar	Ball	1019224
6	8.0 – 9.0 bar	Ball	1019097
10	2.0 bar	Cone, fixed	1019649
10	3.0 – 6.0 bar	Cone, adjustable	1023053
10	8.0 – 14.0 bar	Cone, adjustable	1024065
16	2.0 bar	Cone, fixed	1017937
16	3.0 bar	Cone, fixed	1035266
16	4.5 – 5.4 bar	Cone, fixed	1017936
25	1.0 – 2.0 bar	Cone, fixed	1021843



2.25 Hydraulic/Mechanical Accessories

2.25.2 Safety Valve

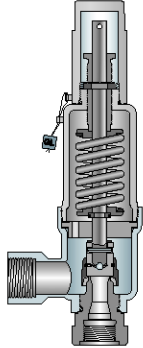

P_AC_0231_SW

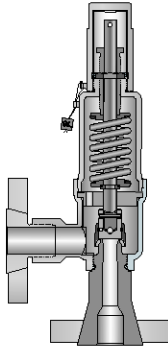

P_AC_0232_SW

Regulations:

Safety valves are designed to comply with the following regulations:

- Pressurised Vessel and Steam Boiler Directive
- TRD 421, 721
- TRB 403
- AD 2000 Bulletins A2 and A4
- DIN EN ISO 4126
- Pressure Equipment Directive 97/23/EC
- ASME Code, Sections II and VIII
- API 526, 520, 527
- Others

The relevant product-specific certificates are available to prove compliance with these regulations and thus also the safety of the products.

Safety valves carry a parts label (specification label) stipulating the following data:

- Order date (serial no.)
- Technical data
- Set pressure
- VdTÜV Parts test number
- CE mark with number of nominated centre
- Further data, e.g. UV stamp with ASME-approved safety valves

Inspection / Labelling:

Following adjustment and inspection, every safety valve is sealed by the manufacturer.

Connectors: NPT threaded connectors, threaded sockets, flange mountings comply with DIN / ANSI. Other connections are available on request.

Inlet body material

Material description	X 14 CrNiMo 17-12-2
Material no.	1.4404
ASME	316L

Dimensions, pressure ranges, weights

	Standard 10 mm
Pressure rating at inlet	320 PN
Pressure rating at outlet	160 PN
Min. response pressure	0.1 bar
Max. response pressure (4373 / 4374)	68 bar
Narrowest flow cross-section	78.5 mm ²
Narrowest flow diameter	10 mm
Leg length (outlet / inlet)	30 mm / 33 mm
Pin length (G 1/2 / G 3/4)	15 mm / 16 mm
Flange design	100 mm
Height (H2 / H4)	137/162 mm
Weight	1.2 kg





2.25 Hydraulic/Mechanical Accessories

2.25.3

Pulsation Damper

Pulsation dampers with separating membrane / bubble / bellows for providing separation between the gas cushion and metered chemical are used for low-pulsation metering as well as for reducing flow resistance in long metering lines and with viscous media. The response pressure of the gas cushion should be approx. 60-80% of the operating pressure.

Important: A pressure relief valve should always be fitted with an adjustable back pressure valve when using a pulsation damper.

Bladder dampers, metal

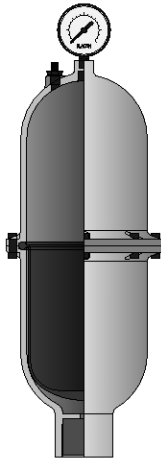

Volume	0.066 - 379 l
Pressure	20.7 bar
Material of bladder/diaphragm	EPDM or FKM
Housing material	316 L stainless steel, Hastelloy C, PTFE

Further material versions and details available on request.

P_AC_0258_SW1

Bladder damper, plastic

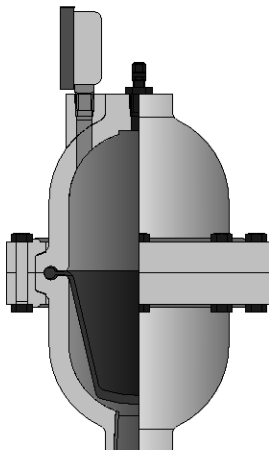

Volume	0.066 - 19 l
Pressure	17.2 bar
Material of bladder/diaphragm	EPDM or FKM
Housing material	PVDF

Further material versions and details available on request.

P_AC_0259_SW1

2.25 Hydraulic/Mechanical Accessories

2

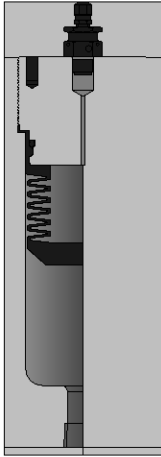

P_AC_0260_SW1

Bladder damper, high pressure

Volume	0.13 - 0.39 l
Pressure	793 bar
Material of bladder/diaphragm	EPDM or FKM
Housing material	316 L stainless steel, Hastelloy C, Alloy 20

Further material versions and details available on request.

Diaphragm damper with PTFE diaphragm

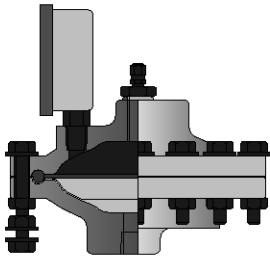

P_AC_0261_SW1

Volume	0.20
Pressure	137 bar
Material of bladder/diaphragm	PTFE
Housing material	316 L stainless steel, Hastelloy C, Alloy 20

Further material versions and details available on request.



Data Required for Specification of Metering Pump and Accessories

Pump Specification Data

Min./max. required feed rate l/h _____
 Available power supply _____ V, _____ Hz
 Min./max. operating temperature °C _____
 Properties of process chemical _____
 Name, concentration % _____
 Solids content % _____
 Dynamic viscosity mPa (= cP) _____
 Vapour pressure at operating temperature bar _____
 Remarks, e.g. abrasive, _____
 gaseous, flammable, _____
 corrosive towards _____

Suction conditions:

Min./max. suction lift m _____
 Min./max. positive suction head m _____
 Pressure in chemical tank bar _____
 Suction line length m _____
 Suction line diameter mm _____

Discharge conditions:

Min./max. back pressure bar _____
 Min./max. discharge head m _____
 Min./max. negative discharge head m _____
 Discharge line length m _____
 Discharge line diameter mm _____
 Number of valves and fittings in suction and discharge line _____

Data required for proportional dosing:

Water flow Q min./max. m³/h _____
 Required final concentration g/m³, ppm _____

Example:

A required dose in mg/l = g/m³ = ppm

(Water flow Q max. 50 m³/h)

Pulse spacing (flow volume per pulse) of water meter 5 l.

Process fluid = sodium hypochlorite solution Na OCl with 12 % chlorine (by weight) = 120 g/kg = 150 g/l = 150 mg/ml

Selected dosing pump GMXa 1604NPT2 NPB2 with 0.3 ml/per stroke volume, at max. 10800 strokes/h.

Variables: pump type, pulse spacing and concentration. The stroke rate (max. throughput l/h: pulse spacing l/pulse = 50,000 l/h : 5 l/pulse = 10000 pulses/h) must not exceed the max. stroke frequency (10800 strokes/h) of the dosing pump.

$$\text{Feed quantity} = \frac{\text{water throughput Q max. (l/h)} \times \text{stroke volume (l)}}{\text{pulse spacing (l)}} = \frac{50,000 \text{ l} \times 0.0003 \text{ l}}{\text{h} \times 5 \text{ l}} = 3 \text{ l/h}$$

$$\begin{aligned} \text{Final dose} &= \frac{\text{concentration (mg/ml)} \times \text{stroke volume (l)}}{\text{pulse spacing (l)}} = \frac{150 \text{ mg} \times 0.3 \text{ ml}}{\text{ml} \times 5 \text{ l}} = 9 \text{ mg/l} \\ &= 9 \text{ g/m}^3 \\ &= 9 \text{ ppm chlorine Cl}_2 \end{aligned}$$

SG_0037_DE



ProMinent® Chemical Resistance List

Resistance of Materials Used in Liquid Ends to the Chemicals Most Frequently Used

The data apply to standard conditions (20 °C, 1,013 mbar).

s	= saturated solution in water
+	= resistant
+/o	= largely resistant
o	= conditionally resistant
-	= not resistant
n	= resistance not known
=>	= see
*	= for bonded connections, the resistance of the adhesive (e.g. Tangit) is to be considered. (Materials of the types 'o' and '-' are not recommended!)
**	= does not apply to glass fibre reinforced material

Concentration data are stated in weight percent, relative to aqueous solutions. If percentages are stated for the level of resistance, this level of resistance is only valid up to this concentration.

NOTE:

The elastomers **CSM (Hypalon®)** and **IIR (butyl rubber)** used as diaphragm materials in pulsation dampers have properties similar to **EPDM**.

PTFE is resistant to all chemicals in this list.

PTFE filled with carbon, however, is attacked by strong oxidants such as bromine (anhydrous) or concentrated acids (phosphoric acid, sulphuric acid, chromic acid).

The resistance of PVC-U adhesive joints with Tangit deviates from the list below with regard to the following chemicals:

Medium	Concentration range
Sulfochromic acid	≥ 70% H ₂ SO ₄ + 5% K ₂ Cr ₂ O ₇ /Na ₂ Cr ₂ O ₇
Chromic acid	≥ 10% CrO ₃
Hydrochloric acid	≥ 25% HCl
Hydrogen peroxide	≥ 5% H ₂ O ₂
Hydrofluoric acid	≥ 0% HF

Explanation of abbreviations used as column headings:

PMMA:	Polymethylmethacrylate (Acrylic resistance)
PVC:	Polyvinylchloride, rigid, (PVC-U) resistance
PP:	Polypropylene resistance
PVDF:	Polyvinylidene fluoride
1.4404:	Stainless steel 1.4404 & 1.4571 resistance
FKM:	Fluorine Rubber (e.g. Viton® A & B) resistance
EPDM:	Ethylene-Propylene-Dien-rubber resistance
PharMed®:	PharMed® resistance
PE:	Polyethylene resistance
2.4819:	Hastelloy C-276 resistance
WGK:	Water endangering class

Viton® is a registered trademark of DuPont Dow Elastomers

Water endangering classes (WGK):

1	= slightly hazardous to water
2	= hazardous to water
3	= severely hazardous to water
(X)	= no classification. Classification according to conclusion by analogy. To be used under reserve.

Safety data sheets

Safety data sheets on our products in a number of different languages are provided on our website.

www.prominent.com/MSDS



ProMinent® Chemical Resistance List

The data is taken from relevant manufacturer's documentation and our own tests. Resistance of materials is also dependant on other factors, e.g. operating conditions, conditions of surfaces etc, and so this list must be treated as an initial guide only. It cannot claim to offer any guarantees. It should be taken into consideration in particular that usual dosing media are compounds, and their corrosiveness cannot be deducted simply by adding the corrosiveness of each single component. In such cases the chemical producers' data of the material compatibility are to be considered as a matter of prime importance for the material choice. A safety data sheet does not give this data and therefore cannot take the place of the technical documentation on the application.

Chemical	Formula	Conc	PMMA	PVC	PP	PVDF	1.4404	FKM	EPDM	PharMed®	PE	2.4819	WPC
Acetaldehyde	CH ₃ CHO	100%	-	-	o	-	+	-	+/o	-	+	+	2
Acetamide	CH ₃ CONH ₂	s	+	+	+	+	+	o	+	+/o	+	+	1
Acetic Acid	CH ₃ COOH	100%	-	50%	+	+	+	-	o	60%	70%	+	1
Acetic Anhydride	(CH ₃ CO) ₂ O	100%	-	-	o	-	+	-	+/o	+	o	+	1
Acetic Ether => Ethyl Acetate													
Acetone	CH ₃ COCH ₃	100%	-	-	+	-	+	-	+	-	+	+	1
Acetophenone	C ₆ H ₅ COCH ₃	100%	-	n	+	-	+	-	+	n	+	+	
Acetyl Chloride	CH ₃ COCl	100%	-	+	n	-	o	+	-	o	n	+	1
Acetylacetone	CH ₃ COCH ₂ COCH ₃	100%	-	-	+	-	+	-	+	n	+	+	1
Acetylene Dichloride => Dichloro Ethylene													
Acetylene Tetrachloride => Tetrachloro Ethane													
Acrylonitril	CH ₂ =CH-CN	100%	-	-	+	+	+	-	-	-	+	+	3
Adipic Acid	HOOC(CH ₂) ₄ COOH	s	+	+	+	+	+	+	+	+/o	+	+	1
Allyl Alcohol	CH ₂ CHCH ₂ OH	96%	-	o	+	+	+	-	+	o	+	+/o	2
Aluminium Acetate	Al(CH ₃ COO) ₃	s	+	+	+	+	+	+	+	+	+	+/o	1
Aluminium Bromide	AlBr ₃	s	+	+	+	+	n	+	+	+	+	+	2
Aluminium Chloride	AlCl ₃	s	+	+	+	+	-	+	+	+	+	+	1
Aluminium Fluoride	AlF ₃	10%	+	+	+	+	-	+	+	+	+	+/o	1
Aluminium Hydroxide	Al(OH) ₃	s	+	+	+	+	+	+	+	+	+	+	1
Aluminium Nitrate	Al(NO ₃) ₃	s	+	+	+	+	+	+	+	+	+	+	1
Aluminium Phosphate	AlPO ₄	s	+	+	+	+	+	+	+	+	+	+	1
Aluminium Sulphate	Al ₂ (SO ₄) ₃	s	+	+	+	+	+	+	+	+	+	+	1
Ammonium Acetate	CH ₃ COONH ₄	s	+	+/o	+	+	+	+	+	+	+	+	1
Ammonium Bicarbonate	NH ₄ HCO ₃	s	+	+	+	+	+	+	+	+	+	+	1
Ammonium Carbonate	(NH ₄) ₂ CO ₃	40%	+	+	+	+	+	+	+	+	+	+	1
Ammonium Chloride	NH ₄ Cl	s	+	+	+	+	-	+	+	+	+	+/o	1
Ammonium Fluoride	NH ₄ F	s	+	o	+	+	o	+	+	+	+	+	1
Ammonium Hydroxide	"NH ₄ OH"	30%	+	+	+	+	+(25°C)	+	-	+	+	+	2
Ammonium Nitrate	NH ₄ NO ₃	s	+	+	+	+	+	+	+	+	+	+	1
Ammonium Oxalate	(COONH ₄) ₂ * H ₂ O	s	+	+	+	+	+	+	+	+	+	+	1
Ammonium Perchlorate	NH ₄ ClO ₄	10%	+	+	+	+	+	+	+	+	+	+	1
Ammonium Peroxodisulphate	(NH ₄) ₂ S ₂ O ₈	s	+	+	+	+	5%	+	+	+	+	5%	2
Ammonium Phosphate	(NH ₄) ₃ PO ₄	s	+	+	+	+	10%	+	+	+	+	10%	1
Ammonium Sulphate	(NH ₄) ₂ SO ₄	s	+	+	+	+	10%	+	+	+	+	10%	1
Ammonium Sulphide	(NH ₄) ₂ S	s	+	+	+	+	n	+	+	n	+	n	2
Ammoniumaluminium Sulphate	NH ₄ Al(SO ₄) ₂	s	+	+	+	+	+	+	+	+	+	+	1
Amyl Alcohol	C ₅ H ₁₁ OH	100%	+	+	+	+	+	-	+	-	+	+	1
Aniline	C ₆ H ₅ NH ₂	100%	-	-	+	+	+	-	+/o	o	+	+	2
Aniline Hydrochloride	C ₆ H ₅ NH ₂ * HCl	s	n	+	+	+	-	+/o	+/o	o	+	+	2
Antimony Trichloride	SbCl ₃	s	+	+	+	+	-	+	+	+	+	n	2
Aqua Regia	3 HCl + HNO ₃	100%	-	+	-	+	-	-	o	-	-	-	2
Arsenic Acid	H ₃ AsO ₄	s	+	+	+	+	+	+	+	o	+	+	3
Barium Carbonate	BaCO ₃	s	+	+	+	+	+	+	+	+	+	+	1
Barium Chloride	BaCl ₂	s	+	+	+	+	-	+	+	+	+	+	1
Barium Hydroxide	Ba(OH) ₂	s	+	+	+	+	+	+	+	+	+	+	1
Barium Nitrate	Ba(NO ₃) ₂	s	+	+	+	+	+	+	+	+	+	+	1
Barium Sulphate	BaSO ₄	s	+	+	+	+	+	+	+	+	+	+	1
Barium Sulphide	BaS	s	+	+	+	+	+	+	+	+	+	+	(1)
Benzaldehyde	C ₆ H ₅ CHO	100%	-	-	+	-	+	+	+	-	o	+	1
Benzene	C ₆ H ₆	100%	-	-	o	+	+	o	-	-	o	+	3
Benzene Sulphonic Acid	C ₆ H ₅ SO ₃ H	10%	n	n	+	+	+	-	-	-	n	+	2
Benzoic Acid	C ₆ H ₅ COOH	s	+	+	+	+	+	+	+	+/o	+	+	1
Benzoyl Chloride	C ₆ H ₅ COCl	100%	-	n	o	n	o	+	+	n	o	+	2
Benzyl Alcohol	C ₆ H ₅ CH ₂ OH	100%	-	-	+	+	+	+	-	+	+	+	1
Benzyl Benzoate	C ₆ H ₅ COOC ₇ H ₇	100%	-	-	+	o	+	+	-	-	+	+	2
Benzyl Chloride	C ₆ H ₅ CH ₂ Cl	90%	-	n	o	+	+	+	-	-	o	+	2
Bitter Salt => Magnesium Sulphate													
Bleach => Sodium Hypochlorite													
Blue Vitriol => Copper Sulphate													
Borax => Sodium Tetraborate													



ProMinent® Chemical Resistance List

Chemical	Formula	Conc	PMMA	PVC	PP	PVDF	1.4404	FKM	EPDM	PharMed®	PE	2.4819	WPC
Boric Acid	H ₃ BO ₃	s	+	+	+	+	+	+	+	+	+	+	1
Brine		s	+	+/o	+	+	+/o	+	+	+	+	+	1
Bromine (dry)	Br ₂	100%	-	-	-	+	-	-	-	-	-	+	2
Bromine Water	Br ₂ + H ₂ O	s	-	+	-	+	-	-	-	n	-	n	(2)
Bromo Benzene	C ₆ H ₅ Br	100%	n	n	o	+	+	o	-	-	o	+	2
Bromochloro Methane	CH ₂ BrCl	100%	-	-	-	+	+	n	+/o	-	o	+	2
Bromochlorotrifluoro Ethane	HCClBrCF ₃	100%	-	-	o	+	+	+	-	+	o	+	(3)
Butanediol	HOC ₄ H ₈ OH	10%	n	+	+	+	+	o	+	+	+	+	1
Butanetriol	C ₄ H ₁₀ O ₃	s	+	+	+	+	+	o	+	+	+	+	1
Butanol	C ₄ H ₉ OH	100%	-	+	+	+	+	o	+/o	-	+	+	1
Butyl Acetate	C ₇ H ₁₃ O ₂	100%	-	-	+	+	+	-	-	+/o	+	+	1
Butyl Acetate	CH ₃ COOC ₄ H ₉	100%	-	-	o	+	+	-	+/o	+/o	-	+	1
Butyl Alcohol => Butanol													
Butyl Amine	C ₄ H ₉ NH ₂	100%	n	n	n	-	+	-	-	n	+	+	1
Butyl Benzoate	C ₆ H ₅ COOC ₄ H ₉	100%	-	-	o	n	+	+	+	-	o	+	2
Butyl Mercaptane	C ₄ H ₉ SH	100%	n	n	n	+	n	+	-	n	n	n	3
Butyl Oleate	C ₂₂ H ₄₂ O ₂	100%	n	n	n	+	+	+	+/o	n	n	+	1
Butyl Stearate	C ₂₂ H ₄₄ O ₂	100%	o	n	n	+	+	+	-	n	n	+	1
Butyraldehyde	C ₃ H ₇ CHO	100%	-	n	+	n	+	-	+/o	-	+	+	1
Butyric Acid	C ₃ H ₇ COOH	100%	5%	20%	+	+	+	+	+	+/o	+	+	1
Calcium Acetate	(CH ₃ COO) ₂ Ca	s	+	+	+	+	+	+	+	+	+	+	1
Calcium Bisulphite	Ca(HSO ₃) ₂	s	+	+	+	+	+	+	+	+	+	+	(1)
Calcium Carbonate	CaCO ₃	s	+	+	+	+	+	+	+	+	+	+	1
Calcium Chloride	CaCl ₂	s	+	+	+	+	-	+	+	+	+	+	1
Calcium Cyanide	Ca(CN) ₂	s	+	+	+	+	n	+	+	+	+	n	3
Calcium Hydroxide	Ca(OH) ₂	s	+	+	+	+	+	+	+	+	+	+	1
Calcium Hypochlorite	Ca(OCl) ₂	s	+	+	o	+	-	o	+	+	+	+	2
Calcium Nitrate	Ca(NO ₃) ₂	s	+	50%	50%	+	+	+	+	+	+	+	1
Calcium Phosphate	Ca ₃ (PO ₄) ₂	s	+	+	+	+	+	+	+	+	+	+	1
Calcium Sulphate	CaSO ₄	s	+	+	+	+	+	+	+	+	+	+	1
Calcium Sulphide	CaS	s	+	+	+	+	n	+	+	+	+	+	(2)
Calcium Sulphite	CaSO ₃	s	+	+	+	+	+	+	+	+	+	+	(1)
Calcium Thiosulphate	CaS ₂ O ₃	s	+	+	+	+	-	+	+	+	+	+	1
Carbolic Acid => Phenole													
Carbon Disulphide	CS ₂	100%	-	-	o	+	+	+	-	-	o	+	2
Carbon Tetrachloride	CCl ₄	100%	-	-	-	+	+	+	-	-	o	+	3
Carbonic Acid	"H ₂ CO ₃ "	s	+	+	+	+	+	+	+	+	+	+	1
Caustic Potash => Potassium Hydroxide													
Caustic Soda => Sodium Hydroxide													
Chloric Acid	HClO ₃	20%	+	+	-	+	-	o	o	+	10%	+	2
Chlorinated Lime => Calcium Hypochlorite													
Chlorine Dioxide Solution	ClO ₂ + H ₂ O	0.5%	o	+	o	+ ¹⁾	-	o	-	-	o	+	
Chlorine Water	Cl ₂ + H ₂ O	s	+	+	o	+	-	+	+	-	o	+	
Chloro Benzene	C ₆ H ₅ Cl	100%	-	-	+	+	+	+	-	-	o	+	2
Chloro Ethanol	ClCH ₂ CH ₂ OH	100%	-	-	+	o	+	-	o	+	+	+	3
Chloro Ethylbenzene	C ₆ H ₄ ClC ₂ H ₅	100%	-	-	o	n	+	o	-	-	o	+	(2)
Chloro Phenole	C ₆ H ₄ OHCl	100%	-	n	+	+	+	n	-	-	+	+	2
Chloro Toluene	C ₇ H ₈ Cl	100%	-	-	n	+	+	+	-	-	n	+	2
Chloroacetone	ClCH ₂ COCH ₃	100%	-	-	n	n	+	-	+	-	n	+	3
Chlorobutadiene	C ₄ H ₅ Cl	100%	-	-	n	n	+	+	-	-	n	+	1
Chloroform	CHCl ₃	100%	-	-	o	+	+	+	-	o	-	+	2
Chlorohydrin	C ₃ H ₅ OCl	100%	-	n	+	-	+	+	o	+	+	+	3
Chloroprene => Chlorobutadiene													
Chlorosulphonic Acid	SO ₂ (OH)Cl	100%	-	o	-	+	-	-	-	-	-	o	1
Chrome-alum => Potassium Chrome Sulphate													
Chromic Acid	H ₂ CrO ₄	50%	-	+	o	+	10%	+	-	o	+	10%	3
Chromic-Sulphuric Acid	K ₂ CrO ₄ + H ₂ SO ₄	s	-	+	-	+	n	n	n	-	-	n	3
Chromium Sulphate	Cr ₂ (SO ₄) ₃	s	+	+	+	+	+	+	+	+	+	+	1
Citric Acid	C ₆ H ₈ O ₇	s	+	+	+	+	+	+	+	+	+	+	1
Cobalt Chloride	CoCl ₂	s	+	+	+	+	-	+	+	+	+	+	2
Copper-II-Acetate	Cu(CH ₃ COO) ₂	s	+	+	+	+	+	+	+	+	+	+	3
Copper-II-Arsenite	Cu ₃ (AsO ₃) ₂	s	+	+	+	+	+	+	+	+	+	+	3
Copper-II-Carbonate	CuCO ₃	s	+	+	+	+	+	+	+	+	+	+	2
Copper-II-Chloride	CuCl ₂	s	+	+	+	+	1%	+	+	+	+	+	2
Copper-II-Cyanide	Cu(CN) ₂	s	+	+	+	+	+	+	+	+	+	+	(3)
Copper-II-Fluoride	CuF ₂	s	+	+	+	+	+	+	+	+	+	+	(2)
Copper-II-Nitrate	Cu(NO ₃) ₂	s	+	+	+	+	+	+	+	+	+	+/o	2
Copper-II-Sulphate	CuSO ₄	s	+	+	+	+	+	+	+	+	+	+	2
Cresols	C ₆ H ₄ CH ₃ OH	100%	o	o	+	+	+	+	-	-	+	+	2



ProMinent® Chemical Resistance List

Chemical	Formula	Conc	PMMA	PVC	PP	PVDF	1.4404	FKM	EPDM	PharMed®	PE	2.4819	WPC
Crotonaldehyde	CH ₃ C ₂ H ₂ CHO	100%	n	-	+	+	+	-	+	-	+	+	3
Cubic Nitre => Sodium Nitrate													
Cumene => Isopropyl Benzene													
Cyclo Hexane	C ₆ H ₁₂	100%	+	-	+	+	+	+	-	-	+	o	1
Cyclohexanol	C ₆ H ₁₁ OH	100%	o	+/o	+	+	+	+	-	-	+	+	1
Cyclohexanone	C ₆ H ₁₀ O	100%	-	-	+	-	+	-	+/o	-	+	+	1
Cyclohexyl Alcohol => Cyclohexanol													
Cyclohexylamine	C ₆ H ₁₁ NH ₂	100%	n	n	n	n	+	-	n	n	n	+	2
Decahydronaphthaline	C ₁₀ H ₁₈	100%	-	+/o	o	+	n	o	-	-	o	+	2
Decaline => Decahydronaphthalene													
Dextrose => Glucose													
Diacetonolcohol	C ₆ H ₁₂ O ₂	100%	-	-	+	o	+	-	+	-	+	+	1
Dibromoethane	C ₂ H ₄ Br ₂	100%	-	-	n	+	+	+	-	-	-	+	3
Dibutyl Ether	C ₄ H ₉ OC ₄ H ₉	100%	-	-	+	+	+	-	o	-	+	+	2
Dibutyl Phthalate	C ₁₆ H ₂₂ O ₄	100%	-	-	+	+	+	+	+/o	+	o	+	2
Dibutylamine	(C ₄ H ₉) ₂ NH	100%	n	n	+	+	+	-	-	n	+	+	1
Dichloro Acetic Acid	Cl ₂ CHCOOH	100%	-	+	+	+	+	-	+	o	+	+	1
Dichloro Benzene	C ₆ H ₄ Cl ₂	100%	-	-	o	+	+	+	-	-	o	+	2
Dichloro Butan	C ₄ H ₈ Cl ₂	100%	-	-	o	+	+	+	-	-	o	+	3
Dichloro Butene	C ₄ H ₆ Cl ₂	100%	-	-	o	+	+	o	-	-	o	+	3
Dichloro Ethane	C ₂ H ₄ Cl ₂	100%	-	-	o	+	+	+	-	o	-	+	3
Dichloro Ethylene	C ₂ H ₂ Cl ₂	100%	-	-	o	+	+	o	-	o	-	+	2
Dichloro Methane	CH ₂ Cl ₂	100%	-	-	o	o	o	+	-	o	-	+	2
Dichloroisopropyl Ether	(C ₃ H ₆ Cl) ₂ O	100%	-	-	o	n	+	o	o	-	o	+	(2)
Dicyclohexylamine	(C ₆ H ₁₂) ₂ NH	100%	-	-	o	n	+	-	-	-	o	+	2
Diethyleneglycol	C ₄ H ₁₀ O ₃	s	+	+	+	+	+	+	+	+	+	+	1
Diethyleneglycolethyl Ether	C ₈ H ₁₈ O ₃	100%	n	n	+	+	+	n	+/o	o	+	+	1
Diethylether	C ₂ H ₅ OC ₂ H ₅	100%	-	-	o	+	+	-	-	o	o	+	1
Diglycolic Acid	C ₄ H ₆ O ₅	30%	+	+	+	+	+	+	n	+/o	+	+	3
Dihexyl Phthalate	C ₂₀ H ₂₆ O ₄	100%	-	-	+	+	+	-	n	+	+	+	(1)
Diisobutylketone	C ₉ H ₁₈ O	100%	-	-	+	+	+	-	+	-	+	+	1
Di-iso-nonyl Phthalate	C ₂₆ H ₄₂ O ₄	100%	-	-	+	+	+	n	n	+	+	+	1
Diisopropylketone	C ₇ H ₁₄ O	100%	-	-	+	+	+	-	+	-	+	+	1
Dimethyl Carbonate	(CH ₃ O) ₂ CO	100%	n	n	+	+	+	+	-	n	+	+	1
Dimethyl Ketone => Acetone													
Dimethyl Phthalate	C ₁₀ H ₁₀ O ₄	100%	-	-	+	+	+	-	+/o	+	+	+	1
Dimethylformamide	HCON(CH ₃) ₂	100%	-	-	+	-	+	-	+	+/o	+	+	1
Dimethylhydrazine	H ₂ NN(CH ₃) ₂	100%	n	n	+	n	+	-	+	n	+	+	3
Diocetyl Phthalate	C ₄ H ₄ (COOC ₈ H ₁₇) ₂	100%	-	-	+	+	+	-	+/o	+	+	+	1
Dioxane	C ₄ H ₈ O ₂	100%	-	-	o	-	+	-	+/o	-	+	+	1
Disodium Hydrogenphosphate	Na ₂ HPO ₄	s	+	+	+	+	+	+	+	+	+	+	1
Disulphur Acid -- Oleum													
Disulphur Dichloride	S ₂ Cl ₂	100%	n	n	n	+	n	+	-	-	n	n	
DMF => Dimethylformamide													
Engine Oils		100%	n	+/o	+	+	+	+	-	-	+	+	2
Epsom salts => Magnesium Sulphate													
Ethanol	C ₂ H ₅ OH	100%	-	+	+	+	+	-	+	+	+	+	1
Ethanol Amine	HOC ₂ H ₄ NH ₂	100%	o	n	+	-	+	-	+/o	o	+	+	1
Ethyl Acetate	CH ₃ COOC ₂ H ₅	100%	-	-	35%	+	+	-	+/o	+/o	+	+	1
Ethyl Acrylate	C ₂ H ₃ COOC ₂ H ₅	100%	-	-	+	o	+	-	+/o	-	+	+	2
Ethyl Benzene	C ₆ H ₅ -C ₂ H ₅	100%	-	-	o	+	+	o	-	-	o	+	1
Ethyl Benzoate	C ₆ H ₅ COOC ₂ H ₅	100%	n	-	+	o	+	+	-	-	+	+	1
Ethyl Bromide	C ₂ H ₅ Br	100%	-	n	+	+	n	+	-	o	+	+	2
Ethyl Chloroacetate	ClCH ₂ COOC ₂ H ₅	100%	-	o	+	+	+	+	-	-	+	+	2
Ethyl Chlorocarbonate	ClCO ₂ C ₂ H ₅	100%	n	n	n	n	n	+	-	n	n	n	(2)
Ethyl Cyclopentane	C ₅ H ₄ C ₂ H ₅	100%	+	+	+	+	+	+	-	-	+	+	(1)
Ethylacetoacetate	C ₆ H ₁₀ O ₃	100%	n	-	+	+	+	-	+/o	+/o	+	+	1
Ethylacrylic Acid	C ₄ H ₇ COOH	100%	n	n	+	+	+	n	+/o	n	+	+	(1)
Ethylene Diamine	(CH ₂ NH ₂) ₂	100%	o	o	+	-	o	-	+	n	+	o	2
Ethylene Dibromide => Dibromoethane													
Ethylene Dichloride => Dichloro Ethane													
Ethylene Glycol => Glycol													
Ethylenglycol Ethylether	HOC ₂ H ₄ OC ₂ H ₅	100%	n	n	+	+	+	n	+/o	o	+	+	1
Ethylhexanol	C ₈ H ₁₆ O	100%	n	+/o	+	+	+	+	+	-	+	+	2
Fatty Acids	R-COOH	100%	+	+	+	+	+	+	o	o	+	+	1
Ferric Chloride	FeCl ₃	s	+	+	+	+	-	+	+	+	+	+/o	1
Ferric Nitrate	Fe(NO ₃) ₃	s	+	+	+	+	+	+	+	+	+	+	1
Ferric Phosphate	FePO ₄	s	+	+	+	+	+	+	+	+	+	+	1
Ferric Sulphate	Fe ₂ (SO ₄) ₃	s	+	+	+	+	o	+	+	+	+	+	1



ProMinent® Chemical Resistance List

Chemical	Formula	Conc	PMMA	PVC	PP	PVDF	1.4404	FKM	EPDM	PharMed®	PE	2.4819	WPC
Ferrous Chloride	FeCl ₂	s	+	+	+	+	-	+	+	+	+	+/o	1
Ferrous Sulphate	FeSO ₄	s	+	+	+	+	+	+	+	+	+	+	1
Fixing Salt => Sodium Thiosulphate													
Fluoro Benzene	C ₆ H ₅ F	100%	-	-	+	+	+	o	-	-	o	+	2
Fluoroboric Acid	HF ₄	35%	+	+	+	+	o	+	+	-	+	+	1
Fluorosilicic Acid	H ₂ SiF ₆	100%	+	30%	30%	+	o	+	+	o	40%	+/o	2
Formaldehyde	CH ₂ O	40%	+	+	+	+	+	-	+/o	-	+	+	2
Formalin => Formaldehyde													
Formamide	HCONH ₂	100%	+	-	+	+	+	+	+	n	+	+	1
Formic Acid	HCOOH	s	-	+/o	+	+	+	-	-	+/o	+	+	1
Furane	C ₄ H ₄ O	100%	-	-	+	-	+	-	n	-	+	+	3
Furane Aldehyde	C ₅ H ₅ O ₂	100%	n	n	n	o	+	-	+/o	-	n	n	2
Furfuryl Alcohol	OC ₄ H ₃ CH ₂ OH	100%	-	-	+	o	+	n	+/o	-	+	+	1
Gallic Acid	C ₆ H ₂ (OH) ₃ COOH	5%	+	+	+	+	+	+	+/o	+	+	+	1
Gasoline		100%	-	-	+	+	+	+	-	-	+	+	2
Glauber´s Salt => Sodium Sulphate													
Glucose	C ₆ H ₁₂ O ₆	s	+	+	+	+	+	+	+	+	+	+	1
Glycerol	C ₃ H ₅ (OH) ₃	100%	+	+	+	+	+	+	+	+	+	+	1
Glycerol Triacetate	C ₃ H ₅ (CH ₃ COO) ₃	100%	n	n	+	+	+	-	+	n	+	+	1
Glycine	NH ₂ CH ₂ COOH	10%	+	+	+	+	+	+	+	+	+	+	1
Glycol	C ₂ H ₄ (OH) ₂	100%	+	+	+	+	+	+	+	+	+	+	1
Glycolic Acid	CH ₂ OHCOOH	70%	+	37%	+	+	+	+	+	+/o	+	+	1
Gypsum => Calcium Sulphate													
Heptane	C ₇ H ₁₆	100%	+	+	+	+	+	+	-	-	+	+	1
Hexachloroplatinic Acid	H ₂ PtCl ₆	s	n	+	+	+	-	n	+	n	+	-	
Hexanal	C ₅ H ₁₁ CHO	100%	n	n	+	+	+	-	+/o	-	+	+	1
Hexane	C ₆ H ₁₄	100%	+	+	+	+	+	+	-	-	+	+	1
Hexanol	C ₆ H ₁₃ OH	100%	-	-	+	+	+	n	+	o	+	+	1
Hexantriol	C ₆ H ₅ (OH) ₃	100%	n	n	+	+	+	+	+	n	+	+	1
Hexene	C ₆ H ₁₂	100%	n	+	+	+	+	+	-	-	+	+	1
Hydrazine Hydrate	N ₂ H ₄ * H ₂ O	s	+	+	+	+	+	n	+	o	+	+	3
Hydrobromic Acid	HBr	50%	+	+	+	+	-	-	+	-	+	o	1
Hydrochloric Acid	HCl	38%	32%	+	+	+	-	+	o	o	+	o	1
Hydrofluoric Acid	HF	80%	-	40%*	40%**	+	-	+	o	-	40%	+/o	1
Hydrogen Cyanide	HCN	s	+	+	+	+	+	+	+	+	+	+	3
Hydrogen Peroxide	H ₂ O ₂	90%	40%	40%*	30%	+	+	30%	30%	+	+	+	1
Hydroiodic Acid	HI	s	+	+	+	+	-	-	n	-	+	n	1
Hydroquinone	C ₆ H ₄ (OH) ₂	s	o	+	+	+	+	+	-	+/o	+	+	2
Hydroxylamine Sulphate	(NH ₂ OH) ₂ * H ₂ SO ₄	10%	+	+	+	+	+	+	+	+	+	+	2
Hypochlorous Acid	HOCl	s	+	+	o	+	-	+	+/o	+	o	+	(1)
Iodine	I ₂	s	o	-	+	+	-	+	+/o	+	o	+/o	
Iron Vitriol => Ferrous Sulphate													
Isobutanol => Isobutyl Alcohol													
Isobutyl Alcohol	C ₂ H ₅ CH(OH)CH ₃	100%	-	+	+	+	+	+	+	o	+	+	1
Isopropanol => Isopropyl Alcohol													
Isopropyl Acetate	CH ₃ COOCH(CH ₃) ₂	100%	-	-	+	+	+	-	+/o	+/o	+	+	1
Isopropyl Alcohol	(CH ₃) ₂ CHOH	100%	-	+/o	+	+	+	+	+	o	+	+	1
Isopropyl Benzene	C ₆ H ₅ CH(CH ₃) ₂	100%	-	-	o	+	+	+	-	-	o	+	1
Isopropyl Chloride	CH ₃ CHClCH ₃	80%	-	-	o	+	+	+	-	o	o	+/o	2
Isopropyl Ether	C ₆ H ₁₄ O	100%	-	-	o	+	+	-	-	o	o	+	1
Kitchen Salt => Sodium Chloride													
Lactic Acid	C ₃ H ₆ O ₃	100%	-	+	+	+	+/o	+	10%	+/o	+	+	1
Lead Acetate	Pb(CH ₃ COO) ₂	s	+	+	+	+	+	+	+	+	+	+	2
Lead Nitrate	Pb(NO ₃) ₂	50%	+	+	+	+	+	+	+	+	+	+	2
Lead Sugar => Lead Acetate													
Lead Sulphate	PbSO ₄	s	+	+	+	+	+	+	+	+	+	+	(2)
Lead Tetraethyl	Pb(C ₂ H ₅) ₄	100%	+	+	+	+	+	+	-	n	+	+	3
Lime Milk => Calcium Hydroxide													
Liquid Ammonia => Ammonium Hydroxide													
Lithium Bromide	LiBr	s	+	+	+	+	+	+	+	+	+	+	1
Lithium Chloride	LiCl	s	+	+	+	+	-	+	+	+	+	n	1
Lunar Caustic => Silver Nitrate													
Magnesium Carbonate	MgCO ₃	s	+	+	+	+	+	+	+	+	+	+/o	1
Magnesium Chloride	MgCl ₂	s	+	+	+	+	o	+	+	+	+	+	1
Magnesium Hydroxide	Mg(OH) ₂	s	+	+	+	+	+	+	+	+	+	+	1
Magnesium Nitrate	Mg(NO ₃) ₂	s	+	+	+	+	+	+	+	+	+	+	1
Magnesium Sulphate	MgSO ₄	s	+	+	+	+	+	+	+	+	+	+/o	1
Maleic Acid	C ₄ H ₄ O ₄	s	+	+	+	+	+	+	+	o	+	+	1
Malic Acid	C ₄ H ₆ O ₅	s	+	+	+	+	+	+	+	+	+	+	1



ProMinent® Chemical Resistance List

Chemical	Formula	Conc	PMMA	PVC	PP	PVDF	1.4404	FKM	EPDM	PharMed®	PE	2.4819	WPC
Manganese-II-Chloride	MnCl ₂	s	+	+	+	+	-	+	+	+	+	+	1
Manganese-II-Sulphate	MnSO ₄	s	+	+	+	+	+	+	+	+	+	+	1
MEK => Methyl Ethyl Ketone													
Mercury	Hg	100%	+	+	+	+	+	+	+	+	+	+	3
Mercury-II-Chloride	HgCl ₂	s	+	+	+	+	-	+	+	+	+	+	3
Mercury-II-Cyanide	Hg(CN) ₂	s	+	+	+	+	+	+	+	+	+	+	3
Mercury-II-Nitrate	Hg(NO ₃) ₂	s	+	+	+	+	+	+	+	+	+	+	3
Mesityl Oxide	C ₆ H ₁₀ O	100%	-	-	n	n	-	+/o	-	n	+	+	1
Methacrylic Acid	C ₃ H ₅ COOH	100%	n	n	+	+	o	+/o	+/o	+	+	+	1
Methanol	CH ₃ OH	100%	-	-	+	+	o	+	+/o	+	+	+	1
Methoxybutanol	CH ₃ O(CH ₂) ₄ OH	100%	-	-	+	+	+	o	o	+	+	+	(1)
Methyl Acetate	CH ₃ COOCH ₃	60%	-	-	+	+	+	-	+/o	+/o	+	+	2
Methyl Acrylate	C ₂ H ₃ COOCH ₃	100%	-	-	+	+	+	-	+/o	o	+	+	2
Methyl Benzoate	C ₆ H ₅ COOCH ₃	100%	-	-	+	o	+	+	-	-	+	+	2
Methyl Catechol	C ₆ H ₃ (OH) ₂ CH ₃	s	+	+	+	+	+	+	-	+o	+	+	(1)
Methyl Cellulose		s	+	+	+	+	+	+	+	+	+	+	1
Methyl Chloroacetate	ClCH ₂ COOCH ₃	100%	-	o	+	+	+	o	-	-	+	+	2
Methyl Cyclopentane	C ₅ H ₉ CH ₃	100%	+	+	+	+	+	+	-	-	+	+	(1)
Methyl Dichloroacetate	Cl ₂ CHCOOCH ₃	100%	-	-	+	n	+	-	n	-	+	+	2
Methyl Ethyl Ketone	CH ₃ COC ₂ H ₅	100%	-	-	+	-	+	-	+	-	+	+	1
Methyl Glycol	C ₃ H ₈ O ₂	100%	+	+	+	+	+	-	+/o	+	+	+	1
Methyl Isobutyl Ketone	CH ₃ COC ₄ H ₉	100%	-	-	+	-	+	-	o	-	+	+	1
Methyl Isopropyl Ketone	CH ₃ COC ₃ H ₇	100%	-	-	+	-	+	-	+/o	-	+	+	1
Methyl Methacrylate	C ₃ H ₅ COOCH ₃	100%	-	-	+	+	+	-	-	-	+	+	1
Methyl Oleate	C ₁₇ H ₃₃ COOCH ₃	100%	n	n	+	+	+	+	+/o	n	+	+	1
Methyl Salicylate	HO-C ₆ H ₄ -COOCH ₃	100%	-	-	+	+	+	n	+/o	-	+	+	1
Methylacetyl Acetate	C ₅ H ₈ O ₃	100%	-	-	+	+	+	-	+/o	o	+	+	2
Methylamine	CH ₃ NH ₂	32%	+	o	+	o	+	-	+	+	+	+	2
Methylene Chloride => Dichloro Methane													
Mirabilit => Sodium Sulphate													
Morpholine	C ₄ H ₉ ON	100%	-	-	+	-	+	n	n	-	+	+	2
Muriatic Acid => Hydrochloric Acid													
Natron => Sodium Bicarbonate													
Nickel-II-Acetate	(CH ₃ COO) ₂ Ni	s	+	+	+	+	+	-	+	+	+	+	(2)
Nickel-II-Chloride	NiCl ₂	s	+	+	+	+	-	+	+	+	+	+	2
Nickel-II-Nitrate	Ni(NO ₃) ₂	s	+	+	+	+	+	+	+	+	+	+/o	2
Nickel-II-Sulphate	NiSO ₄	s	+	+	+	+	+	+	+	+	+	+/o	2
Nitrate of Lime => Calcium Nitrate													
Nitric Acid	HNO ₃	99%	10%	10%*	50%	65%	50%	65%	10%	35%	50%	65%	1
Nitro Methane	CH ₃ NO ₂	100%	-	-	+	o	+	-	+/o	-	+	+	2
Nitro Propane	(CH ₃) ₂ CHNO ₂	100%	-	-	+	n	+	-	+/o	-	+	+	2
Nitro Toluene	C ₆ H ₄ NO ₂ CH ₃	100%	-	-	+	+	+	o	-	-	+	+	2
Octane	C ₈ H ₁₈	100%	o	+	+	+	+	+	-	-	+	+	1
Octanol	C ₈ H ₁₇ OH	100%	-	-	+	+	+	+	+	-	+	+	1
Octyl Cresol	C ₁₅ H ₂₄ O	100%	-	-	+	+	+	o	n	-	+	+	(1)
Oil => Engine Oils													
Oleum	H ₂ SO ₄ + SO ₃	s	n	-	-	-	+	+	-	+	-	+	2
Orthophosphoric Acid => Phosphoric Acid													
Oxalic Acid	(COOH) ₂	s	+	+	+	+	10%	+	+	+/o	+	+/o	1
Pentane	C ₅ H ₁₂	100%	+	+	+	+	+	+	-	-	+	+	1
Pentanol => Amyl Alcohol													
Perchloric Acid	HClO ₄	70%	n	10%	10%	+	-	+	+/o	+	+	n	1
Perchloroethylene => Tetrachloro Ethylene													
Perhydrol => Hydrogen Peroxide													
Petroleum Ether	C _n H _{2n+2}	100%	+	+/o	+	+	+	+	-	-	+	+	1
Phenole	C ₆ H ₅ OH	100%	-	-	+	+	+	+	-	+	+	+	2
Phenyl Ethyl Ether	C ₆ H ₅ OC ₂ H ₅	100%	-	-	+	n	+	-	-	-	+	+	2
Phenyl Hydrazine	C ₆ H ₅ NHNH ₂	100%	-	-	o	+	+	o	-	-	o	+	2
Phosphoric Acid	H ₃ PO ₄	85%	50%	+	+	+	+	+	+	+	+	+	1
Phosphorous Oxychloride	POCl ₃	100%	-	-	+	+	n	+	+	n	+	+	1
Phosphorous Trichloride	PCl ₃	100%	-	-	+	+	+	o	+	+/o	+	+	1
Phthalic Acid	C ₆ H ₄ (COOH) ₂	s	+	+	+	+	+	+	+	+	+	+	1
Picric Acid	C ₆ H ₂ (NO ₃) ₃ OH	s	+	+	+	+	+	+	+	-	+	+	2
Piperidine	C ₅ H ₁₁ N	100%	-	-	n	n	+	-	-	-	n	+	2
Potash Alum => Potassium Aluminium Sulphate													
Potassium Acetate	CH ₃ COOK	s	+	+	+	+	+	+	+	+	+	+	1
Potassium Aluminium Sulphate	KAl(SO ₄) ₂	s	+	+	+	+	+	+	+	+	+	+	1
Potassium Bicarbonate	KHCO ₃	40%	+	+	+	+	+	+	+	+	+	+/o	1
Potassium Bifluoride	KHF ₂	s	n	+	+	+	+	+	+	+	+	+	1



ProMinent® Chemical Resistance List

Chemical	Formula	Conc	PMMA	PVC	PP	PVDF	1.4404	FKM	EPDM	PharMed®	PE	2.4819	WPC
Potassium Bisulphate	KHSO ₄	5%	+	+	+	+	+	+	+	+	+	+	1
Potassium Bitartrate	KC ₄ H ₅ O ₆	s	+	+	+	+	+	+	+	+	+	+	1
Potassium Borate	KBO ₂	s	+	+	+	+	+	+	+	+	+	+	(1)
Potassium Bromate	KBrO ₃	s	+	+	+	+	+	+	+	+	+	+	2
Potassium Bromide	KBr	s	+	+	+	+	10%	+	+	+	+	0,1	1
Potassium Carbonate	K ₂ CO ₃	s	+	+	+	+	+	+	+	55%	+	+	1
Potassium Chlorate	KClO ₃	s	+	+	+	+	+	+	+	+	+	+	2
Potassium Chloride	KCl	s	+	+	+	+	-	+	+	+	+	+/o	1
Potassium Chromate	K ₂ CrO ₄	10%	+	+	+	+	+	+	+	+	+	+	3
Potassium Chrome Sulphate	KCr(SO ₄) ₂	s	+	+	+	+	+	+	+	+	+	+	1
Potassium Cyanate	KOCN	s	+	+	+	+	+	+	+	+	+	+	2
Potassium Cyanide	KCN	s	+	+	+	+	5%	+	+	+	+	5%	3
Potassium Cyanoferrate II	K ₄ Fe(CN) ₆	s	+	+	+	+	+	+	+	+	+	+	1
Potassium Cyanoferrate III	K ₃ Fe(CN) ₆	s	+	+	+	+	+	+	+	+	+	+	1
Potassium Dichromate	K ₂ Cr ₂ O ₇	s	+	+	+	+	25%	+	+	+	+	10%	3
Potassium Fluoride	KF	s	+	+	+	+	+	+	+	+	+	+	1
Potassium Hydroxyde	KOH	50%	+	+	+	+	(25 °C)	+	-	+	10%	+	1
Potassium Iodide	KI	s	+	+	+	+	+	+	+	+	+	+	1
Potassium Nitrate	KNO ₃	s	+	+	+	+	+	+	+	+	+	+	1
Potassium Perchlorate	KClO ₄	s	+	+	+	+	n	+	+	+	+	+	1
Potassium Permanganate	KMnO ₄	s	+	+	+	+	+	+	+	6%	+	+	2
Potassium Persulphate	K ₂ S ₂ O ₈	s	+	+	+	+	+	+	+	+	+	+	1
Potassium Phosphate	KH ₂ PO ₄	s	+	+	+	+	+	+	+	+	+	+	1
Potassium Pyrochromate => Potassium Dichromate													
Potassium Sulphate	K ₂ SO ₄	s	+	+	+	+	+	+	+	+	+	+	1
Potassium Sulphite	K ₂ SO ₃	s	+	+	+	+	+	+	+	+	+	+	1
Propionic Acid	C ₂ H ₅ COOH	100%	o	+	+	+	+	+	+	+/o	+	+	1
Propionitrile	CH ₃ CH ₂ CN	100%	n	n	+	+	+	+	-	-	+	+	2
Propyl Acetate	CH ₃ COOC ₃ H ₇	100%	-	-	+	+	+	-	+/o	-	+	+	1
Propylene Glycol	CH ₃ CHOHCH ₂ OH	100%	+	+	+	+	+	+	+	+	+	+	1
Prussic Acid => Hydrogen Cyanide													
Pyridine	C ₅ H ₅ N	100%	-	-	o	-	+	-	-	o	+	+	2
Pyrrole	C ₄ H ₄ NH	100%	n	n	+	n	+	-	-	-	+	+	2
Roman Vitriol => Copper Sulphate													
Salicylic Acid	HOC ₆ H ₄ COOH	s	+	+	+	+	+	+	+	+	+	+/o	1
Salmiac => Ammonium Chloride													
Saltpeter => Potassium Nitrate													
Silic Acid	SiO ₂ * x H ₂ O	s	+	+	+	+	+	+	+	+	+	+	1
Silver Bromide	AgBr	s	+	+	+	+	+/o	+	+	+	+	+	1
Silver Chloride	AgCl	s	+	+	+	+	-	+	+	+	+	+/o	1
Silver Nitrate	AgNO ₃	s	+	+	+	+	+	+	+	+	+	+/o	3
Slaked Lime => Calcium Hydroxide													
Soda => Sodium Carbonate													
Sodium Acetate	NaCH ₃ COO	s	+	+	+	+	+	+	+	+	+	+	1
Sodium Benzoate	C ₆ H ₅ COONa	s	+	+	+	+	+	+	+	+	+	+	1
Sodium Bicarbonate	NaHCO ₃	s	+	+	+	+	+	+	+	+	+	+	1
Sodium Bisulphate	NaHSO ₄	s	+	+	+	+	+	+	+	+	+	+	1
Sodium Bisulphite	NaHSO ₃	s	+	+	+	+	+	+	+	+	+	+	1
Sodium Borate	NaBO ₂	s	+	+	+	+	+	+	+	+	+	+	1
Sodium Bromate	NaBrO ₃	s	+	+	+	+	+	+	+	+	+	+	3
Sodium Bromide	NaBr	s	+	+	+	+	+	+	+	+	+	+	1
Sodium Carbonate	Na ₂ CO ₃	s	+	+	+	+	+/o	+	+	+	+	+	1
Sodium Chlorate	NaClO ₃	s	+	+	+	+	+	+	+	+	+	+	2
Sodium Chloride	NaCl	s	+	+	+	+	-	+	+	+	+	+	1
Sodium Chlorite	NaClO ₂	24%	+	+	+	+	10%	+	+	+	+	10%	2
Sodium Chromate	Na ₂ CrO ₄	s	+	+	+	+	+	+	+	+	+	+	3
Sodium Cyanide	NaCN	s	+	+	+	+	+	+	+	+	+	+	3
Sodium Dichromate	Na ₂ Cr ₂ O ₇	s	+	+	+	+	+	+	+	+	+	+	3
Sodium Dithionite	Na ₂ S ₂ O ₄	s	+	10%	10%	+	+	n	n	+	10%	+/o	1
Sodium Fluoride	NaF	s	+	+	+	+	10%	+	+	+	+	+	1
Sodium Hydrogen Sulphate => Sodium Bisulphate													
Sodium Hydroxide	NaOH	50%	+	+	+	+	(60% / 25 °C)	+	-	+	30%	+	1
Sodium Hypochlorite	NaOCl + NaCl	12%	+	+	o	+	-	+	+	+	o	> 10%	2
Sodium Iodide	NaI	s	+	+	+	+	+	+	+	+	+	+	1
Sodium Metaphosphate	(NaPO ₃) _n	s	+	+	+	+	+	+	+	+	+	+	1
Sodium Nitrate	NaNO ₃	s	+	+	+	+	+	+	+	+	+	+	1
Sodium Nitrite	NaNO ₂	s	+	+	+	+	+	+	+	+	+	+	2
Sodium Oxalate	Na ₂ C ₂ O ₄	s	+	+	+	+	+	+	+	+	+	+	1



ProMinent® Chemical Resistance List

Chemical	Formula	Conc	PMMA	PVC	PP	PVDF	1.4404	FKM	EPDM	PharMed®	PE	2.4819	WPC
Sodium Perborate	NaBO ₂ *H ₂ O ₂	s	+	+/o	+	+	+	+	+	+	+	+/o	1
Sodium Perchlorate	NaClO ₄	s	+	+	+	+	10%	+	+	+	+	10%	1
Sodium Peroxide	Na ₂ O ₂	s	+	+	+	+	+	+	+	n	-	+	1
Sodium Persulphate	Na ₂ S ₂ O ₈	s	n	+	+	+	+	+	+	+	+	+	1
Sodium Pyrosulphite	Na ₂ S ₂ O ₅	s	+	+	+	+	+	n	n	+	+	+	1
Sodium Salicylate	C ₆ H ₄ (OH)COONa	s	+	+/o	+	+	+	+	+	+	+	+	1
Sodium Silicate	Na ₂ SiO ₃	s	+	+	+	+	+	+	+	+	+	+	1
Sodium Sulphate	Na ₂ SO ₄	s	+	+	+	+	+	+	+	+	+	+	1
Sodium Sulphide	Na ₂ S	s	+	+	+	+	+	+	+	+	+	+	2
Sodium Sulphite	Na ₂ SO ₃	s	+	+	+	+	50%	+	+	+	+	50%	1
Sodium Tetraborate	Na ₂ B ₄ O ₇ * 10 H ₂ O	s	+	+	+	+	+	+	+	+	+	+	1
Sodium Thiosulphate	Na ₂ S ₂ O ₃	s	+	+	+	+	25%	+	+	+	+	25%	1
Sodium Tripolyphosphate	Na ₅ P ₃ O ₁₀	s	+	+	+	+	+	+/o	+	+	+	+	1
Starch	(C ₆ H ₁₀ O ₅) _n	s	+	+	+	+	+	+	n	+	+	+	1
Starch Gum		s	+	+	+	+	+	+	+	+	+	+	1
Styrene	C ₆ H ₅ CHCH ₂	100%	-	-	o	+	+	o	-	-	o	+	2
Sublimate => Mercury-II-Chloride													
Succinic Acid	C ₄ H ₆ O ₄	s	+	+	+	+	+	+	+	+	+	+	1
Sugar Syrup		s	+	+	+	+	+	+	+	+	+	+	1
Sulphur Chloride => Disulphur Dichloride													
Sulphuric Acid	H ₂ SO ₄	98%	30%	50%	85%	+	20%	+	+	30%	80%	+	1
Sulphuric Acid, fuming --> Oleum													
Sulphurous Acid	H ₂ SO ₃	s	+	+	+	+	10%	+	+	+	+	+	(1)
Sulphuryl Chloride	SO ₂ Cl ₂	100%	-	-	-	o	n	+	o	-	-	n	1
Tannic Acid	C ₇₆ H ₅₂ O ₄₆	50%	+	+	+	+	+	+	+	+	+	+	1
Tartaric Acid	C ₄ H ₆ O ₆	s	50%	+	+	+	+	+	+/o	+	+	+	1
Tetrachloro Ethane	C ₂ H ₂ Cl ₄	100%	-	-	o	+	+	o	-	o	o	+	3
Tetrachloro Ethylene	C ₂ Cl ₄	100%	-	-	o	+	+	o	-	o	o	+	3
Tetrachloromethane => Carbon Tetrachloride													
Tetrahydro Furane	C ₄ H ₈ O	100%	-	-	o	-	+	-	-	-	o	+	1
Tetrahydro Naphthalene	C ₁₀ H ₁₂	100%	-	-	-	+	+	+	-	-	o	+	3
Tetralin => Tetrahydro Naphthalene													
THF => Tetrahydrofurane													
Thionyl Chloride	SOCl ₂	100%	-	-	-	+	n	+	+	+	-	n	1
Thiophene	C ₄ H ₄ S	100%	n	-	o	n	+	-	-	-	o	+	3
Tin-II-Chloride	SnCl ₂	s	+	o	+	+	-	+	+	+	+	+/o	1
Tin-II-Sulphate	SnSO ₄	s	n	+	+	+	+	+	+	+	+	+/o	(1)
Tin-IV-Chloride	SnCl ₄	s	n	+	+	+	-	+	+	+	+	+	1
Titanium Tetrachloride	TiCl ₄	100%	n	n	n	+	n	o	-	n	n	n	1
Toluene	C ₆ H ₅ CH ₃	100%	-	-	o	+	+	o	-	-	o	+	2
Toluene Diisocyanate	C ₇ H ₃ (NCO) ₂	100%	n	n	+	+	+	-	+/o	n	+	+	2
Tributyl Phosphate	(C ₄ H ₉) ₃ PO ₄	100%	n	-	+	+	+	-	+	+	+	+	1
Trichloro Ethane	CCl ₃ CH ₃	100%	-	-	o	+	+	+	-	o	o	+	3
Trichloro Ethylene	C ₂ HCl ₃	100%	-	-	o	+	+/o	o	-	o	o	+	3
Trichloro Methane => Chloroform													
Trichloroacetaldehyde Hydrate	CCl ₃ CH(OH) ₂	s	-	-	o	-	+	o	o	n	+	+	2
Trichloroacetic Acid	CCl ₃ COOH	50%	-	+	+	+	-	-	o	+/o	+	+	1
Tricresyl Phosphate	(C ₇ H ₇) ₃ PO ₄	90%	-	-	+	n	+	o	+	+	+	+	2
Triethanol Amine	N(C ₂ H ₄ OH) ₃	100%	+	o	+	n	+	-	+/o	o	+	+	1
Trilene => Trichloro Ethane													
Trioctyl Phosphate	(C ₈ H ₁₇) ₃ PO ₄	100%	n	-	+	+	+	o	+	+	+	+	2
Trisodium Phosphate	Na ₃ PO ₄	s	+	+	+	+	+	+	+	+	+	+	1
Urea	CO(NH ₂) ₂	s	+	+/o	+	+	+	+	+	20%	+	+	1
Vinyl Acetate	CH ₂ =CHOOCCCH ₃	100%	-	-	+	+	+	n	n	+/o	+	+	2
Water Glass => Sodium Silicate													
Xylene	C ₆ H ₄ (CH ₃) ₂	100%	-	-	-	+	+	o	-	-	o	+	2
Zinc Acetate	(CH ₃ COO) ₂ Zn	s	+	+	+	+	+	-	+	+	+	+	1
Zinc Chloride	ZnCl ₂	s	+	+	+	+	-	+	+	+	+	n	1
Zinc Sulphate	ZnSO ₄	s	+	+	+	+	n	+	+	+	+	+/o	1

1) Chlorine dioxide is capable of penetrating through PVDF without destroying it. This can lead to damage to PVDF-coated parts.



ProMinent® Chemical Resistance List

Overview of the Resistance of Soft PVC Hoses (Guttasyn®) to the Most Common Chemicals

This data applies to standard conditions (20 °C, 1013 mbar).

+	=	resistant
o	=	conditionally resistant
-	=	not resistant

The data is taken from relevant manufacturers' literature and supplemented by our own tests and experience. As the resistance of a material also depends on other factors, especially pressure and operating conditions etc, this list should merely be regarded as an initial guide and does not claim to offer any guarantees. Take into consideration the fact that conventional dosing agents are largely compounds, the corrosiveness of which cannot simply be calculated by adding together the corrosiveness of each individual component. In cases such as these the material compatibility data produced by the chemical manufacturer must be read as a matter of priority when selecting a material. Safety data sheets do not provide this information and cannot therefore replace application-specific documentation.

Corrosive agent	Concentration in %	Evaluation
Acetone	all	-
Acetylene tetrabromide	100	-
Alums of all kinds, aqueous	all	+
Aluminium salts, aqueous	all	+
Ammonium, aqueous	15	-
Ammonium, aqueous	saturated	-
Ammonium salts	all	+
Aniline	100	-
Benzene	100	-
Bisulphite, aqueous	40	+
Borax solution	all	+
Boric acid, aqueous	10	+
Bromine, vaporous and liquid		-
Hydrogen bromide	10	+
Butanol	100	+
Butyric acid, aqueous	20	+
Butyric acid, aqueous	conc.	-
Butyl acetate	100	-
Calcium chloride, aqueous	all	+
Chlorinated hydrocarbons	all	-
Chrome-alum, aqueous	all	+
Chromic acid, aqueous	50	-
Dextrin, aqueous	saturated	+
Diesel oils, compressed oils	100	o
Diethyl ether	100	-
Fertilizing manure salt, aqueous	all	+
Ferric chloride, aqueous	all	+
Glacial acetic acid	100	-
Acetic ester	100	-
Acetic acid, aqueous	10	+
Acetic acid	50	o
Acetic acid (wine vinegar)		o
Acetic acid anhydride	100	-
Ethanol	96	-
Ethyl acetate	100	-
Ethylene glycol	30	+
Formaldehyde, aqueous	30	o
Difluorodichloromethane	100	-
Glycerol	100	-
Glucose, aqueous	saturated	+
Halogens	all	-
Urea, aqueous	all	+
Caustic potash	15	+
Potassium bichromate, aqueous	saturated	+
Potassium persulphate, aqueous	saturated	+



ProMinent® Chemical Resistance List

Corrosive agent	Concentration in %	Evaluation
Creosote		-
Sodium chloride, aqueous	all	+
Carbonic acid	all	+
Copper sulphate, aqueous	all	+
Magnesium salts, aqueous	all	+
Methyl alcohol	100	+
Methylene chloride	100	-
Sodium hypochlorite	15	+
Sodium salts => sodium chloride		
Sodium hydroxide	aqueous	+
Oils => fats, diesel oil, Lubricating oil and similar		
Perchloric acid	all	o
Phenol, aqueous	all	o
Phosphoric acid, aqueous	100	-
Nitric acid, aqueous	25	+
Hydrochloric acid	15	+
Sulphur dioxide, gaseous	all	+
Carbon disulphide	100	-
Sulphuric acid	30	+
Hydrogen sulphide, gaseous	100	-
Silver nitrate	10	+
Tetrachloromethane	100	-
Ink		+
Toluene	100	-
Trichloroethylene	100	-
Hydrogen peroxide	to 10	+
Xylene	100	-
Zinc salts	all	+



Product catalogue 2018

Order your personal copy.
How you want it, when you want it.

Groundbreaking diversity: ProMinent 2018.

Our product catalogue is available in four individual volumes. We are offering you the following options so that you can request your catalogue of choice.



Metering pumps, components
and metering systems



Motor-driven and process metering
pumps for all capacity ranges



Measuring, control and
sensor technology



Water treatment and
water disinfection

You can find the ProMinent app for iPads in the iTunes App Store.
www.prominent.com/app



You can find our individual catalogue volumes for download or online browsing at
www.prominent.com/en/product-catalogue
Or request your own printed copy directly from us at
www.prominent.com/en/catalogue-request

Do you need an overview of our entire product range?
Then we would recommend our product overview.
www.prominent.com/en/productoverview