

Pliers and Pliers/Cutters

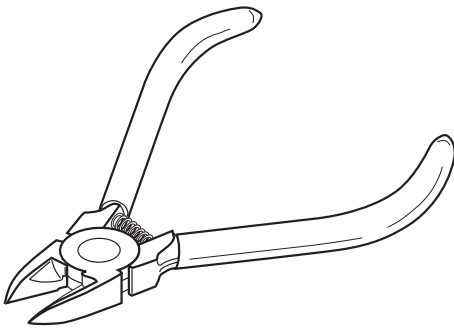

993-500

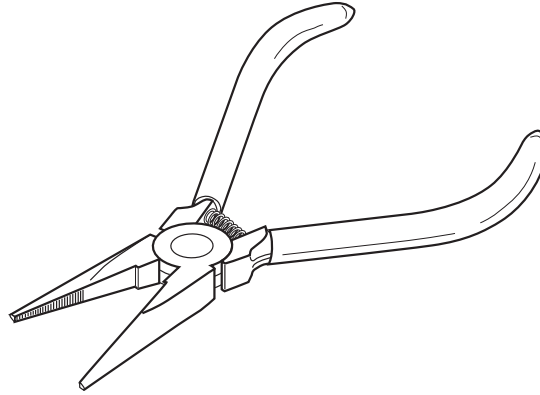

993-510

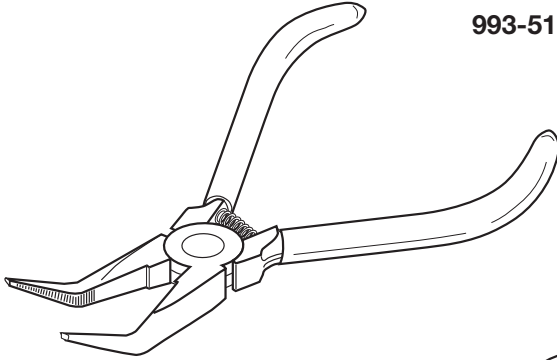

993-520

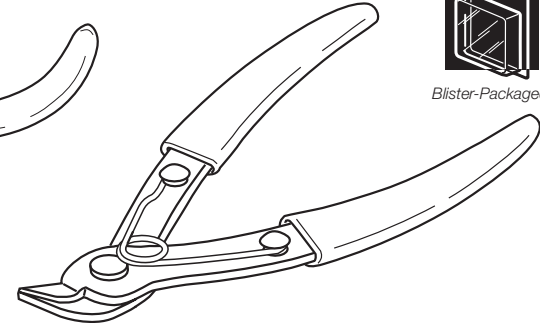

993-620

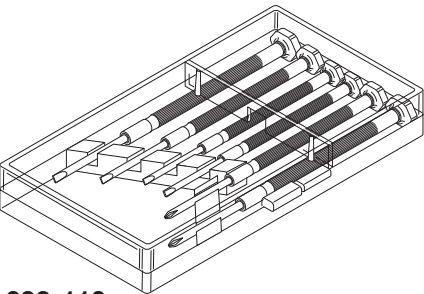

993-110

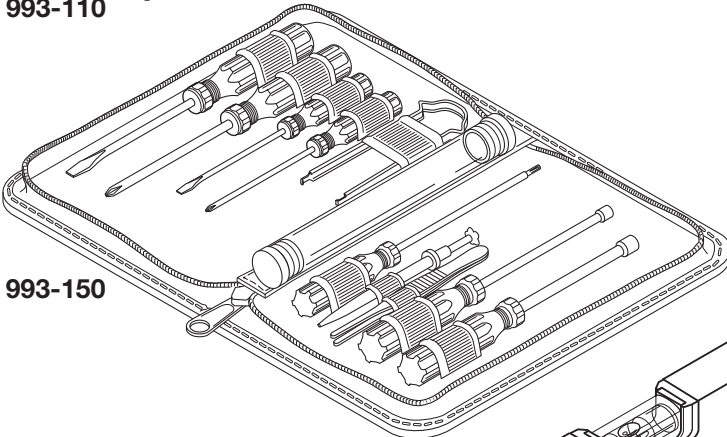

993-150



Hardened Steel Construction – Spring Loaded
Soft Cushion-Grip Insulated Handles

993-500 4 1/2" Mini Diagonal Cutting Pliers

993-510 5" Miniature Long Nose Pliers
Serrated Jaws with Side Cutter

993-520 5" Miniature Bent Nose Pliers
Serrated Jaws with Side Cutter

993-620 5" Miniature Precision Flush Cutter
Display Packaged for Resale

Screwdriver Sets

993-110 6-Piece Jewelers Screwdriver Set
4 Slotted 1.4, 2.0, 2.4, 2.9mm
2 Phillips #0, #1 Screwdrivers
Swivel-Top Knurled Handle
Clear Plastic Storage Case

993-150 11-Piece Computer Service Kit
Spare Parts Holder
Assembly Tweezers
Three Claw Component Holder
IC Extraction Tool
2 Slotted Screwdrivers 1/8", 3/16"
2 Phillips Screwdrivers #0, #1
2 Nutdrivers 3/16", 1/4"
1 Torx Screwdriver
9"x6" Zippered Vinyl Case

Laser Levels

Professional Leveling Tool
Horizontal/Vertical Liquid Level
Convenient Ruler in Both Metric, English Units
Sliding cover selects line or dot projection
Projects at a distance of 1500'
Durable Yellow Aluminum Frame
Black PVC End Caps
Non-Scratch Machined Bottom Surface
1/4" Threaded Tripod Mounting Hole
Compliant with FDA Standards
Includes 2 AAA batteries
Display Packaged for Resale

NEW ▶ 203-606 16" Laser Level

NEW ▶ 203-608 48" Laser Level

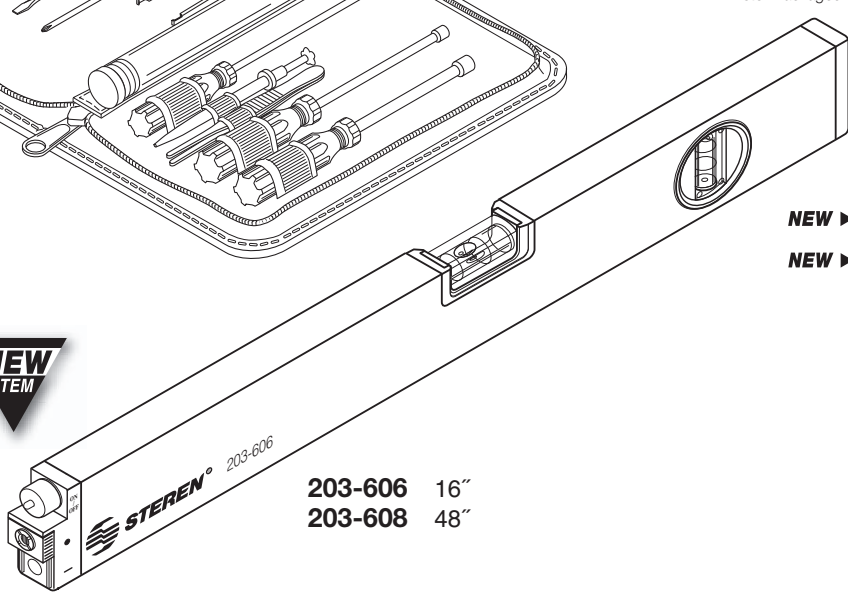

203-606 16"

203-608 48"