

Solderless Breadboards

ABS Polymer Insulator – 1/10" Tie-Point Grid
 AWG19-29 Nickel Phosphor-Bronze Contacts
 Contact Resistance 1mΩ at 1kHz
 Slide Molded Dovetail Lock
 Silkscreened Alphanumeric Grid Index with
 Red and Blue Polarity Strips
 Display Packaged for Resale

509-005 400 Tie-Point Breadboard
 2 Distribution Strips
 1 Terminal Strip
 3 3/8" (L) x 2 5/8" (W) x 3/8" (H)

509-007 750 Tie-Point Breadboard
 3 Distribution Strips
 2 Terminal Strips
 3 3/8" (L) x 4 5/8" (W) x 3/8" (H)

509-010 840 Tie-Point Breadboard
 2 Distribution Strips
 1 Terminal Strip
 6 7/8" (L) x 2 5/8" (W) x 3/8" (H)

509-020 840 Tie-Point Breadboard
 2 Distribution Strips
 1 Terminal Strip – 3 Binding Posts
 6 7/8" (L) x 2 5/8" (W) x 3/8" (H)

509-030 1680 Tie-Point Breadboard
 4 Distribution Strips
 2 Terminal Strip – 3 Binding Posts
 6 7/8" (L) x 5 1/8" (W) x 3/8" (H)

509-040 2420 Tie-Point Breadboard
 5 Distribution Strips
 3 Terminal Strip – 4 Binding Posts
 7 3/8" (L) x 6 7/8" (W) x 3/8" (H)

509-050 3260 Tie-Point Breadboard
 7 Distribution Strips
 4 Terminal Strip – 4 Binding Posts
 7 7/8" (L) x 8 3/4" (W) x 3/8" (H)

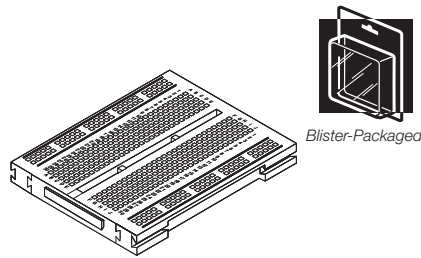

509-005 400 Tie-Point



Blister-Packaged

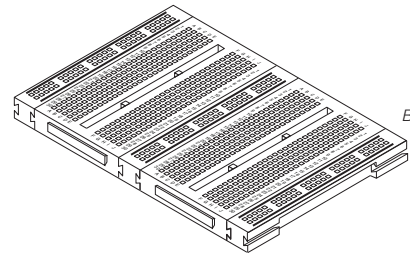

509-007 750 Tie-Point



Blister-Packaged



Blister-Packaged

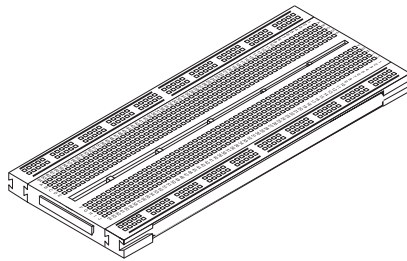

509-010 840 Tie-Point



Blister-Packaged

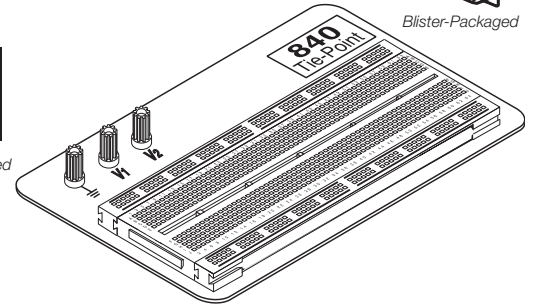

509-020 840 Tie-Point



Blister-Packaged

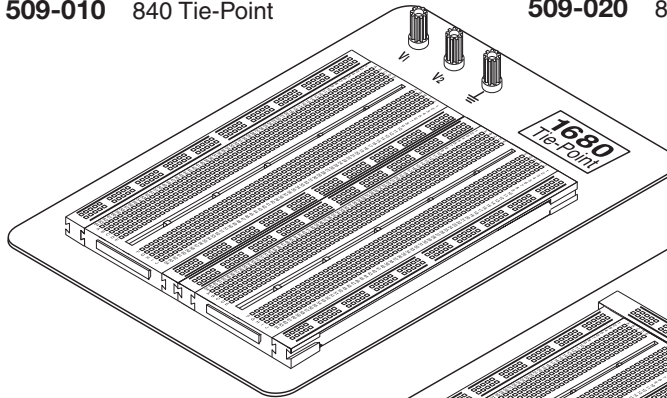

509-030 1680 Tie-Point



Blister-Packaged

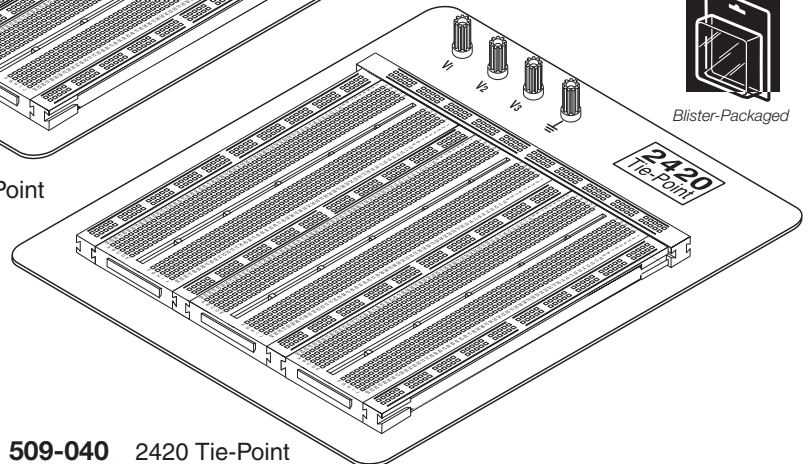

509-040 2420 Tie-Point



Blister-Packaged

Jumper Wire Kit

509-100 Breadboard Jumper Wire Kit
 AWG22 Insulated Solid Wire
 Pre-stripped Lengths – 10pcs/color
 Brown, Red, Orange, Yellow, Green,
 Blue, Violet, Grey, White

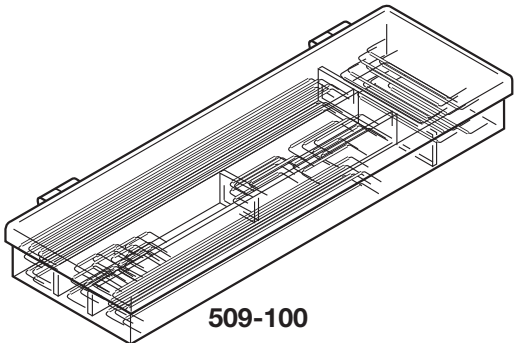

509-100



Blister-Packaged

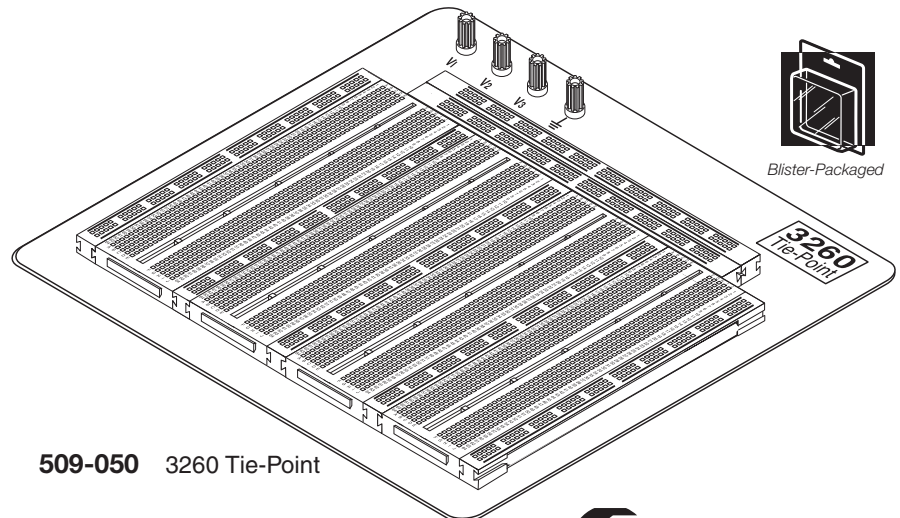

509-050 3260 Tie-Point