

DIN Connectors

Nickel-Plated Contacts – Solder Terminals
Black Plastic Housing with Strain Relief

- 250-205** 5-Contact DIN Plug 180°
- 250-220** 8-Contact DIN Plug
- 250-585** 5-Contact DIN Jack 180°
- 250-586** 5-Contact DIN Jack Panel 180°
- 250-592** 8-Contact DIN Jack

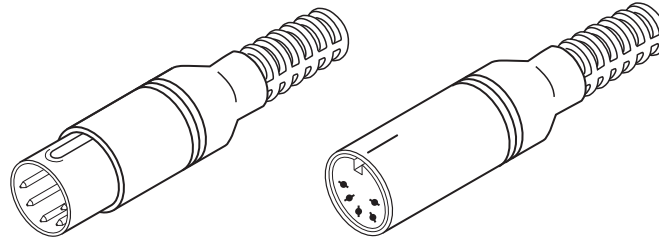

250-205 5-Pin 180°
250-220 8-Pin

250-585 5-Pin 180°
250-592 8-Pin

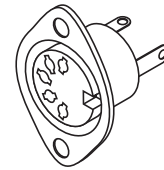

250-586 5-Pin 180°

Mini-DIN Connectors

Nickel-Plated Contacts – Solder Terminals
Black Plastic Housing with Strain Relief

- 250-234** 4-Pin Plug – S-Video Connector
- 250-235** 6-Pin Plug – Keyboard Connector
- 250-236** 8-Pin Plug – Apple Macintosh
- 250-238** 4-Pin Jack – S-Video Connector
- 250-239** 6-Pin Jack – Keyboard Connector
- 250-240** 8-Pin Jack – Apple Macintosh

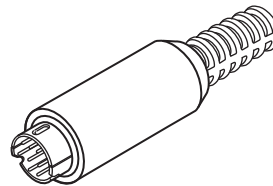

250-234 4-Pin
250-235 6-Pin
250-236 8-Pin

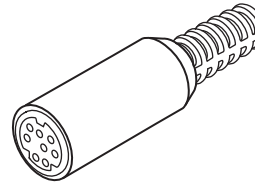

250-238 4-Pin
250-239 6-Pin
250-240 8-Pin

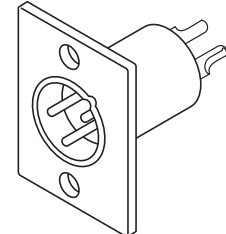

250-700

Microphone Connectors

- 250-700** 3C XLR Plug Panel Mount
- 250-705** 3C XLR Jack Panel Mount
- 250-710** 3C XLR Plug with Strain Relief
- 250-720** 3C XLR Jack with Strain Relief
- 250-790** 4C Microphone Connector

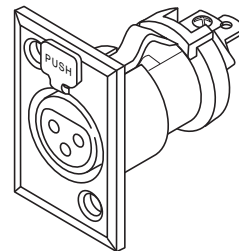

250-705

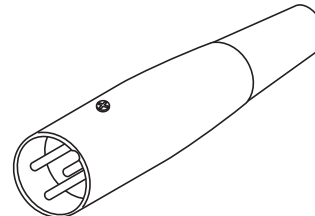

250-710

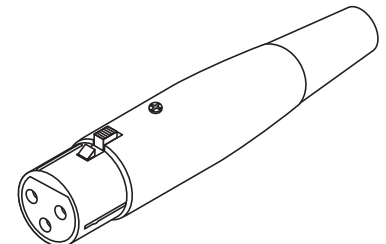

250-720

Car-Antenna Connector

- 250-302** Motorola Car-Antenna Plug

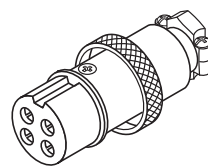

250-790

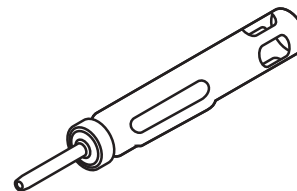

250-302

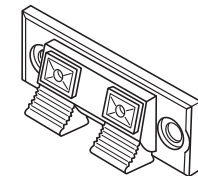

250-582

Speaker Terminals

- 250-582** 2⁵/₁₆" x 7⁷/₈" Terminal Connector
- 250-583** 2" Round Cup Terminal Connector
- 250-584** 3³/₄" x 3" Square Cup Terminal

Speaker Cable Connectors

Crimp-On High-Conductivity Gold-Plated Pins
Precision Machined – Soft PVC Cover Suitable for 9-16 Gauge Speaker Cable

- 250-800BK** Speaker Pin Connector – Black
- 250-800RD** Speaker Pin Connector – Red

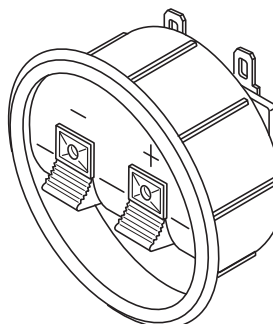

250-583

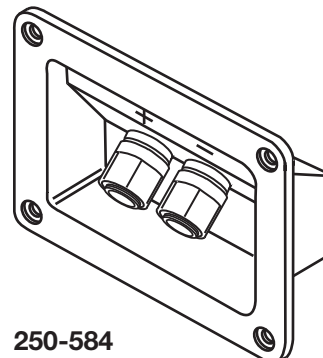

250-584

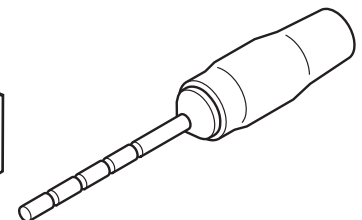

250-800BK Black
250-800RD Red