

20 3/4" Bullnose Beads

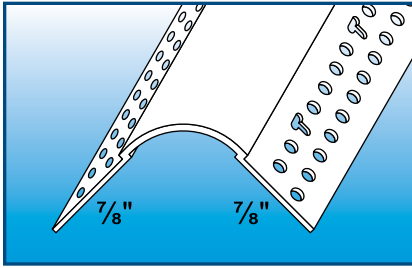

3/4" R. BULLNOSE CORNER BEAD

- Softens corners & adds a contemporary look
- Trim-Tex offers the most complete line of 3/4" Bullnose products in the industry.

Stock No.	LENGTH	Pcs. PER BOX
7008	8'	35
7009	9'	35
7010	10'	35
7012	12'	35

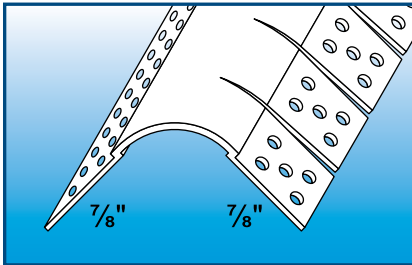

3/4" R. BULLNOSE ARCHWAY BEAD

- Notched to conform to archways and curves
- Goes from a 15" inside to a 20" outside radius
- Finish in half the time with our 3/4" R. Archway Bullnose Finishing Tool. See page 29.

Stock No.	LENGTH	Pcs. PER BOX
7108	8'	35
7110	10'	35

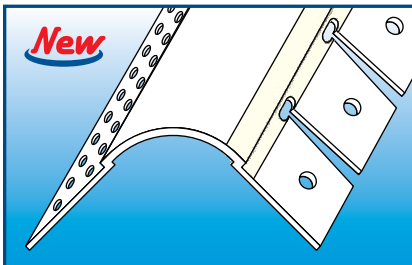

3/4" R. BULLNOSE NO NOTCH SPRUNG ARCH

- The No Notch Sprung Arch is designed to finish Sprung Arches and is recommended for doors 5' and wider.
- This patented product eliminates filling notches on the exposed surface of the bullnose.
- Perfectly matches the entire 3/4" R. Bullnose product line.

Stock No.	LENGTH	Pcs. PER BOX
7120	10'	35

U.S. PATENT #6,119,420

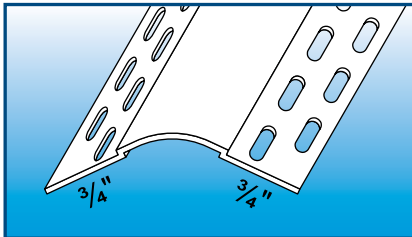

3/4" R. BULLNOSE SPLAYED CORNER BEAD

- Designed to fit off angle outside corners commonly called 45° or 135° corners.

Stock No.	LENGTH	Pcs. PER BOX
7308	8'	35
7309	9'	35
7310	10'	35

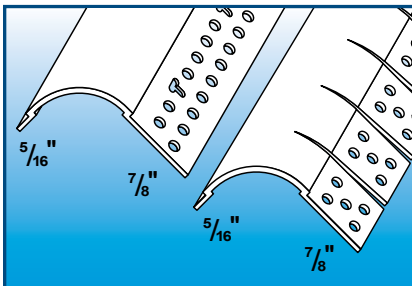

3/4" R. BULLNOSE TRADITIONAL STYLE KERFED BEAD

- 5/16" leg can be inserted into the channel of many preformed door and window jambs
- Creates attractive rounded encasement

Stock No.	LENGTH	Pcs. PER BOX
7088T	8'	35
7080T	10'	35

3/4" R. BULLNOSE TRADITIONAL STYLE KERFED ARCH BEAD

- Slotted to conform to most arched openings
- From a 15" inside to a 20" outside radius

Stock No.	LENGTH	Pcs. PER BOX
7188T	8'	35
7180T	10'	35

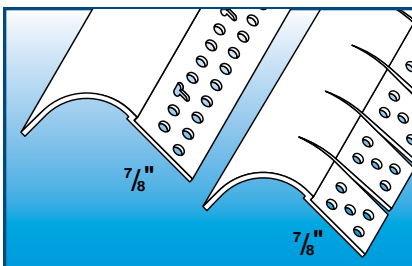

3/4" R. BULLNOSE KERFED BEAD

- Leg can be inserted into the channel of many preformed door and window jambs
- Creates attractive rounded encasement

Stock No.	LENGTH	Pcs. PER BOX
7088	8'	35
7080	10'	35

3/4" R. BULLNOSE KERFED ARCH BEAD

- Slotted to conform to most arched openings
- From a 15" inside to a 20" outside radius

Stock No.	LENGTH	Pcs. PER BOX
7188	8'	35
7180	10'	35

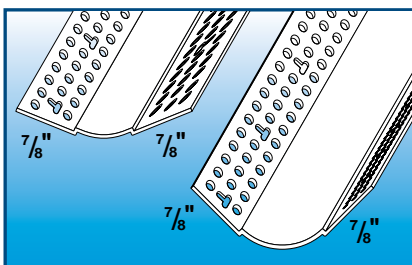

INSIDE SPLAYED 3/4" R. BULLNOSE CORNER BEAD

- Designed to finish inside off angle corners

Stock No.	LENGTH	Pcs. PER BOX
7250	10'	35

3/4" R. BULLNOSE INSIDE CORNER BEAD

- Designed to finish inside 90° corners.

Stock No.	LENGTH	Pcs. PER BOX
7208	8'	35
7210	10'	35

BULL-RAIL STYLE 672

- Bull-Rail is a decorative trim designed to be applied to the surface of the drywall.
- Can be used horizontally, vertically, or at any angle to create a bullnose accent.
- The finished Bull-Rail is 1" across and extends 1/2".

STOCK No.	LENGTH	Pcs. PER BOX
67210M	10'	8
67210	10'	20

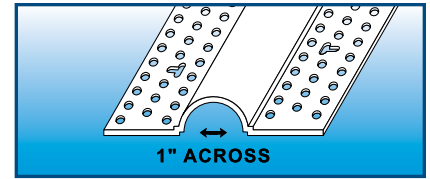

3/4" RADIUS J ROUND

- Available in the two most popular sizes, J Round is designed to be installed after the drywall. There is no need to wrap the bead behind the drywall. It's great for finishing window and door openings and for finishing drywall buildouts.

STOCK No.	SIZE	LGTH	Pcs. PER BOX
7408	1/2"	8'	30
7410M	1/2"	10'	10
7410	1/2"	10'	30
7508	5/8"	8'	30
7510M	5/8"	10'	10
7510	5/8"	10'	30

3/4" R. BULLNOSE J ROUND INSIDE AND OUTSIDE CORNERS

- Inside and Outside Corners match 2 Bullnose J Rounds joined at 90° inside or outside angles

STOCK No.	SIZE	Pcs. PER BOX
0906M	1/2"	10
0906	1/2"	50
0907M	5/8"	10
0907	5/8"	50
0918M	1/2"	10
0918	1/2"	50
0919M	5/8"	10
0919	5/8"	50

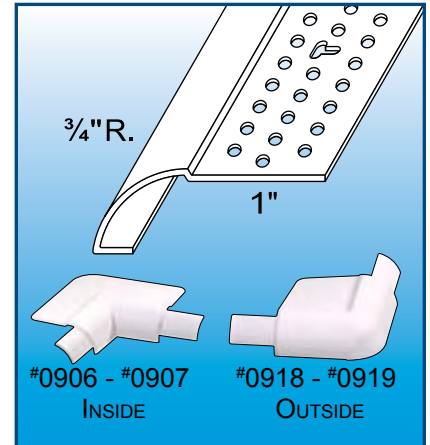

3/4" R. BULLNOSE SPLICER

- Designed to join 2 sections of a 3/4" R. Bullnose Corner Bead
- Works for joining straight and archway bullnose
- Unique spring action allows Splicer to be snapped into the bead, making for perfect alignment
- Use with Trim-Tex #710 Adhesive Caulk to eliminate cracking

STOCK No.	Pcs. PER BOX
0925M	10
0925	100

U.S. PATENT #5,813,179

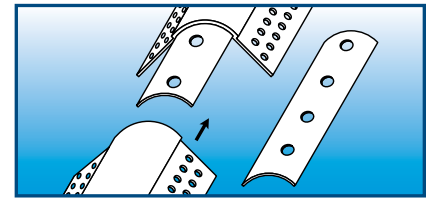

3/4" & 1 1/2" BULLNOSE MITER MARKER

- This high quality tool includes miter marking for 90° and 135° off angle inside corners as well as alignment marks that eliminate the guesswork when finishing door and window openings. The tool works on all 3/4" & 1 1/2" Bullnose products, including Bullnose Corner Bead, Bullnose Super & Giant L Beads and Bullnose Fast Cap. *Note: 1 1/2" Miter Marker Tool only includes marking for 90° corners.

STOCK No.	SIZE	Pcs. PER BOX
0932M	3/4"	10
0932	3/4"	40
0933	1 1/2"	5

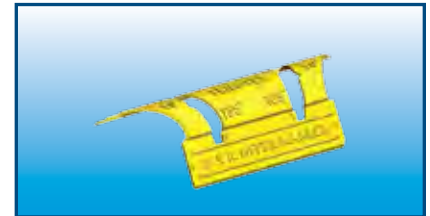

WOOD BULLNOSE CORNER BLOCKS By MIDWESTERN WOOD PRODUCTS

- To complement 3/4" Bullnose applications, Trim-Tex now stocks poplar stand-alone blocks designed to finish bullnose corners. Deluxe style can accommodate baseboard up to 5 3/8" tall and 13/16" thick. Standard style can accommodate up to 3 11/16" tall and 9/16" thick. Bullnose corner blocks come in special sizes and wood species including Red Oak, as well as baseboards, bullnose crowns and other beautiful products available from Midwestern Wood Products.(309) 266-9771

STOCK No.	STYLE	Pcs. PER BOX
951	DELUXE BULLNOSE OUTSIDE	10
952	DELUXE BULLNOSE INSIDE	10
953	DELUXE BULLNOSE SPLAYED OUTSIDE	10
954	DELUXE BULLNOSE SPLAYED INSIDE	10
955	DELUXE SQUARE OUTSIDE	10
956	DELUXE SQUARE INSIDE	10
960	STANDARD BULLNOSE OUTSIDE	20
961	STANDARD BULLNOSE INSIDE	20

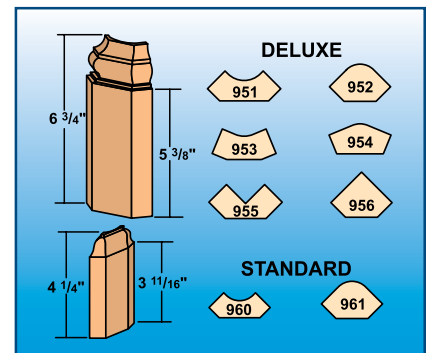

3/4" R. Molded Corners

- 0903 is designed to finish 2 Bullnose Outside Corners that adjoin at a 90° angle
- 0904 is designed to finish 3 Bullnose Outside Corners that adjoin at 90° outside angles
- 0905 is designed to finish 3 Bullnose Inside Corners that adjoin at 90° inside angles
- 0911 is designed to finish 2 Bullnose Outside Corners and 1 Splayed Outside Corner adjoining at an outside off angle corner
- 0912 is designed to finish 2 Bullnose Outside Corners that adjoin at a 135° angle
- 0917 joins a 3/4" Bullnose Outside Corner and transitions to a square bottom corner for simple installation of the baseboard
- 0937 joins to a 3/4" Bullnose Splayed Corner and transitions to a square bottom corner for simple installation of the baseboard

STOCK No.	Pcs. PER BOX
0903M	10
0903	50
0904M	10
0904	50
0905M	10
0905	50
0911M	10
0911	50
0912M	10
0912	50
0917M	10
0917	50
0937M	10
0937	50

