

# REM-PACK-12

## Twelve Remote Control Kit

# Technical Specifications

The Intelix REM-PACK-12 is a complete, pre-programmed remote control system including wiring accessories, IR to serial control modules, and push-button remote controls. Designed for the Intelix Audisey Athena matrix mixer/amplifier, the REM-PACK-12 features visual and auditory feedback, multiple label options, and password protection.

## Specifications

### Kit Contents

- (12) CB-1000 remote controls
- (1) Ion-LT IR/serial controller
- (12) CW-TB wiring blocks
- (13) 12VDC power supplies
- (12) 24-sheet CB-1000 button caps
- (12) single gang decora plates
- (12) 6' IR cables
- (12) IR breakout cables
- (1) Athena Designer Software CD

### ION-LT Dimensions

### CW-TB Dimensions

### CB-1000 Dimensions

### CB-1000 Form Factor

### Regulatory

- 5.10"H x 2.50"W x 1.10"D
- 1.75"H x 2.00"W x 0.50"D
- 4.25"H x 2.38"W x 1.25"D
- Single-gang decora
- UL, RoHS

### CB-1000 Feedback

### CB-1000 Security

### Power Supplies

### CB-1000 Max Power Consumption

### ION-LT Max Power Consumption

### CB-1000 Current-Limiting Resistor

### Shipping Weight

### Warranty

### Ordering Information

- Audible button click; button backlighting
- Built-in passcode
- 12 VDC
- 100 mA
- 285 mA
- 360 Ohm/ 8 mA drive
- 16 lbs.
- 2 years
- REM-PACK-12

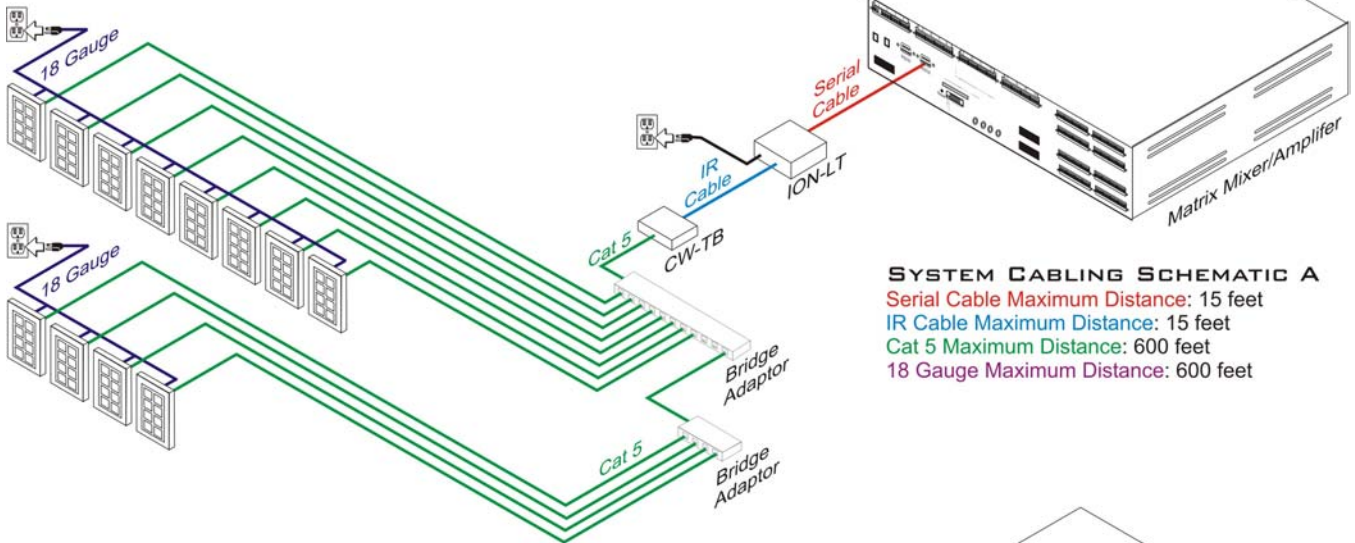

**SYSTEM CABLEING SCHEMATIC A**  
 Serial Cable Maximum Distance: 15 feet  
 IR Cable Maximum Distance: 15 feet  
 Cat 5 Maximum Distance: 600 feet  
 18 Gauge Maximum Distance: 600 feet

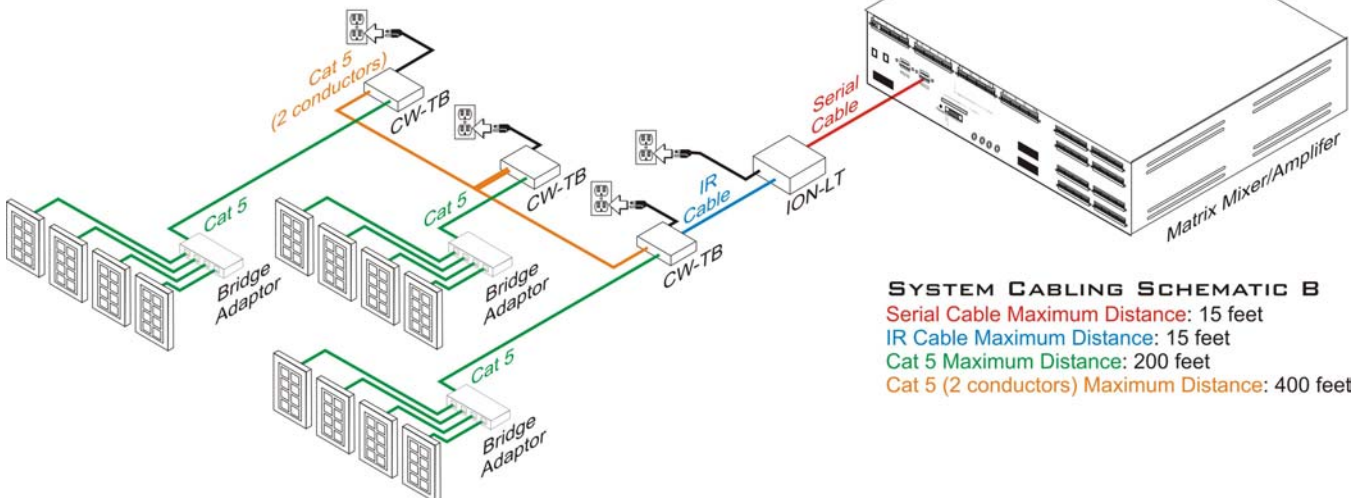

**SYSTEM CABLEING SCHEMATIC B**  
 Serial Cable Maximum Distance: 15 feet  
 IR Cable Maximum Distance: 15 feet  
 Cat 5 Maximum Distance: 200 feet  
 Cat 5 (2 conductors) Maximum Distance: 400 feet

\*Matrix mixer/amplifier, cabling, and bridge adaptor sold separately. Intelix recommends Intelix Comet-BA4 and the Comet-BA11 bridge adaptors.

[www.intelix.com](http://www.intelix.com)



2222 Pleasant View Road  
 Suite #1  
 Middleton, WI 53562

Phone: 608-831-0880  
 Toll-Free: 1-866-4-MATMIX  
 Fax: 608-831-1833

# REM-PACK-12

## Twelve Remote Control Kit

# Technical Specifications

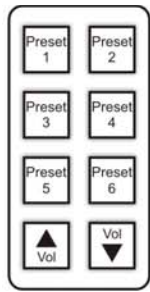

**Remote 1 Programming**

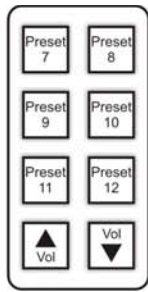

**Remote 2 Programming**

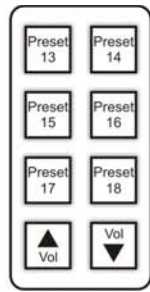

**Remote 3 Programming**

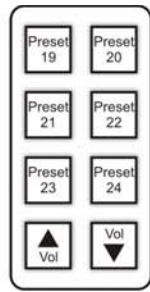

**Remote 4 Programming**

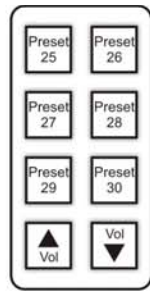

**Remote 5 Programming**

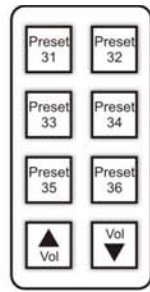

**Remote 6 Programming**

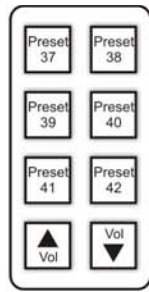

**Remote 7 Programming**

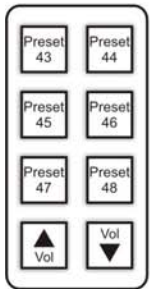

**Remote 8 Programming**

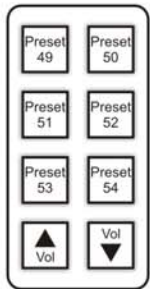

**Remote 9 Programming**

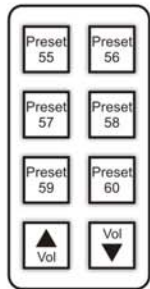

**Remote 10 Programming**

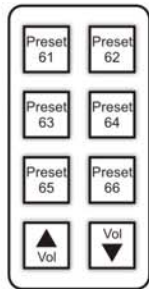

**Remote 11 Programming**

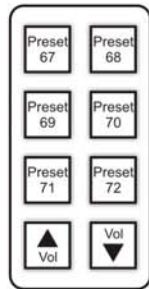

**Remote 12 Programming**

▲ Each eight button remote control arrives labeled and pre-programmed with each button tied to a customizable Intelix Audisey Athena software preset.

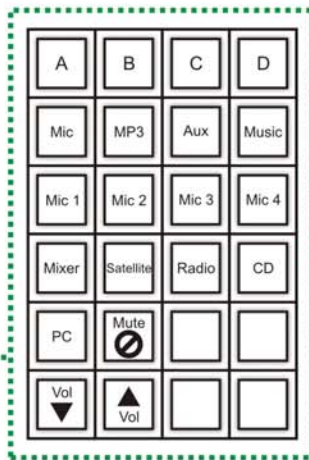

◀ Each remote control includes 24 button caps for custom labeling.

Each remote control fits in a standard single-gang wallbox with a standard decora plate. ▶

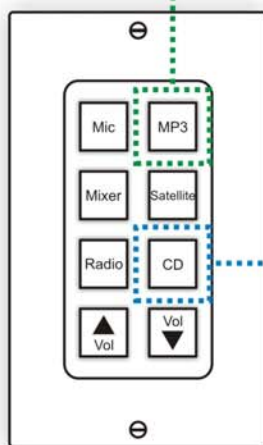

To adjust the remote control's programming, simply reconfigure the system preset in the Intelix Audisey Athena Designer Software. System presets may include input Digital Signal Processing (DSP) and output Digital Signal Processing presets. ▼

