

SAI Series Stand Alone Quartz Clock

Description

The SAI Quartz Series clocks are the ideal solution for an affordable and chic analog clock. This series has a vast selection of dials and hands for a stylish, contemporary look. Dials range from our standard 12 or 24 hour version to sleek new designs that we have developed. We provide multiple options for hour and minute hand selections, from standard hands to unique and different styles of hands that give the clocks a certain panache. Our cases come in a wide variety of custom colors from green to orange, as well as our standard black and white. Another option that we offer is plastic cases and crystals, for a more cost-effective alternative. SAI clocks are available in a double mount housing which has a variety of different lengths and colors. The SAI Series clocks have a low profile, smooth surface metal case, or a smooth surface ABS case. This clock series is available in both 12" and 16" round cases. This SAI Series comes with a shatterproof polycarbonate crystal, or an optional polystyrene crystal in both size models. The SAI clocks work on a single "AA" battery making it efficient and inexpensive to maintain. This line of clocks is also compact, energy efficient and reliable. Sapling quartz analog clocks are the perfect choice for design and versatility.



Ordering Info: Page 21

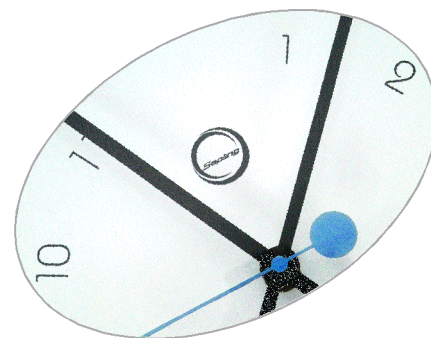

Highlights

- ▶ Proven time-keeping accuracy and reliability
- ▶ Hour, minute and second hands
- ▶ Custom colors and plating available
- ▶ Complete stand-alone capability
- ▶ Works on a single "AA" battery
- ▶ Available in 12" or 16" round case
- ▶ Low profile—slim case design
- ▶ Smooth surface metal case (optional ABS plastic cases are available)
- ▶ A plethora of hand and dial designs
- ▶ Variety of lengths and colors for double mount
- ▶ Shatterproof, side molded polycarbonate crystal (optional polystyrene plastic crystals are available)
- ▶ Made in U.S.A.



Architectural & Engineering Specifications

The quartz analog clock shall be a Sapling SAI Series analog clock and will be used as a stand-alone analog clock. The clock will have a low-profile, semi-flush smooth surface metal case. The crystal will be a shatterproof, side molded polycarbonate material. Glass and visible molding marks are unacceptable. The clock shall have a white dial with black numerals. Dials are to be made of durable polystyrene materials. The clock is to have black hour and minute hands, as well as a red second hand. The movement is to be a quartz movement with an accuracy of ± 0.8 sec./day @ 1.5 volts. The clock shall have a battery life of approximately one (1) year. The quartz movement is to operate at a frequency of 32.768 KHz. The Sapling SAI Series analog clock shall operate on a single "AA" battery.



Accessories: Page 77



Specifications

Battery Type/Size:	1.5 volts / "AA"
Quartz Frequency:	32.768 KHz
Operating Range:	1.2–1.7 volts
Current Consumption:	0.110 mA
Accuracy:	± 0.8 sec/day @ 1.5 V
Temperature Range	
Operating:	-20°C–60°C
Storage:	-20°C–70°C
Display:	12 or 24 hour format
Color:	Standard black or white (custom colors available)
Clock Size:	12.81" diameter, 1.2" depth 16.81" diameter, 1.6" depth
Case:	Shallow profile, smooth surface metal case (optional ABS plastic cases available)
Crystal:	Shatterproof, side molded polycarbonate crystal (optional polystyrene plastic crystals)
Movement Dimensions: (L x W x D)	2.286" x 2.174" x .648"
Shipping Box Dimensions: (L x W x D)	12"–15" x 16.25" x 2.5" 16"–18" x 19.25" x 3.5"
Shipping Weight:	12"–4 lbs. 16"–6 lbs.
Mounting Kit Includes:	2–blue plastic anchors 2–10 x 1.5 sheet metal screws

Mechanical Drawing

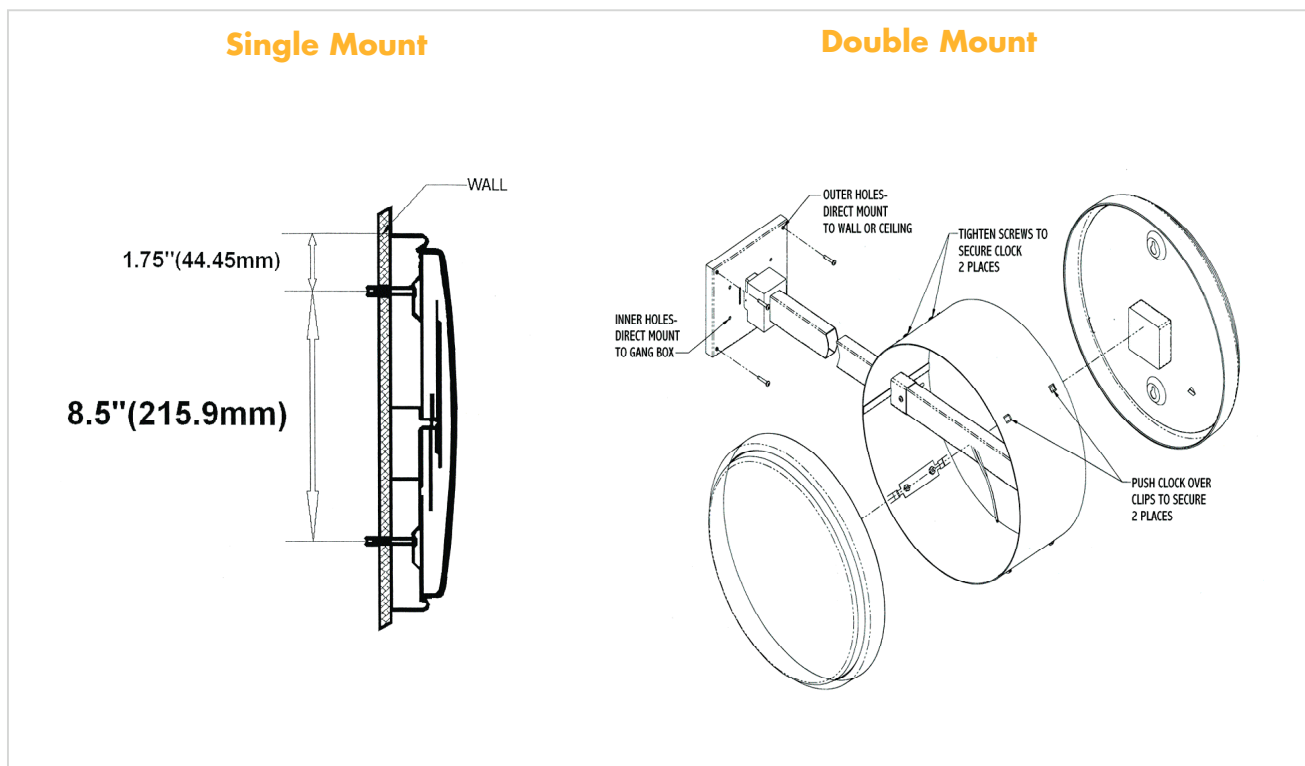

Hands Options

STANDARD CHOICE



Style 1

CUSTOM CHOICES

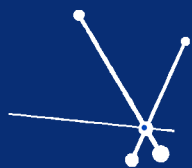

Style A



Style B

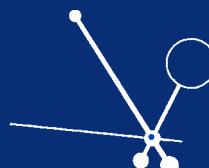

Style C



Style D

Dial Options

STANDARD CHOICE

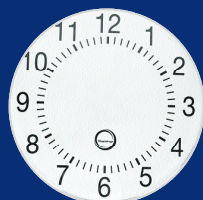

12 Hour
Style 1



24 Hour
Style 2

CUSTOM CHOICES

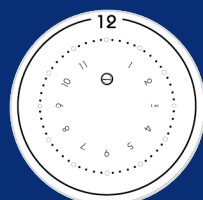

Style A



Style B

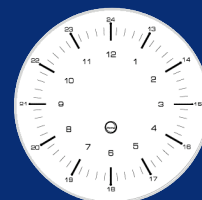

Style C

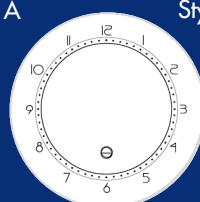

Style D

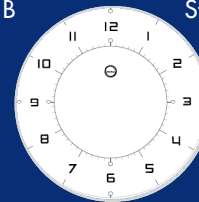

Style E

Color Options

STANDARD CHOICE



Black
Style 1

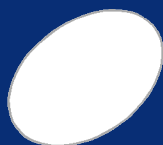

White
Style 2



#645
Style A



#188
Style B



#281
Style C



#519
Style D



#166
Style E

CUSTOM CHOICES

Ordering Information

Analog Clock

SAI-ACS-ZZR-OHD

A=Case/Crystal
1=Metal/
Polycarbonate
2=Plastic/
Polystyrene

C=Color
1=Black
2=White
Other=
(see chart)

ZZ=Clock Size
12=12"
16=16"

H=Hands
See chart
Style 1
Style A-D

D=Dial
See chart
Style 1 or 2
Style A-E

Double Mount Bracket

SAB-1CD-ZZR-OL

C=Color
1=Black
2=White
Other=
(see chart)

ZZ=Clock Size
12=12"
16=16"

L=Pole Length
Standard: 04=4"
Optional: 12=12"
24=24"
36=36"
48=48"

Options:

Additional Power Kits: A-MK-QS-1

Surface Mount Ring: 12": A-MOUNT-12S-1 or 16": A-MOUNT-16S-1
(See page 79)

Universal Mounting Bracket: M-UMB-12-1 (See page 79)

Example:

SAB-1BD-12R-024: 12" Double Mount Bracket, Black, 24" Length

SAB-1BD-16R-036: 16" Double Mount Bracket, Black, 36" Length