

Standard Features

- **Motor:** Reversing, brushless, capacitor-run 115 VAC 50/60 Hz, single phase
- **Overload protection:** Integral thermal overload protection for motor windings with automatic reset
- **Gear train:** Permanently lubricated
- **Corrosion resistant housing:** Zytel FR50 engineered resin rated Type 4X with stainless steel trim
- **ISO mounting configuration**
- **Conduit:** Two 1/2" NPT conduit entries to eliminate cross feed between control, feedback, and power signals
- **Position indication:** Highly visible position indicator for positive position of valve
- **Declutchable manual override:** Push down on handle and rotate in the appropriate direction (CCW for open, CW for close)
- **Limit switches:** Standard end of travel limit switches can be used for light indication (not to be use with PLC for position confirmation)
- **Corrosion resistant mounting:** Mounting is with PPG or stainless steel bracket, stainless steel coupling, and stainless steel hardware
- **CE compliant motor:** All 115 VAC and 230 VAC motors are CE compliant and stamped as such
- **Extended duty cycles:** Our extended duty cycles are ideal for modulating and high cycling applications
- **Output torque:** Series 94 electric actuators have an output torque range from 150 in./lbs. to 300 in./lbs.
- **Enclosure:** Corrosion proof weatherproof rated Type 4X
- **Captivated SS hex head slotted cover screws**
- **RoHS compliant**



Options

- Auxiliary (additional) limit switches
- Feedback potentiometer
- Heater and thermostat
- Positioner (modulating PCB)
- Mechanical brake
- Transmitter
- Cycle length control module (CLC)
- Two-wire control
- Center-off
- Failsafe battery back up (Protek)
- Voltages
- Local Remote Station

See page 194 for more details regarding options.

Engineering Specifications

Size: A94, B94

Torque: 150-300 in./lbs

Voltage: 120 VAC 1Ph 50/60 Hz

Amp Draw: A94 .5A, B94 .8A

Conduit Entry: Two (2) 1/2" NPT

Max Ambient Temperature: 150° F

Switches: Two single pole, double throw (Two SPDT)
15 amp rated

Cycle Time per 90°: A94, B94: 5 seconds

Engineering Data

Model	Torque (in./lbs)	115 VAC		230 VAC		12 VDC		24 VDC		12 VDC		24 VAC		Cycle Time per 90 Degrees (seconds)*	Weight (lbs)
		Amp Draw	Duty Cycle	Amp Draw	Duty Cycle	Amp Draw	Duty Cycle	Amp Draw	Duty Cycle	Amp Draw	Duty Cycle	Amp Draw	Duty Cycle		
A94	150	0.5	100%	0.4	100%	2.0	75%	4.0	75%	2.0	75%	4.0	75%	5	3.5
B94	300	0.8	75%	0.6	75%	2.0	75%	4.0	75%	2.0	75%	4.0	75%	5	3.5

Note: Amp rating is considered locked rotor. Duty cycles are for ambient temperature (73° F).

*Cycle times are approximate.

Parts List

PARTS LIST			
NO.	Part Number	Quantity	Description
1	7403002	1	Base
2	7403000	1	Base Seal
3	7403017	1	Output Couplin
4	7403005	2	Coupling Gasket
5	7403004	1	Motor
6	7403022	2	Motor Screw
7	7403011	1	Base Plate
8	7401420	1	Terminal Block 1-8
9	7401425	1	Terminal Block 9-16
10	7401600	4	Terminal Block Screw
13A	7401948	1	4.2 mFD Capacitor-A94
13B	7402004	1	6.7 mFD Capacitor-B94
14	7401460	2	Limit Switch
15	7401620	2	Limit Switch Screw
16	7403016	1	Outer Shaft
17	7403006	2	Outer Shaft Gasket
18	7403009	2	Retaining Ring
19	7403018	2	Standoff
20	7403014	2	Base Plate Screw
21	7401480	2	Cam
22	7401740	4	Cam Set Screw
23	7403010	1	Pin
26	7403007	1	Base Gasket
27	7403001	1	Cover
28	7403020	1	Cover Seal
33	7403032	8	Cover Screw
34	7403003	1	Handle
35	7401700	1	Handle Screw

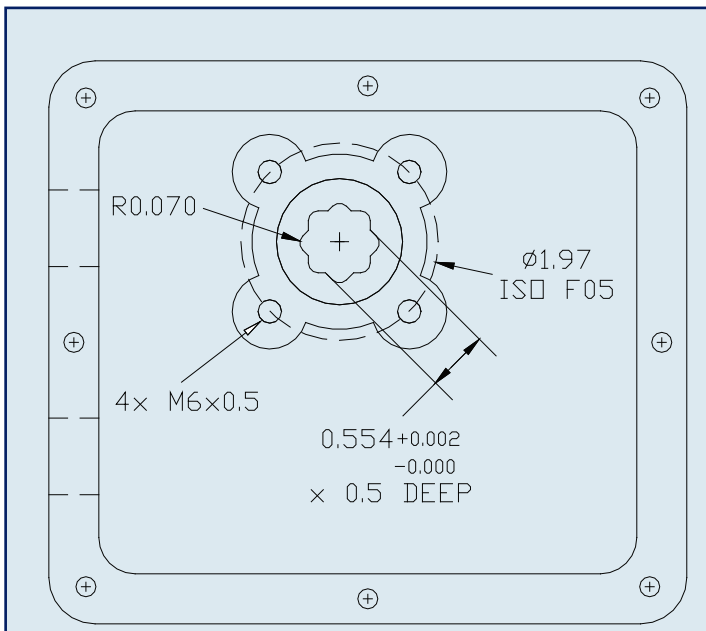
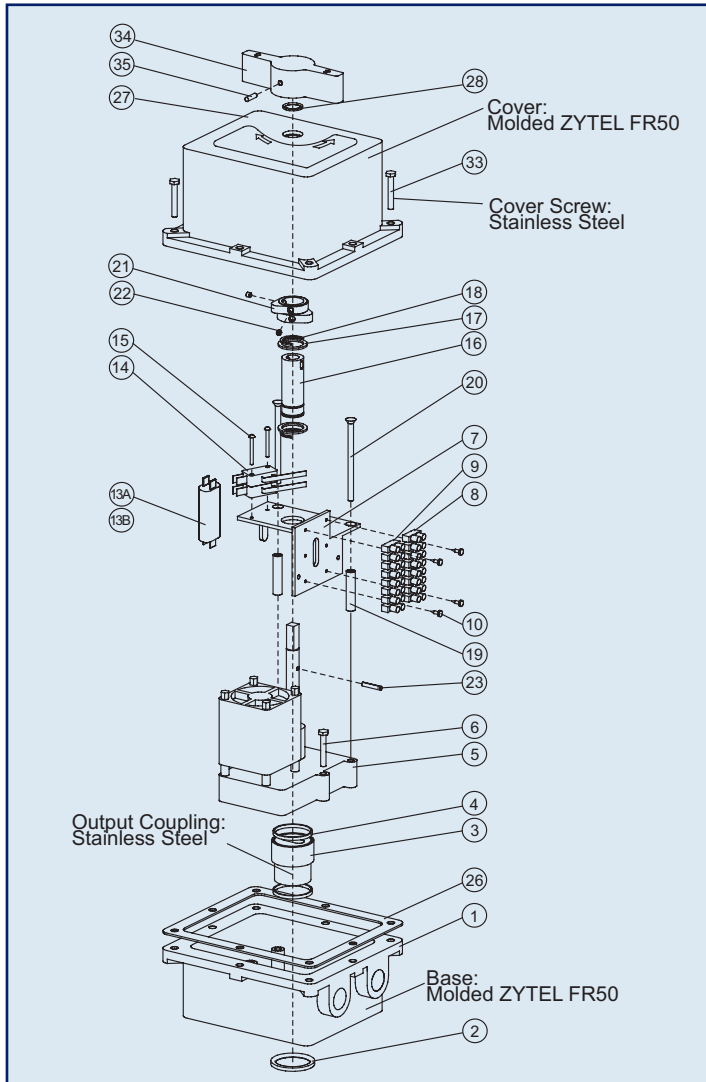

Sample Specification

All Series 94 electric actuators shall have a thermally protected, bi-directional (reversing type), capacitor run motor with a permanently lubricated gear train. 115 VAC and 230 VAC motors shall conform to CE and be indicated on motor housing. Actuator shall have a Zytel FR50 engineered resin housing with stainless steel trim, rated Type 4X. Each actuator to have a declutchable manual override, visual position indication, ISO mounting configuration, and be RoHS compliant, as manufactured by Asahi/America, Inc.