



CHEMIQUIP PRESSURE SNUBBERS

PROTECT HYDRAULIC & PNEUMATIC PRESSURE SENSITIVE DEVICES

- Insure steady, accurate Pressure response
- Protect pressure sensitive Instruments against pulsation or surges
- Increase instrument life.

WHEN ORDERING, PLEASE SPECIFY DESIRED POROSITY AS SHOWN UNDER "RECOMMENDED POROSITIES"

Description of Fitting		HOUSING MATERIAL			
		Cadmium-Plated Steel		Stainless Steel	
		Catalog Number	Weight	Catalog Number	Weight
Coupling Flare x Flare (similar to AN815)	¼" Flare (7/16"-20 NF-3)	AN-1	½ oz.	AC-1	½ oz.
	¾" Flare (9/16"-18 NF-3)	AN-6	1 oz.	AC-6	1 oz.
	½" Flare (¾"-16 NF-3)	AN-8	2 oz.	AC-8	2 oz.
Coupling Flare x NPT (similar to AN816)	¼" Flare (7/16"-20 NF-3) x ¼" NPT Male	12BN-1/12MR-4	½ oz.	12BC-1/12MRS-4	½ oz.
	¾" Flare (7/16"-20 NF-3) x ¼" NPT Male	25BN-1/25MR-4	½ oz.	25BC-1/25MRS-4	½ oz.
	½" Flare (9/16"-18 NF-3) x ¼" NPT Male	25BN-6/25MR-6	1 oz.	25BC-6/25MRS-6	1 oz.
Elbow Flare (similar to AN821)	¼" Flare (7/16"-20 NF-3)	LN-1	1 oz.	LC-1	1 oz.
	¾" Flare (9/16"-18 NF-3)	LN-6	2 oz.	LC-6	2 oz.
	½" Flare (¾"-16 NF-3)	LN-8	3 oz.	LC-8	3 oz.
Tee Flare (similar to AN824)	¼" Flare (7/16"-20 NF-3)	TN-1	2 oz.	TC-1	2 oz.
	¾" Flare (9/16"-18 NF-3)	TN-6	3 oz.	TC-6	3 oz.
	½" Flare (¾"-16 NF-3)	TN-8	4 oz.	TC-8	4 oz.
Bulkhead Coupling Flare (similar to AN832)	¼" Flare (7/16"-20 NF-3)	AHN-1	1 oz.	AHC-1	1 oz.
	¾" Flare (9/16"-18 NF-3)	AHN-6	2 oz.	AHC-6	2 oz.
	½" Flare (¾"-16 NF-3)	AHN-8	3 oz.	AHC-8	3 oz.
Reducing Coupling Flare x Flare (similar to AN919)	¼" Flare (7/16"-20 NF-3) x ¾" Flare (5/16"-20 NF-3)	ARN-1	1 oz.	ARC-1	1 oz.
	¾" Flare (9/16"-18 NF-3) x ¼" Flare (7/16"-20 NF-3)	1ARN-6	1 oz.	1ARC-6	1 oz.
	½" Flare (¾"-16 NF-3) x ¼" Flare (7/16"-20 NF-3)	1ARN-8	2 oz.	1ARC-10	2 oz.
	¾" Flare (9/16"-18 NF-3) x ¾" Flare (7/16"-20 NF-3)				
Flare Tube Bushing Gasket Seal x Flare (similar to AN894)	¼" Tube x ¼" Flare (7/16"-20 NF-3) x (7/16"-20 NF-3)	1KAN-1	2 oz.	1KAC-1	2 oz.
	¾" Tube x ¼" Flare (9/16"-18 NF-3) x (7/16"-20 NF-3)	6KAN-1	2 oz.	6KAC-1	2 oz.
	¾" Tube x ¾" Flare (9/16"-18 NF-3) x (9/16"-18 NF-3)	6KAN-6	2 oz.	6KAC-6	2 oz.
	½" Tube x ¼" Flare (¾"-16 NF-3) x (7/16"-20 NF-3)	8KAN-1	3 oz.	8KAC-1	3 oz.
	½" Tube x ¾" Flare (¾"-16 NF-3) x (9/16"-18 NF-3)	8KAN-6	3 oz.	8KAC-6	3 oz.

*Intermediate porosities are available on special order. Other styles of fittings available; prices on application

TYPE A

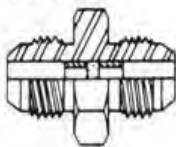

TYPE B

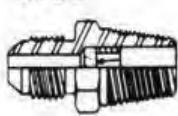

TYPE L

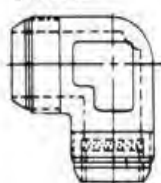

TYPE T

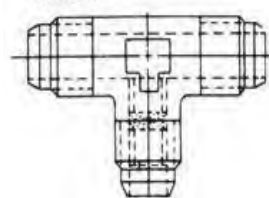

TYPE AH

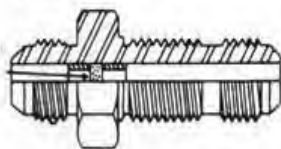

TYPE AR

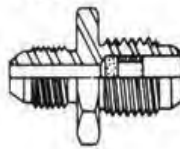

TYPE KAC

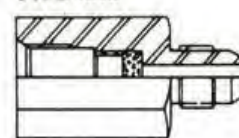



CHEMIQUIP POROUS METAL PRESSURE SNUBBERS

Insure the reliable instrumentation needed for performance and safety by specifying Chemiquip Snubbers for hydraulic and pneumatic systems.

ALL SAE, AS, AN, AND MS TYPE FITTINGS ARE AVAILABLE AS SNUBBERS

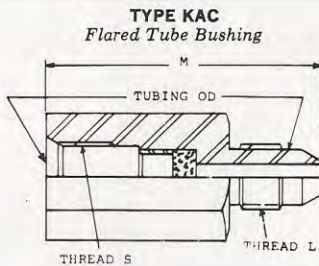
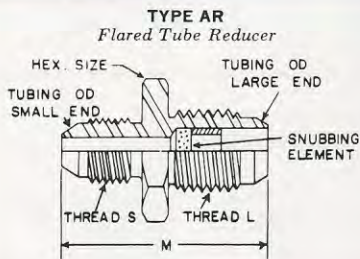
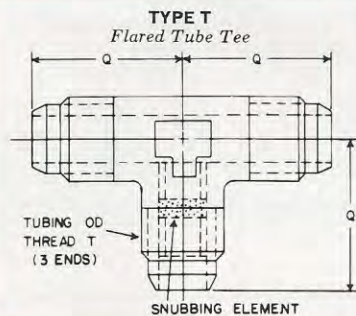
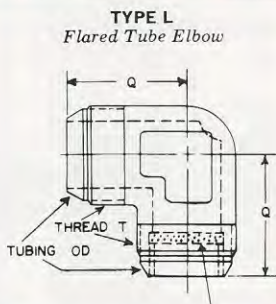
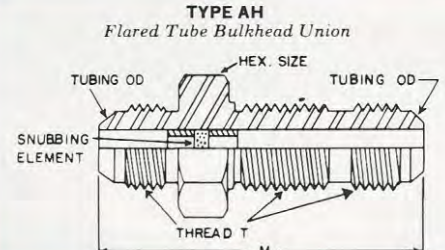
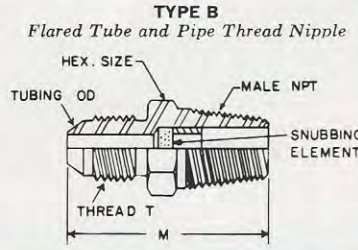
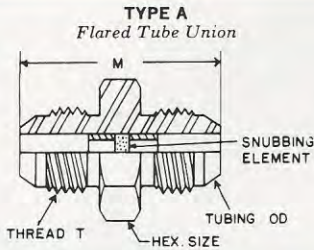

ORDERING INFORMATION:
When ordering, specify Part No. and Porosity designation. If required, CHEMIQUIP Engineers will aid in the selection of proper metal or porosity.

SNUBBER DIMENSIONS

Catalog number	Tubing Size (inches)	HEX (inches)	DIMENSIONS		THREAD T	THREAD NPT
			M	Q		
AC-1	1/4	11/16	1 1/4		7/16"-20	
AC-6	3/8	13/16	1 3/8		9/16"-18	
AC-8	1/2	1	1 9/16		3/4"-16	
12 BC-1	1/4	1/2	1 7/64		7/16"-20	1/8"
25 BC-1	1/4	9/16	1 3/8		9/16"-18	1/4"
25 BC-6	3/8	3/4	1 3/8		3/4"-16	1/4"
LC-1	1/4		57/64		7/16"-20	
LC-6	3/8		1 1/16		9/16"-18	
LC-8	1/2		1 1/4		3/4"-16	
TC-1	1/4		55/64		7/16"-20	
TC-6	3/8		1 1/64		9/16"-18	
TC-8	1/2		1 7/32		3/4"-16	
AHC-1	1/4	11/16	2 3/64		7/16"-20	
AHC-6	3/8	13/16	2 13/32		9/16"-18	
AHC-8	1/2	1	2 29/64		3/4"-16	
ARC-1	1/8 x 1/4	11/16	1 1/4		5/16"-24	7/16"-20
1 ARC-6	1/4 x 3/8	13/16	1 13/32		7/16"-20	9/16"-18
1 ARC-10	1/4 x 1/2	1	1 17/32		7/16"-20	3/4"-16
1 KAC-1	1/4 x 1/4	11/16	1 45/64		7/16"-20	7/16"-20
6 KAC-1	3/8 x 1/4	13/16	1 25/64		9/16"-18	7/16"-20
6 KAC-6	3/8 x 3/8	3/4	1 5/16		9/16"-18	9/16"-18
8 KAC-1	1/2 x 1/4	1	1 37/64		3/4"-16	7/16"-20
8 KAC-6	1/2 x 3/8	1	1 35/64		3/4"-16	9/16"-18

STANDARD MATERIALS OF CONSTRUCTION

Housing:

- 303 Stainless Steel
- 316 Stain less Steel
- Cadmium Plated Carbon Steel
- Aluminum
- Monel

Porous Disc:

- 316 Stainless Steel
- Monel available with Special Order