

Rubber Fab Technologies Group's

TUF-STEEL[®]

A FULL LINE OF
WORLD CHAMPION
GASKETS

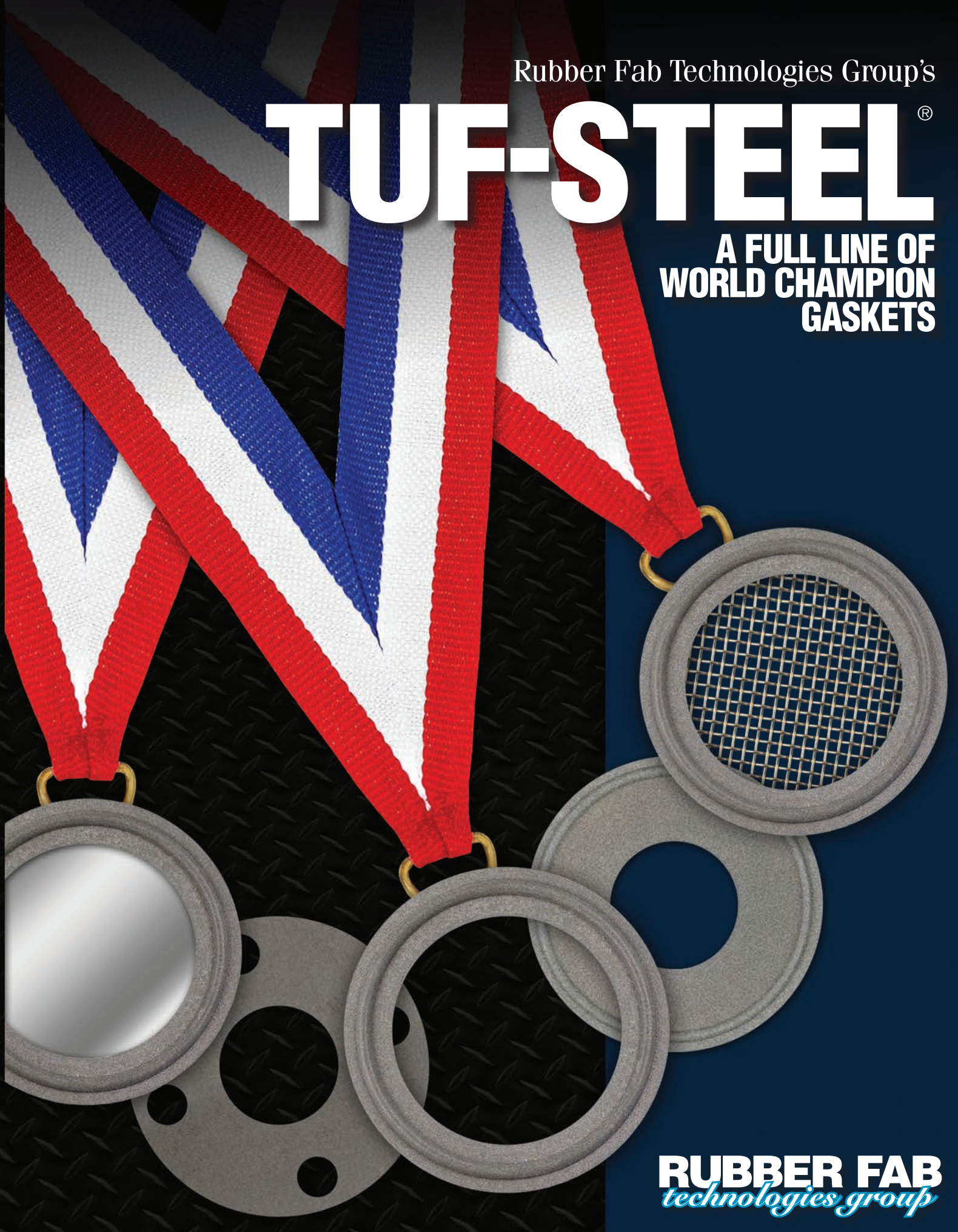

RUBBER FAB
technologies group

TUF-STEEL® IS THE TRUE CHAMPION BECAUSE TUF-STEEL® GOES THE DISTANCE.

Composed of a unique proprietary blend of non-pigmented PTFE and 316L passivated and atomized Stainless Steel, you can bet on any Tuf-Steel® seal for leak-proof performance and outstanding durability. There is no beating the Tuf-Steel® family in SIP, WFI and hot oil applications because Tuf-Steel® maintains seal integrity in applications with large temperature variations. With a **500 steam cycle guarantee**, this metal detectable gasket will easily out perform any elastomeric or perfluoroelastomer gasket and will remain in service for extended periods of time. It is the material of choice when chemical and heat resistance are required. Minimum creep and cold flow, non-stick, ultra-low absorption, no pigmentation and Tuf-Steel® will not revert. **This gasket is tough!**



RUBBER FAB
technologies group



TUF-STEEL® IS NOT JUST ANOTHER PRODUCT LINE

**It's the future of the
processing industry**

Testing and a decade of documented application usage has demonstrated that Tuf-Steel® is the choice for perfect surface performance, outstanding durability and extended service life. Tuf-Steel® is ideal for sanitary steam pipe connections in extreme temperature applications, such as frier and hot oil applications, with temperatures ranging from -350°F up to 550°F. The superior strength of Tuf-Steel® eliminates creep and cold flow providing a leak-free seal. Tuf-Steel® is available in: Type I Standard TC Gasket, Mini TC Gasket, Type II Flanged, Type III Envelope Style, Sanitary TC Screen Gasket, Sanitary TC Orifice Plate Gasket, Steam Trap Orifice Plate Gasket, Sheet, Solid Rod, Ansi Flange, and Custom Gaskets.

TUF-STEEL®

THE TECHNOLOGY OF TOUGH

A POWERFUL COMBINATION OF INNOVATION AND VALUE THAT PUNISH THE COMPETITION

The original Tuf-Steel® gasket, a Rubber Fab product innovation, is the strongest gasket in the pharmaceutical, biotech, food and beverage industries. Whatever your application, there's a gasket in the Tuf-Steel® family ready to do the job.

Tuf-Steel® is ideal for extreme temperature applications, such as steam, hot oil and friers, where temperatures range from -350°F to 550°F. Unlike traditional solid PTFE and PTFE envelope style gaskets, Tuf-Steel® does not revert, eliminating creep and cold flow, resulting in a leak free seal. Because the superior strength and chemical resistance of Tuf-Steel® allows it to go the distance without

leaking, it significantly reduces maintenance and system downtime by staying in place when cleaning and validating a system.

Testing and a decade of documented application usage has demonstrated that Tuf-Steel® is the choice for perfect surface performance, outstanding durability and extended service life in both SIP (steam in place) and WFI (water for injection) applications.

Contact Rubber Fab's Technical Sales Department at 973-579-2959 or sales@rubberfab.com for more information and a free Tuf-Steel® sample.

TUF-STEEL® Stands Up to Rigorous Conditions and Delivers Leak-Proof Performance

- 500 CIP/SIP cycles guaranteed
- Excellent expansion/contraction stability with minimal thermal expansion
- Excellent chemical resistance
- Stops leaks when correctly torqued (50 in./lbs. with Torque-Rite Model TR-50)
- Tuf-Steel® is a compression control gasket
- No gasket intrusion into the sanitary tube I.D.
- No obstruction of flow
- Maintains sealing stability in ΔT processes

PTFE and Stainless Steel TUF-STEEL® Offers Rugged Composition for Demanding Challenges

- Proprietary PTFE and Stainless Steel blend
- Metal detectable
- Rouging eliminated
- Non-pigmented
- Non-stick surfaces
- I.D. Pharmaceutical finish

The Exclusive Properties Of TUF-STEEL®

PROPERTY	ASTM METHOD	VALUE
Specific Gravity	D792	3.45
Tensile Strength	D4894	1928psi
Elongation @ Break	D4894	270%
Compressive Stress @ 1%	D695	832
Compressive Stress @ 5%	D695	2590
Compressive Modulus	D695	84200
Hardness	D2240	68
Temperature Low	Continuous	-350°F
Temperature High	Continuous	550°F

TUF-STEEL® Meets Stringent Standards

- U.S. Pharmacopeia Class VI Certification
- Cytotoxicity Criteria
- FDA CFR 21 177.1550
- 3-A Certified
- USDA
- Current Good Manufacturing Practices (CGMP)
- ASME-BPE Standards for Type I and Type II
- ADI Free® (Animal Derived Ingredient Free)





WHERE IT ALL BEGAN...
THE ORIGINAL TUF-STEEL®

TUF-STEEL® TYPE I TRI-CLAMP® GASKET

The original Tuf-Steel® Type I Tri-Clamp® style sanitary gasket is widely used in sanitary processing pipeline systems for Pharmaceutical, Biopharmaceutical, Food & Beverage, Dairy and Industrial industries. Specifically designed for demanding steam applications, high temperatures and hot oil applications.

AVAILABLE SIZES: 1/2" – 12"

Size in inches	Tri-Clamp® Type I	Size in inches	Tri-Clamp® Type I
1/2"	42MPG-TS-050	4"	40MPG-TS-400
3/4"	42MPG-TS-075	5"	40MOG-TS-500
1"	40MPG-TS-100	6"	40MOG-TS-600
1-1/2"	40MPG-TS-150	8"	40MOG-TS-800
2"	40MPG-TS-200	10"	40MOG-TS-1000
2-1/2"	40MPG-TS-250	12"	40MOG-TS-1200
3"	40MPG-TS-300		

Consult factory for DIN/ISO availability.





TUF-STEEL® TRI-CLAMP® MINI STYLE

The Tuf-Steel® Mini Tri-Clamp® sanitary gasket is widely used in sanitary processing pipeline systems for Pharmaceutical, Biopharmaceutical, Food & Beverage, Dairy and Industrial industries.

AVAILABLE SIZES: 1/2" – 3/4"

Size in inches	Mini Tri-Clamp®
1/2"	42MPG-TS-050
3/4"	42MPG-TS-075



TUF-STEEL® MINI STEAM TRAP

Steam trap mini orifice plates are an alternative to standard steam trap technology.

AVAILABLE SIZES: 3/4"

TUF-STEEL® TYPE II TRI-CLAMP® FLANGED STYLE

Type II, Flanged TC gaskets easily clip on to the sanitary ferrule and stay in place at any angle insuring alignment and keeping hands free to safely install the hinge clamp. Great for tight and hard to reach installation locations.

AVAILABLE SIZES: 1" – 12"

Size in Inches	Type II Tri-Clamp®
1"	40MPG-TS-F-100
1-1/2"	40MPG-TS-F-150
2"	40MPG-TS-F-200
2-1/2"	40MPG-TS-F-250
3"	40MPG-TS-F-300
4"	40MPG-TS-F-400
6"	40MOG-TS-F-600
8"	40MOG-TS-F-800
10"	40MOG-TS-F-1000
12"	40MOG-TS-F-1200

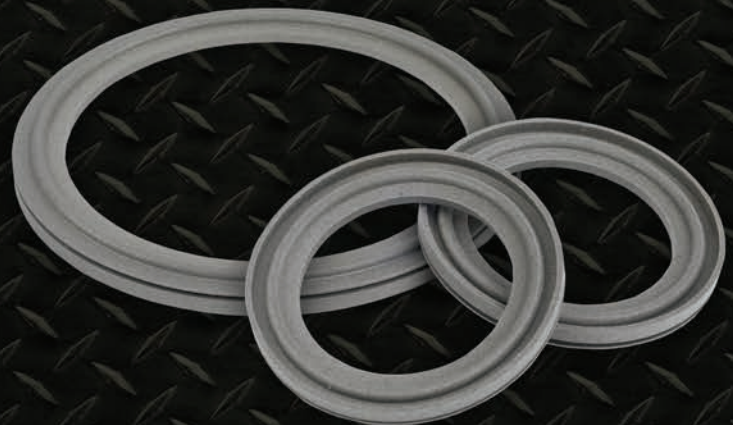

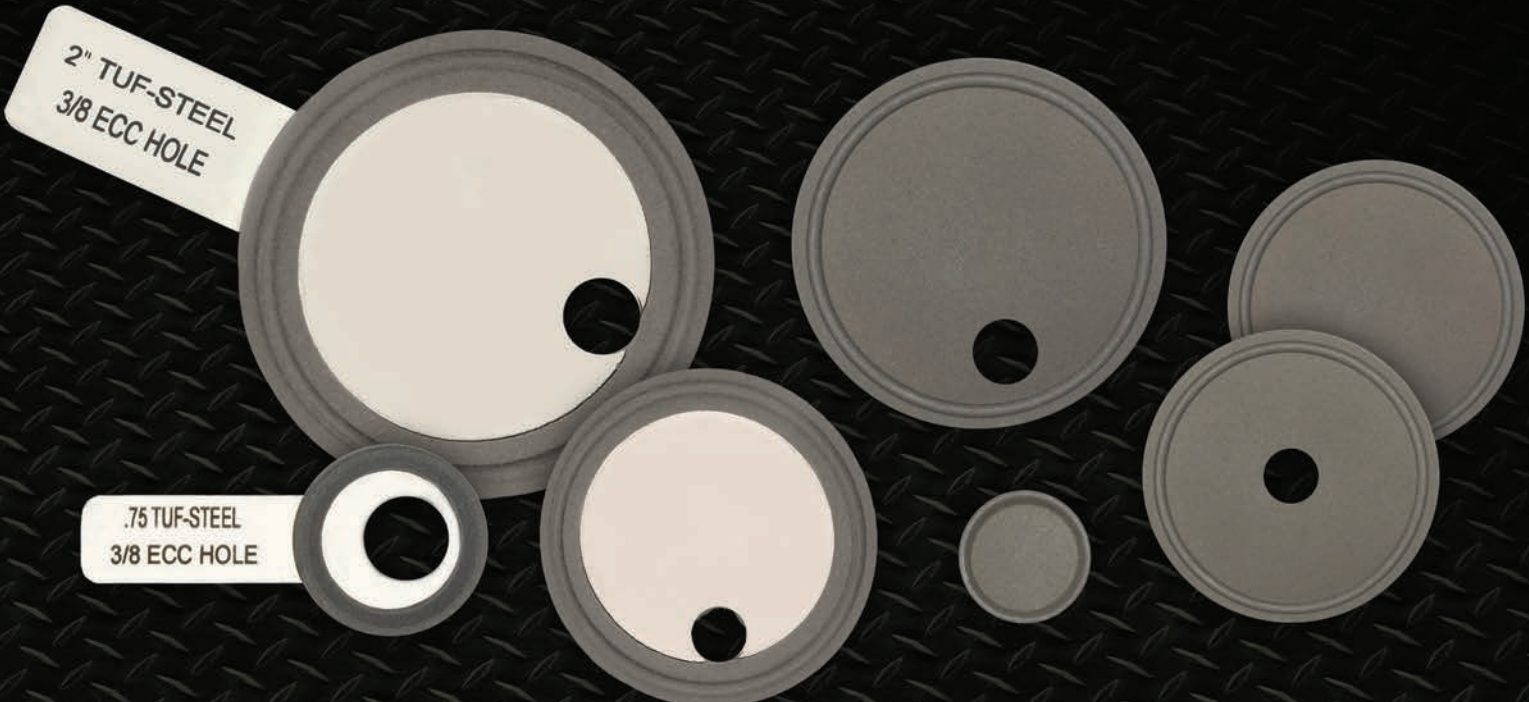

TUF-STEEL® TRI-CLAMP® ORIFICE PLATE GASKETS (SOLID & TUF-STEEL®/316 STAINLESS STEEL)

Size in inches	Orifice Plates-Solid Tuf-Steel®
1/2 & 3/4"	A80MPG-TS-050/075
1 & 1-1/2"	A80MPG-TS-100/150
2"	A80MPG-TS-200
2-1/2"	A80MPG-TS-250
3"	A80MPG-TS-300
4"	A80MPG-TS-400
5"	A80MPG-TS-500
6"	A80MPG-TS-600
8"	A80MPG-TS-800
10"	A80MPG-TS-1000
12"	A80MPG-TS-1200

Size in inches	Orifice Plates-Tuf-Steel® /SS
1/2"	A80MPG-TS-050-SS
3/4"	A80MPG-TS-075-SS
1"	A80MPG-TS-100-SS
1-1/2"	A80MPG-TS-150-SS
2"	A80MPG-TS-200-SS
2-1/2"	A80MPG-TS-250-SS
3"	A80MPG-TS-300-SS
4"	A80MPG-TS-400-SS
6"	A80MPG-TS-600-SS

* Add -TAB to end of part number for Tabbed Orifice Plate

Rubber Fab's innovative Tuf-Steel® Orifice Plate line includes a complete selection of Tuf-Steel®/316 Stainless Steel Orifice Plate gaskets in standard or tabbed style that can be custom drilled with an eccentric or concentric bore. Orifice Plate Tabs help to acknowledge that an orifice plate is "in line" and can be laser engraved to indicate the hole diameter, gasket size or user specified information. Orifice plates can advance your system's performance, adjust flow rates, balance backflow and equalize back pressure during SIP procedures.

AVAILABLE SIZES: 1/2" – 6"

LASER ENGRAVED GASKETS

Laser engraved gaskets insure process line identification and provide complete lot and batch traceability!

AVAILABLE SIZES: 1/2" – 4"



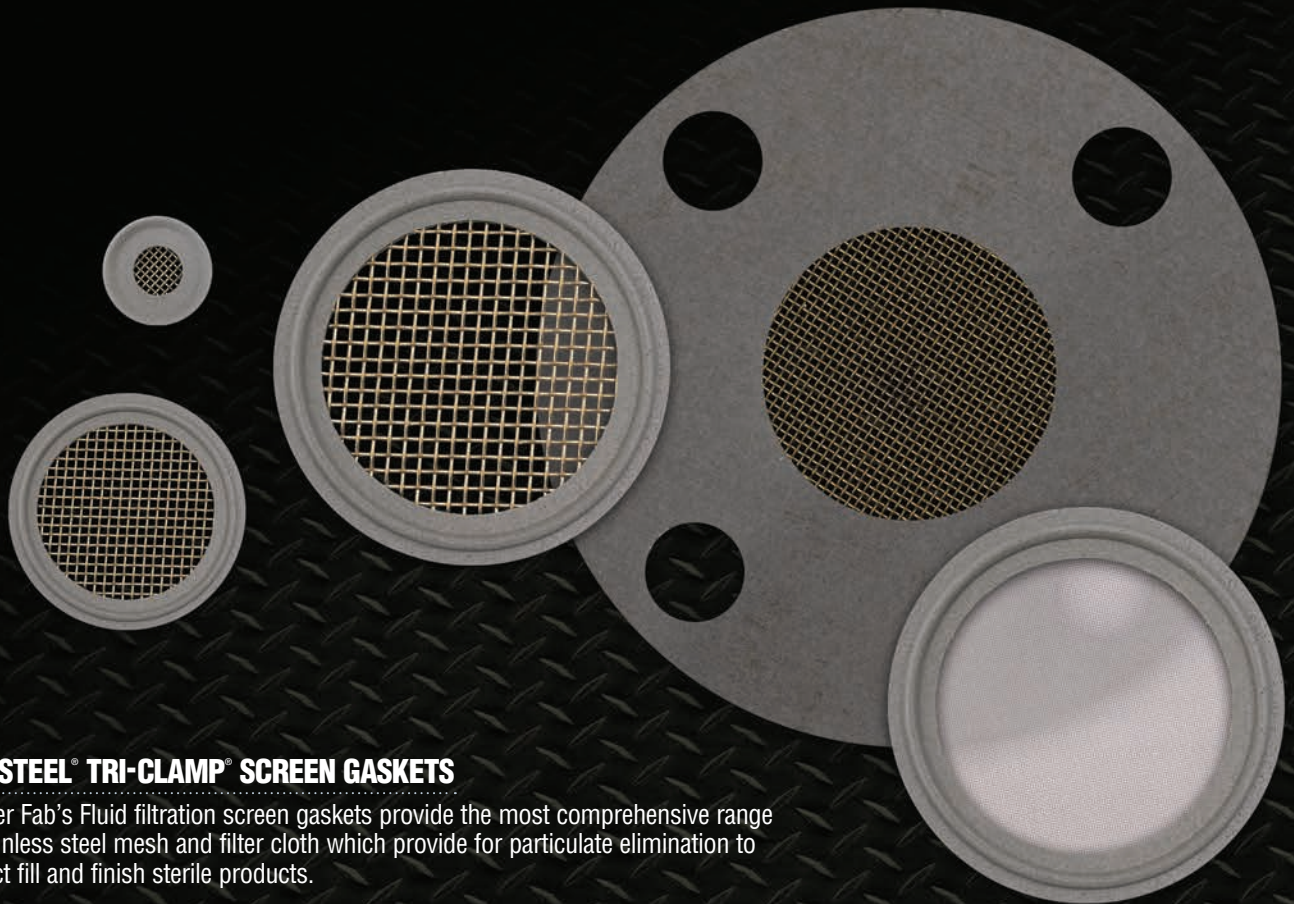

TUF-STEEL® TRI-CLAMP® SCREEN GASKETS

Rubber Fab's Fluid filtration screen gaskets provide the most comprehensive range of stainless steel mesh and filter cloth which provide for particulate elimination to protect fill and finish sterile products.

AVAILABLE SIZES: 1/2" – 6"

Size in inches	Screen Gaskets
1/2"	42MPGTSS050-XXSS
3/4"	42MPGTSS075-XXSS
1"	40MPGTSS100-XXSS
1-1/2"	40MPGTSS150-XXSS
2"	40MPGTSS200-XXSS
2-1/2"	40MPGTSS250-XXSS
3"	40MPGTSS300-XXSS
4"	40MPGTSS400-XXSS
6"	40MPG-SS600-XXSS

XX = mesh size

Stock Mesh Sizes Available: 10, 20, 40, 60, 80, 100

Consult Factory for other mesh and filter cloth sizes.

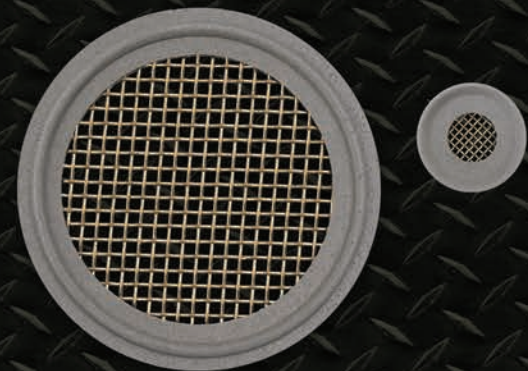

TUF-STEEL® BEVEL SEAT GASKETS

AVAILABLE SIZES: 1" – 4"

Size in inches	Bevel Seat
1"	40BSS-TS-100
1-1/2"	40BSS-TS-150
2"	40BSS-TS-200
2-1/2"	40BSS-TS-250
3"	40BSS-TS-300
4"	40BSS-TS-400

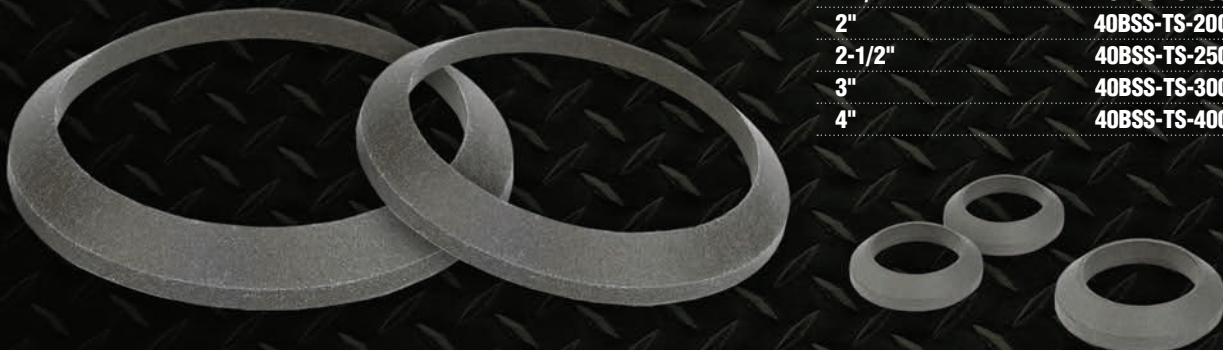

The Tuf-Steel® I-Line, John Perry and Bevel Seat gaskets are designed for use in sanitary processing pipeline systems for Pharmaceutical, Biopharmaceutical, Food & Beverage, Dairy and Industrial industries.

TUF-STEEL® I-LINE GASKETS

AVAILABLE SIZES: 1" – 8"

Size in inches	I-Line
1"	40IT-TS-100
1-1/2"	40IT-TS-150
2"	40IT-TS-200
2-1/2"	40IT-TS-250
3"	40IT-TS-300
4"	40IT-TS-400
6"	40IT-TS-600
8"	40IT-TS-800

TUF-STEEL® JOHN PERRY GASKETS

AVAILABLE SIZES: 1" – 4"

Size in inches	John Perry
1"	40JPG-TS-100
1-1/2"	40JPG-TS-150
2"	40JPG-TS-200
2-1/2"	40JPG-TS-250
3"	40JPG-TS-300
4"	40JPG-TS-400

TUF-STEEL® FULL FACE FLANGE AND RING GASKETS

Rubber Fab offers a complete size range of standard Full Face 150# and 300# Ansi Flange gaskets, as well as, Ring Gaskets specifically designed for demanding steam applications.

AVAILABLE SIZES: 1/2" – 12"

Size in inches	Full Face Flange
1/2"	XX-TS-050-150#-.125
3/4"	XX-TS-075-150#-.125
1"	XX-TS-100-150#-.125
1-1/4"	XX-TS-125-150#-.125
1-1/2"	XX-TS-150-150#-.125
2"	XX-TS-200-150#-.125
2-1/2"	XX-TS-250-150#-.125
3"	XX-TS-300-150#-.125
4"	XX-TS-400-150#-.125
5"	XX-TS-500-150#-.125
6"	XX-TS-600-150#-.125
8"	XX-TS-800-150#-.125
10"	XX-TS-1000-150#-.125
12"	XX-TS-1200-150#-.125

XX = FF for Flanged Face or RG for Ring Gasket

*Use 300# designation for 300# flanges.
Consult factory for larger sizes.

UNLIMITED POSSIBILITIES...

TUF-STEEL[®] CUSTOM FABRICATION

When your application demands products that stand up to extreme temperature conditions ranging from -350°F up to 550°F, look to Tuf-Steel[®]. Tuf-Steel[®] is ideal for sanitary steam pipe connections and anywhere outstanding durability and extended service life are required. Tuf-Steel[®] can be fabricated, machined, lathed or waterjet cut.

Contact Rubber Fab's Technical Sales Team at 973-579-2959 for all of your application requirements and the unlimited possibilities of Tuf-Steel[®].

TUF-STEEL[®] SOLID ROD

Rubber Fab's Tuf-Steel[®] Solid Rod can be machined into custom parts.

AVAILABLE ROD DIAMETER:
1/8" – 2"



TUF-STEEL[®] SHEET MATERIAL

Tuf-Steel[®] sheeting material can be waterjet cut into custom patterns.

AVAILABLE SIZES:
12" X 12"
24" X 24"
36" X 36"

AVAILABLE THICKNESS:
1/16" & 1/8"

Consult Factory for other sizes.



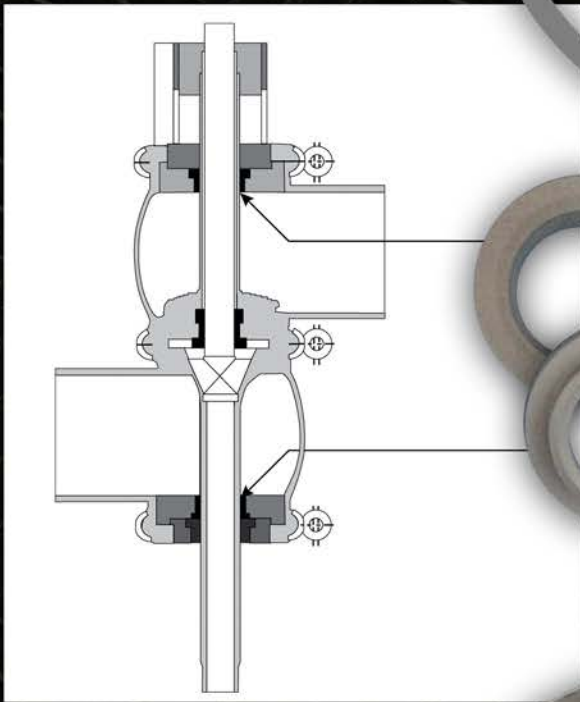



Rubber Fab's Hose, Hose Assemblies, Tubing, Fittings and Adapters

- High Purity Platinum Silicone Hose, Tubing, Sanitary Molded Ends
- PTFE & FEP Lined Smooth Bore & Convoluted Hose
- Metal Hose
- FDA Rubber Hose
- FDA PVC Hose, Tubing, Sanitary Molded Ends
- Sight Gauges: PTFE & Polysulfone
- Fittings & Adapters: 316L, Special Alloys & Non Metallic

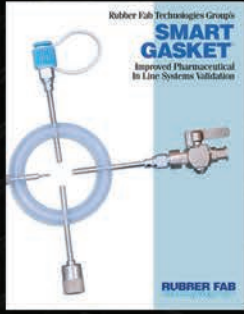
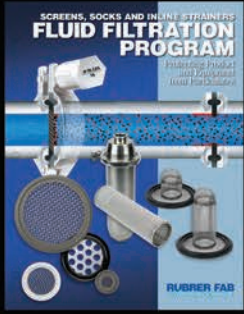
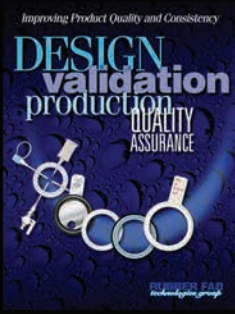

RUBBER FAB technologies group

26 Brookfield Drive • Sparta, NJ 07871
 973.579.2959 • Toll Free: 866.442.2959
 fax: 973-579-7275
 email: sales@rubberfab.com

www.rubberfab.com

Rubber Fab Technologies Group is a member of:



International Association of Food Industry Suppliers



Distributed by: