

# VIBROACOUSTICS®

Noise Control | Vibration Isolation | Restraint Systems

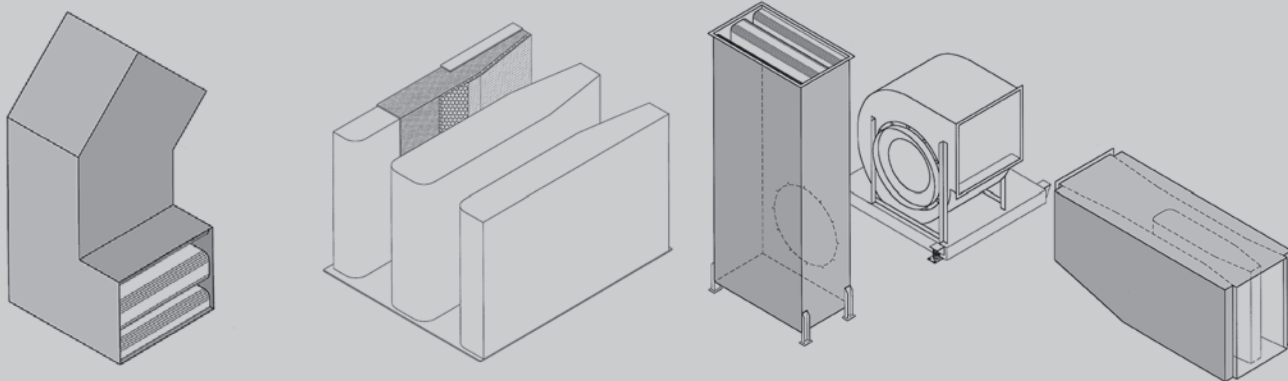

Wide Range of Silencers

## SILENCERS

### 1. RD: Rectangular Dissipative

Acoustical glass fiber is the primary sound-absorbing mechanism. Variable ranges of aerodynamic acoustical splitter thicknesses and air passage dimensions optimize acoustic performance and energy conservation.

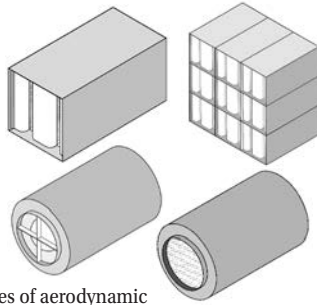

### CD: Circular Dissipative

Acoustical glass fiber is the primary method of attenuation. Variable ranges of aerodynamic body diameters and air passage dimensions optimize acoustic performance and energy conservation.

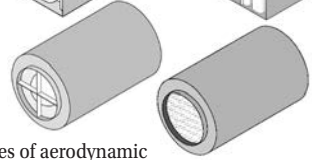

### 2. RFL: Rectangular Film Lined

The acoustical glass fiber is protected by a film liner such as Tedlar. Variable ranges of aerodynamic acoustical splitter thicknesses and air passage dimensions optimize acoustic performance and energy conservation. Acoustical spacers between perforated metal and films minimize acoustic performance degradation caused by the film.

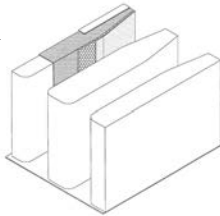

### CFL: Circular Film Lined

The acoustical glass fiber is protected by a film liner such as Tedlar. Variable range of aerodynamic acoustical center body diameters and air passage dimensions optimize acoustic performance and energy conservation. Acoustical spacers between perforated metal and films minimize acoustic performance degradation caused by the film.

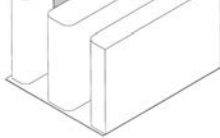

### 3. RNM: Rectangular No-Media

Silencers are void of glass fiber and any fill material whatsoever. The Helmholtz resonator mechanism is used as the primary sound reducing mechanism. Variable ranges of aerodynamic acoustical splitter thicknesses and air passage dimensions optimize acoustic performance and energy conservation.

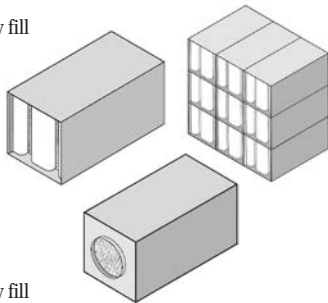

### CNM: Circular No-Media

Silencers are void of glass fiber and any fill material whatsoever. The Helmholtz resonator mechanism is used as the primary sound reducing mechanism. Variable ranges of internal geometries optimize acoustic performance and energy conservation.

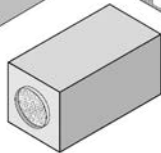

### 4. CENM: Circular Elbow No-Media

Silencers are void of glass fiber and any fill material whatsoever. The Helmholtz resonator mechanism is used as the primary sound reducing mechanism. Variable ranges of internal geometries optimize acoustic performance and energy conservation. Full 90 degree and/or partial bends allow the silencers to fit the duct configurations and available space.

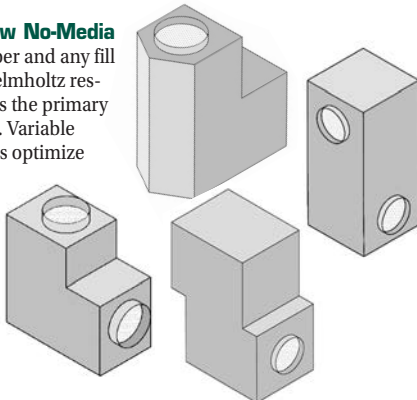

### 5. RED: Rectangular Elbow Dissipative

Acoustical glass fiber is the primary sound-absorbing mechanism. Full 90 degree and/or partial bends allow the silencers to fit the duct configurations and available space. Variable ranges of aerodynamic acoustical splitter thicknesses and air passage dimensions are designed to turn the air efficiently and optimize acoustic performance.

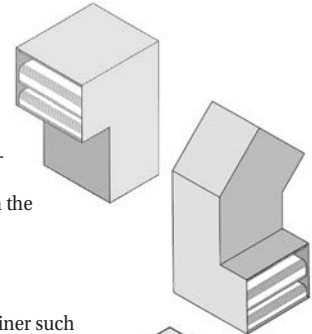

### REFL: Rectangular Elbow Film Lined

Acoustical glass fiber is protected by a film liner such as Tedlar. Acoustical spacers between perforated metal and films minimize acoustic performance degradation caused by the film. Full 90 degree and/or partial bends allow the silencers to fit the duct configuration and available space. Variable ranges of aerodynamic acoustical splitter thicknesses and air passage dimensions are designed to turn the air efficiently and optimize acoustic performance.

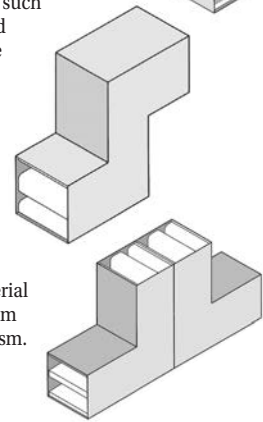

### RENM: Rectangular Elbow No-Media

Silencers are void of glass fiber and any fill material whatsoever. The Helmholtz resonator mechanism is used as the primary sound reducing mechanism. Full 90 degree and/or partial bends allow the silencers to fit the duct configurations and available space. Variable ranges of aerodynamic acoustical splitter thicknesses and air passage dimensions are designed to turn the air efficiently and optimize acoustic performance.

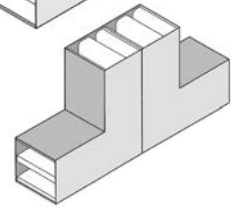

### 6. TD: Transitional Dissipative

Acoustical glass fiber is the primary sound-absorbing mechanism. Transitions integral to the silencers (in any plane) allow the silencers to optimally fit the duct system configurations. Variable ranges of aerodynamic acoustical splitter thicknesses and air passage dimensions optimize acoustic performance and energy conservation.

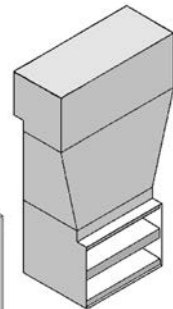

### TFL: Transitional Film Lined

Acoustical glass fiber is protected by a film liner such as Tedlar. Acoustical spacers between the perforated metal and films minimize acoustic performance degradation caused by the film.

Transitions integral to the silencers (in any plane) allow the silencers to optimally fit the duct system configurations. Variable ranges of aerodynamic acoustical splitter thicknesses and air passage dimensions optimize acoustic performance and energy conservation.

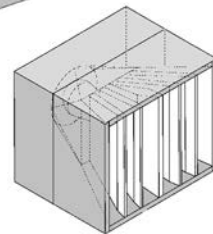
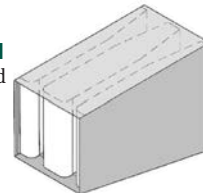

### TNM: Transitional No-Media

Silencers are void of glass fiber and any fill material whatsoever. The Helmholtz resonator mechanism is used as the primary sound reducing mechanism. Transitions integral to the silencers (in any plane) allow the silencers to optimally fit the duct system configurations. Variable ranges of aerodynamic acoustical splitter thicknesses and air passage dimensions optimize acoustic performance and energy conservation.

## SILENCERS

### 7. HTL: High Transmission Loss

HTL silencers add mass and/or stiffness to the silencer casing to reduce break-out or break-in noise. The materials are externally applied and completely sealed to the silencer casing in the factory.

HTL construction can be applied to ANY Vibro-Acoustics silencer type including Dissipative, Film Lined, No-Media, Elbow and Transitional Silencers. HTL construction can also be applied to, or replace standard ductwork.

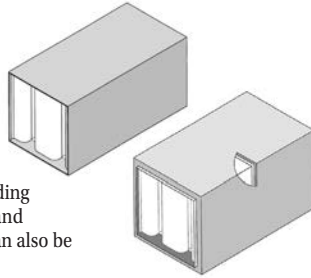

### 8. EX-RD / EX-RFL / EX-RNM: External Media Straight

The outside body dimensions are greater than the duct connection sizes. This permits larger air passages, lowering the pressure drop without reducing the acoustic performance or allows increased acoustic performance without increasing the pressure drop. Available as Dissipative, Film Lined or No-Media type.

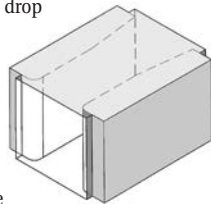

### EX-RED / EX-REFL / EX-RENM: External Media Elbow

The outside body dimensions are greater than the duct connection sizes. This permits larger air passages, lowering the pressure drop without reducing the acoustic performance or allows increased acoustic performance without increasing the pressure drop. Full 90 degree and/or a partial bends allow the silencers to fit the duct configurations and available space. Available as Dissipative, Film Lined or No-Media type.



### 9. RLP: Rectangular Low Pressure Drop

Thick (e.g. 4, 6, 8, 10 or 12") acoustical media, protected by perforated metal, or outboard expansion chambers on two, three or four walls allow the air passages to be the same size as the connecting ducts. Pressure drops are almost equal to that of empty ducts. May incorporate bends or notch-outs to match the duct systems and fit the available space. Available as Dissipative, Film Lined or No-Media type.

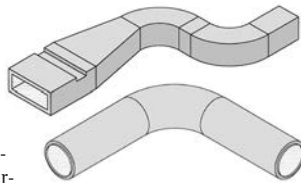

### CLP: Circular Low Pressure Drop

Thick (e.g. 4, 6, 8, 10 or 12") acoustical media, protected by perforated metal, or outboard expansion chambers over the entire circumference allow the air passages to be the same size as the connecting ducts. Pressure drops are almost equal to that of empty ducts. May incorporate bends or notch-outs to match the duct systems and fit the available space. Available as Dissipative, Film Lined or No-Media type.

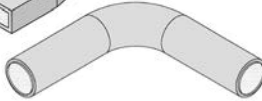

### 10. RSB: Rectangular Side Box

Aerodynamically and structurally designed to connect directly to a centrifugal fan's inlet and reduce distribution and swirl effects. They can also collect two or more return ducts. Constructions range from sheet metal for low pressure and heavier gauges for high pressure fans. Available as Dissipative, Film Lined or No-Media type.

### RDS: Rectangular Discharge Silencer

Aerodynamically and structurally designed to connect directly to a centrifugal fan's discharge. Accommodate high outlet velocities and unique flow profiles to minimize pressure drop. Constructions range from sheet metal for low pressure and heavier gauges for high pressure fans. Available as Dissipative, Film Lined or No-Media type.

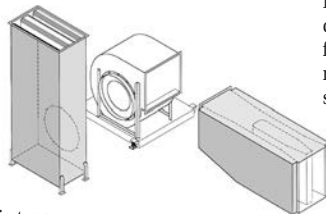

### 11. AC: Axial Cone

Aerodynamically and structurally designed to connect directly to an axial fan's inlet or discharge. Inlet AC silencers smoothly accelerate and direct the air onto the tips of the fan blades. Properly sized centerbodies help reduce the pressure losses at fan hubs.

Discharge AC silencers effectively decelerate the air to maximize the regain of static pressure. Properly sized centerbodies help reduce the turbulence and energy losses from fan motors. Available as Dissipative, Film Lined or No-Media type.

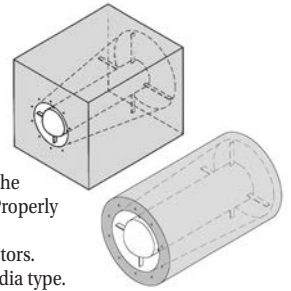

### 12. AP: Acoustical Plenum

Available as intake or discharge acoustical plenums to fans. Panel walls have thick (e.g. 4, 6 or 8") acoustical media or expansion chambers protected by perforated metal. Available as Dissipative, Film Lined or No-Media type.

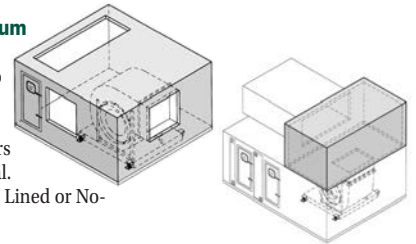

### 13. SRD: Short Rectangular Dissipative

Available in any length from 6" to 36" to fit behind architectural louvers or in air handling units. They use acoustical grade glass fiber as the principal sound-absorbing mechanism. Acoustical splitters, are used for broad-band attenuation. They vary in quantity and thickness, and air passages also vary in width. Splitters are aerodynamically shaped to minimize pressure drop.

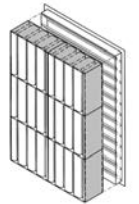

### 14. AL: Acoustical Louver

Designed to allow airflow through ventilation openings while reducing the radiation of noise. They use acoustical grade glass fiber as the principal sound-absorbing mechanism. Acoustical splitters, sometimes called vanes or splitter vanes, are used for mid to higher frequency attenuation. They vary in quantity and thickness, and air passages also vary in width. Lips are designed into the splitters to protect against weather elements.

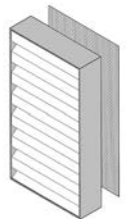

### 15. IAQ: Indoor Air Quality

Range from Dissipative to Film Lined to No-Media type depending on the specific application requirements. Access ports for in-situ cleaning, degreased materials and special packaging and factory cleaning are some of the options available.

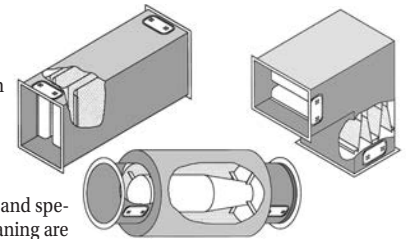

### 16. CT: Cross Talk

Designed to reduce speech intrusion into adjacent rooms via connecting ducts and return air openings. They use acoustical grade glass fiber as the principle sound-absorbing mechanism. Acoustical splitters, sometimes called baffles, are used for optimal mid-frequency range attenuation. Splitters vary in quantity and thickness, and air passages also vary in size.

