



**VERTICAL SINGLE AND DOUBLE WALL BELT DRIVE AIR HANDLER
DX OR CHILLED WATER
COOLING WITH HOT WATER OR
ELECTRIC HEAT**



•
All Technical Specifications are Subject to
Change without Notice. For more information
contact Customer Service Phone
(817)624.0820 Fax (817)624.8581

STANDARD FEATURES

CONSTRUCTION

- Single and Double wall post and panel construction from heavy gauge galvanized steel.
- 1" Insulation sandwiched between double wall galvanized panels.
- 1" foil faced insulation on single wall units.
- IAQ drain pan sloped 3-ways.
- Drain pans made from 304 stainless steel.
- Integral auxiliary drain pan.
- All cabinet parts are assembled with stainless steel hardware.

BLOWER ASSEMBLY

- Blower sections feature base mounted motors and adjustable motor bases for ease of service mounted on RIS isolators for quite vibration free operation.
- All blowers are mounted to 12-gauge support channels on rubber isolators.
- Blower exits cabinet through flexible rubber isolators.
- A discharge duct flange is provided.

FILTER SECTION

- 2" TA flat filters are single wall standard.
- Filter access from front only.

COIL SECTION

- "A" type coils on all models
- 3/8" O.D. seamless copper tube on sizes 24 and 36.
- 1/2" O.D. seamless copper tube on sizes 48 and 60.
- 5/8" O.D. seamless copper tube on sizes 90 and 120.
- Units can accept up to 6 rows of coil without modification.

STANDARD MOTORS

- ODP Motor is mounted to a 12 gauge adjustable base attached to the unit floor with rubber isolators
- 115/230v 1ph, 277v 1ph, 208/230/460v 3ph.
- All units are ETL listed.
- Consult factory for single phase motors mounting options.

OPTIONAL FEATURES

CONSTRUCTION

- Liner options include stainless steel, aluminum, or Anti-microbial coating. (double wall only)
- Stainless steel integral overflow pan.
- Powder coated cabinet.
- Pre-painted steel cabinet

FILTER SECTION

- Double wall filter section accepts 2" flat filters.
- 2" pleated (30%).

MIXING BOXES

- *MB3-** Mixing Box with 3 position Manual Control (None filtered)
- *MBM-** Mixing Box with Modulating Actuator Control (Non Filtered)
- *FMB3-** Filtered Mixing Box w/3position Manual Control (2" TA Filter)
- *FMBM-** Filtered Mixing Box w/ Mod. Act. Control (2" TA Filter)
- *MSS-** Motor Stop/Start Station
- VDP** Vertical Discharge Plenum
- VRG** Return Grill for Vertical Unit

ELECTRIC HEAT SECTION

- Factory Supplied for Field Mounting
- Reheat Configurations.
- Single point power connection.
- Custom staging and controls.
- Available Voltages: Single phase (115v, 230v, 277v)
Three phase (208v, 230v, 460v, 575v)

VFD'S - Variable Frequency Drives

Available for Field installation for motors bigger than 1 hp

COIL SECTION

- 2, 4, 6, row coil options
- Heating coils are factory installed in reheat positions.
- Steam coils-Low Pressure, less than 2 PSI.
- Optional tube diameters.
- Optional copper fin.
- Optional stainless steel end plates.
- Face split, row split, intertwined circuiting available.
- Automatic air vents.

MOTOR OPTIONS

- TEFC
- High efficient.
- 2-speed 2-winding.
- 575 volt

GUIDE SPECIFICATIONS

Unit Description:

Vertical belt drive with optional chilled water, hot water, steam or DX coils. Galvanized steel cabinet can be double or single wall construction. Unit designated to be installed on the floor in vertical position. Units have full service access from the front of the cabinet.

Quality Assurance:

Coils are factory tested under water at 500 psig for operating pressures to 400 psig. Insulation and adhesive shall meet the NFPA-90A standard for smoke and flame spread.

Delivery, Handling and Storage:

Units have to be stored and handled in accordance with equipment manufacturer's recommendations.

PRODUCTS

Equipment:

- A. Factory assembled, vertical, draw-thru blower coil units, for installation on the floor in vertical position. Units shall be complete with chilled or hot water, steam or DX coils, fans and motor, belt and drives, drain pan and filter rack to accept 2" TA filters.

Cabinet, Single wall:

- B. Post and panel construction shall be from heavy gauge galvanize steel, lined with 1" 1.5 lb density and 0.5" as an option fiber glass Thermal acoustical insulation 7/8" closed cell is offered as an option too. Units will mount on the floor with an optional stand factory or contractor manufactured. Supply and return flanges to be 1" long. Large removable access panels shall be on front of unit.

Cabinet, Double wall:

- C. Post and panel construction shall be from heavy gauge galvanize steel, lined with 1" 1.5 lb density fiber glass Thermal acoustical insulation, lined with smooth galvanized steel. Units will mount on the floor with an optional stand factory or contractor manufactured. Supply and return flanges to be 1" long. Large removable access panels shall be on front of unit.

Drain Pan:

- D. The primary shall be stainless steel and include a built in overflow pan with a 1" MPT secondary and a 1" MPT primary drain connection. Secondary drain shall be galvanized or stainless steel to prevent corrosion should an overflow occur.

Coil Section:

- E. All coils are "A" type coils on vertical units. Coils can have heating and cooling combinations up to 6 rows. Entire coil section cabinet shall be double wall lined with smooth galvanized steel for easy cleaning and coil removal.

Blowers:

- F. Belt Drive DWDI (double with, Double Inlet) fan wheel shall be forward curved blades and be factory statically and dynamically balanced. Blower's drives shall consist of cast iron variable pitch motor pulley and V-belt. Blowers and scrolls shall be manufactured from galvanized steel.

Coils:

- G. "A" Type coil tube diameters shall be 0.375", 0.50" or 0.625" OD copper tubes, aluminum fins mechanically bonded to the tubes and have a working pressure of 250 psig at 200 °F. Each water coil shall have manual air vents and sweat connections, which have to be accessible from the exterior of cabinet.

Motors:

- H. Motors shall be Open Type, Drip Proof, single or 2 speed, 60 Hz 1750 RPM, 1 or 3 phases, suitable for continuous duty at 130 °F; single phase motors are capacitor start, include automatic reset thermal over-load protection and are available in 115, 208, 230 and 277 volts. Three phase motors are available in 208, 230, 460 or 575 volts. Motors shall be resilient base mounted up to 2 hp. From 3 hp and up shall be rigid base mounted.

Electric Heat:

- I. Electric heat shall be designed to mount at the discharge air openings of the unit. Electric heat is factory supplied for field installation and shall include a de-energizing magnetic control contactor per stage with a capacity of 48 Amps per circuit and include a secondary over-temperature switch. Heaters shall include fan-interlocking, power and control terminal boards with grounding lugs. An automatic limit switch shall provide aver-temperature protection and a manual reset limit switch shall provide secondary over-temperature protection. Electric heat is factory supplied for field mounting.

Filters:

- J. Standard filter rack shall include 2" TA filters, with option for 2" pleated filters. Filter racks have to be accessible from the front of unit.



BELT DRIVE UNITS

CAP DESCRIPTION MODEL NUMBER NOMENCLATURE - PAGE #1

H	W	E	D	A	0	9	0	3	2	2	5	1	.	2	5	2	4	2	A	R	H	6	
MODEL				CM	SIZE			CFM			ESP		COIL ROWS			RF	CN	MOTOR					
UNIT CONFIGURATION H HORIZONTAL V VERTICAL M MODULAR R ROOFTOP											PRE-HEAT 0 NO PH 1 1-ROW 2 2-ROW												
COOLING OPTIONS W CHILLED WATER X DIRECT EXPANSION 0 NO COOLING											COOLING 0 NO COOLING 2 2-OWS 4 4-OWS 6 6-OWS 8 8-OWS												
HEATING OPTIONS H HOT WATER S STEAM E ELECTRIC O NO EAT											RE-HEAT 0 NO RH 1 1-ROW 2 2-ROW												
UNIT INSULATION S SINGLE WALL 1/2" FOIL FACE FIBERGLASS T SINGLE WALL 1" FOIL FACE FIBERGLASS U SINGLE WAL 7/8" CLOSED CELL D DOUBLE WALL X SPECIAL											REFRIGERANT A R-410A B R-22 C R-NU22 D R-134A 0 NONE												
CABINET MATERIAL A GALVANIZED STEEL B PRE-PAINTED STEEL C POWDER PAINTED											PIPING CONNECTIONS R RIGHT HAND L LEFT HAND ALL CONNECTIONS ARE SET LOOKING THE UNIT IN THE AIR FLOW DIRECTION												
UNIT SIZE 024 24000 036 36000 048 48000 060 60000 090 90000 120 120000 180 180000 240 240000											MOTOR HP AND VOLTAGE OPTIONS 1ST DIGIT A 0.25 B 0.33 C 0.50 D 0.75 E 1.00 F 1.50 G 2.00 H 3.00 I 5.00 J 7.50 K 10.0		2ND DIGIT 1 115/208/230/1 ODP 2 115/230/1 ODP, HE 3 115/1 ODP, 2 SPD 4 230/1 ODP, 2 SPD 5 277/1 ODP 6 208/230/460/3/50/60hz ODP 7 208/230/460/3/50/60hz ODP, HE 8 208/230/460/3/50/60 ODP, 2 SPD 9 575 V 3 Ph 60Hz										

CAP DESCRIPTION MODEL NUMBER NOMENCLATURE - PAGE #2

B	B	C	0	E	1	0	0	.	0	C	0	0	C	F	0	1	1
OA0	UNIT ACCS			V	EH KW				HTR ACCS			V	VFD ACCS	REV.		REV.	

FACTORY USE

OUTSIDE AIR OPTIONS

- O NONE
- A MIXING BOX W/ PLEATED FILTER 2"
- B MB W/ 3 POSITION CONTROL PACKAGE
- C MB W/MODULATING CONTROL PACKAGE
- E FACE & BYPASS DAMPER W/FILTER SEC.
- X SPECIAL

UNIT ACCESSORIES

- O NONE
- A PLEATED FILTER 2"
- B DISCHARGE GRILL PLENUM
- C RETURN GRILL AIR PLENUM
- E MOTOR START STOP STATION
- X SPECIAL

HEATER VOLTAGE

- O NO HEATERS
- A 115/1
- B 208/1
- C 230/1
- E 277/1
- F 208/3
- G 230/3
- H 460/3
- J 575/3

HEATER CAPACITY

1.0 to 100.0 KW IN .1 Kw increments

- O NO HEATERS

HEATER ACCESSORIES

- O NO ACCESSORIES
- A Single point line Conn.
- B SCR Controls
- C Start Stop Control St
- D None

VFD ACCESSORIES

- O NO ACCESSORIES
- A REM MTG KIT
- B LCP11 CONT PANEL
- C LCP12 CONT PANEL
- D NE/UL TY1 K FOR M1 FR
- E NE/UL TY1 K FOR M2 FR
- F NE/UL TY1 K FOR M3 FR
- G DECOUPLING PLT KIT FOR M1&M2 FRAME
- H DECOUPLING PLT KIT FOR M3 FRAME
- I IP21 FOR M1 FRAME
- J IP21 FOR M2 FRAME
- K IP21 FOR M3 FRAME
- L DIN RAIL MTG KIT

VFD SIZE

- O NO VFD
- A 0.25 HP 230/1
- B 0.50 HP 230/1
- C 1.00 HP 230/1
- D 2.00 HP 230/1
- E 3.00 HP 230/1
- F 0.33 HP 230/3
- G 0.50 HP230/3
- H 1.00 HP 230/3
- I 2.00 HP 230/3
- J 3.00 HP 230/3
- K 5.00 HP 230/3
- L 0.50 HP 460/3
- M 1.00 HP 460/3
- N 2.00 HP 460/3
- P 3.00 HP 460/3
- Q 5.00 HP 460/3
- R 7.50 HP 460/3
- S 10.0 HP 460/3

NOTE: MOST ACCESSORIES ARE NOT FACTORY INSTALLED, CONTACT FACTORY REP. FOR DETAILS

COIL DATA									
MODEL	FIN BLOCK	COIL TYPE	FACE	ROWS	FPI	WATER CONN.	DX CONN.		
	H X W		AREA			HEADER OD	SUCT	LIQ	
24-H	14 X 20	HW	1.94	1	10	5/8	N/A	N/A	
	14 X 20	HW	1.94	2			N/A	N/A	
	(2) 12 X 16	CW/DX	2.66	4		7/8	7/8	3/8	
36-H	14 X 20	HW	1.94	1		7/8	N/A	N/A	
	14 X 20	HW	1.94	2			N/A	N/A	
	(2) 12 X 16	CW/DX	3.00	4			7/8	3/8	
48-H	18 X 20	HW	2.50	1			7/8	N/A	N/A
	18 X 20	HW	2.50	2				N/A	N/A
	(2) 15 X 18	CW/DX	3.75	4				7/8	1/2
60-H	22.5 X 20	HW	3.47	1		1-1/8	N/A	N/A	
	22.5 X 20	HW	3.47	2		7/8	N/A	N/A	
	(2) 15 X 23	CW/DX	4.79	4			7/8	1/2	
90-H	39 X 22	HW	5.95	2	1-3/8	N/A	N/A		
	(2) 15 X 33	CW/DX	6.88	4	1-1/8	1-3/8	5/8		
120-H	43.5 X 22	HW	6.65	2	1-3/8	N/A	N/A		
	(2) 15 X 45	CW/DX	9.38	4	1-1/8	1-5/8	5/8		

For more information contact Customer Service

Phone: 817-624-0820 Fax: 817-624-8581

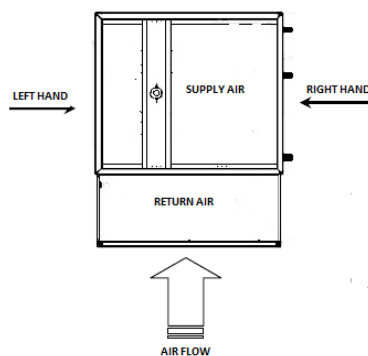

VERTICAL BELT DRIVE FILTER ARRANGEMENTS

SIZE 24 & 36 (2) **12 X 24 X 2**

SIZE 48 & 60 (3) **12 X 24 X 2**

SIZE 90 & 120 (4) 20X25X2



SIZE 24 & 36



SIZE 48 & 60



SIZE 90 & 120



SIZE 24 & 36



SIZE 48 & 60

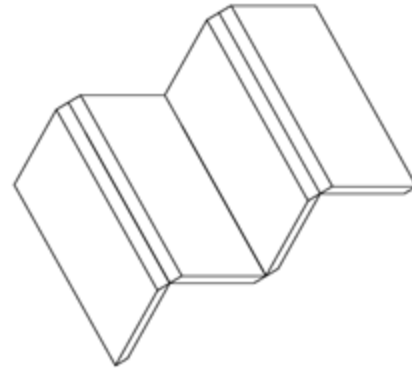

SIZE 90 & 120

All Technical Specifications Subject to Change Without Notice.
For more information contact Customer Service
Phone (817) 624.0820 Fax (817) 624.8581
www.commercialaire.com

UNIT DIMENSIONS SINGLE AND DOUBLE WALL

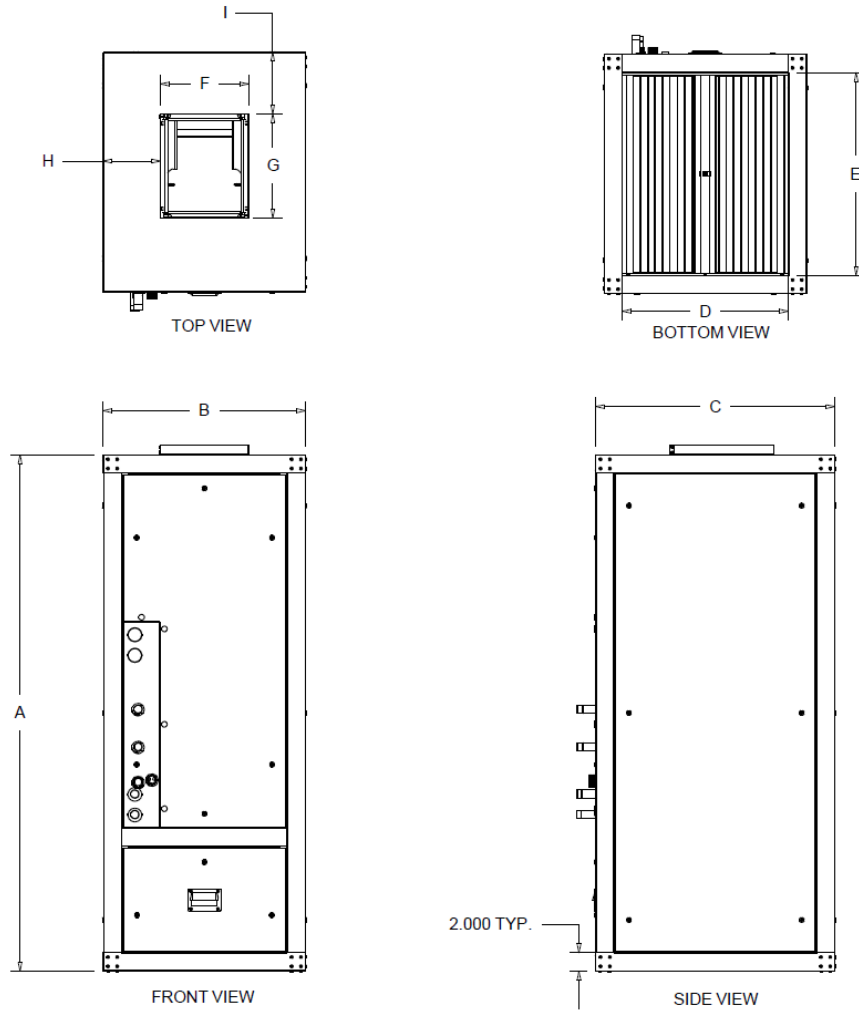

VERTICAL UNITS DIMENSIONS

Unit Model	A	B	C	D	E	F	G	H	I
VWD - 024	56.00	22.00	26.00	18.00	22.00	9.13	11.13	5.88	7.88
VWD - 036	56.00	22.00	26.00	18.00	22.00	12.69	11.13	5.88	7.88
VWD - 048	64.00	30.00	26.00	26.00	22.00	14.00	12.25	9.50	7.50
VWD - 060	64.00	30.00	26.00	26.00	22.00	16.50	14.50	7.50	5.50
VWD - 090	75.00	52.00	30.00	48.00	26.00	19.50	16.75	18.00	7.00
VWD - 120	75.00	52.00	30.00	48.00	26.00	19.50	16.75	18.00	7.00

All Technical Specifications Subject to Change Without Notice

For More Information Contact Customer Service

Phone (817) 624-0820 Fax (817) 624-8581

www.commercialaire.com

VERTICAL UNITS WEIGHT AND DISTRIBUTION BASED ON 6 ROW "A" TYPE COIL									
Unit Model	Corner weights 6 Row "A" Type Coil				Total Weight	Correction Factors for Rows and Single Wall			
	A	B	C	D		4R	2R	Single Wall	
VWD - 024	55	58	54	52	219	-20	-28	-35	
VWD - 036	58	61	56	54	229	-27	-39	-35	
VWD - 048	72	83	67	74	296	-35	-50	-40	
VWD - 060	77	85	69	76	307	-45	-65	-40	
VWD - 090	98	108	102	101	409	-72	-103	-65	
VWD - 120	107	113	105	102	427	-95	-140	-65	

TOP VIEW

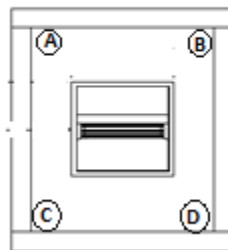

SUPPLY AIR PLENUM WITH ADJUSTABLE FOUR WAY GRILL

Notes:

- The drawings and dimensions on this page are for illustration purpose
- Consult factory for final drawings for construction
- Units with supply air plenum cannot have electric heat
- Units with return air plenum cannot have mixing box, no face & by pass dampers
- Supply and return air plenums are made with heavy gauge galvanized steel

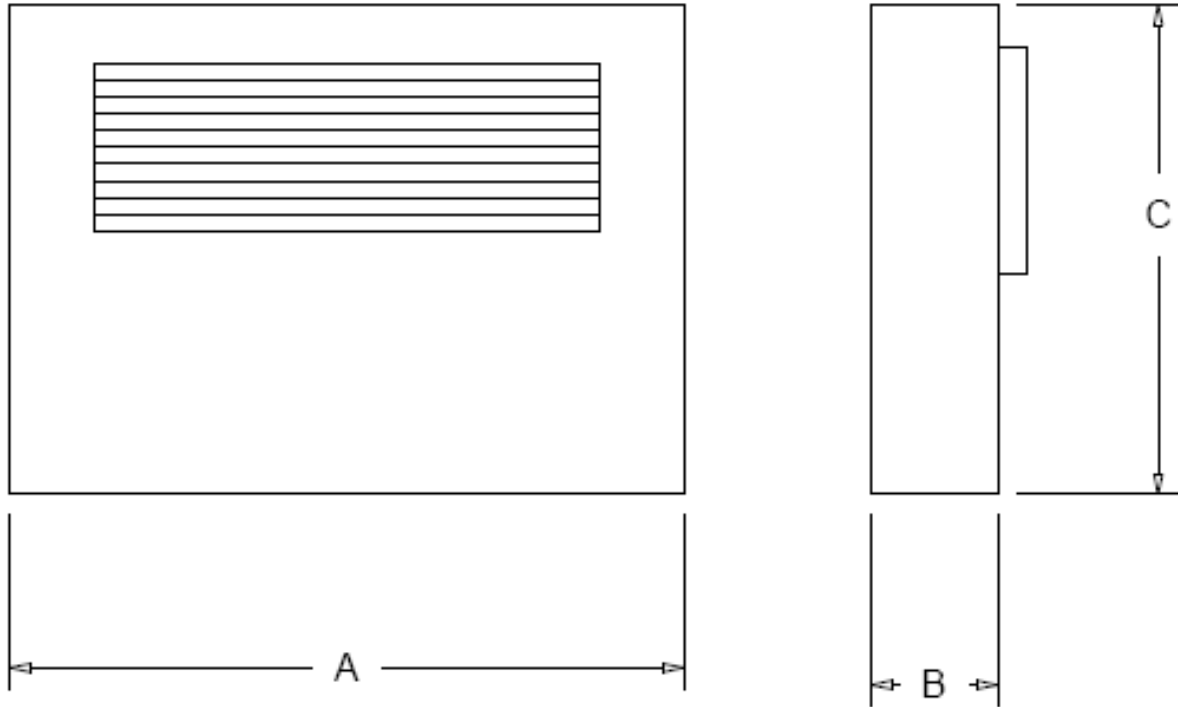

MODEL	A	B	C	GRILL
VWSP - 024/036	22.0	26.0	20.0	12 X 20 4-W
VWSP - 048/060	30.0	26.0	20.0	16 X 24 4-W
VSWP - 090/120	52.0	30.0	20.0	18 X 48 4-W
ALL DIMENSIONS SHOWN ARE APROXIMATE AND ROUNDED, SUBJECT TO CHANGE WITHOUT NOTICE				

RETURN AIR PLENUM UNITS WITH FIX RETURN GRILL

Notes:

- The drawings and dimensions on this page are for illustration purpose
- Consult factory for final drawings for construction
- Units with supply air plenum cannot have electric heat
- Units with return air plenum cannot have mixing box, no face & by pass dampers
- Supply and return air plenums are made with heavy gauge galvanized steel

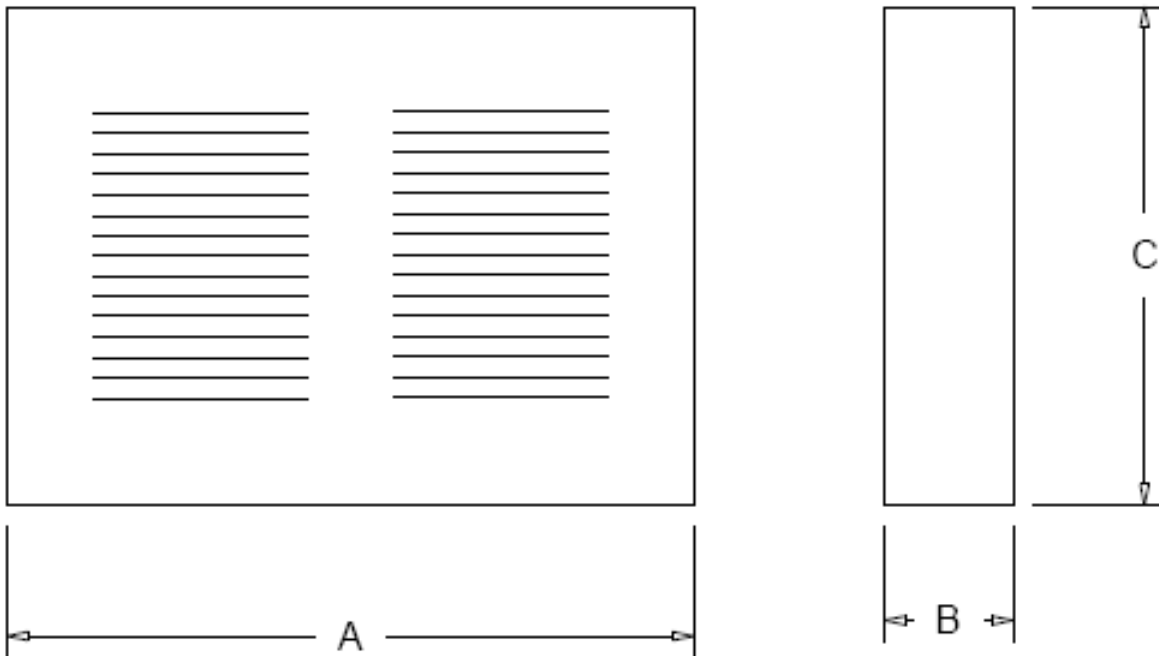

MODEL	A	B	C
VWRT - 024/036	22.0	26.0	20.0
VWRT - 048/060	30.0	26.0	20.0
VWRT - 090/120	52.0	30.0	20.0
ALL DIMENSIONS SHOWN ARE APROXIMATE AND ROUNDED, SUBJECT TO CHANGE WITHOUT NOTICE			

FACE & BY-PASS DAMPER FOR SIZE 024 TO 120

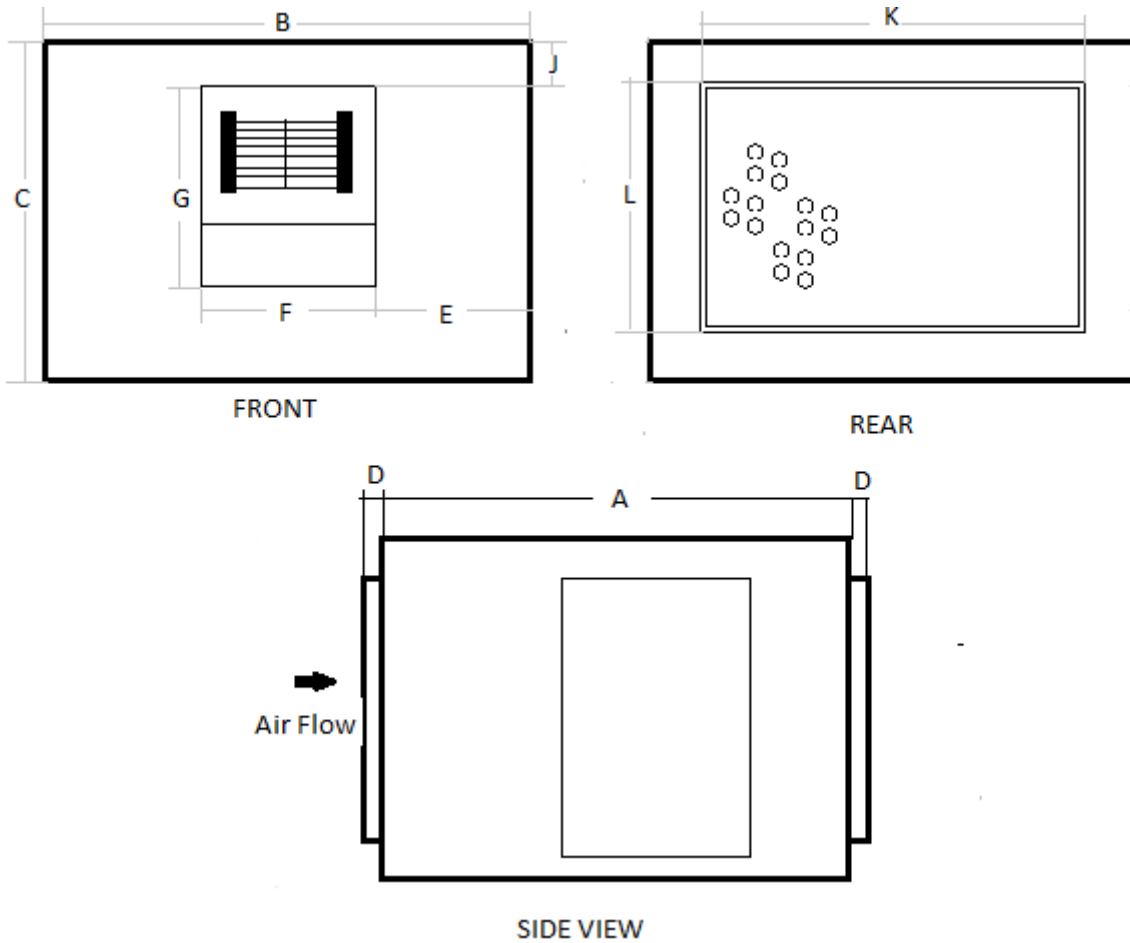

DIMENSIONS

MODEL		A	B	C	D	E	F	G	J	K	L
VFBPD	- 024/036	26.00	22.00	25.00	0.75	6.50	18.00	15.25	3.00	15.00	16.50
VFBPD	- 048/060	26.00	30.00	30.00	0.75	6.50	18.00	15.25	3.00	23.00	22.50
VFBPD	- 090/120	30.00	52.00	35.00	0.75	6.50	18.00	15.25	3.00	45.00	26.50

ALL DIMENSIONS SHOWN ARE APPROXIMATE AND ROUNDED, SUBJECT TO CHANGE WITHOUT NOTICE

MIXING BOX FOR SIZE 024 TO 120

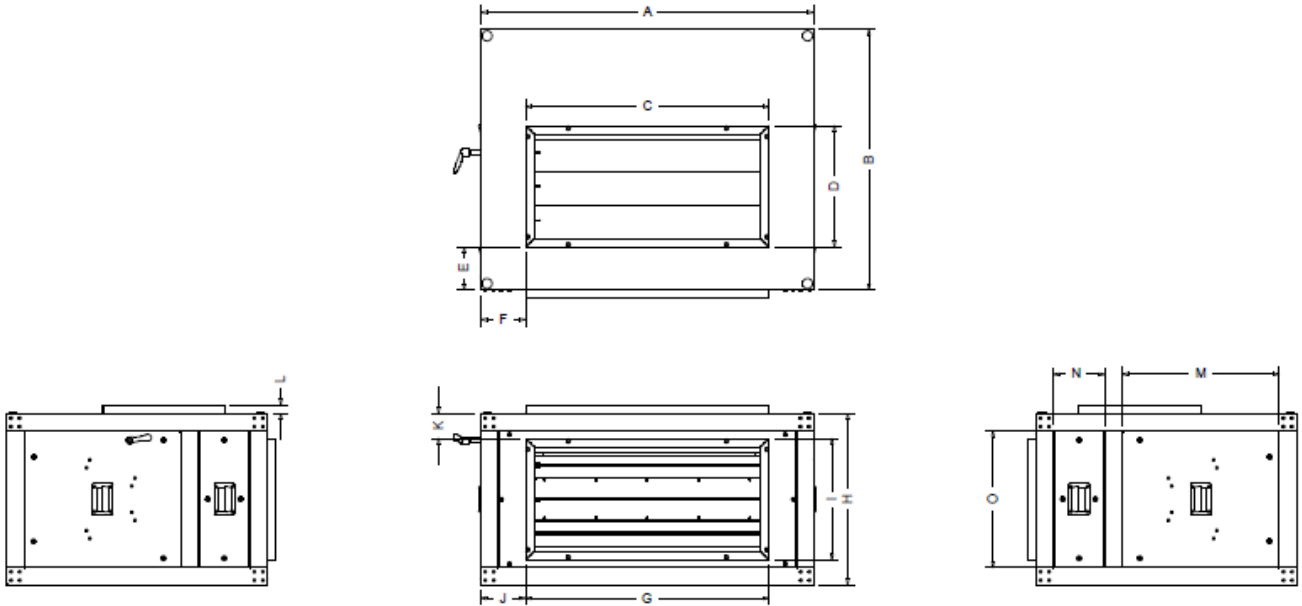

DIMENSIONS

UNIT	A	B	C	D	E	F	G	H	I	J	K	L	M	N	O
VWMB3 - 024	22.0	26.0	16.5	15.0	5.0	2.25	19.5	25.0	14.5	3.25	5.25	1.0	12.5	6.0	20.0
VWMB3 - 036	22.0	26.0	16.5	15.0	5.0	2.25	19.5	25.0	14.5	3.25	5.25	1.0	12.5	6.0	20.0
VWMB3 - 048	30.0	34.0	22.5	23.0	5.0	3.75	27.5	30.0	17.5	3.25	6.25	1.0	12.5	6.0	25.0
VWMB3 - 060	30.0	34.0	22.5	23.0	5.0	3.75	27.5	30.0	17.5	3.25	6.25	1.0	12.5	6.0	25.0
VWMB3 - 090	52.0	52.0	39.5	45.0	5.0	6.25	45.5	35.0	22.5	3.25	6.25	1.0	16.5	6.0	30.0
VWMB3 - 120	52.0	52.0	39.5	45.0	5.0	6.25	45.5	35.0	22.5	3.25	6.25	1.0	16.5	6.0	30.0



STANDARD RATINGS – 4 ROW CHILLED WATER COIL																					
Model	EWT	cfm	2- or 4-Pipe Cooling																		LWT
			85 °F DB / 71°F WB						80 °F DB / 67°F WB						75 °F DB / 63°F WB						
			GPM	PD Ft.	TTL MBH	SENS MBH	LAT DB	LAT WB	GPM	PD Ft.	TTL MBH	SENS MBH	LAT DB	LAT WB	GPM	PD Ft.	TTL MBH	SENS MBH	LAT DB	LAT WB	
VW*D024	45	600	4.0	2.4	27.8	17.0	57.6	55.8	2.7	1.2	20.8	14.6	56.8	54.9	2.7	1.2	14.0	11.9	56.2	54.3	55
		800	5.7	2.6	32.8	20.8	59.9	57.8	3.2	1.6	24.7	18	58.5	56.3	3.2	1.6	16.7	14.8	57.4	55.2	
		1000	6.4	3.1	36.9	24.2	61.7	59.2	3.6	2.0	27.9	21	59.9	57.4	3.6	2	20.7	18.1	57.8	55.3	
VW*D036	45	900	6.9	3.8	39.9	24.1	59.1	57.0	3.8	2.3	28.8	20.6	58.1	55.9	3.8	2.3	19.5	17.0	57.1	54.9	55
		1200	8.0	4.9	45.5	29.3	61.4	58.8	4.4	1.9	33.8	25.2	59.9	57.3	4.4	1.9	25	21.7	57.9	55.2	
		1500	8.9	6.2	50.0	33.6	63.4	60.4	5.1	2.4	38.0	29.3	61.3	58.3	5.1	2.4	28.6	25.5	58.9	55.9	
VW*D048	45	1200	11.6	5.2	59.5	38.0	58.8	57.2	6.3	1.6	36.4	31.9	56.8	55.8	6.3	1.6	32.6	28.1	56.0	54.3	55
		1600	12.6	6.0	64.7	42.0	59.7	58.0	6.9	1.9	48.6	36.3	58.2	56.5	6.9	1.9	35.6	31.3	56.5	54.7	
		2000	13.6	6.9	69.6	46.0	60.4	58.6	7.5	2.1	53.8	41.1	59.2	57.3	7.5	2.1	38.5	34.4	56.9	55.0	
VW*D060	45	1500	14.4	8.5	78.5	49.6	58.4	56.8	7.9	2.7	58.4	41.8	57.1	55.3	7.9	2.7	43.3	36.6	56.1	54.4	55
		2000	15.4	7.0	83.8	53.6	59.1	57.4	8.4	3.4	63.3	46.5	57.8	56	8.4	3.4	46.2	39.8	56.1	54.4	
		2500	16.3	7.7	89.1	57.7	59.7	57.9	9.0	3.8	69.2	52.1	58.7	56.9	9.0	3.8	49.4	43.0	56.5	54.6	
VW*D090	45	2250	20.8	19.5	115.7	72.4	57.0	55.9	11.4	11.7	85.9	65.8	55.6	54.3	11.4	11.7	64.3	53.6	54.7	53.4	55
		3000	23.3	23.9	129.9	83.3	58.2	56.9	12.9	14.7	98.3	72.3	57	55.6	12.9	14.7	72.5	62.2	55.4	54.0	
		3750	25.7	19.7	142.7	93.6	59.2	57.8	14.3	17.8	110.3	83.6	58.4	56.9	14.3	17.8	80.0	70.4	56.0	54.5	
VW*D120	45	3000	25.4	22.7	149.5	91.1	55.7	54.5	13.9	18.3	113.7	78.6	54.9	53.7	13.9	18.3	83.4	67.0	53.9	52.6	55
		4000	30.5	30.5	180.3	113.7	56.7	56.3	16.8	15.1	136.9	98.6	56.4	55.1	16.8	15.1	100.8	84.3	55.0	53.6	
		5000	34.9	39.1	206.8	134.5	53.0	57.6	19.4	19.5	157.4	117.3	57.6	56.1	19.4	19.5	116.2	101.0	55.9	54.3	

STANDARD RATINGS HOT WATER COIL														
MODEL	cfm	2-Pipe Heating 2 Row Coil								2-Pipe Heating 1 Row Coil				LWT
		60 °F EAT / 180 °F EWT				50 °F EAT / 180 °F EWT				60 °F EAT / 180 °F EWT				
		GPM	PD Ft.	TTL MBH	LAT	GPM	PD Ft.	TTL MBH	LAT	GPM	PD Ft.	TTL MBH	LAT	
VW*D024	600	3.4	1.9	33.0	110.7	3.8	2.4	37.0	106	1.7	0.5	16.7	85.6	160
	800	4.1	1.1	39.8	105.8	4.6	1.4	44.5	100	2	0.7	19.6	82.5	
	1000	4.7	1.5	45.6	102.0	5.2	1.9	51.1	96.2	2.3	0.8	22.0	80.3	
VW*D036	900	4.4	1.3	42.8	103.8	4.9	1.6	47.9	98.1	2.1	0.8	20.8	89.3	160
	1200	5.2	1.8	50.8	99.0	5.8	2.3	56.9	92.9	2.5	1.0	24.2	78.5	
	1500	5.9	2.4	57.7	95.4	6.6	3.0	64.6	88.9	2.8	1.3	26.9	76.5	
VW*D048	1200	6.4	2.7	62.9	101.4	7.3	3.4	70.8	95.7	2.9	1.4	28.4	78.7	160
	1600	7.0	3.1	67.9	99.1	7.8	3.9	76.5	93.2	3.1	1.6	30.2	77.4	
	2000	7.4	3.5	72.6	97.1	8.4	4.2	81.8	91.0	3.3	1.7	31.9	76.3	
VW*D060	1500	8.3	1.0	80.8	101.4	9.3	1.3	91.0	95.7	3.7	2.1	36.5	78.7	160
	2000	8.8	1.1	85.9	99.6	9.9	1.4	96.8	93.7	3.9	2.3	38.4	77.7	
	2500	9.3	1.3	90.7	98.0	10.5	1.6	102.2	92.0	4.1	1.0	40.1	76.8	
VW*D090	2250	12.8	3.9	130.5	109.8	15.7	2.1	152.7	105	6.4	2.1	63.5	83.2	160
	3000	15.4	2.0	150.0	106.1	17.4	2.6	169.5	101.0	7.6	2.3	73.6	81.8	
	3750	18.2	2.5	165.2	102.5	18.9	3.0	184.4	97.6	9.1	2.4	78.2	79.6	
VW*D120	3000	16.1	2.1	157.4	108.3	18.2	2.7	177.7	104	8.0	2.0	71.5	87.6	160
	4000	18.9	2.9	184.4	102.5	21.4	3.7	208.4	97.1	9.5	2.7	79.2	85.4	
	5000	21.2	3.7	206.1	98.1	24	4.7	253.7	92.2	11.0	3.5	88.4	83.6	

PRESSURE DROP FOR VERTICAL AHU FILTERS

Throwaway						
Model	CFM	Filter Size & Qty.	Total Filter Area	Face Velocity FPM	2" Filter PD	4" Filter PD
24	600	(2) 12X24	4.00	150.00	0.051	0.075
	700			175.00	0.059	0.088
	800			200.00	0.067	0.101
	900			225.00	0.076	0.113
	1000			250.00	0.084	0.126
36	900	(2) 12X24	4.00	225.00	0.076	0.113
	1050			262.50	0.089	0.132
	1200			300.00	0.101	0.151
	1350			337.50	0.114	0.170
	1500			375.00	0.126	0.189
48	1200	(3) 12X24	6.00	200.00	0.067	0.101
	1400			233.33	0.079	0.117
	1600			266.67	0.090	0.134
	1800			300.00	0.101	0.151
	2000			333.33	0.112	0.168
60	1500	(3) 12X24	6.00	250.00	0.084	0.126
	1750			291.67	0.098	0.147
	2000			333.33	0.112	0.168
	2250			375.00	0.126	0.189
	2500			416.67	0.141	0.210
90	2250	(4) 20X25	13.89	161.99	0.055	0.081
	2625			188.98	0.064	0.095
	3000			215.98	0.073	0.109
	3375			242.98	0.082	0.122
	3750			269.98	0.091	0.136
120	3000	(4) 20X25	13.89	215.98	0.073	0.109
	3500			251.98	0.085	0.127
	4000			287.98	0.097	0.145
	4500			323.97	0.109	0.163
	5000			359.97	0.121	0.181

PRESSURE DROP FOR VERTICAL AHU FILTERS

Pleated						
Model	CFM	Filter Size & Qty.	Total Filter Area	Face Velocity FPM	2" Filter PD	4" Filter PD
24	600	(2) 12X24	4.00	150.00	0.075	0.084
	700			175.00	0.088	0.098
	800			200.00	0.101	0.112
	900			225.00	0.113	0.126
	1000			250.00	0.126	0.141
36	900	(2) 12X24	4.00	225.00	0.113	0.126
	1050			262.50	0.132	0.148
	1200			300.00	0.151	0.169
	1350			337.50	0.170	0.190
	1500			375.00	0.189	0.211
48	1200	(3) 12X24	6.00	200.00	0.101	0.112
	1400			233.33	0.117	0.131
	1600			266.67	0.134	0.150
	1800			300.00	0.151	0.169
	2000			333.33	0.168	0.187
60	1500	(3) 12X24	6.00	250.00	0.126	0.141
	1750			291.67	0.147	0.164
	2000			333.33	0.168	0.187
	2250			375.00	0.189	0.211
	2500			416.67	0.210	0.234
90	2250	(4) 20X25	13.89	161.99	0.081	0.091
	2625			188.98	0.095	0.106
	3000			215.98	0.109	0.121
	3375			242.98	0.122	0.137
	3750			269.98	0.136	0.152
120	3000	(4) 20X25	13.89	215.98	0.109	0.121
	3500			251.98	0.127	0.142
	4000			287.98	0.145	0.162
	4500			323.97	0.163	0.182
	5000			359.97	0.181	0.202

INTERNAL STATIC PRESSURES FILTERS, DX, CHILLED AND HOT WATER COIL

Air Volume Capacity - 4-Pipe, 4-Row Cooling and 2-Row Heating Coils							
	CFM	FV	1 ROW CW ISP	2 ROW CW ISP	4 ROW CW ISP	4 ROW DX ISP	TSP
24	600	225	0.03	0.06	0.13	0.13	
	700	257	0.04	0.08	0.17	0.17	
	800	300	0.05	0.10	0.21	0.21	
	900	332	0.06	0.13	0.25	0.25	
	1000	375	0.07	0.15	0.30	0.30	
36	900	300	0.06	0.12	0.21	0.21	
	1050	317	0.07	0.10	0.22	0.22	
	1200	400	0.10	0.20	0.34	0.34	
	1350	450	0.13	0.25	0.42	0.42	
48	1500	500	0.15	0.30	0.49	0.49	
	1200	288	0.05	0.07	0.26	0.26	
	1400	350	0.12	0.23	0.35	0.35	
	1600	400	0.19	0.38	0.44	0.44	
	1800	450	0.28	0.55	0.54	0.54	
60	2000	500	0.37	0.72	0.64	0.64	
	1500	313	0.06	0.10	0.29	0.29	
	1750	352	0.11	0.22	0.36	0.36	
	2000	391	0.18	0.36	0.43	0.43	
	2250	430	0.21	0.42	0.50	0.50	
90	2500	469	0.24	0.48	0.57	0.57	
	2250	304	0.08	0.17	0.48	0.48	
	2625	350	0.11	0.21	0.50	0.50	
	3000	396	0.12	0.26	0.63	0.54	
	3375	442	0.14	0.29	0.71	0.69	
120	3750	488	0.16	0.35	0.81	0.80	
	3000	291	0.06	0.21	0.40	0.36	
	3500	389	0.10	0.30	0.51	0.45	
	4000	387	0.12	0.38	0.61	0.53	
	4500	433	0.14	0.35	0.72	0.64	
	5000	484	0.17	0.51	0.82	0.74	

Internal Static Pressure Calculation

Select a Unit and Approximate CFM from the two left columns- Select the total number of rows and filter- Add filter to coil static pressure to obtain total ISP (internal static pressure) – Add the ISP to ESP for the system to obtain TSP (total static pressure)



BLOWER PERFORMANCE TABLES

Air Volume Capacity - 2-Pipe, 4-Row Coil														
Model	Internal SP	cfm	0.25" ESP		0.50" ESP		0.75" ESP		1.00" ESP		1.25" ESP		1.50" ESP	
			RPM	BHP	RPM	BHP	RPM	BHP	RPM	BHP	RPM	BHP	RPM	BHP
VW*D024	.18	600	864	0.12	998	0.17	1144	0.24	1288	0.32	1424	0.41	1549	0.49
	.23	700	966	0.18	1073	0.22	1193	0.29	1318	0.37	1443	0.46	1564	0.56
	.28	800	866	0.17	1025	0.22	1152	0.28	1267	0.34	1374	0.41	1475	0.47
	.34	900	955	0.22	1084	0.28	1202	0.35	1312	0.41	1415	0.48	1511	0.55
	.39	1000	1143	0.35	1143	0.35	1255	0.42	1359	0.49	1457	0.57	1550	0.64
VW*D036	.29	900	1002	0.24	1416	0.48	1243	0.37	1350	0.44	1450	0.51	1545	0.60
	.27	1050	905	0.25	1195	0.40	1494	0.63	1403	0.55	1498	0.63	1575	0.70
	.44	1200	1041	0.33	1165	0.41	1281	0.50	1391	0.59	1551	0.77	1711	0.90
	.53	1350	1103	0.42	1219	0.50	1328	0.60	1431	0.69	1529	0.80	1745	1.00
	.62	1500	1166	0.52	1274	0.61	1377	0.71	1474	0.82	1568	0.93	1775	1.20
VW*D048	.33	1200	988	0.30	1102	0.37	1222	0.45	1335	0.54	1441	0.60	1550	0.70
	.43	1400	1047	0.39	1165	0.48	1276	0.55	1381	0.67	1480	0.80	1580	0.90
	.53	1600	1126	0.53	1235	0.62	1337	0.72	1434	0.83	1527	0.90	1628	1.00
	.64	1800	952	0.54	1054	0.65	1151	0.76	1244	0.88	1333	1.00	1426	1.10
	.75	2000	1013	0.69	1108	0.80	1198	0.92	1285	1.05	1369	1.20	1456	1.30
VW*D060	.31	1500	848	0.35	966	0.45	1076	0.55	1181	0.66	1281	0.78	1380	0.90
	.47	1750	905	0.48	1011	0.58	1112	0.69	1207	0.81	1299	0.93	1385	1.00
	.63	2000	973	0.64	1070	0.76	1162	0.87	1126	1.01	1335	1.13	1440	1.20
	.72	2250	1044	0.84	1133	0.97	1218	1.10	1300	1.23	1379	1.37	1475	1.30
	.81	2500	1115	1.08	1198	1.22	1277	1.36	1354	1.51	1427	1.65	1525	1.90
VW*D090	.38	2250	801	0.64	910	0.79	1011	0.95	1103	1.10	1187	1.27	1260	1.50
	.54	2625	862	0.90	956	1.06	1049	1.23	1137	1.41	1220	1.60	1305	1.80
	.70	3000	933	1.24	1014	1.41	1096	1.59	1178	1.79	1257	1.99	1337	2.20
	.86	3375	1012	1.66	1082	1.84	1154	2.04	1228	2.25	1300	2.47	1383	2.70
	.99	3750	1094	2.18	1155	2.38	1218	2.58	1284	2.80	1350	3.03	1465	3.20
VW*D120	.47	3000	646	0.76	718	0.90	785	1.05	849	1.20	910	1.36	970	1.60
	.59	3500	705	1.09	769	1.25	831	1.41	889	1.58	945	1.76	1000	2.00
	.71	4000	765	1.50	824	1.68	881	1.87	934	2.05	986	2.25	1012	2.50
	.83	4500	830	2.02	884	2.22	936	2.43	986	2.64	1034	2.85	1082	3.20
	.94	5000	898	2.66	948	2.89	995	3.11	1042	3.34	1087	3.57	1132	3.90



BLOWER PERFORMANCE TABLES

Air Volume Capacity - 4-Pipe, 4-Row Cooling and 2-Row Heating Coils														
Model	Internal SP	cfm	0.25" ESP		0.50" ESP		0.75" ESP		1.00" ESP		1.25" ESP		1.50" ESP	
			RPM	BHP	RPM	BHP	RPM	BHP	RPM	BHP	RPM	BHP	RPM	BHP
VW*D024	.24	600	731	0.07	890	0.11	1088	0.18	1209	0.23	1321	0.28	1440	0.37
	.31	700	754	0.10	761	0.13	1142	0.24	1253	0.28	1359	0.33	1458	0.39
	.38	800	878	0.13	980	0.18	1165	0.25	1303	0.35	1402	0.41	1496	0.46
	.46	900	930	0.16	1023	0.23	1218	0.30	1358	0.42	1496	0.50	1541	0.55
	.54	1000	981	0.20	1069	0.29	1269	0.37	1372	0.46	1596	0.55	1691	0.62
VW*D036	.41	900	715	0.14	823	0.19	917	0.24	1238	0.31	1333	0.36	1415	0.42
	.52	1050	781	0.20	882	0.25	971	0.31	1051	0.37	1123	0.42	1195	0.49
	.64	1200	847	0.27	942	0.33	1026	0.39	1104	0.46	1176	0.52	1243	0.59
	.78	1350	918	0.36	1006	0.42	1086	0.49	1161	0.56	1230	0.64	1295	0.71
	.92	1500	986	0.46	1069	0.53	1145	0.61	1216	0.69	1282	0.76	1345	0.84
VW*D048	.54	1200	806	0.24	905	0.30	993	0.37	1074	0.43	1147	0.50	1216	0.56
	.81	1400	876	0.38	1022	0.45	1101	0.53	1174	0.60	1243	0.67	1307	0.75
	1.08	1600	981	0.54	1129	0.64	1202	0.72	1270	0.80	1334	0.88	1394	0.97
	1.19	1800	1025	0.67	1184	0.79	1254	0.88	1320	0.97	1382	1.07	1442	1.16
	1.29	2000	1081	0.83	1143	0.92	1304	1.07	1368	1.17	1428	1.27	1486	1.37
VW*D060	.42	1500	749	0.27	821	0.36	1010	0.48	1069	0.53	1145	0.61	1216	0.69
	.69	1750	888	0.44	936	0.54	1024	0.65	1179	0.76	1249	0.85	1315	0.94
	.99	2000	1020	0.66	1049	0.78	1128	0.90	1202	1.02	1355	1.15	1417	1.25
	1.14	2250	1078	0.84	1175	0.98	1181	1.12	1251	1.25	1318	1.38	1480	1.55
	1.29	2500	1136	1.06	1224	1.20	1311	1.36	1321	1.51	1365	1.65	1439	1.86
VW*D090	.49	2250	604	0.44	702	0.59	776	0.73	868	0.89	931	1.04	981	1.17
	.54	2625	627	0.57	719	0.71	802	0.89	925	1.07	1002	1.23	1025	1.43
	.96	3000	775	0.96	857	1.18	923	1.35	980	1.56	1036	1.74	1091	1.93
	1.16	3375	837	1.28	908	1.47	979	1.72	1038	1.92	1095	2.13	1039	2.37
	1.36	3750	896	1.65	961	1.86	1025	2.07	1089	2.36	1162	2.78	1193	2.82
VW*D120	.68	3000	683	0.78	765	0.94	845	1.12	916	1.33	973	1.54	1030	1.72
	.88	3500	758	1.14	829	1.33	899	1.52	968	1.72	1033	1.98	1089	2.19
	1.09	4000	831	1.59	895	1.80	957	2.01	1018	2.23	1078	2.46	1142	2.78
	1.28	4500	897	2.12	956	2.35	1011	2.58	1066	2.82	1121	3.06	1175	3.31
	1.46	5000	959	2.73	1012	2.98	1063	3.23	1114	3.49	1164	3.75	1213	4.02



(R-410A) Cooling Capacity VX*D-024, 036, 048

2 Ton - 4 Row DX Coil						
85°F EDB / 71°F EWB						
CFM	Suction Temp.	APD FV	Total Capacity	Sensible Capacity	Leaving Air Temp.	
					DB °F	WB °F
600	35°F	0.18	57,381	32,332	35.2	34.8
	40°F		51,047	28,935	40.4	40.0
	45°F		44,248	25,604	45.5	45.0
	50°F		37,004	22,304	50.6	50.1
800	35°F	0.27	71,670	40,348	38.3	37.9
	40°F		63,505	36,172	43.2	42.8
	45°F		54,797	32,107	47.9	47.4
	50°F		45,620	28,087	52.5	52.0
1000	35°F	0.40	83,871	47,278	41.3	40.9
	40°F		74,061	42,490	45.7	45.2
	45°F		63,659	37,678	50.1	49.6
	50°F		52,799	33,234	54.3	53.8

2 Ton - 4 Row DX Coil						
80°F EDB / 67°F EWB						
CFM	Suction Temp.	APD FV	Total Capacity	Sensible Capacity	Leaving Air Temp.	
					DB °F	WB °F
600	35°F	0.18	48,758	29,113	35.1	34.7
	40°F		42,501	25,754	40.3	39.9
	45°F		35,792	22,459	45.4	44.9
	50°F		28,639	19,188	50.4	49.9
800	35°F	0.27	60,900	36,452	37.9	37.5
	40°F		52,873	32,311	42.6	42.2
	45°F		44,324	28,276	47.3	46.8
	50°F		35,307	24,280	51.9	51.4
1000	35°F	0.40	71,268	42,840	40.4	40.0
	40°F		61,662	38,073	44.8	44.4
	45°F		51,492	33,452	49.1	48.6
	50°F		40,863	28,856	53.3	52.8

2 Ton - 4 Row DX Coil						
77°F EDB / 64°F EWB						
CFM	Suction Temp.	APD FV	Total Capacity	Sensible Capacity	Leaving Air Temp.	
					DB °F	WB °F
600	35°F	0.18	42,768	27,179	35.1	34.7
	40°F		36,563	23,846	40.2	39.8
	45°F		29,916	20,577	45.3	44.8
	50°F		22,827	17,326	50.3	49.8
800	35°F	0.27	53,418	34,146	37.5	37.1
	40°F		45,486	30,029	42.3	41.9
	45°F		37,048	26,015	46.9	46.4
	50°F		28,142	22,036	51.5	51.0
1000	35°F	0.40	62,512	40,254	39.8	39.4
	40°F		53,047	35,504	44.2	43.8
	45°F		43,040	30,893	48.4	47.9
	50°F		32,570	26,312	52.7	52.2

3 Ton - 4 Row DX Coil						
85°F EDB / 71°F EWB						
CFM	Suction Temp.	APD FV	Total Capacity	Sensible Capacity	Leaving Air Temp.	
					DB °F	WB °F
900	35°F	0.27	80,629	45,391	38.3	37.9
	40°F		71,443	40,693	43.2	42.8
	45°F		61,646	36,120	47.9	47.4
	50°F		51,323	31,598	52.5	52.0
1200	35°F	0.45	98,492	55,571	42.2	41.8
	40°F		86,883	49,989	46.5	46.0
	45°F		74,593	44,382	50.8	50.3
	50°F		61,800	39,189	54.8	54.3
1500	35°F	0.64	113,246	64,258	45.4	44.9
	40°F		99,535	58,032	49.2	48.7
	45°F		85,111	51,732	53.1	52.6
	50°F		70,240	45,872	56.7	56.1

3 Ton - 4 Row DX Coil						
80°F EDB / 67°F EWB						
CFM	Suction Temp.	APD FV	Total Capacity	Sensible Capacity	Leaving Air Temp.	
					DB °F	WB °F
900	35°F	0.27	68,513	41,009	37.9	37.5
	40°F		59,482	36,350	42.6	42.2
	45°F		49,865	31,810	47.3	46.8
	50°F		39,721	27,315	51.9	51.4
1200	35°F	0.45	83,692	50,399	41.2	40.8
	40°F		72,337	44,834	45.4	44.9
	45°F		60,337	39,447	49.6	49.1
	50°F		47,829	34,073	53.7	53.2
1500	35°F	0.64	96,229	58,453	44.0	43.6
	40°F		82,871	52,206	47.8	47.3
	45°F		68,845	45,911	51.7	51.2
	50°F		54,362	40,078	55.3	54.7

3 Ton - 4 Row DX Coil						
77°F EDB / 64°F EWB						
CFM	Suction Temp.	APD FV	Total Capacity	Sensible Capacity	Leaving Air Temp.	
					DB °F	WB °F
900	35°F	0.27	60,095	38,414	37.5	37.1
	40°F		51,172	33,783	42.3	41.9
	45°F		41,679	29,267	46.9	46.4
	50°F		31,660	24,791	51.5	51.0
1200	35°F	0.45	73,410	47,401	40.5	40.1
	40°F		62,231	41,851	44.7	44.3
	45°F		50,433	36,470	48.9	48.4
	50°F		38,123	31,114	53.0	52.5
1500	35°F	0.64	84,406	55,164	43	42.6
	40°F		71,293	48,909	46.8	46.3
	45°F		57,543	42,602	50.7	50.2
	50°F		43,329	36,791	54.3	53.8

4 Ton - 4 Row DX Coil						
85°F EDB / 71°F EWB						
CFM	Suction Temp.	APD FV	Total Capacity	Sensible Capacity	Leaving Air Temp.	
					DB °F	WB °F
1200	35°F	0.27	93,401	53,090	44.1	43.7
	40°F		81,721	47,685	48.2	47.7
	45°F		69,520	42,310	52.4	51.9
	50°F		57,087	37,382	56.2	55.6
1600	35°F	0.46	110,774	64,124	47.9	47.4
	40°F		96,347	57,654	51.7	51.2
	45°F		81,432	51,644	55.1	54.5
	50°F		66,461	45,940	58.4	57.8
2000	35°F	0.67	124,593	73,502	51.0	50.5
	40°F		107,863	66,660	54.2	53.7
	45°F		90,708	59,986	57.3	56.7
	50°F		73,687	53,706	60.2	59.6

4 Ton - 4 Row DX Coil						
80°F EDB / 67°F EWB						
CFM	Suction Temp.	APD FV	Total Capacity	Sensible Capacity	Leaving Air Temp.	
					DB °F	WB °F
1200	35°F	0.27	79,366	48,249	42.8	42.4
	40°F		68,040	42,870	47.0	46.5
	45°F		56,234	37,527	51.1	50.6
	50°F		44,182	32,651	54.8	54.3
1600	35°F	0.46	94,129	58,483	46.2	45.7
	40°F		80,217	52,285	49.8	49.3
	45°F		65,869	46,061	53.4	52.9
	50°F		51,437	40,397	56.6	56.0
2000	35°F	0.67	105,871	67,505	48.8	48.3
	40°F		89,804	60,343	52.1	51.6
	45°F		73,372	53,735	55.1	54.6
	50°F		57,029	47,477	58.0	57.4

4 Ton - 4 Row DX Coil						
77°F EDB / 64°F EWB						
CFM	Suction Temp.	APD FV	Total Capacity	Sensible Capacity	Leaving Air Temp.	
					DB °F	WB °F
1200	35°F	0.27	69,615	45,491	41.9	41.5
	40°F		58,534	40,135	46.1	45.6
	45°F		47,002	34,806	50.2	49.7
	50°F		35,215	29,970	53.9	53.4
1600	35°F	0.46	82,564	55,394	45.0	44.6
	40°F		69,010	49,188	48.6	48.1
	45°F		55,056	42,996	52.1	51.6
	50°F		40,998	37,368	55.4	54.8
2000	35°F	0.67	92,864	64,160	47.3	46.8
	40°F		77,258	56,976	50.6	50.1
	45°F		61,327	50,425	53.7	53.2
	50°F		44,529	34,287	56.4	55.8



(R-410A) Cooling Capacity VX*D-060, 090, 120

5 Ton - 4 Row DX Coil						
85°F EDB / 71°F EWB						
CFM	Suction Temp.	APD FV	Total Capacity	Sensible Capacity	Leaving Air Temp.	
					DB °F	WB °F
1500	35°F	0.26	117,696	68,837	43.8	43.4
	40°F		103,024	60,010	48.0	47.5
	45°F		87,685	53,225	52.2	51.7
	50°F		72,037	47,005	56.0	55.4
2000	35°F	0.43	139,818	80,788	47.6	47.1
	40°F		121,665	72,605	51.4	50.9
	45°F		102,881	65,011	54.9	54.4
	50°F		84,006	57,797	58.3	57.7
2500	35°F	0.62	157,459	92,637	50.7	50.2
	40°F		136,377	83,983	53.9	53.4
	45°F		114,743	75,537	57.1	56.5
	50°F		93,255	67,583	60.0	59.4

5 Ton - 4 Row DX Coil						
80°F EDB / 67°F EWB						
CFM	Suction Temp.	APD FV	Total Capacity	Sensible Capacity	Leaving Air Temp.	
					DB °F	WB °F
1500	35°F	0.26	100,011	60,725	42.6	42.2
	40°F		85,776	53,934	46.7	46.2
	45°F		70,927	47,189	50.9	50.4
	50°F		55,752	41,035	54.7	54.2
2000	35°F	0.43	118,809	73,663	45.9	45.4
	40°F		101,295	65,820	49.6	49.1
	45°F		83,219	57,957	53.2	52.7
	50°F		65,016	50,797	56.5	55.9
2500	35°F	0.62	133,798	85,060	48.5	48.0
	40°F		113,545	75,996	51.9	51.4
	45°F		92,814	67,636	55.0	54.5
	50°F		72,174	59,714	57.9	57.3

5 Ton - 4 Row DX Coil						
77°F EDB / 64°F EWB						
CFM	Suction Temp.	APD FV	Total Capacity	Sensible Capacity	Leaving Air Temp.	
					DB °F	WB °F
1500	35°F	0.26	87,723	57,235	41.7	41.3
	40°F		73,792	50,475	45.9	45.4
	45°F		59,204	43,747	50.0	49.5
	50°F		44,437	37,645	53.8	53.3
2000	35°F	0.43	104,211	69,747	44.7	44.3
	40°F		87,143	61,899	48.4	47.9
	45°F		69,557	54,073	52.0	51.5
	50°F		51,821	46,959	55.3	54.7
2500	35°F	0.62	117,359	80,818	47.1	46.6
	40°F		97,681	71,723	50.5	50.0
	45°F		77,578	63,437	53.5	53.0
	50°F		56,144	43,230	56.4	55.8

7.5 Ton - 4 Row DX Coil						
85°F EDB / 71°F EWB						
CFM	Suction Temp.	APD FV	Total Capacity	Sensible Capacity	Leaving Air Temp.	
					DB °F	WB °F
2500	35°F	0.29	176,813	100,497	47.8	47.3
	40°F		154,580	90,388	51.6	51.1
	45°F		131,400	80,959	55.0	54.5
	50°F		107,833	71,890	58.4	57.8
3000	35°F	0.40	195,550	112,530	50.3	49.8
	40°F		170,392	101,521	53.7	53.2
	45°F		144,314	91,203	56.9	56.3
	50°F		118,024	81,341	59.9	59.3
3500	35°F	0.53	211,632	122,923	52.5	52.0
	40°F		183,884	111,681	55.5	54.9
	45°F		155,262	100,626	58.4	57.8
	50°F		126,613	90,111	61.2	60.6

7.5 Ton - 4 Row DX Coil						
80°F EDB / 67°F EWB						
CFM	Suction Temp.	APD FV	Total Capacity	Sensible Capacity	Leaving Air Temp.	
					DB °F	WB °F
2500	35°F	0.29	150,244	91,581	46.1	45.6
	40°F		128,700	81,864	49.7	49.2
	45°F		106,287	72,056	53.3	52.8
	50°F		83,456	63,027	56.7	56.1
3000	35°F	0.40	166,166	102,735	48.3	47.8
	40°F		141,865	91,690	51.7	50.8
	45°F		116,733	81,447	54.9	54.4
	50°F		91,343	71,602	57.9	57.3
3500	35°F	0.53	179,831	112,943	50.2	49.7
	40°F		153,098	101,114	53.3	52.8
	45°F		125,589	90,116	56.2	55.6
	50°F		97,990	79,591	59.0	58.4

7.5 Ton - 4 Row DX Coil						
77°F EDB / 64°F EWB						
CFM	Suction Temp.	APD FV	Total Capacity	Sensible Capacity	Leaving Air Temp.	
					DB °F	WB °F
2500	35°F	0.29	131,785	86,605	45.0	44.6
	40°F		110,719	76,859	48.6	48.1
	45°F		88,840	67,064	52.2	51.7
	50°F		66,519	58,073	55.5	54.9
3000	35°F	0.40	145,750	97,407	47.0	46.5
	40°F		122,045	86,828	50.2	49.7
	45°F		97,570	76,100	53.5	53.0
	50°F		72,805	66,279	56.6	56.0
3500	35°F	0.53	157,736	107,307	48.6	48.1
	40°F		131,708	95,424	51.8	51.3
	45°F		104,972	84,482	54.7	54.2
	50°F		72,734	66,005	57.8	57.2

10 Ton - 4 Row DX Coil						
85°F EDB / 71°F EWB						
CFM	Suction Temp.	APD FV	Total Capacity	Sensible Capacity	Leaving Air Temp.	
					DB °F	WB °F
3000	35°F	0.24	22,599	126,330	46.0	45.4
	40°F		195,935	113,885	49.9	49.3
	45°F		166,978	101,329	53.8	53.3
	50°F		137,360	87,731	57.3	57.0
4000	35°F	0.40	263,782	151,350	50.0	49.1
	40°F		229,679	136,498	53.4	52.5
	45°F		194,614	122,576	56.7	56.0
	50°F		159,228	109,260	59.7	59.1
5000	35°F	0.60	295,235	172,320	53.1	52.6
	40°F		256,307	156,671	56.0	55.4
	45°F		216,213	141,299	58.9	58.3
	50°F		176,166	126,697	61.6	60.6

10 Ton - 4 Row DX Coil						
80°F EDB / 67°F EWB						
CFM	Suction Temp.	APD FV	Total Capacity	Sensible Capacity	Leaving Air Temp.	
					DB °F	WB °F
3000	35°F	0.24	190,000	114,950	44.6	43.9
	40°F		163,132	102,482	48.4	47.8
	45°F		135,066	89,974	52.3	51.8
	50°F		106,308	78,448	55.8	55.5
4000	35°F	0.40	223,890	138,148	48.1	47.4
	40°F		191,226	123,235	51.5	50.6
	45°F		157,420	109,419	54.7	54.1
	50°F		123,232	96,130	57.8	57.1
5000	35°F	0.60	250,871	158,426	50.7	49.8
	40°F		213,396	141,952	53.7	52.8
	45°F		174,891	126,645	56.6	55.6
	50°F		136,341	112,019	59.3	58.3

10 Ton - 4 Row DX Coil						
77°F EDB / 64°F EWB						
CFM	Suction Temp.	APD FV	Total Capacity	Sensible Capacity	Leaving Air Temp.	
					DB °F	WB °F
3000	35°F	0.24	166,656	108,498	43.5	42.9
	40°F		140,340	96,027	47.4	46.8
	45°F		112,894	83,521	51.2	50.6
	50°F		84,733	72,054	54.8	54.5
4000	35°F	0.40	196,382	130,942	46.7	45.8
	40°F		164,510	116,654	50.0	49.4
	45°F		131,578	102,186	53.4	52.7
	50°F		98,223	88,933	56.4	55.8
5000	35°F	0.60	220,048	150,608	49.1	48.2
	40°F		183,582	134,083	52.2	50.9
	45°F		146,181	118,850	55.0	54.1
	50°F		101,824	78,404	58.2	56.8



(R-22) Cooling Capacity VX*D-024, 036, 048

2 Ton - 4 Row DX Coil						
85°F EDB / 71°F EWB						
CFM	Suction Temp.	APD FV	Total Capacity	Sensible Capacity	Leaving Air Temp.	
					DB °F	WB °F
600	35°F	0.18	42520	23280	47.6	46.0
	40°F		37560	20660	51.4	49.5
	45°F		32070	18500	56.2	53.2
	50°F		25140	16210	58.9	56.8
800	35°F	0.27	51010	28060	51.1	49.0
	40°F		45720	25650	54.1	51.7
	45°F		38880	22810	57.5	55.0
	50°F		31270	19960	60.9	58.4
1000	35°F	0.4	57850	32130	54.0	51.4
	40°F		51620	29410	56.6	53.9
	45°F		44540	26580	59.3	56.5
	50°F		35560	23299	62.5	59.6

2 Ton - 4 Row DX Coil						
80°F EDB / 67°F EWB						
CFM	Suction Temp.	APD FV	Total Capacity	Sensible Capacity	Leaving Air Temp.	
					DB °F	WB °F
600	35°F	0.18	36111	21220	46.2	44.5
	40°F		31100	18700	50.2	48.2
	45°F		25650	18310	54.0	51.9
	50°F		20990	14460	57.0	54.8
800	35°F	0.27	44010	25990	48.9	46.8
	40°F		37710	22970	52.5	50.1
	45°F		30910	20080	56.0	53.5
	50°F		23460	17230	59.4	56.9
1000	35°F	0.4	49640	29630	51.7	49.1
	40°F		43250	26710	54.5	51.7
	45°F		35320	23420	57.6	54.7
	50°F		26700	20170	60.7	57.8

2 Ton - 4 Row DX Coil						
77°F EDB / 64°F EWB						
CFM	Suction Temp.	APD FV	Total Capacity	Sensible Capacity	Leaving Air Temp.	
					DB °F	WB °F
600	35°F	0.18	31240	19830	45.6	43.8
	40°F		27720	18020	49.4	48.4
	45°F		22170	15470	52.5	50.2
	50°F		16890	13340	55.9	53.8
800	35°F	0.27	37370	24000	48.5	46.1
	40°F		32060	21430	51.5	49.0
	45°F		28780	19110	54.3	51.6
	50°F		19490	16210	57.7	56.1
1000	35°F	0.4	41910	27360	51.0	56.1
	40°F		35590	24490	53.7	50.7
	45°F		30650	22350	55.7	52.7
	50°F		22230	19050	56.9	55.8

3 Ton - 4 Row DX Coil						
85°F EDB / 71°F EWB						
CFM	Suction Temp.	APD FV	Total Capacity	Sensible Capacity	Leaving Air Temp.	
					DB °F	WB °F
900	35°F	0.27	57720	30190	52.0	49.8
	40°F		49550	26040	54.9	52.5
	45°F		43790	25680	57.5	56.0
	50°F		36770	23020	60.3	57.8
1200	35°F	0.45	66990	37380	54.9	52.2
	40°F		58620	34180	57.5	54.6
	45°F		52800	31520	50.7	56.7
	50°F		42260	27660	52.8	59.7
1500	35°F	0.64	75900	43860	58.5	55.2
	40°F		69080	40700	60.5	57.0
	45°F		59470	37060	62.6	59.1
	50°F		49190	33539	64.8	61.2

3 Ton - 4 Row DX Coil						
80°F EDB / 67°F EWB						
CFM	Suction Temp.	APD FV	Total Capacity	Sensible Capacity	Leaving Air Temp.	
					DB °F	WB °F
900	35°F	0.27	48740	28950	49.2	47.1
	40°F		42980	26100	52.3	49.9
	45°F		35370	22830	55.7	53.2
	50°F		27050	19620	59.2	56.6
1200	35°F	0.45	47170	34330	52.6	49.9
	40°F		50180	31190	55.1	52.2
	45°F		41930	27790	57.9	54.8
	50°F		31910	24020	60.9	57.8
1500	35°F	0.64	64990	39230	55.0	51.8
	40°F		55860	35550	57.3	54.0
	45°F		47450	32210	59.5	56.0
	50°F		36930	27930	62.2	58.7

3 Ton - 4 Row DX Coil						
77°F EDB / 64°F EWB						
CFM	Suction Temp.	APD FV	Total Capacity	Sensible Capacity	Leaving Air Temp.	
					DB °F	WB °F
900	35°F	0.27	43650	27840	47.8	45.4
	40°F		36620	24360	51.3	46.7
	45°F		29000	21030	54.8	52.1
	50°F		22400	18420	57.5	54.9
1200	35°F	0.45	50650	32910	50.9	49.1
	40°F		43520	29550	53.5	50.5
	45°F		34350	25690	56.9	53.5
	50°F		24110	21760	59.8	56.6
1500	35°F	0.64	56400	37360	53.3	50.0
	40°F		46360	33760	55.6	52.1
	45°F		36830	29840	56.1	54.5
	50°F		27130	25410	60.9	57.3

4 Ton - 4 Row DX Coil						
85°F EDB / 71°F EWB						
CFM	Suction Temp.	APD FV	Total Capacity	Sensible Capacity	Leaving Air Temp.	
					DB °F	WB °F
1200	35°F	0.27	84340	46360	47.7	46.2
	40°F		74510	41810	51.4	49.7
	45°F		70870	37390	54.9	53.3
	50°F		50220	32270	59.0	57.5
1600	35°F	0.46	102310	56810	50.7	48.9
	40°F		90250	51560	53.9	52.0
	45°F		78230	46770	56.8	54.9
	50°F		61490	40960	60.5	56.6
2000	35°F	0.67	118830	66680	52.8	50.8
	40°F		106210	60960	55.6	53.5
	45°F		87980	54320	58.8	56.7
	50°F		70990	48299	61.7	59.6

4 Ton - 4 Row DX Coil						
80°F EDB / 67°F EWB						
CFM	Suction Temp.	APD FV	Total Capacity	Sensible Capacity	Leaving Air Temp.	
					DB °F	WB °F
1200	35°F	0.27	71750	42380	46.2	44.7
	40°F		62300	37540	49.5	46.1
	45°F		49730	32490	64.1	52.4
	50°F		36130	27930	58.2	56.6
1600	35°F	0.46	87000	52010	48.9	47.1
	40°F		74650	46420	52.3	50.3
	45°F		60980	40820	55.6	53.7
	50°F		44220	34580	59.3	57.5
2000	35°F	0.67	101650	61390	50.8	48.6
	40°F		85880	54490	53.9	51.6
	45°F		70680	48390	58.9	54.7
	50°F		51520	41410	60.2	56.1

4 Ton - 4 Row DX Coil						
77°F EDB / 64°F EWB						
CFM	Suction Temp.	APD FV	Total Capacity	Sensible Capacity	Leaving Air Temp.	
					DB °F	WB °F
1200	35°F	0.27	62680	40050	45.3	43.7
	40°F		52250	34950	49.3	47.5
	45°F		39960	29660	53.5	51.7
	50°F		28660	25299	57.0	55.2
1600	35°F	0.46	77140	49860	47.5	45.5
	40°F		64200	43780	51.0	46.9
	45°F		48350	37150	54.9	52.9
	50°F		36610	32310	57.6	55.6
2000	35°F	0.67	87540	57690	49.6	47.4
	40°F		72710	51030	52.7	50.5
	45°F		66130	44270	56.0	53.7
	50°F		41830	36900	56.5	56.3



(R-22) Cooling Capacity VX*D-060, 090, 120

5 Ton - 4 Row DX Coil						
85°F EDB / 71°F EWB						
CFM	Suction Temp.	APD FV	Total Capacity	Sensible Capacity	Leaving Air Temp.	
					DB °F	WB °F
1500	35°F	0.26	103400	56970	48.3	45.8
	40°F		92060	51810	51.7	50.0
	45°F		79140	46480	55.1	53.4
	50°F		65000	41160	56.5	56.9
2000	35°F	0.43	126620	70550	51.0	49.7
	40°F		111660	64010	54.1	52.2
	45°F		95530	58020	57.0	55.1
	50°F		75000	50220	60.8	59.0
2500	35°F	0.62	148040	83170	52.9	50.9
	40°F		130710	75930	55.7	56.3
	45°F		108690	67490	58.9	56.9
	50°F		87020	59840	61.9	59.9

5 Ton - 4 Row DX Coil						
80°F EDB / 67°F EWB						
CFM	Suction Temp.	APD FV	Total Capacity	Sensible Capacity	Leaving Air Temp.	
					DB °F	WB °F
1500	35°F	0.26	89640	52960	46.2	44.7
	40°F		77990	47250	49.9	48.2
	45°F		66240	42290	53.0	51.3
	50°F		49940	35930	57.1	56.4
2000	35°F	0.43	107740	64560	49.1	47.3
	40°F		93970	58340	52.1	50.2
	45°F		78280	51870	55.2	53.3
	50°F		61170	45390	58.3	56.4
2500	35°F	0.62	124600	75650	51.1	49.0
	40°F		109450	69040	53.6	51.5
	45°F		89570	61070	56.6	54.5
	50°F		95810	53630	59.5	57.4

5 Ton - 4 Row DX Coil						
77°F EDB / 64°F EWB						
CFM	Suction Temp.	APD FV	Total Capacity	Sensible Capacity	Leaving Air Temp.	
					DB °F	WB °F
1500	35°F	0.26	78960	50360	45.1	43.5
	40°F		66830	44410	46.8	47.1
	45°F		53980	38760	52.4	50.6
	50°F		36680	31960	56.7	55.0
2000	35°F	0.43	94840	61570	47.7	45.8
	40°F		82420	56730	50.5	48.5
	45°F		66230	48610	53.8	51.8
	50°F		47730	41620	57.2	55.2
2500	35°F	0.62	110250	72550	49.4	47.3
	40°F		94280	65440	52.1	49.9
	45°F		74020	56920	55.4	53.1
	50°F		53660	49190	56.3	56.1

7.5 Ton - 4 Row DX Coil						
85°F EDB / 71°F EWB						
CFM	Suction Temp.	APD FV	Total Capacity	Sensible Capacity	Leaving Air Temp.	
					DB °F	WB °F
2500	35°F	0.29	190740	104420	44.7	43.5
	40°F		172780	95710	48.1	46.7
	45°F		149670	85600	52.0	50.8
	50°F		89100	63150	60.6	59.6
3000	35°F	0.4	217510	119610	46.5	45.2
	40°F		192920	108250	50.2	48.8
	45°F		120210	98740	53.2	51.9
	50°F		144080	88670	56.5	55.2
3500	35°F	0.53	286670	131250	48.8	47.4
	40°F		216480	122300	51.3	49.8
	45°F		186920	110180	54.6	53.2
	50°F		161130	100480	57.3	55.9

7.5 Ton - 4 Row DX Coil						
80°F EDB / 67°F EWB						
CFM	Suction Temp.	APD FV	Total Capacity	Sensible Capacity	Leaving Air Temp.	
					DB °F	WB °F
2500	35°F	0.29	161450	95000	43.7	42.5
	40°F		140260	84530	47.7	48.3
	45°F		120960	75980	50.9	49.6
	50°F		75160	58280	57.7	56.6
3000	35°F	0.4	177570	105630	46.3	45.0
	40°F		161080	97880	48.8	47.4
	45°F		135710	85950	52.3	50.9
	50°F		87050	68460	58.2	57.0
3500	35°F	0.53	208240	123560	46.2	44.8
	40°F		180600	110700	49.8	48.2
	45°F		125300	86100	55.9	54.5
	50°F		88250	74750	59.5	58.3

7.5 Ton - 4 Row DX Coil						
77°F EDB / 64°F EWB						
CFM	Suction Temp.	APD FV	Total Capacity	Sensible Capacity	Leaving Air Temp.	
					DB °F	WB °F
2500	35°F	0.29	146550	92700	41.7	40.7
	40°F		127640	82730	45.5	44.2
	45°F		76250	60370	54.2	52.6
	50°F		75190	59940	54.0	52.9
3000	35°F	0.4	161130	103110	44.3	43.0
	40°F		137460	91500	48.0	46.5
	45°F		115530	81810	51.1	49.6
	50°F		87850	70650	54.6	53.2
3500	35°F	0.53	173500	112710	46.4	44.9
	40°F		154890	103630	48.8	47.2
	45°F		126700	91680	52.1	50.5
	50°F		98520	80470	55.1	53.7

10 Ton - 4 Row DX Coil						
85°F EDB / 71°F EWB						
CFM	Suction Temp.	APD FV	Total Capacity	Sensible Capacity	Leaving Air Temp.	
					DB °F	WB °F
3000	35°F	0.24	237190	104720	43.8	42.9
	40°F		212010	92410	47.7	45.8
	45°F		187750	81780	51.1	50.0
	50°F		160800	71000	54.5	53.5
4000	35°F	0.4	296180	129170	46.2	45.2
	40°F		262900	114390	49.8	48.7
	45°F		232090	101440	52.3	51.8
	50°F		154830	72940	59.7	58.9
5000	35°F	0.6	307900	134050	51.5	50.4
	40°F		223550	10330	56.3	52.9
	45°F		264600	116590	54.8	53.8
	50°F		223550	101330	57.7	56.8

10 Ton - 4 Row DX Coil						
80°F EDB / 67°F EWB						
CFM	Suction Temp.	APD FV	Total Capacity	Sensible Capacity	Leaving Air Temp.	
					DB °F	WB °F
3000	35°F	0.24	205640	120540	41.8	40.5
	40°F		183660	109020	45.3	44.0
	45°F		151160	93910	50.1	48.8
	50°F		115960	79650	54.6	53.5
4000	35°F	0.4	253370	149270	44.3	43.1
	40°F		221450	133610	46.1	46.7
	45°F		151070	104190	55.1	53.8
	50°F		105660	87700	59.0	57.9
5000	35°F	0.6	292360	173900	46.7	45.3
	40°F		253210	155750	50.2	48.7
	45°F		179010	125670	58.0	54.5
	50°F		126580	108800	59.8	58.3

10 Ton - 4 Row DX Coil						
77°F EDB / 64°F EWB						
CFM	Suction Temp.	APD FV	Total Capacity	Sensible Capacity	Leaving Air Temp.	
					DB °F	WB °F
3000	35°F	0.24	182440	115090	40.5	39.8
	40°F		156530	101080	45.0	43.7
	45°F		93280	73330	53.5	52.0
	50°F		95640	74250	53.8	52.2
4000	35°F	0.4	204590	132290	46.8	44.2
	40°F		182680	121760	48.1	46.6
	45°F		151700	108180	51.3	49.8
	50°F		119920	96340	54.3	53.0
5000	35°F	0.6	247410	160690	45.4	44.9
	40°F		219490	147480	49.0	47.4
	45°F		151860	119080	54.4	52.8
	50°F		138400	113870	56.3	53.8