

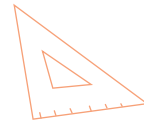

EDUCATION



$$3+1$$



INTERACTIVE FLAT PANELS DISPLAYS

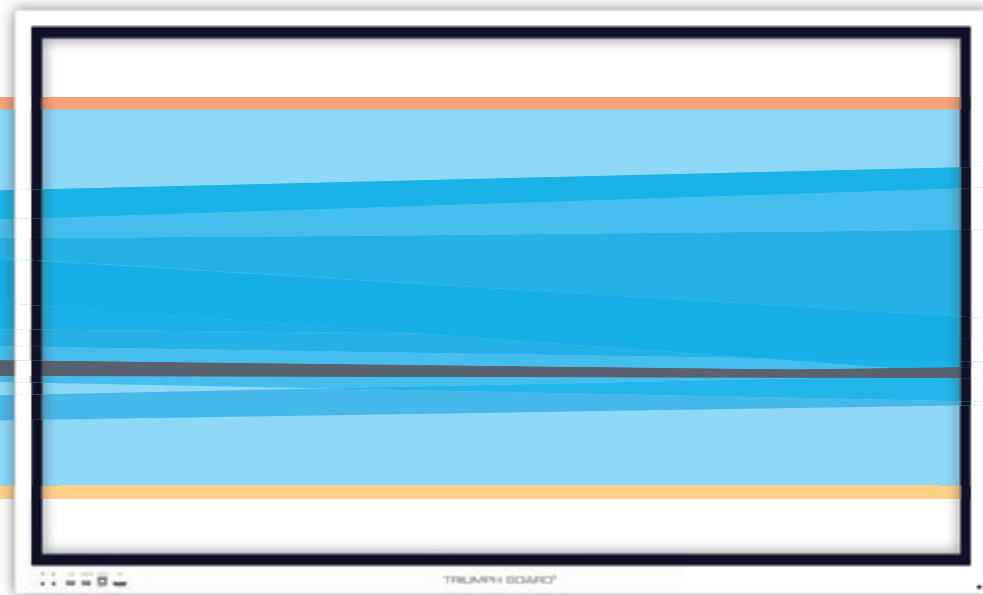

TRIUMPH BOARD®
One Idea Ahead



Abc

$$\sqrt{33}$$





TRIUMPH BOARD is a manufacturer of interactive presentation solutions and audio-visual equipment, selling to the Educational and Business sectors worldwide.

The TRIUMPH BOARD product offering includes interactive flat panels, interactive whiteboards, interactive projectors, videoconferencing systems, document cameras, and other related products, and a wide range of supporting software.

TRIUMPH BOARD can deliver unbeatable interactive solutions, with best-in-class software on best-in-class hardware, thanks to its global partnerships with leading technology suppliers and the most advanced factories in the world.

The strategy of combining ISO certified intelligent design and efficient manufacturing in Asia and Europe enables TRIUMPH BOARD to deliver unbeatable solutions with high "European" quality at affordable prices.

No message is complete without a powerful presentation. TRIUMPH BOARD has built its business on being "One Idea Ahead" in interactive solutions that meet the evolving needs of users and enable the presenter to perform at the next level! TRIUMPH BOARD products are created to enhance presentation effectiveness in an educational or corporate environment.

TRIUMPH BOARD has established country partners that enable us to promote, educate and install our product line in local markets with country language support.

About us

We are proud of our successes and look forward to surpassing your expectations in the future!



ABC

Interactive Flat Panels

We have developed a fully integrated, professional solution – TRIUMPH BOARD Interactive Flat Panels are an effective presentation tool for training or giving presentations interactively in any type of classroom. The latest IR LED optical technology with 32 touch inputs provides the ideal multi-touch experience. The optional built-in OPS PC with incorporated Intel® Core™ Processors and Microsoft Windows 10 Pro (OEM) with a selection of language options and pre-installed applications, delivers top-of-the-line performance. A wide range of accessories such as LiftBoxes or mobile stands makes the solution a zero-compromise!

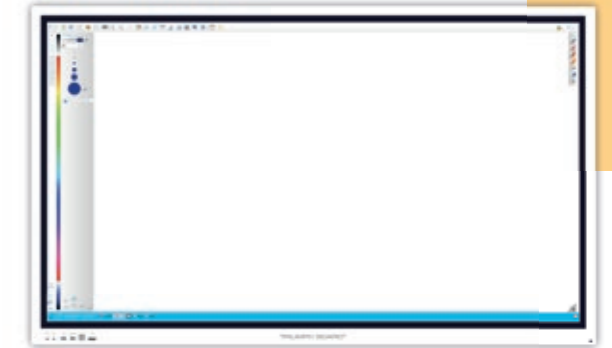

Interactive Whiteboards

TRIUMPH BOARD offers uniquely cost-effective interactive whiteboard solutions. With the TRIUMPH BOARD interactive whiteboard you will be able to learn and teach in any classroom setting. TRIUMPH BOARD 10-touch input with IR cell LED Optical technology enables simultaneous collaboration between students using the wide range of included applications.



Interactive Presentation Products

TRIUMPH BOARD provides a range of audio-visual presentation products to suit all types of applications from interactive ultra short throw and short throw projectors, document cameras, to videoconferencing systems.



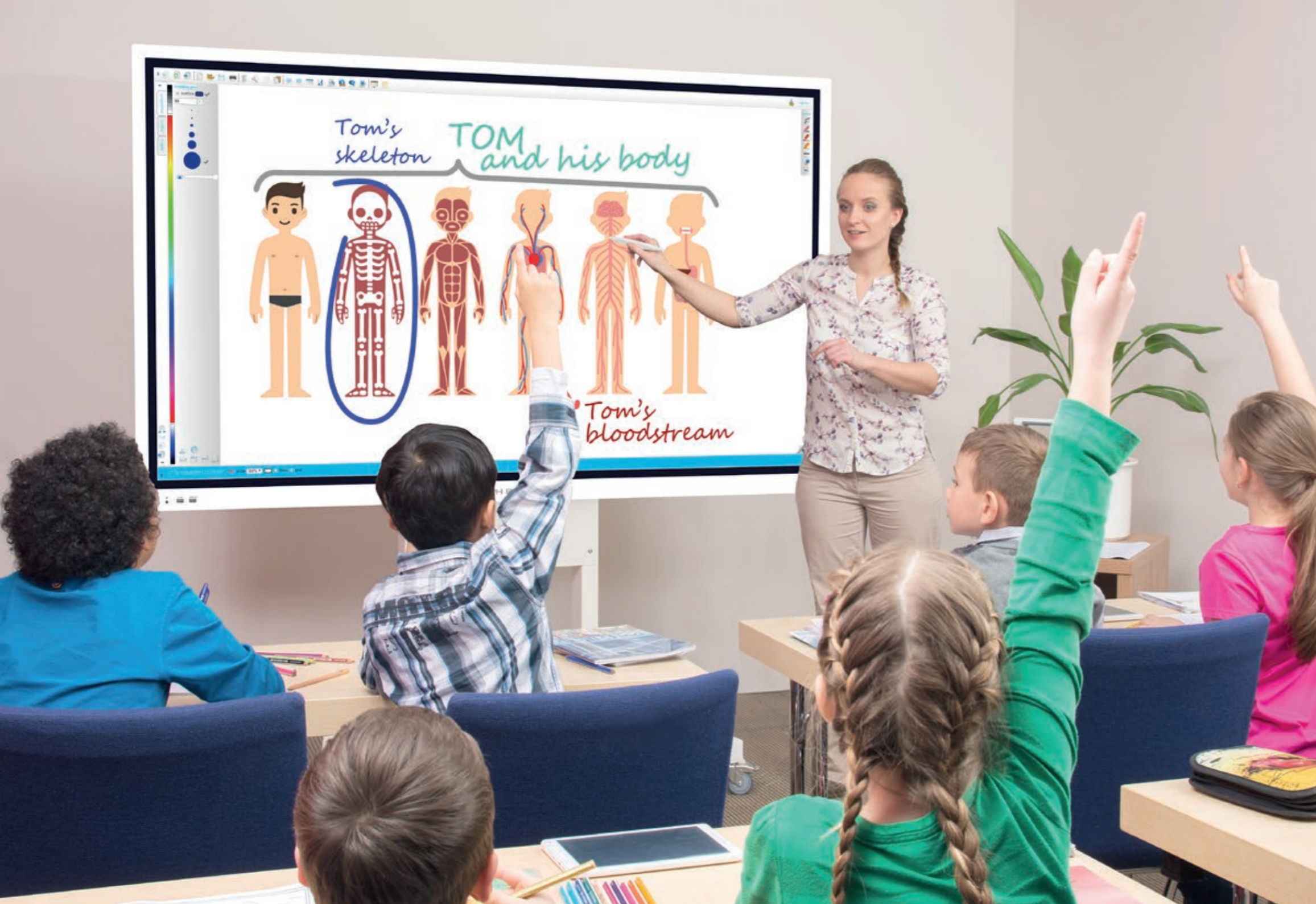

55" 65" 75" 86" 98"
INTERACTIVE FLAT PANELS

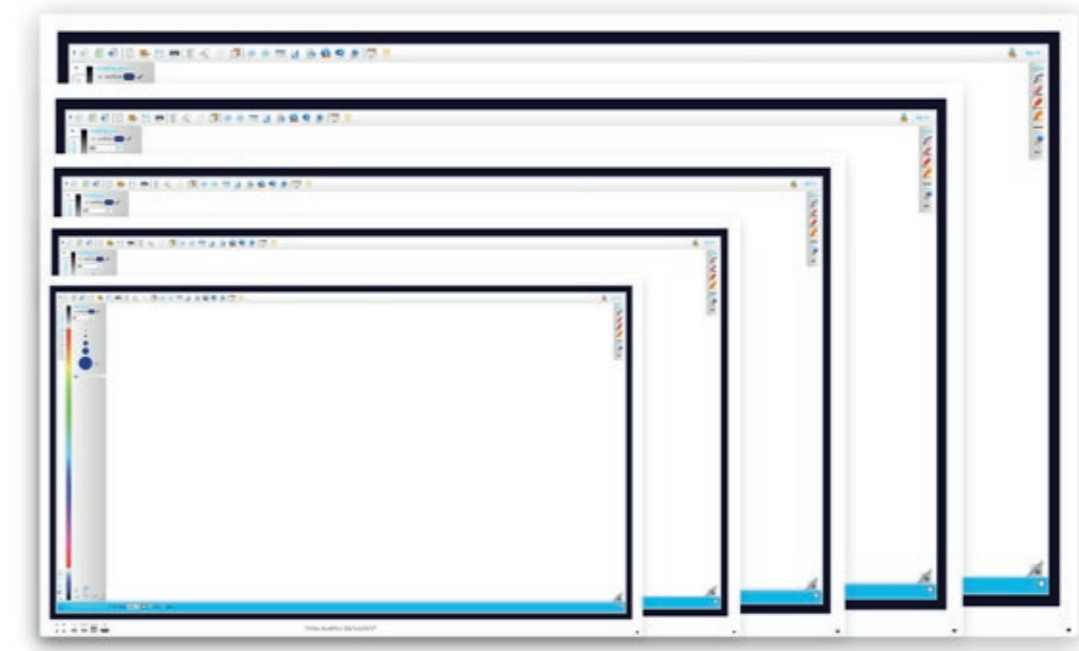

- Multi-Touch (32 touch - inputs)
- UHD resolution
- Android System
- OPS PC built in (optional)
- TRIUMPH CLOUD
online annotation software & cloud data storage
- DisplayNote
collaboration software (cloud)
- EShare
wireless content sharing software



TRIUMPH BOARD INTERACTIVE FLAT PANELS are fully integrated, professional, multi-touch UHD displays with amazing performance and stunning visuals. TRIUMPH BOARD INTERACTIVE FLAT PANELS are effective presentation tool for showing lessons or presentations interactively in any classroom.

No need for a projector! Easy installation!
 No limitations due to light conditions!
 Elegant and stylish appearance.



OPS PC (optional) for INTERACTIVE FLAT PANELS

TRIUMPH BOARD OPS PCs for IFP are powerful, fully integrated personal computers for TRIUMPH BOARD Interactive Flat Panels with the Android system.

TRIUMPH BOARD OPS PCs for IFP are equipped with 6th generation Intel® Core™ Processors (Skylake), Intel Integrated Graphics and 8 GB RAM DDR4, which gives high power for running applications. The up to 256 GB SSD disk provides high speed and sufficient capacity for saving and storing the user's data.

TRIUMPH BOARD OPS PCs for IFP includes a license of Microsoft Windows 10 Pro (OEM) with selection of language options and preinstalled applications.

Features

- Fully compatible with TRIUMPH BOARD INTERACTIVE FLAT PANELS
- Fully integrated solution in a slim design
- High-speed due to the powerful Intel® Core™ processor and SSD disk
- Ideal product with sufficient power for pre-installed SW bundle and collaboration



wide range of connectivity

$\sqrt{33}$

OPS PC

| | |
|-------------------|-------------------------------------------------------------|
| EAN: | 8592580113758 |
| Processor: | i3 - Intel® Core™ i3-6100TE Skylake 4M Cache 2.7GHz |
| Graphics: | Intel Integrated Graphics |
| Sound Card: | Integrated High Definition Audio Stereo |
| Networking: | Integrated 10 / 100 / 1000 M Adaption |
| Memory: | 8GB DDR4 2133Mhz |
| Hard Drive: | 128 GB SSD Disk |
| WIFI: | IEEE 802.11 ac (2.4G/5G), Bluetooth 4.0 |
| USB: | 1x USB 2.0 and 2x USB 3.0 |
| Audio: | Side Headphone and Mic Ports |
| Lan Port (RJ45): | 1 |
| VGA Out: | 1 |
| HDMI Out: | 1 (up to 4K2K resolution) |
| Operation System: | Microsoft Windows 10 Professional (OEM) 64-bit MultiLang |

OPS PC PRO

| | |
|-------------------|-------------------------------------------------------------|
| EAN: | 8592580113307 |
| Processor: | i7 - Intel® Core™ i7- 6700 TE Skylake 4M Cache 2.4GHz |
| Graphics: | Intel Integrated Graphics |
| Sound Card: | Integrated High Definition Audio Stereo |
| Networking: | Integrated 10 / 100 / 1000 M Adaption |
| Memory: | 8GB DDR4 2133Mhz |
| Hard Drive: | 256 GB SSD Disk |
| WIFI: | IEEE 802.11 ac (2.4G/5G), Bluetooth 4.0 |
| USB: | 1x USB 2.0 and 2x USB 3.0 |
| Audio: | Side Headphone and Mic Ports |
| Lan Port (RJ45): | 1 |
| VGA Out: | 1 |
| HDMI Out: | 1 (up to 4K2K resolution) |
| Operation System: | Microsoft Windows 10 Professional (OEM) 64-bit MultiLang |

3+1

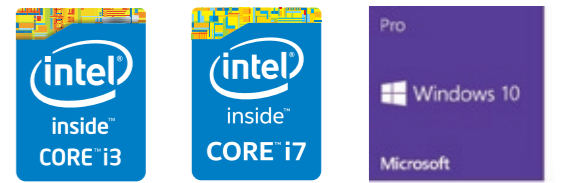

Accessories



Features

- Hard-wearing components
- Simple assembly, quiet operations and easy handling
- No need for maintenance
- Elegant modern design



Specifications

| | |
|----------------------------------------|-----------------------------------------------------------------------------------------------------------------|
| EAN: | 8592580082825 |
| Stand material: | steel |
| Assembly: | VESA 400x200, 600x400, 600x200, 300x300, 400x400, 600x600 |
| Lift of Stand: | 675 mm / 26.6" |
| Centre of LED LCD at highest position: | 1735 mm / 68.3" |
| Centre of LED LCD at lowest position: | 1060 mm / 41.7" |
| Maximum Load: | 130 kg / 286.6 lb |
| Control unit: | Panel with connectors, switch, IEC C22, cable intake |
| Power source: | 110 / 230 VAC |
| Dimensions: | 1385 x 688 x 710 mm / 54.5" x 27.1" x 28" |
| Net weight: | 49 kg / 108 lb |
| Gross weight: | 52 kg / 115 lb |
| Accessories (optional): | Pen Tray for Mobile Stand with Electric Lift for IFP Laptop Tray for Mobile Stand with Electric Lift for IFP |

Mobile Stand with Electric Lift

for IFPs

The TRIUMPH BOARD Mobile Stand for TRIUMPH BOARD Interactive Flat Panel has an Electric Lift to change the height over a range of 67,5cm / 26.6".

A b c



The TRIUMPH BOARD Mobile Stand with Electric Lift provides comfort and convenience, with easy attachment of the IFP, and quiet and smooth operation, enabling perfect positioning in any situation.

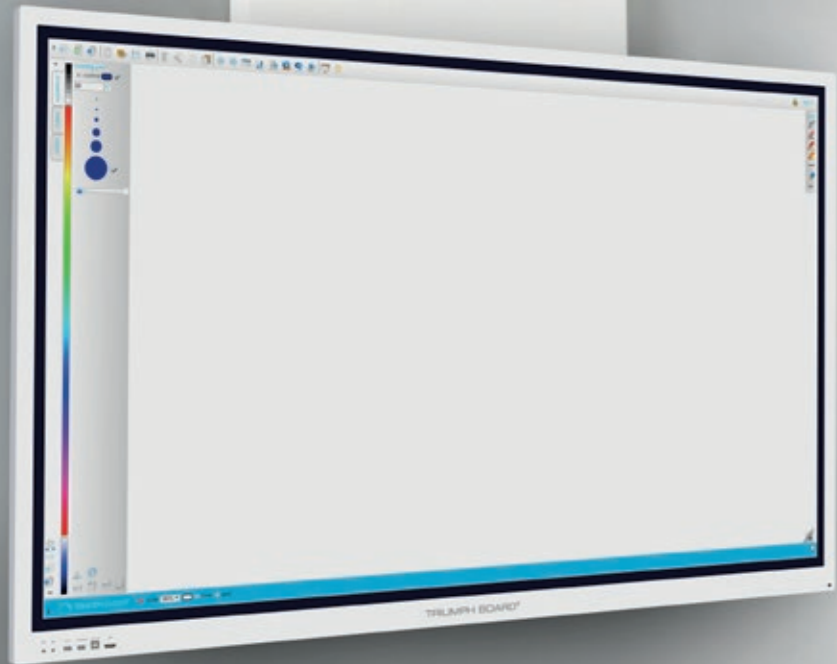

Stands

LiftBox for IFPs



The TRIUMPH BOARD LiftBox for IFP is the perfect and easy solution to move the IFP up and down, without electric power.

The partially overlapping weight range gives the installer the choice between a travel of 40 and 65 cm / 16 and 25 inches. All LiftBox models offer a wide range of accessories and come in a compact and stylish white design that is hidden behind the screen.

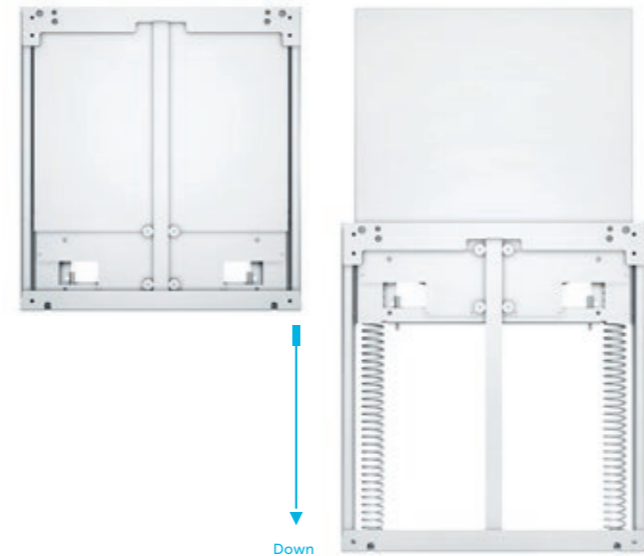

Mobile Stand for LiftBox

The TRIUMPH BOARD Mobile Stand for LiftBox has an assembly hitch for easily adding of IFP.

The Stand also comes with wheels for easy movement, which can be easily blocked to prevent any unwanted movement of the Stand.

The TRIUMPH BOARD Mobile Stand for the LiftBox is designed to provide a high level of convenience as well as smooth attachment of IFP throughout its lifespan.

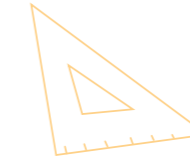

Tilt Frame for LiftBox for 55" IFP



Tilt Frame for the TRIUMPH BOARD LiftBox for 55" IFP allows you to tilt out the 55" IFP by 60 degrees.

Tilt Frame is a perfect and easy solution that helps you to interface with the screen as well as collaborate with colleagues together on one screen.

Tilt Frame is an optional accessory to the TRIUMPH BOARD LiftBox for 55" IFP.



Features

- Ergonomic and easy to use
- Quality product, safe to use
- Compact design - product disappears behind the screen
- Long product lifetime
- Fast and easy installation; maintenance-free
- Low transport and installation cost

ABC

Software

TRIUMPH CLOUD

Online Annotation



TRIUMPH CLOUD is unique online annotation software that runs on all interactive flat panels, interactive whiteboards, interactive projectors, tablets and other systems using the latest web technologies. TRIUMPH CLOUD can always be used anywhere and with any hardware and operating system (Windows, MAC OS, iOS, Android, Linux, Chrome OS).

- Online with automatic free updates and no installation
- Hardware & Platform Independent
- LAN & Wi-Fi Collaboration (Windows/iOS/Android/Linux/Chrome OS)
- Multi-touch & Pen (10 inputs)
- Cloud data storage - **myfiles**
- Import SMART Notebook files & Promethean iwb files
- MyScript Handwriting Recognition (TEXT, SHAPE, MATH)
- G Suite for Education integration (user importing and sharing to Google Classroom)
- MS Office 365 integration (with Azure Active Directory Premium and Office 365 account)
- 25 Languages

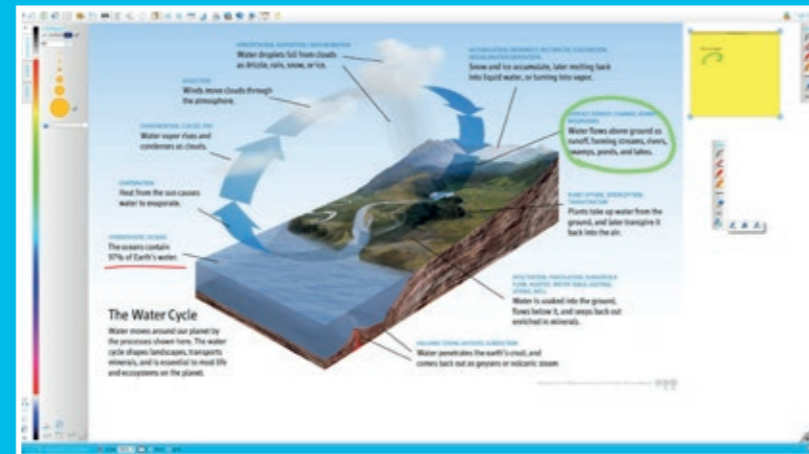
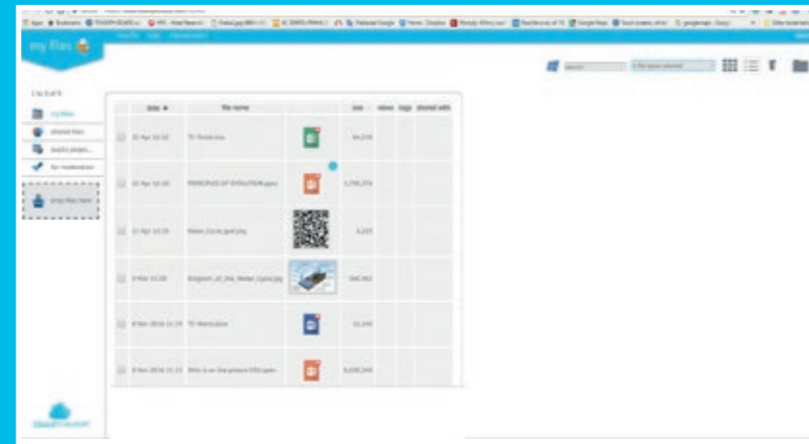
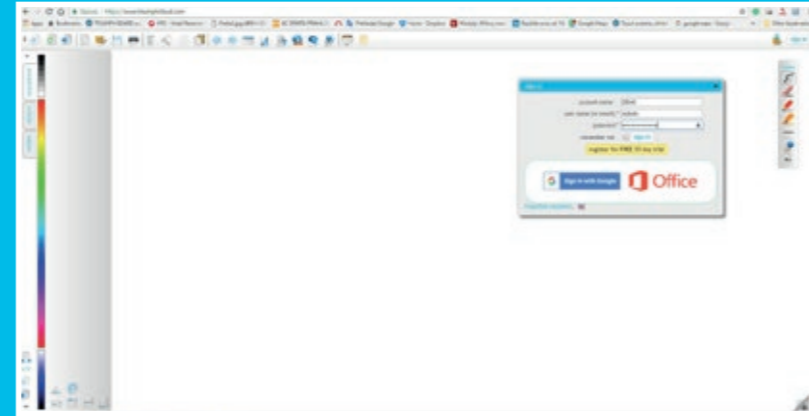

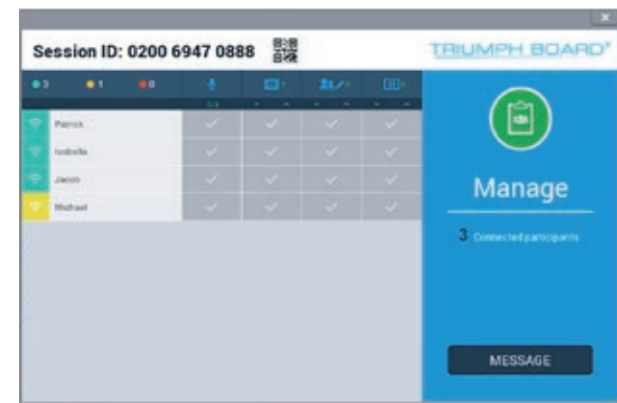
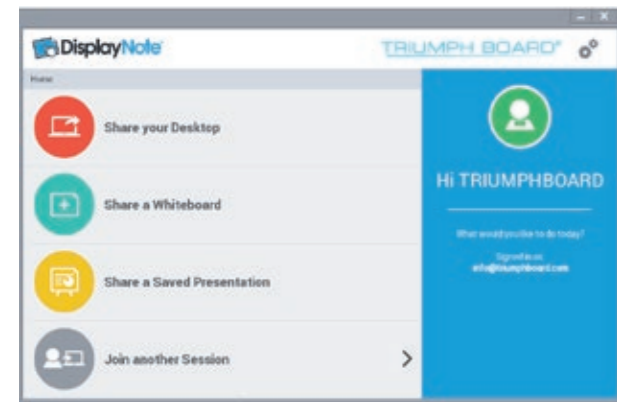
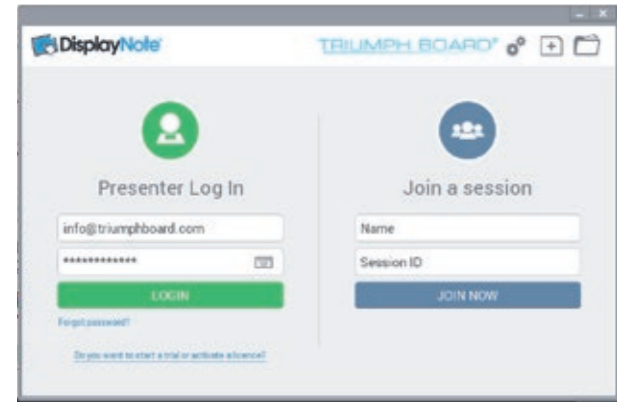

Software

DisplayNote Collaboration

With DisplayNote you can capture the teacher's notes, slides, images and video in real-time on your own device. You can add your own notes and work together in real-time collaboration.

- Add written notes, post-its and references to any slide, image and video
- Share annotations with the teacher and other connected student devices
- Send private messages - the teacher can send and receive private messages to one or more participants
- DisplayNote lets teacher and students connect like never before and on the platform / device that suits them
- Works on almost any device and across all the major platforms (Windows, Android, iOS and Mac OS)

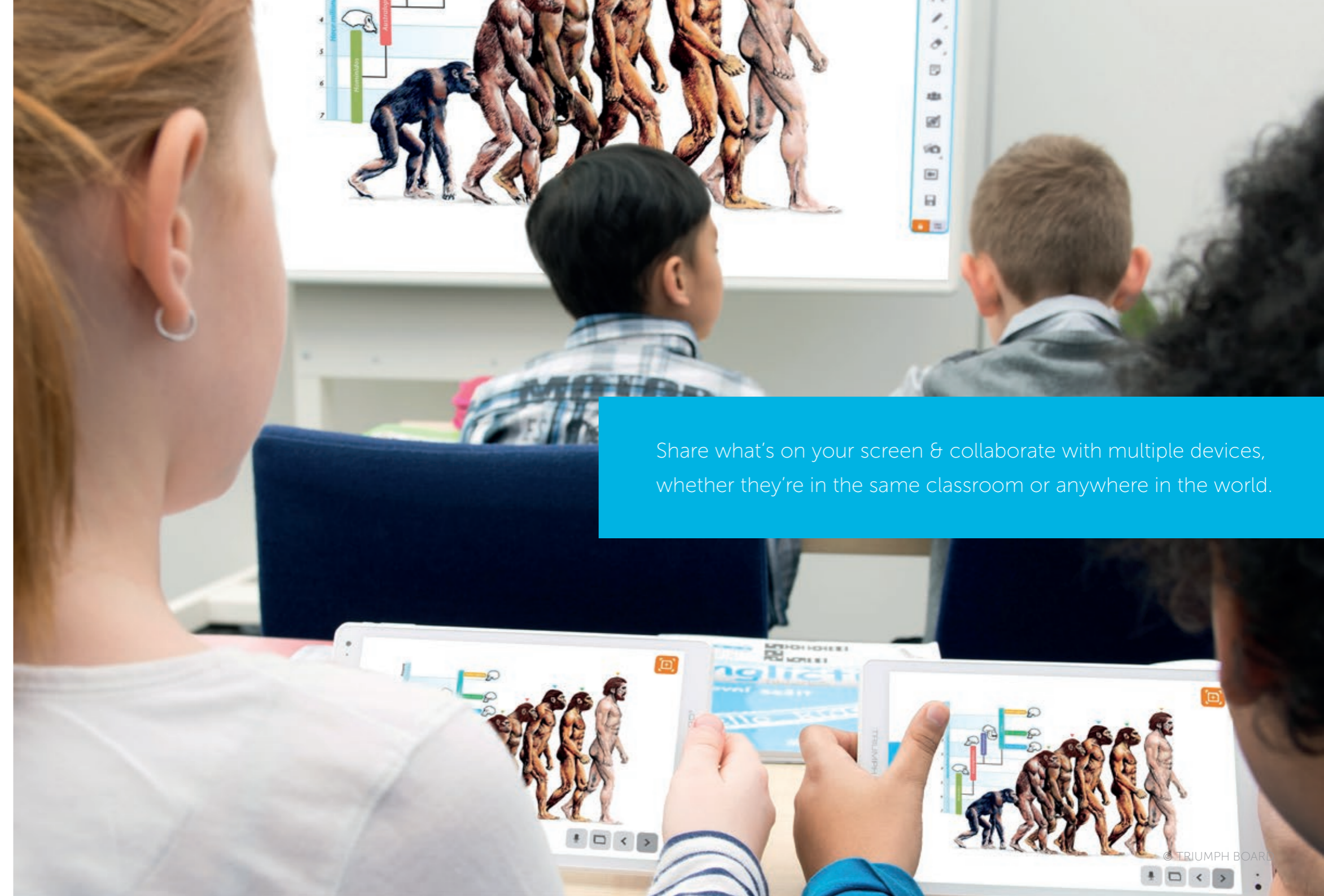

Share what's on your screen & collaborate with multiple devices, whether they're in the same classroom or anywhere in the world.



Software

EShare

Content sharing

The EShare application enables you to transform the way you share content. You can browse and share files, videos and photos quickly and easily. You can collaborate or mirror your screen flawlessly in real time.

- Wirelessly stream any media file and document from your device
- Stream music, photos, and video wirelessly
- Mirror the screen of your device
- EShare lets you stream any file from your smartphone
- EShare Server is available for Windows, Android and Mac OS*
- Eshare Client works on almost any device and across all the major platforms (Windows, Android, iOS and Mac OS)

*Available with TRIUMPH BOARD IFP UHD models.

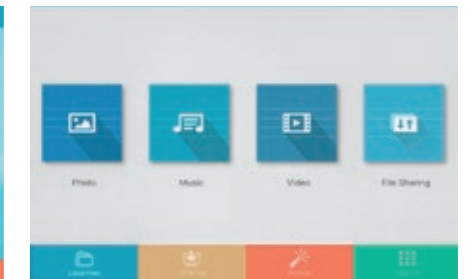
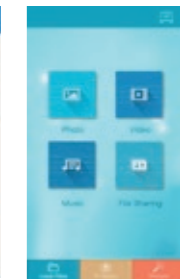
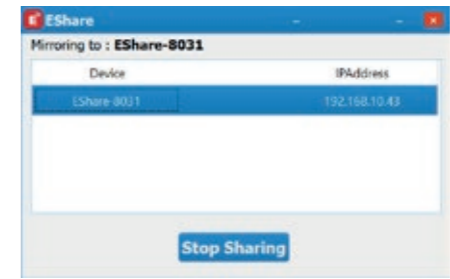

Specifications

| | IFP 55" | IFP 65" | IFP 75" |
|----------------------------|--------------------------------------------------------------------------------------------------------------------------------------------------------------------------------------------------|--------------------------------------------------------------------------------------------------------------------------------------------------------------------------------------------------|--------------------------------------------------------------------------------------------------------------------------------------------------------------------------------------------------|
| EAN: | 8592580113215 | 8592580113222 | 8592580112638 |
| Display | | | |
| Screen Type: | Open Cell DLED Backlight | Open Cell DLED Backlight | Open Cell DLED Backlight |
| Aspect Ratio: | 16:9 | 16:9 | 16:9 |
| Resolution: | UHD (3840 x 2160) | UHD (3840 x 2160) | UHD (3840 x 2160) |
| Display Area: | 1238,7 x 709,5 mm 48.8" x 27.9" (HxV) | 1444,1 x 819,8 mm 56.9" x 32.3" (HxV) | 1649,66 x 927,94 mm 65" x 36.5" (HxV) |
| Display Colors: | 1.07 B (10 - bit) | 1.07 B (10 - bit) | 1.07 B (10 - bit) |
| Diagonal size: | 55" | 65" | 75" |
| Brightness: | 350 cd/m2 | 450 cd/m2 | 450 cd/m2 |
| Contrast: | 1200 : 1 | 1200 : 1 | 1200 : 1 |
| Response Time: | 6 ms | 6 ms | 6 ms |
| Refreshing Frequency: | 60 Hz | 60 Hz | 60 Hz |
| View Angle: | 178°/178° (H/V) | 178°/178° (H/V) | 178°/178° (H/V) |
| Life Time: | 50,000 hrs | 50,000 hrs | 50,000 hrs |
| Mount System: | VESA 400 x 400 (Optional) | VESA 400 x 400 (Optional) | VESA 600 x 400 (Optional) |
| Outline Dimension: | 1299 x 673 x 122 mm 51.1" x 26.5" x 4.8" | 1510,5 x 886,5 x 122 mm 59.4" x 34.9" x 4.8" | 1736,8 x 1035,3x 108 mm 68.4" x 40.7" x 4.3" |
| Package Dimension: | 1520 x 1165 x 320 mm 59.8" x 45.9" x 12.6" | 1765 x 1165 x 320 mm 69.5" x 45.9" x 12.6" | 1990 x 1165 x 320 mm 78.3" x 45.9" x 12.6" |
| Net/Gross weight: | 39,6 / 54,7 kg 87,3 / 120,6 lb | 49,9 / 68,5 kg 109,9 / 151 lb | 61,2 / 87,7 kg 134,8 / 193,3 lb |
| Touch System | | | |
| Touch Input: | 32 Touch Input | 32 Touch Input | 32 Touch Input |
| Sensing Type: | Infrared Transmission (multi-touch) | Infrared Transmission (multi-touch) | Infrared Transmission (multi-touch) |
| Response Time: | < 15 ms (typ) | < 15 ms (typ) | < 15 ms (typ) |
| Output Coordinates: | 32768 x 32768 | 32768 x 32768 | 32768 x 32768 |
| Communication Mode: | HDMI 2.0 and Full-speed USB | HDMI 2.0 and Full-speed USB | HDMI 2.0 and Full-speed USB |
| Writing Screen: | Mohs hardness of 7 | Mohs hardness of 7 | Mohs hardness of 7 |
| Compatibility: | Windows, Mac, Linux, Android, Chrome | Windows, Mac, Linux, Android, Chrome | Windows, Mac, Linux, Android, Chrome |
| PC System: | OPS PC (Optional) | OPS PC (Optional) | OPS PC (Optional) |
| Ambient Conditions | | | |
| Operation Temperature: | 0°- 40°C | 0°- 40°C | 0°- 40°C |
| Operation Humidity: | 20 - 80% RH | 20 - 80% RH | 20 - 80% RH |
| Storage Temperature: | -10°- 60°C | -10°- 60°C | -10°- 60°C |
| Storage Humidity: | 10 - 60% RH | 10 - 60% RH | 10 - 60% RH |
| Sound System: | | | |
| Power Amplify: | 2 x 20 W | 2 x 20 W | 2 x 20 W |
| Number of Sound Box: | 2 | 2 | 2 |
| Sound: | Surround | Surround | Surround |
| Power | | | |
| Power Requirements: | 100~240 V AC 50/60 Hz | 100~240 V AC 50/60 Hz | 100~240 V AC 50/60 Hz |
| Overall Power Consumption: | < 207 W | < 320 W | < 320 W |
| Standby Power Consumption: | < 0.5 W | < 0.5 W | < 0.5 W |
| Android Built-In | | | |
| Version: | 5.0 | 5.0 | 5.0 |
| CPU: | ARM Cortex A53 | ARM Cortex A53 | ARM Cortex A53 |
| GPU: | Mali-450MP4 | Mali-450 | Mali-450 |
| RAM/ROM: | 2GB DDR3/16GB | 2GB DDR3/16GB | 2GB DDR3/16GB |
| Inputs and Outputs | HDMI-IN 5x, HDMI-OUT 1x, VGA 1x, PC AUDIO 1x, Y PB PR 1x, LAN 1x, AV 1x, AV OUT 1x, EARPHONE 1x, SPDIF 1x, USB 2.0 2x, USB 3.0 2x, PC USB 2x, TOUCH USB 5x, AUDIO 1x, MIC 1x, RS232 IN/OUT 1x/1x | HDMI-IN 5x, HDMI-OUT 1x, VGA 1x, PC AUDIO 1x, Y PB PR 1x, LAN 1x, AV 1x, AV OUT 1x, EARPHONE 1x, SPDIF 1x, USB 2.0 2x, USB 3.0 2x, PC USB 2x, TOUCH USB 5x, AUDIO 1x, MIC 1x, RS232 IN/OUT 1x/1x | HDMI-IN 4x, HDMI-OUT 1x, VGA 1x, PC AUDIO 1x, Y PB PR 1x, LAN 1x, AV 1x, AV OUT 1x, EARPHONE 1x, SPDIF 1x, USB 2.0 2x, USB 3.0 2x, PC USB 2x, TOUCH USB 5x, AUDIO 1x, MIC 1x, RS232 IN/OUT 1x/1x |
| Accessories | 1x HDMI Cable, 1x AC Power Cable, 1x VGA Cable, 1x USB Cable, 1x Audio Cable, 2x Stylus, 1x Remote Control, 1x Wall Mount Bracket, Quick Start Guide, Manual | | |

| | IFP 86" | IFP 98" |
|----------------------------|--------------------------------------------------------------------------------------------------------------------------------------------------------------------------------------------------|--------------------------------------------------------------------------------------------------------------------------------------------------------------------------------------------------|
| EAN: | 8592580112645 | 8592580113727 |
| Display | | |
| Screen Type: | Open Cell DLED Backlight | Open Cell DLED Backlight |
| Aspect Ratio: | 16:9 | 16:9 |
| Resolution: | UHD (3840 x 2160) | UHD (3840 x 2160) |
| Display Area: | 1895,04 x 1065,96 mm 74.6" x 42" (HxV) | 2158,84 x 1214,35 mm 85" x 47.8" (HxV) |
| Display Colors: | 1.07 B (10 - bit) | 1.06 GB (10 - bit) |
| Diagonal size: | 86" | 98" |
| Brightness: | 400 cd/m2 | 400 cd/m2 |
| Contrast: | 1200 : 1 | 1300 : 1 |
| Response Time: | 6 ms | 5 ms |
| Refreshing Frequency: | 60 Hz | 60 Hz |
| View Angle: | 178°/178° (H/V) | 178°/178° (H/V) |
| Life Time: | 50,000 hrs | 50,000 hrs |
| Mount System: | 700 x 400 (Optional) | VESA 800 x 400 (Optional) |
| Outline Dimension: | 1990 x 1181 x 114,5 mm 78.3" x 46.5" x 4.5" | 2254 x 1321 x 114,5 mm 88.7" x 52" x 4.5" |
| Package Dimension: | 2200 x 1490 x 360 mm 86.6" x 58.6" x 14.2" | 2525 x 1870 x 435 mm 99.4" x 73.6" x 17.1" |
| Net/Gross weight: | 93,3 / 121 kg 205,6 / 266,8 lb | 165 / 220 kg 364 / 485 lb |
| Touch System | | |
| Touch Input: | 32 Touch Input | 32 Touch Input |
| Sensing Type: | Infrared Transmission (multi-touch) | Infrared Transmission (multi-touch) |
| Response Time: | < 11 ms (typ) | < 8 ms (typ) |
| Output Coordinates: | 32768 x 32768 | 32768 x 32768 |
| Communication Mode: | HDMI 2.0 and Full-speed USB | HDMI 2.0 and Full-speed USB |
| Writing Screen: | Mohs hardness of 7 | Mohs hardness of 7 |
| Compatibility: | Windows, Mac, Linux, Android, Chrome | Windows, Mac, Linux, Android, Chrome |
| PC System: | OPS PC (Optional) | OPS PC (Optional) |
| Ambient Conditions | | |
| Operation Temperature: | 0°- 40°C | 0°- 40°C |
| Operation Humidity: | 20 - 80% RH | 20 - 80% RH |
| Storage Temperature: | -10°- 60°C | -10°- 60°C |
| Storage Humidity: | 10 - 60% RH | 10 - 60% RH |
| Sound System: | | |
| Power Amplify: | 2 x 20 W | 2 x 20 W |
| Number of Sound Box: | 2 | 2 |
| Sound: | Surround | Surround |
| Power | | |
| Power Requirements: | 100~240 V AC 50/60 Hz | 100~240 V AC 50/60 Hz |
| Overall Power Consumption: | < 500 W | < 540 W |
| Standby Power Consumption: | < 0.5 W | < 0.5 W |
| Android Built-In | | |
| Version: | 5.0 | 5.0 |
| CPU: | ARM Cortex A53 | ARM Cortex A53 |
| GPU: | Mali-450 | Mali-450 |
| RAM/ROM: | 2GB DDR3/16GB | 2GB DDR3/16 GB |
| Inputs and Outputs | HDMI-IN 5x, HDMI-OUT 1x, VGA 1x, PC AUDIO 1x, Y PB PR 1x, LAN 1x, AV 1x, AV OUT 1x, EARPHONE 1x, SPDIF 1x, USB 2.0 2x, USB 3.0 2x, PC USB 2x, TOUCH USB 5x, AUDIO 1x, MIC 1x, RS232 IN/OUT 1x/1x | HDMI-IN 5x, HDMI-OUT 1x, VGA 1x, PC AUDIO 1x, Y PB PR 1x, LAN 1x, AV 1x, AV OUT 1x, EARPHONE 1x, SPDIF 1x, USB 2.0 1x, USB 3.0 1x, PC USB 2x, TOUCH USB 5x, AUDIO 1x, MIC 1x, RS232 IN/OUT 1x/1x |
| Accessories | 1x HDMI Cable, 1x AC Power Cable, 1x VGA Cable, 1x USB Cable, 1x Audio Cable, 2x Stylus, 1x Remote Control, 1x Wall Mount Bracket, Quick Start Guide, Manual (for IFP 86" 1x VESA Interface) | |

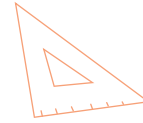

3+1

Contact:

info@triumphboard.com

www.triumphboard.com

www.youtube.com/triumphboard

$\sqrt{33}$



Abc