

**TEL-TRU**  
ROCHESTER, NY, USA

# RAY™ PRESSURE SNUBBERS



Tel-Tru Manufacturing Co.

# A Simple, Cost-Effective Solution to Damaging Pressure Surges And Shocks

Through its unique design, the RAY SNUBBER'S™ rugged piston moving within its chamber kicks out the sediment and pipe scale that clog needle valves, filters, porous metal discs and other designs.

There is a RAY SNUBBER™ for every application:

- Brass, Stainless Steel, Aluminum or Monel construction
- Pressure ratings from vacuum to 20,000 psi (up to 60,000 psi with special high pressure connections)
- Air, Water, Gases, Petrochemicals
- British taper threads or American NPT
- 104 models in stock featuring 12 piston options

To accommodate variations in viscosities, every snubber is delivered with three different-sized easily changed pistons. And because the piston is the only moving part, maintenance is minimal. No parts to be regularly cleaned or replaced.

## C E N T E R J O I N T S N U B B E R

Preferred for Non-Repetitive Installation  
Center Joint Allows Easy Piston Changing.

### MODEL 010

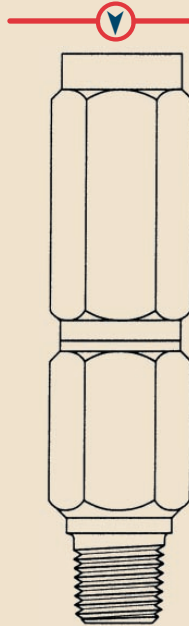

MODEL NO.	CONNECTIONS INLET	CONNECTIONS OUTLET	BODY MTRL	MAX. PSI	LN.	HEX
010B			Brass	3000	3.46	.750
010S	1/4 NPT	1/4 NPT	303 Stainless	5000		
010SS			316 Stainless	5000		

Available in British Taper Pipe Threads: Add BPS to part number.

### MODEL 050

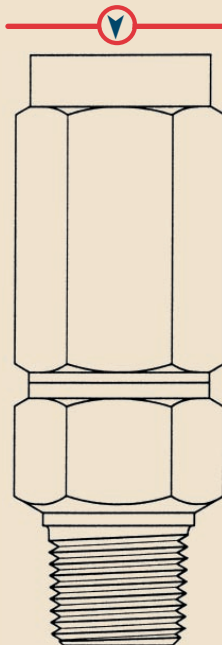

MODEL NO.	CONNECTIONS INLET	CONNECTIONS OUTLET	BODY MTRL	MAX. PSI	LN.	HEX
050B	3/8 NPT	3/8 NPT	Brass	5000	3.61	1.125

Available in British Taper Pipe Threads: Add BPS to part number.

### MODEL 060

MODEL NO.	CONNECTIONS INLET	CONNECTIONS OUTLET	BODY MTRL	MAX. PSI	LN.	HEX
060B			Brass	5000	3.61	1.125
060S	1/2 NPT	1/2 NPT	303 Stainless	10,000		
060SS			316 Stainless	10,000		

Available in British Taper Pipe Threads: Add BPS to part number.

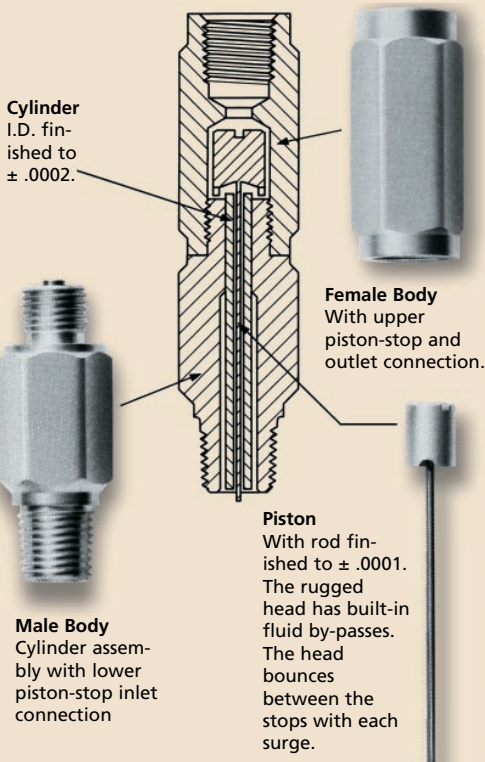

(Shown Approximately 3/4 Size)

Product drawings shown at approximately 3/4 size

Ideal for OEM market. While pistons can be changed, product quality and uniformity make it unnecessary.

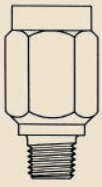

**MODEL 047**

MODEL NO.	CONNECTIONS		BODY MTRL	MAX. PSI	LN.	HEX
	INLET	OUTLET				
047B	1/8 NPT	1/8 NPT	Brass	3000	1.5	.688
047S			303 Stainless	5000		
047SS			316 Stainless	5000		

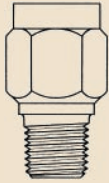

**MODEL 022**

MODEL NO.	CONNECTIONS		BODY MTRL	MAX. PSI	LN.	HEX
	INLET	OUTLET				
022B	1/4 NPT	1/4 NPT	Brass	5000	1.5	.75
022M			Monel (Nickel-Copper)	5,000		
022S			303 Stainless	15,000		
022SS			316 Stainless	15,000		

Available in British Taper Pipe Threads: Add BPS to part number.

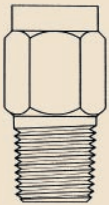

**MODEL 104**

MODEL NO.	CONNECTIONS		BODY MTRL	MAX. PSI	LN.	HEX
	INLET	OUTLET				
104S	3/8 NPT	1/4 NPT	303 Stainless	10,000	1.69	.75

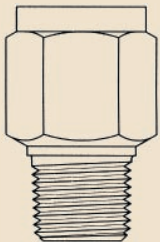

**MODEL 023**

MODEL NO.	CONNECTIONS		BODY MTRL	MAX. PSI	LN.	HEX
	INLET	OUTLET				
023B	1/2 NPT	1/2 NPT	Brass	5000	2	1.125
023M			Nickel-Copper (Monel)	5,000		
023S			303 Stainless	15,000		
023SS			316 Stainless	15,000		

Available in British Taper Pipe Threads: Add BPS to part number.

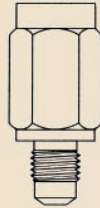

**MODEL 095**

MODEL NO.	CONNECTIONS		BODY MTRL	MAX. PSI	LN.	HEX
	INLET	OUTLET				
095B	1/4 Tube	1/8 NPT	Brass	3000	1.75	.688

Tube angle is 37° with 7/16-20 threads.

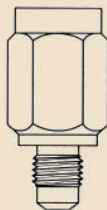

**MODEL 078**

MODEL NO.	CONNECTIONS		BODY MTRL	MAX. PSI	LN.	HEX
	INLET	OUTLET				
078B	1/4 Tube	1/4 NPT	Brass	3000	1.75	.75
078S			303 Stainless	5000		

Tube angle is 37° with 7/16-20 threads.

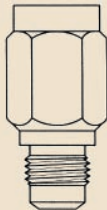

**MODEL 108**

MODEL NO.	CONNECTIONS		BODY MTRL	MAX. PSI	LN.	HEX
	INLET	OUTLET				
108B	3/8 Tube	1/4 NPT	Brass	3000	1.75	.75

Tube angle is 37° with 9/16-18 threads.

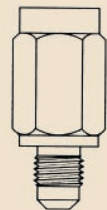

**MODEL 125**

MODEL NO.	CONNECTIONS		BODY MTRL	MAX. PSI	LN.	HEX
	INLET	OUTLET				
125B	1/4 Tube	1/8 NPT	Brass	3000	1.75	.688

Tube angle is 45° with 7/16-20 threads.

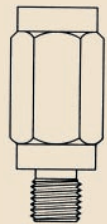

**MODEL 055**

MODEL NO.	CONNECTIONS		BODY MTRL	MAX. PSI	LN.	HEX
	INLET	OUTLET				
055M	1/4 Tube	O-Ring Seal	Monel	6000	1.85	.688
055SS		O-Ring Seal	316 Stainless	6000		

Inlet is to MS33514-4 & SAE J514, commonly called flareless bite type. Outlet is to MS16142. Both threads are 7/16-20. Nuts, ferrules &/or O-Rings must be ordered separately.

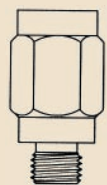

**MODEL 039**

MODEL NO.	CONNECTIONS		BODY MTRL	MAX. PSI	LN.	HEX
	INLET	OUTLET				
039B	1/4 Tube	O-Ring Seal	Brass	3000	1.5	.688
039M		O-Ring Seal	Monel	6000		
039SS		O-Ring Seal	316 Stainless	6000		

Outlet is to MS16142. Both threads are 7/16-20. O-Rings are available.

To accommodate variations in viscosities, every snubber is delivered with three different-sized easily changed pistons.

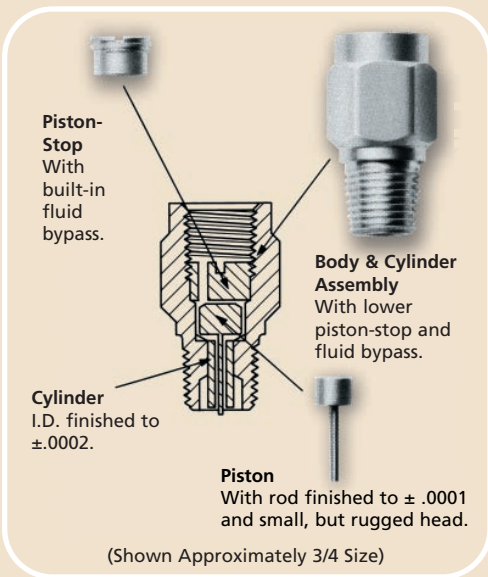



# RAY™ POROUS METAL PRESSURE SNUBBERS

**A Simple, Cost-Effective Solution to Protecting Valuable Control Instruments...**

- Stop shocks and pulsations that damage pressure instruments
- Cut cost of maintenance, calibration, and repair
- Assure accuracy of instruments and readings
- Prevent false operation of control equipment
- Increase life of instruments

**AVAILABLE IN THE FOLLOWING POROSITIES AND END CONNECTIONS:**

Body Type	Material	Maximum PSI	Light Oil & Water "E" Porosity	Air, Steam & Gas "G" Porosity
1/4" NPT Length: 1.5" Weight: 2 oz.	Brass	5,000	722BE	722BG
	303 Stainless	15,000	722SE	722SG
1/2" NPT Length: 2.2" Weight: 8 oz.	Brass	5,000	723BE	723BG
	303 Stainless	15,000	723SE	723SG



**OTHER PRODUCTS AVAILABLE FROM TEL-TRU**



**BIMETAL THERMOMETERS**

**THERMOWELLS**  
**DIAPHRAGM SEALS**  
**GAS ACTUATED THERMOMETERS**  
**VAPOR TENSION THERMOMETERS**  
**GLASS INDUSTRIAL THERMOMETERS**  
**SURFACE THERMOMETERS**  
**DIGITAL THERMOMETERS**  
**NON-CONTACT THERMOMETERS**



**PRESSURE GAUGES**



**Tel-Tru Manufacturing Company**

408 St. Paul St., Rochester NY 14605

Phone: 585.232.1440 • 800.232.5335 • Fax: 585.232.3857 • E-mail: [info@teltru.com](mailto:info@teltru.com) • Web: <http://www.teltru.com>