

# PD650

Large Display Process Meter



PROCESS

- 4-20 mA, 1-5 V, 0-5 V, 0-10 V inputs
- 4½ digits + extra zero display for rate
- 6-digit display for total
- Programmable exponent for weirs & flumes
- Pump alternation control
- Two 24 VDC transmitter power supplies
- 2 or 4 relays & 4-20 mA output options
- 115 VAC or 230 VAC power
- Operating temperature: -20 to 65°C
- Die-cast aluminum, NEMA 4X, IP66/IP67

# PD650 Large Display Process Meter

## GENERAL FEATURES

The PD650 is a Large Display Process Meter with flow rate, totalizer, and batch control capabilities. This meter accepts the common process signals such as 4-20 mA, 0-5 VDC, 1-5 VDC and 0-10 VDC and displays these signals in engineering units on a large, high efficiency, 4½ digit red LED display. This meter also provides two isolated 24 V power supplies to drive both the input and output loops. Options include up to 4 relays for alarms or batch controlling, as well as an isolated 4-20 mA transmitter output.

## Key Features

- Two 24 VDC isolated transmitter power supplies
- 115 or 230 VAC field selectable power
- Rate display in units per day, second, minute or hour
- Programmable setpoints for latching/non-latching relay operation
- Built-in snubbers on each relay contact
- Any setpoint programmable for process/rate or total
- Programmable exponent for weirs and flumes
- Pump Alternation

## Single Button Scaling

Single button scaling means this meter can be completely programmed using only one button. Simply press the **ENTER** button to initiate the automatic menu scan. When the desired menu appears press the **ENTER** button again. Once in a menu, press the **ENTER** button when the display reads the desired value. To exit setup & programming press the **ACK** (Acknowledge) button while displaying any of the main menus. It's that simple!

## Stand Alone Scaling (Internal or External)

This meter may be scaled without a signal source or calibrated with a signal source.

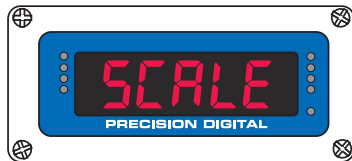

## Lockout and Menu-Title Disabling

The ability to modify programming values can be restricted by installing a lockout jumper on terminals at the rear of the instrument. In addition, certain menu titles can be programmed not to appear during the menu scroll.

Menu titles that can be excluded with *dSPY* menu functions.

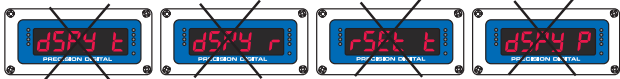

**SEt Pt5** Menu title always appears.

Ability to change values may or may not be restricted

Functions that can be locked out with the lockout jumper.

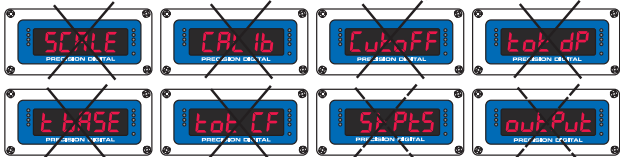

## Large, Bright, Red LEDs

The large, bright, red LED display of this Large Display Process Meter is designed to make it easily read from far away in a dimly lit process plant.

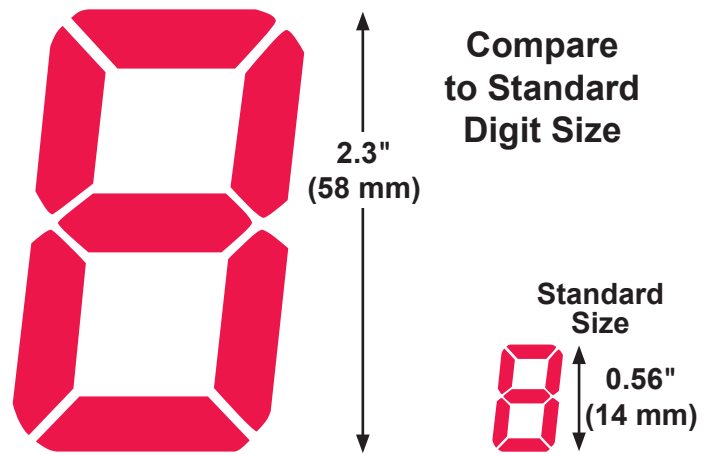

## Simplify Loops with Two 24 V Supplies

The PD650 is ideal for loops that consist of a transmitter, a digital meter and a DCS or computer because it can provide isolated power to drive both the input and output loops.

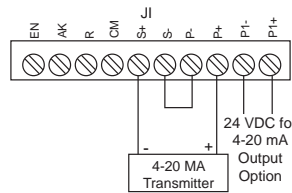

Transmitter Powered from Internal Power Supply

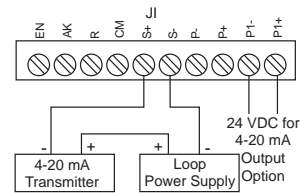

Transmitter Powered from External Power Supply

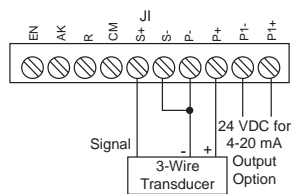

Transducer Powered from Internal Power Supply

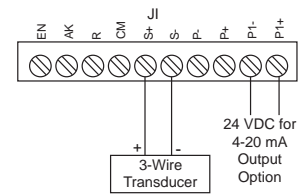

Direct Voltage Signal Connections

## Universal Process Inputs & Linearization

The Large Display Process Meter accepts both voltage and current inputs and can be scaled for virtually any engineering unit. In addition, this meter features automatic square root extraction, programmable exponent for weirs and flumes and 11-point custom calibration.

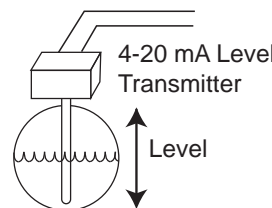

Display volume in a round horizontal tank.

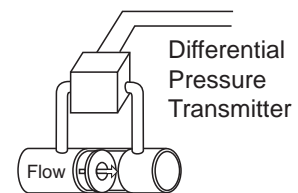

Display flow rate by extracting the square root of a signal from a DP transmitter.

# PD650 Large Display Process Meter

## FLOW FEATURES

The Large Display Process Meter may be used to display flow rate and total from a wide variety of flow meters. For flow rate applications, these meters feature programmable time base of seconds, minutes, hours, or days, a 4½ digit plus extra zero display, and low-flow cutoff capability. For total applications, these meters feature a full six-digit display, a programmable totalizer conversion factor and the ability to automatically or manually toggle back and forth between rate and total display. Signal input conditioning features include programmable exponent for weirs and flumes.

## OPTIONS

The meter can be equipped with 2 or 4 SPDT relays and 4-20 mA output options. Any relay can be assigned to the rate or the total. The 4-20 mA output on provides signal isolation and can be scaled for a wide variety of applications.

### Rate Relays

Rate relays are field programmable as latching or non-latching and 0-100% adjustable deadband. They can be used as high or low alarms or for simple on-off control, such as sump-pump control. Pairs of rate relays can also be programmed to alternate making these meters ideal for duplex pumping applications.

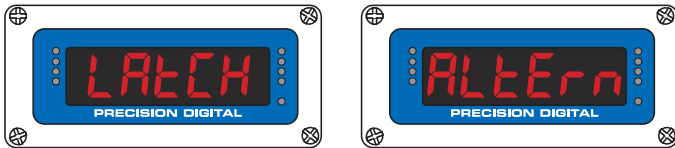

### Total Relays

Total relays can be programmed for manual (E for External Reset) or automatic (I for Internal Reset) batch control. To simplify and speed up batch-size changes, total relays can be programmed so the first preset always trips at a user-defined offset value before the main preset trips. In addition, the Priority Batch Programming feature allows the user to program the batch presets without having to go through the entire menu. Simply hold the ENTER button for three seconds and the meter jumps right to the batch presets.

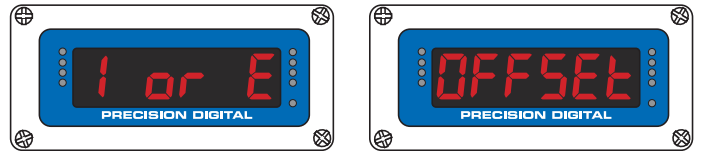

### 4-20 mA Output Option

The meter can be equipped with an isolated 4-20 mA output signal option that can be programmed to produce a 4-20 mA output for virtually any input. This meter also contains two transmitter power supplies, so even if the meter is powering the input loop, it can still power the output loop. The 4-20 mA output provides 500 VDC or peak AC, input-to-output or input/output-to-power isolation.

## PUMP ALTERNATION

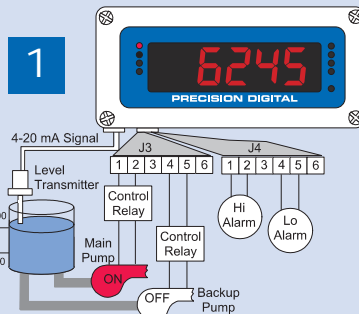

Relay #1 turns the main pump on at 6000 gallons and turns it off at 1000 gallons.

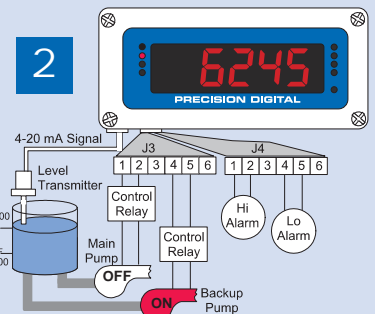

With the Pump Alternation feature activated, the next time the level reaches 6000 gallons, relay #2 transfers and starts the backup pump.

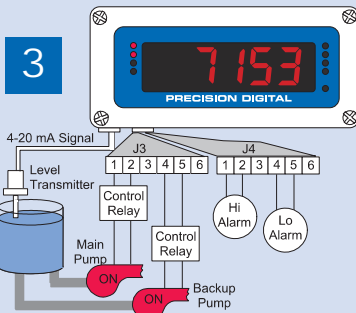

If backup pump is not able to keep up, and the level reaches 7000 gallons, relay #1 transfers and starts the main pump as well.

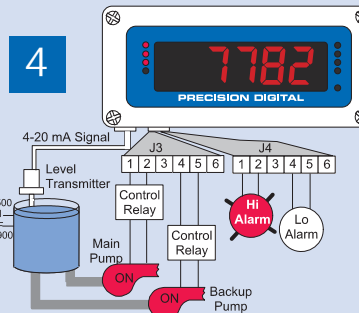

Relay #3 trips the High Level Alarm at 7500 gallons and resets at 6900 gallons.

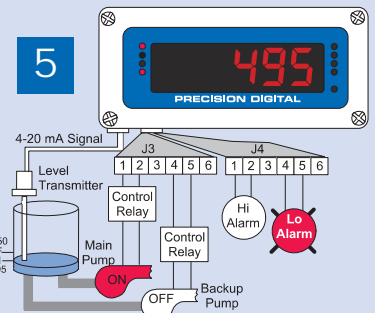

Relay #4 trips the Low Level Alarm at 495 gallons and resets at 750 gallons.

# PD650 Large Display Process Meter

## OVERALL DIMENSIONS

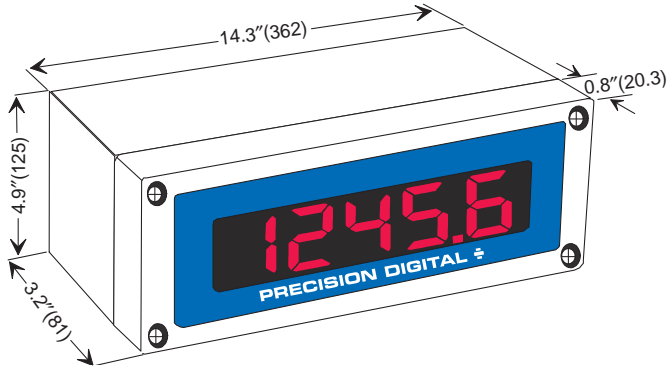

## WALL MOUNTING

There are four mounting holes on the rear of the enclosure that are used to mount the instrument to a wall.

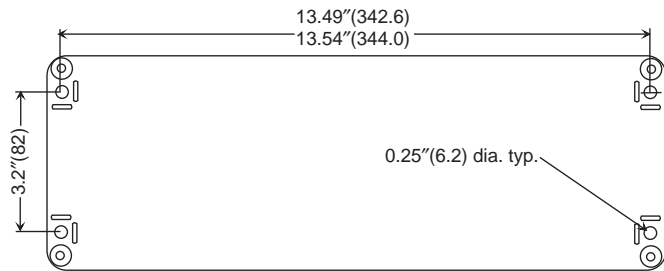

## PANEL MOUNTING

### PD650 Panel Mounting Kit - PDA6504

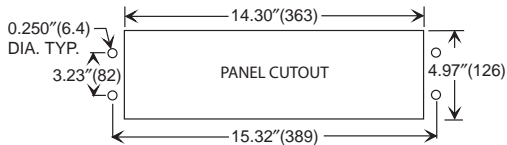
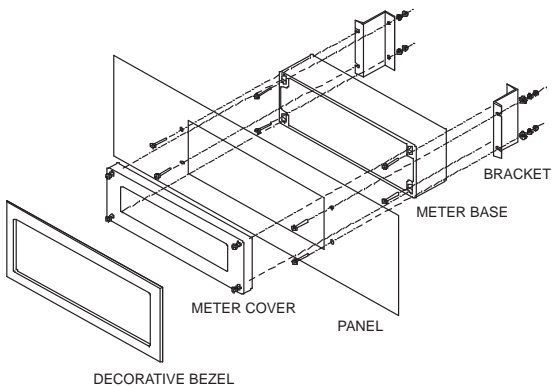

#### NOTES:

1. Allowable panel thickness: 0.06 - 0.25 (1.5 - 6.4). Longer bracket screws may be used for panel thickness up to 0.5 (12.7).
2. Mounting space required: 7 x 17.5 x 4 (178 x 445 x 102) (H x W x D). Meter cover extends 0.8 (20) - X from the surface of the panel, where X equals the thickness of the panel.
3. This panel mounting kit is not intended to provide waterproof protection to the panel.
4. All dimensions are in inches and millimeters (mm).

## Manual Batch Control Operation

This example shows how the PD650 can be used for simple manual batch control.

KEY	
	= VALVE CLOSED
	= VALVE OPEN
	= External Reset Switch
	= External Reset Switch Activated

The valve and External Switch KEY Legend is as shown:

Both valves are open to fill the barrel. Meter displays barrel contents.	
Full-flow valve #1 is closed and restricted-flow valve #2 "dribbles" in the remaining 5 gallons.	
When the total reaches 55.00, relay 2 trips and closes the restricted-flow valve #2. Display freezes on 55.00 and relays 1 and 2 will not reset until external switch is pushed.	
Both valves are still closed and a new barrel is positioned. Meter displays previous barrel's contents until external reset button is pushed.	
Operator presses the external reset switch to reset total. Total goes to zero. Both relays reset causing both valves to open and begin filling the new barrel.	
Both valves are open to fill the barrel. Meter displays barrel contents.	

## Batch Control with Varying Batch Sizes

To simplify batch control applications with varying batch sizes, use one or more switches to control the relay outputs. The switch allows the operator to disable the process when changing presets in the meter and then enable the process after all the changes have been made and the process is ready to resume. The switch serves as a "Stop/Ready" control.

See batch control application note at [www.predig.com](http://www.predig.com).

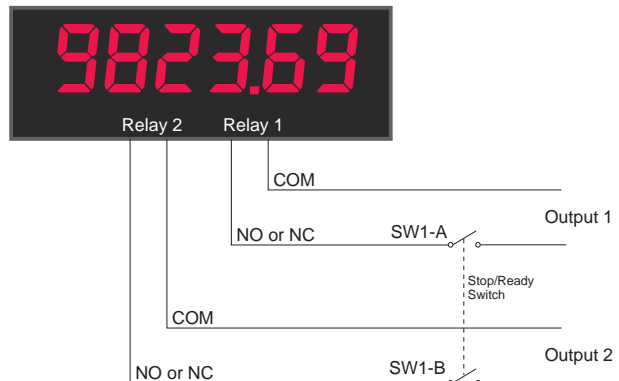

# PD650 Large Display Process Meter

## SPECIFICATIONS

Except where noted all specifications apply to operation at +25°C.

### PD650 NEMA 4X 2.3" Red LED

**Display:** 2.3" (57.3 mm) red LED, 4½ digits.

**Enclosure:** Die-cast aluminum, NEMA 4X, IP66/IP67  
Corrosion resistant, 0.1% max copper content, color: gray (RAL 7001) polyester powder paint. Four holes for ½" conduit provided at base, 3 plugs provided.

**Mounting:** Enclosure contains four ¼" (6.4 mm) holes for wall-mounting. Panel mounting kit available.

**Overall Dimensions:** 4.9" x 14.3" x 3.2" (125 x 362 x 81 mm)

**Weight:** 7.0 lb (3.2 kg)

### General

**Alarm Points:** Four, any combination of high or low alarms

**Alarm Point Deadband:** 0-100% FS, user selectable

**Alarm Status Indication:** Front panel LED

**External Programming:** The Enter button functions can be controlled externally by wiring a switch across terminals EN and CM.

**Non-Volatile Memory:** Settings stored for a minimum of 10 years.

**Normal Mode Rejection:** 64 dB at 50/60 Hz

**Power Options:** AC power: 115 or 230 VAC (field select) ±10%, 50/60 Hz, 12 VA. DC power: 22-28 VDC; 12 W maximum.

**Isolation:** AC powered: 1500 V; DC powered: 500 V

**Connections:** Removable screw terminals accept 12 to 22 AWG

**Warranty:** 2 years parts & labor

### Basic Meter Specifications

**Inputs:** Field selectable: 4-20 mA, 0-20 mA, 0-5 V, 1-5 V, 0-10 V

**Display:** 6 digits, red LED, -19,999(0) to 29,999(0) with selectable extra zero. Total display: 0 to 999,999.

**Decimal Point:** Process/rate: 2.9999, 29.999, 299.99, 2999.9 or 29999.0. Total: 9.99999, 99.9999, 999.999, 9999.99, 99999.9, 999999. Rate and total decimal points are independent.

**Linear Input Accuracy:** ±0.05% FS ±1 count

**Root Function Accuracy:** ±0.1% FS ±2 counts

**Programmable Exponent:** From 1.0001 to 2.9999

**Multi-Point Linearization:** 2 to 11 points

**Calibration:** May be scaled using internal calibration ( $I-εRL$ ) or calibrated by applying an external calibration signal ( $E-εRL$ ). To scale inputs such as 0-5 V, 1-5 V, or 0-10 V without applying a signal it is necessary to first complete an Initial Calibration.

**Calibration Range:** User programmable over entire range of meter

Input Range	Minimum Span Between Input 1 & Input 2
0-5 V.....	0.16 V
0-10 V.....	0.32 V
4-20 mA .....	1.60 mA

**11-Point Linearization:** Minimum span between inputs

Input Range	Minimum Span
4-20 mA	..... (1.6 mA / (Number of points -1))
0-5 V	..... (0.16 V / (Number of points -1))
0-10 V	..... (0.32 V / (Number of points -1))

e.g. Minimum span for an 11-point, 4-20 mA calibration is 0.16 mA between inputs.

**Input Impedance:** Voltage ranges: greater than 300 kΩ; current ranges: 100 Ω

**Transmitter Supply:** Two isolated transmitter supplies, 24 VDC ±5% @ 20 mA each, regulated. Maximum loop resistance: 1200 Ω

**Max (Display Peak):** Captures the maximum or peak process/rate and displays it via the front panel ENTER button ( $dSPY P$ )

**Max Indication:** Front panel flashing "R" LED

**Lockout:** Jumper JP1 labeled "LOCK" restricts modification of programmed settings.

**Operating Temperature:** -20 to 65°C

**Storage Temperature:** -40 to 85°C

**Relative Humidity:** 0 to 90% non-condensing

### Rate/Totalizer/Batch Controller Features

**Rate Display Indication:** LED labeled "R" in lower right illuminates when meter is displaying rate or process input.

**Alternating Display:** Display may be programmed to alternate between rate and total every 10 seconds.

**Low-Flow Cutoff:** Any input below the low-flow cutoff value will result in a display of zero. May be set from 1 count to 100% FS, user selectable. To disable low-flow cutoff, program cutoff value to zero. Totalizer is based on rate display; inputs below the low-flow cutoff value will not affect the totalizer.

**Total Display:** 0 to 999,999, automatic lead zero blanking

**Total Decimal Point:** May be set in any of the following positions: 9.99999, 99.9999, 999.999, 9999.99, 99999.9, 999999.

Total decimal point is independent of process/rate decimal point.

**Time Base:** Seconds, minutes, hours, or days

**Total Conversion Factor:** Programmable from 0.00001 to 59999

**Totalizer:** Calculates total based on rate and field programmable multiplier to display total in engineering units. Total is stored in non-volatile memory.

**Totalizer Rollover:** Totalizer rolls over when total exceeds 999,999. Relay status reflects the display value.

**Totalizer Presets:** Up to four, user selectable under Setup menu. Any set point can be assigned to total and may be programmed anywhere in the range of the meter. Relays assigned to total trip when total reaches the preset value and reset when total is reset to zero or when acknowledged manually. Can be programmed so when the highest preset value is reached the total automatically resets to zero.

**Preset Offset:** Relays that are assigned to total can be programmed to trip at any point below the next relay's preset value. If preset offset mode is selected the corresponding relay will always trip at a programmed offset value before the next relay trips.

*Example:* Set point 1 and 2 are set up for total, with Offset selected (under set point 2). If the preset offset is set at 10, (during Set Points programming for set point 1), then relay 1 will trip 10 counts before relay 2.

**Programmable Delay on Release:** If the meter is programmed to reset total to zero automatically when the highest preset is reached, there will be a delay before the total relays are reset. This delay can be programmed between 1 and 999 seconds.

**Priority Batch Programming:** This feature allows the user to quickly change preset values without going into the main menu by holding the ENTER button for more than 3 seconds.

**Total Reset:** Via front panel ENTER button, external contact closure, or automatically via user selectable preset value.

**Total Reset Lockout:** Meter may be programmed so Total cannot be reset from front panel.



# PD650 Large Display Process Meter

## Relays

**Rating:** 2 or 4 Form C (SPDT); rated 2 A @ 30 VDC or 2 A @ 250 VAC resistive load; 1/14 HP ( $\approx 50$  watts) @ 125/250 VAC inductive loads. Built-in suppression.

**Assign to Process/Rate or Total:** Any relay may be assigned to process/rate or total (process/rate meters).

**Built-in Suppression:** Each relay contact is protected by a built-in suppressor (snubber) to prolong the life of the relays and provide a degree of protection against electrical noise caused by inductive loads. Suppressors value:  $0.01 \mu\text{F}/470 \Omega$ , 250 VAC.

**Deadband:** 0-100% FS, user selectable

**High or Low Alarm:** User may program any alarm for high or low

**Relay Operation:** Latching or non-latching

**Fail-Safe Operation:** Relay coils are energized in non-alarm condition. In case of power failure, relays will go to alarm state. Fail-safe operation may be disabled, by removing jumper J5 located on the options board.

**Auto Initialization:** When power is applied, relays assigned to total will reflect the state of the accumulated Total value in memory. Relays assigned to process/rate or temperature will reflect the state of the input to the meter.

**Relays Reset:** User select via jumper array and *SETUP* menu

**Total Relays Reset** (process/rate meters):

1. When total is reset to zero, if set up for external total reset.
2. After delay has elapsed, if set up for internal total reset.
3. Manual any time, if set up for external total reset. Manual reset resets all manually resettable relays.

**Process/Rate & Temperature Relays Reset:**

Relays assigned to process/rate or temperature may be programmed to reset in any of the following ways:

1. Automatic reset when the input passes the reset point.
2. Manual reset at any time (via user supplied external contact closure at terminals AK and CM or front panel ACK button). Manual reset resets all manually resettable relays.
3. Automatic plus manual reset at any time. Relays will automatically reset when input passes the reset point. Relays can also be manually reset at any time (via user supplied external contact closure at terminals AK and CM or front panel ACK button). Manual reset resets all manually resettable relays.
4. Manual reset only after alarm condition corrected. Relays can be manually reset only after alarm condition has been corrected (via user supplied external contact closure at terminals AK and CM or front panel ACK button). Manual reset resets all manually resettable relays.

## Isolated 4-20 mA Transmitter Output

**Scaling Range:** Anywhere in range of meter, 501 counts minimum span for process/rate meter; reverse scaling allowed.

**Accuracy:**  $\pm 0.1\%$  FS  $\pm 0.004$  mA

**Output Loop Resistance:**

	Loop Resistance	
Power supply	Minimum	Maximum
24 VDC	10 $\Omega$	600 $\Omega$
35 VDC (external)	600 $\Omega$	1000 $\Omega$

**Isolation:** 500 V input-to-output or input/output-to-24 VDC supply

**External Loop Power Supply:** 35 VDC maximum

The PD650 is ideal for loops that consist of a transmitter, a digital meter, and a DCS or computer because they can provide isolated power to drive both the input and output loops.

## Front Panel LED Indicators

LED	During Programming:	During Operation:
1	Alarm 1	Alarm 1
2	Alarm 2	Alarm 2
3	Alarm 3	Alarm 3
4	Alarm 4	Alarm 4
S	Set Point Indicator	None
R	Reset Point Indicator	None
4	4 mA Output Indicator	None
20	20 mA Output Indicator	None
R	Rate Indicator	Rate

## ORDERING INFORMATION

PD650 • Large Display (2.3") Process Meter		
115/230 VAC Model	24 VDC Model	Options Installed
PD650-N	PD650-2-N	None
PD650-34	PD650-2-34	2 Relays
PD650-35	PD650-2-35	4-20 mA Output
PD650-36	PD650-2-36	2 Relays + 4-20 mA Output
PD650-37	PD650-2-37	4 Relays
PD650-38	PD650-2-38	4 Relays + 4-20 mA Output
PD650 Accessories		
PDA6504	Panel Mounting Kit for PD650	

**Your Local Distributor is:**

### Disclaimer

The information contained in this document is subject to change without notice. Precision Digital Corporation makes no representations or warranties with respect to the contents hereof, and specifically disclaims any implied warranties of merchantability or fitness for a particular purpose. ©2008-2016 Precision Digital Corporation. All rights reserved.

LDS650\_B 01/16