

**HELIOS**

# DUAL-LINE LARGE DISPLAY

Readable from up to  
100 Feet (30 Meters) Away

Superluminous Sunlight  
Readable Display

Large 1.80" (46 mm) Digits

Six Full Digits on Each Line

Great for Outdoor Use:  
-40° to 150°F (-40° to 65°C)

IP65 Rated Field/Wall  
Mount Enclosure

Free USB Programming  
Software & Cable



**HELIOS**



The only large display meter with a dual-line display  
so bright it can be read in direct sunlight.

[www.predig.com](http://www.predig.com)

**PRECISION  
DIGITAL**

# TABLE OF CONTENTS

4

Benefits of the Helios Series

5

Helios Series Overview

7

Helios Series Specifications

8

Helios Series Products

15

Helios Programming Software

Actual size display shown ▶

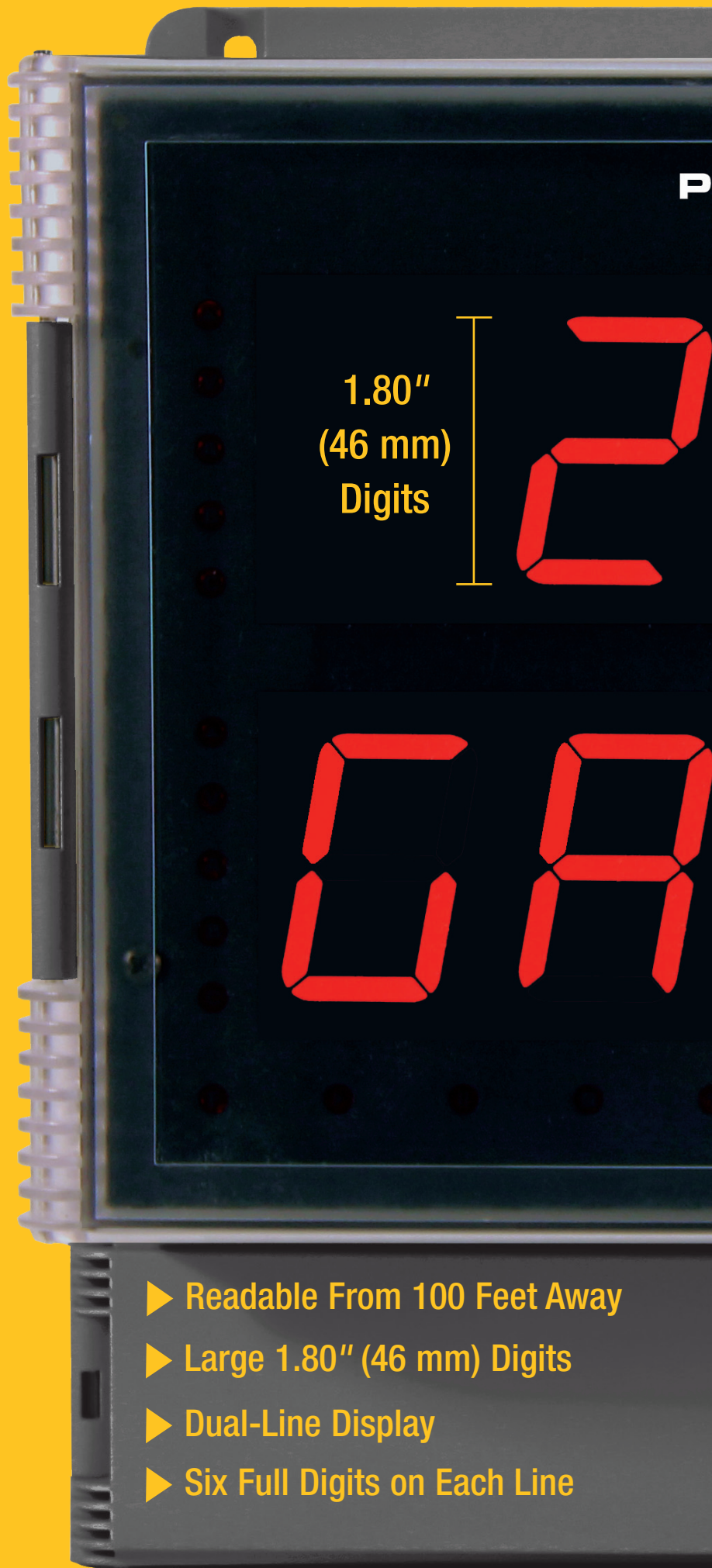



- ▶ Readable From 100 Feet Away
- ▶ Large 1.80" (46 mm) Digits
- ▶ Dual-Line Display
- ▶ Six Full Digits on Each Line



**PRECISION DIGITAL** 

600.0

 **Dual-Line Display** 

LL0n

2

P-001-11

- ▶ Superluminous Sunlight Readable Display
- ▶ Great For Outdoor Use: -40° to 150°F (-40° to 65°C)
- ▶ IP65 Rated Field/Wall Mount Enclosure
- ▶ Free USB Programming Software & Cable

## What Makes a Dual-Line Display So Great?

- › Display One Input in Two Different Scales
- › Display Input and Tag
- › Display Flow Rate and Total at Same Time
- › Display Two Inputs at Same Time
- › Keep Track of Where You Are While Programming

## What Makes the Helios a Great Outdoor Meter?

- › Read it Even in Bright Sunshine
- › Read it From 100 Feet Away
- › Fully Enclosed IP65 Rated Enclosure
- › Use it Over Temperature Ranges of -40 to 150°F
- › Mount it Easily on Walls or Pipes



## Helios Applications

- › Tank Level
- › Pump Control
- › Temperature
- › Pressure
- › Weight / Scale
- › Flow Rate / Totalizers
- › Speed
- › Batch Control
- › Motor Voltage & Current
- › Just About Anything You Want!

## Helios Inputs

- › 4-20 mA
- › Thermocouple & RTD
- › Pulse
- › Strain Gauge
- › AC Volts & Current
- › Modbus



# HELIOS SERIES OVERVIEW



UV Resistant Sunlight Readable Display



IP65 Rated Enclosure

Extra-Large 1.8" Digits

Alarm Status Indicators

PV, Max (Peak), Min (Valley)

Dual-Line 6-Character Display

User Configurable Display

On-Board USB Programming Software  
No need to download.  
Software updates available over the internet.



## INTRODUCTION

What sets the Helios apart from other Large Display Meters is its dual-line display with super bright LEDs that can be read even in bright sunlight. The dual-line display simplifies programming and also makes it possible to display more information. For instance, the upper line can display the process variable and the lower line a tag or a different scale of the input. In a flow application, one line could display flow rate and the other line flow total. Even if you are not installing the Helios outdoors in bright sunlight, you will appreciate its big, clear, bright display that can be seen from up to distances of 100 feet (30 meters).

One other useful feature of the Helios' dual-line display is that each line is a full six digits, thus making it possible to display up to 999,999 gallons in a level application, for instance.

The Helios series is based on PDC's popular line of ProVu® digital panel meters and can satisfy a wide variety of level, flow, temperature, pressure, & weight applications. It is available with models that accept 4-20 mA, thermocouple, RTD, pulse, strain gauge, AC and DC volts and current, and even Modbus®. There are even models with a custom display that shows level in feet and inches. To simplify ordering, all Helios' come with built in sensor excitation, RS-485 Modbus communications, and free programming software. The only choice to make after the input is selected is power and no options or four relays and 4-20 mA.

## KEY FEATURES

### Superluminous Sunlight Readable Display

Helios' standard SunBright display features extraordinarily bright LEDs. It is perfect for applications where the meter is in direct sunlight or in applications where visibility may be impaired by smoke, fog, dust, or distance.

## Great for Outdoor Applications

The Helios' rugged IP65 rated field/wall mountable enclosure and wide operating temperature range of -40 to 150°F makes it an ideal instrument for outdoor applications. The IP65 rated enclosure will protect the instrument from water, dirt, dust, and other contaminants. The wide operating temperature range means the Helios can be installed in deserts and the far north.

## Precise, Accurate, and More Informative

The Helios' large 1.8" display provides a highly accurate and precise dual-line, 6-digit view of the process measurement. Its 24-bit A/D is accurate to ±0.03% of calibrated span ±1 count.

## Free USB Programming Software

The Helios comes with free programming software that connects to your PC with a standard USB cable that is provided with each instrument. A new and very useful feature of this software is that it is resident on the Helios meter and installed directly into your PC. This eliminates the need to install drivers or download software from the internet. Just connect the Helios to your PC (the Helios even gets its power from the PC so you don't have to provide external power!) and within minutes you will be programming it with the free software. **See more details on page 15.**



## Easy to Program

The user friendly dual-line display makes the Helios easy to set up & program with its programming buttons located behind the front door panel. There are three levels of password protection to help maintain the integrity of the programming and there are no jumpers to set for the meter input selection.



Input Setup



Display Setup

## Display What You Want

As indicated below, the Helios' display can be set up for a variety of applications. It has a rather unique and very flexible dual-scale capability; a second scaled display can represent the measured input in a different form (e.g. gallons & height). In the four examples below the upper left meter displays flow rate and total, the upper right meter displays two separate inputs, the lower left meter displays level in feet & inches on the upper line and volume on the lower line, and lastly, the lower right meter displays a process variable on the upper line and units (PSI) on the lower line. The dual-scale feature has been used for a number of application requirements, such as level, pressure & force, current & power, feet & meters, GPM & CFM, and more.



Flow Rate & Total



Two Inputs



Feet/Inches & Volume



Pressure Display

## Advanced Linearization Capability

Many Helios instruments include a variety of special linearization capabilities, such as the ability to apply 32 calibration points of linearization, automatic round horizontal tank volume measurement, square root extraction and programmable exponent linearization for open channel flow measurement. And, all of these capabilities can be programmed with the free USB programming software, so no need to enter in 32 calibration points by hand! The software can even store these configurations and be downloaded into other Helios meters.

## On-Board Digital Inputs and Outputs

The Helios includes five (5) digital inputs and four (4) digital outputs standard. Since the Helios is a large display meter it is often mounted in areas where it is not convenient to access the programming buttons. The digital inputs can be set up to mimic the four programming buttons on the Helios meter, thus making it possible to mount remote buttons for programming in a more convenient location. In addition, the digital inputs can also be used to reset the total, operate the tare feature, reset the tare, and more. The digital outputs can be used to drive alarming devices or as a means to communicate alarm conditions with a PLC.

## Function Keys

There are three function keys available to the user. These keys can be programmed to trigger certain events (i.e. acknowledge alarms, reset max and/or min, disable/enable output relays, or hold current relay states), provide direct menu access points, and more.

## Four Relays and 4-20 mA Output Option

There is only one option (beyond power) for the Helios meters and it consists of four SPDT Form C relays and a 4-20 mA output. The four relays are rated at 3 Amps and can be programmed for a variety of applications. For instance, each relay has 0-100% deadband and can be programmed to trip on High or Low alarm. There are multiple reset modes including automatic, automatic plus manual and manual. The relays can also be set up to alternate or act as sampling relays. The 4-20 mA output option is particularly useful for applications involving pulse, temperature, strain gauge or AC & DC volts, as the Helios meter can act as a convenient way to convert those signals to a 4-20 mA signal.

## Mounting Options

### Pipe Mounting:

The meter can also be mounted to a pipe using the optional pipe mounting kit (PDA6260). This kit includes two mounting plates, two U-bolts, and the necessary nuts and bolts.

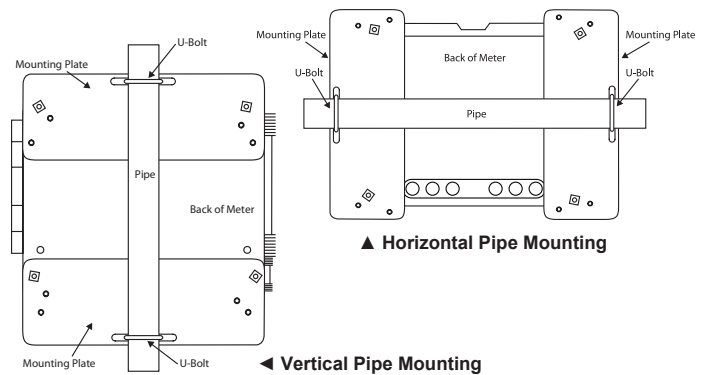

### Wall Mounting:

The meter can be mounted to any wall using the four provided mounting holes. Note that the bottom mounting holes are located underneath the front door panel.

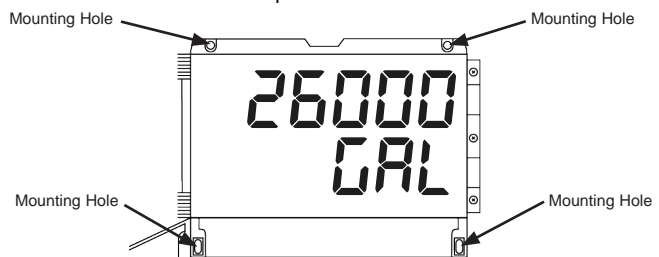

# HELIOS SERIES SPECIFICATIONS

## General

**Display:** Two lines with 1.8" (46 mm) high digits, red LEDs; 6 digits per line (-99999 to 999999), with lead zero blanking  
**Display Intensity:** Eight user selectable intensity levels  
**Display Assignment:** Line 1 and line 2 may be assigned to PV1, PV2, PCT, d r-u, d gross, d nt-g, max/min, max & min, set points, units (line 2 only), rate, total, grand total, batch count or Modbus input.

**Programming Methods:** Four programming buttons, digital inputs, PC and MeterView Pro software, Modbus registers.

**Power Options:** 85-265 VAC 50/60 Hz, 90-265 VDC, 20 W max or 12-24 VDC  $\pm$  10%, 15 W max. Powered over USB for configuration only.

**Environmental:** Operating temperature range: -40 to 150°F (-40 to 65°C); Storage temperature range: -40 to 185°F (-40 to 85°C); Relative humidity: 0 to 90% non-condensing

**Mounting:** *Wall Mounting:* Four (4) mounting holes provided for mounting meter to wall. *Pipe Mounting:* Optional pipe mounting kit (PDA6260) allows for pipe mounting.

**Overall Dimensions:** 10.63" x 12.59" x 4.77" (270 mm x 319.7 mm x 121.2 mm) (W x H x D)

**Warranty:** 3 years parts & labor

**USB Connection:** Compatibility: USB 2.0 Standard, Compliant Connector Type: Micro-B receptacle

Cable: USB A Male to Micro-B Cable supplied

Driver: Windows 98/SE, ME, 2000, Server 2003/2008, XP 32/64-Bit, Vista 32/64-Bit, Windows 7 32/64-Bit, Windows 10 32/64-Bit

Power: USB Port

## Isolated 4-20 mA Transmitter Output

**Output Source:** Process variable (PV), max, min, set points 1-4, Modbus input, total, grand total, or manual control mode

**Scaling Range:** 1.000 to 23.000 mA for any display range

**Calibration:** Factory calibrated: 4.000 to 20.000 = 4-20 mA output  
**Analog Output Programming:** 23.000 mA maximum for all parameters: Overage, underrange, max, min, and break

**Accuracy:**  $\pm$  0.1% of span  $\pm$  0.004 mA

**Temperature Drift:** 0.4  $\mu$ A/°C max from 0 to 65°C ambient, 0.8  $\mu$ A/°C max from -40 to 0°C ambient.

*Note: Analog output drift is separate from input drift.*

**Isolated Transmitter Power Supply:** Terminals I+ & R: 24 VDC  $\pm$  10%. Isolated from the input at >500 V. May be used to power the 4-20 mA output or other devices.

All models rated @ 40 mA max.

**External Loop Power Supply:** 35 VDC maximum

**Output Loop Resistance:** For a 24 VDC power supply: 10  $\Omega$  minimum and 700  $\Omega$  maximum; for a 35 VDC power supply (external): 100  $\Omega$  minimum and 1200  $\Omega$  maximum.

## Relays

**Rating:** Four (4) SPDT (Form C) internal; rated 3 A @ 30 VDC and 125/250 VAC resistive load; 1/14 HP ( $\approx$  50 W) @ 125/250 VAC for inductive loads

**Deadband:** 0-100% of span, user programmable

**High Or Low Alarm:** User may program any alarm for high or low trip point. Unused alarm LEDs and relays may be disabled (turn off).

**Relay Operation:**

1. Automatic (non-latching) and/or manual reset
2. Latching (requires manual acknowledge) with/without clear
3. Pump alternation control (2 to 4 relays)
4. Sampling (based on time)
5. Off (disable unused relays and enable Interlock feature)
6. Manual on/off control mode

**Relay Reset:**

User selectable via front panel buttons or digital inputs

1. Automatic reset only (non-latching), when the input passes the reset point.
2. Automatic + manual reset at any time (non-latching)
3. Manual reset only, at any time (latching)
4. Manual reset only after alarm condition has cleared (latching)

*Note: The programmable function keys or digital input may be assigned to acknowledge relays programmed for manual reset.*

**Time Delay:** 0 to 999.9 seconds, on & off relay time delays; Programmable and independent for each relay

## Dimensions

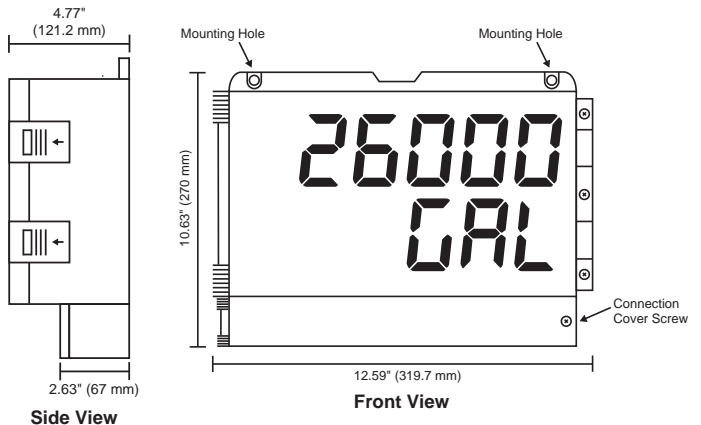

## Connections for Typical Helios Large Display Meters

(PD2-6000-6H7 Shown)

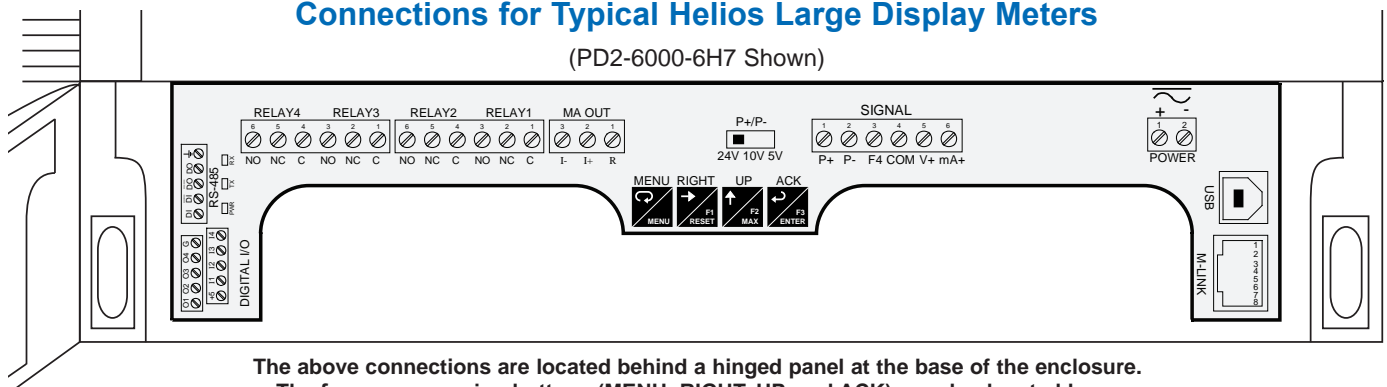

The above connections are located behind a hinged panel at the base of the enclosure.  
 The four programming buttons (MENU, RIGHT, UP, and ACK) are also located here.



## PD2-6000

Helios Process Meter

PROCESS

### Input

0-20 mA, 4-20 mA, 0-5 V, 1-5 V, and  $\pm 10$  V

### Features

- Isolated 24 VDC @ 200 mA Transmitter Power Supply
- Multi-Pump Alternation Control
- Display One Input in Two Different Scales (e.g. Height & Volume)
- Signal Input Conditioning for Flow & Round Horizontal Tank
- 32-Point, Square Root, or Exponential Linearization
- Current Input Protected by Resettable Fuse
- Tare Function

### Why Buy This Product?

Go with the Helios PD2-6000 when you need a large display meter to display the 4-20 mA output from any transmitter you might have. The PD2-6000 can display that output in six full digits and will also provide the 24 VDC to power the transmitter. The PD2-6000's IP65 rated enclosure, super bright LEDs, and wide operating temperature range make it perfect for outdoor applications. The PD2-6000 can also be equipped with a 4-20 mA output as well as four relays that can be used for alarming or control applications, including pump alternation control.



### Ordering Guide

85-265 VAC Model	12-24 VDC Model	Options Installed
PD2-6000-6H0	PD2-6000-7H0	No options
PD2-6000-6H7	PD2-6000-7H7	4 relays & 4-20 mA output

## PD2-6001

Helios Feet & Inches Level Meter

FEET & INCHES



### Input

0-20 mA, 4-20 mA, 0-5 V, 1-5 V, and  $\pm 10$  V

### Features

- Feet & Inches Display Ideal for Level Applications
- Isolated 24 VDC @ 200 mA Transmitter Power Supply
- Multi-Pump Alternation Control
- Display a Single Input in Two Different Scales (e.g. Height & Volume)
- Signal Input Conditioning for Oddly Shaped and Round Horizontal Tanks
- 32-Point, Square Root, or Exponential Linearization

### Why Buy This Product?

Go with the Helios PD2-6001 when you prefer to read level in feet and inches instead of the more common decimal format. This unique display will read up to 99 feet, 11 & 15/16s inches on the upper line. The lower line can display a tag or volume, even from non-linear tanks such as round horizontal ones. The PD2-6001 makes a great outdoor tank side indicator because its display is bright enough to read in direct sunlight and it will operate from -40 to 150°F. The PD2-6001 can also be equipped with a 4-20 mA output as well as four relays that can be used for alarming or controlling applications, including pump alternation control.

### Ordering Guide

85-265 VAC Model	12-24 VDC Model	Options Installed
PD2-6001-6H0	PD2-6001-7H0	No options
PD2-6001-6H7	PD2-6001-7H7	4 relays & 4-20 mA output



## PD2-6060

Helios Dual-Input Process Meter

**DUAL-INPUT**  
PROCESS

### Input

Two (2) 0-20 mA, 4-20 mA, 0-5 V, 1-5 V, and  $\pm 10$  V

### Features

- Displays Two Process Inputs Simultaneously
- Math Functions Capabilities
- Isolated 24 VDC @ 200 mA Transmitter Power Supply
- Multi-Pump Alternation Control
- Signal Input Conditioning for Flow & Round Horizontal Tank
- Programmable Displays & Function Keys
- 32-Point, Square Root, or Exponential Linearization
- Current Input Protected by Resettable Fuse
- Tare Function

### Why Buy This Product?

Go with the Helios PD2-6060 when you need a large display meter to display two 4-20 mA inputs on one meter. Both of these inputs can be displayed on six full digits. The PD2-6060 can also perform a variety of math functions on those two inputs, such as computing the difference between them or summing them together.



### Ordering Guide

85-265 VAC Model	12-24 VDC Model	Options Installed
PD2-6060-6H0	PD2-6060-7H0	No options
PD2-6060-6H7	PD2-6060-7H7	4 relays & 4-20 mA output

## PD2-6080

Helios Modbus Scanner

**MODBUS SCANNER**



### Input

Modbus® RTU;  
Two (2) 0-20 mA, 4-20 mA, 0-5 V, 1-5 V, and  $\pm 10$  V

### Features

- Modbus® RTU Master, Slave, or Snooper Mode
- Poll and Display up to 16 Process Variables
- Math Functions Capabilities
- Isolated 24 VDC @ 200 mA Transmitter Power Supply
- Multi-Pump Alternation Control
- Signal Input Conditioning for Flow & Round Horizontal Tank
- Programmable Displays & Function Keys
- 32-Point, Square Root, or Exponential Linearization
- Up to Three 4-20 mA Analog Outputs Available
- Current Input Protected by Resettable Fuse

### Why Buy This Product?

Go with the Helios PD2-6080 when you have multiple (up to 16), Modbus registers you want to display on a single large display meter. The PD2-6080 can also accept two 4-20 mA signals. The PD2-6080 can be programmed as a Modbus RTU Master, Slave or Snooper allowing it to work in just about any Modbus application. Typically, the upper line displays the PV and the lower line displays the tag.

### Ordering Guide

85-265 VAC Model	12-24 VDC Model	Options Installed
PD2-6080-6H0	PD2-6080-7H0	No options
PD2-6080-6H7	PD2-6080-7H7	4 relays & 4-20 mA output

## PD2-6081

Helios Feet & Inches Modbus Scanner

**MODBUS SCANNER**  
FEET & INCHES

### Input

Modbus® RTU;  
Two (2) 0-20 mA, 4-20 mA, 0-5 V, 1-5 V, and ±10 V

### Features

- Modbus® RTU Master, Slave, or Snooper Mode
- Poll and Display up to 16 Process Variables
- Feet & Inches Display Ideal for Level Applications
- Math Functions Capabilities
- Isolated 24 VDC @ 200 mA Transmitter Power Supply
- Multi-Pump Alternation Control
- Signal Input Conditioning for Oddly Shaped and Round Horizontal Tanks

### Why Buy This Product?

Go with the Helios PD2-6081 when you have a level application involving Modbus signals and you prefer to display in feet and inches instead of the more common decimal format. The PD2-6081 can display up to 16 modbus registers so a typical application might be 16 tank levels, 8 tank levels and 8 interface levels, or 5 tank levels, 5 interface levels and 5 temperatures. The PD2-6081 makes a great outdoor tank side indicator because its display is bright enough to read in direct sunlight and it will operate from -40 to 150°F.



### Ordering Guide

85-265 VAC Model	12-24 VDC Model	Options Installed
PD2-6081-6H0	PD2-6081-7H0	No options
PD2-6081-6H7	PD2-6081-7H7	4 relays & 4-20 mA output

## PD2-6100

Helios Strain Gauge Meter

**STRAIN GAUGE**



### Input

15, 30, 150, 300 mV Unipolar Input Ranges;  
±15, ±25, ±150, ±250 mV Bipolar Input Ranges

### Features

- Selectable 5 or 10 VDC Sensor Excitation
- Supports up to Twelve (12) 350 Ω Load Cells (Minimum Load Resistance of 28 Ω)
- Capture or Programmable Tare Feature
- Auto-Zero Feature Eliminates Zero Drift
- Ratiometric Operation
- Max/Min or Peak/Valley Hold Feature
- Display One Input in Two Different Scales (e.g. Weight & Volume)
- Rounding Function 1, 2, 5, 10, 20, 50, or 100

### Why Buy This Product?

Go with the Helios PD2-6100 when you have a weighing application where you need to read the display from a distance, or outside in the bright sunlight in temperatures between -40 to 150°F. The PD2-6100 tare feature can be used to remove the weight of the container from the weight calculation. You can even re-transmit the weight signal with the PD2-6100's optional 4-20 mA output.

### Ordering Guide

85-265 VAC Model	12-24 VDC Model	Options Installed
PD2-6100-6H0	PD2-6100-7H0	No options
PD2-6100-6H7	PD2-6100-7H7	4 relays & 4-20 mA output



## PD2-6200

Helios Analog Input Flow Rate/Totalizer

FLOW RATE/TOTAL

### Input

0-20 mA, 4-20 mA, 0-5 V, 1-5 V, and  $\pm 10$  V

### Features

- Isolated 24 VDC @ 200 mA Transmitter Power Supply
- Displays Rate and Total Simultaneously
- Count Up or Down, Total & Grand Total
- Open Channel Flow with Programmable Exponent
- Non-Resettable Grand Total
- 32-Point Linearization
- Current Input Protected by Resettable Fuse
- On-Board Digital Input (for Remote Reset)

### Why Buy This Product?

Go with the Helios PD2-6200 when you want to display both flow rate and total at the same time from a 4-20 mA output flowmeter. The PD2-6200 can display both flow rate and total in six full digits and can also be configured to display non-resettable grand total. The PD2-6200 can even display open channel flow using its programmable exponent function. The PD2-6200's IP65 rated enclosure, super bright LEDs, and wide operating temperature range make it perfect for outdoor applications.



### Ordering Guide

85-265 VAC Model	12-24 VDC Model	Options Installed
PD2-6200-6H0	PD2-6200-7H0	No options
PD2-6200-6H7	PD2-6200-7H7	4 relays & 4-20 mA output

## PD2-6210

Helios Analog Input Batch Controller

BATCH CONTROL



### Input

0-20 mA, 4-20 mA, 0-5 V, 1-5 V, and  $\pm 10$  V

### Features

- Isolated 24 VDC @ 200 mA Transmitter Power Supply
- Start, Batch, Pause, & Stop with Front Panel Buttons
- Display Batch Total + Rate, Grand Total, Batch Count or Preset
- Single or Multi-Stage Batching with up to 4 Relays
- Automatic Overflow Protection
- Manual Control or Automatic Batching
- Current Input Protected by Resettable Fuse
- On-Board Digital Input (for Remote Reset)
- Count Up or Down, Total & Grand Total

### Why Buy This Product?

Go with the Helios PD2-6210 when you need to do batch controlling using a 4-20 mA output flowmeter. The PD2-6210's huge display means operators don't have to be close up to the instrument to monitor the status of the batching application. And its IP65 rated enclosure allows the PD2-6210 to be mounted in wet, dusty, and dirty areas. The PD2-6210 can handle single and multi-stage batching applications.

### Ordering Guide

85-265 VAC Model	12-24 VDC Model	Options Installed
PD2-6210-6H2	PD2-6210-7H2	2 relays
PD2-6210-6H7	PD2-6210-7H7	4 relays & 4-20 mA output

## PD2-6262

Helios Analog Dual-Input Rate/Totalizer

**DUAL-INPUT**  
RATE / TOTALIZER

### Input

Two (2) 0-20 mA, 4-20 mA, 0-5 V, 1-5 V, and  $\pm 10$  V

### Features

- Displays Two Flow Inputs Simultaneously
- Displays Rate and Total Simultaneously
- Math Functions Capabilities
- Isolated 24 VDC @ 200 mA Transmitter Power Supply
- Count Up or Down, Total & Grand Total
- Open Chanel Flow with Programmable Exponent
- Non-Resetable Grand Total
- 32-Point Linearization
- Current Input Protected by Resettable Fuse
- On-Board Digital Input (for Remote Reset)



### Why Buy This Product?

Go with the Helios PD2-6262 when you want to display two 4-20 mA flowmeter inputs on one meter. Both of these inputs can be displayed on six full digits. The PD2-6262 can also perform a variety of math functions on those two inputs, such as computing the difference between them or summing them together. One application for the PD6262 is determining fuel consumption by computing the difference between two flowmeter inputs.

### Ordering Guide

85-265 VAC Model	12-24 VDC Model	Options Installed
PD2-6262-6H0	PD2-6262-7H0	No options
PD2-6262-6H7	PD2-6262-7H7	4 relays & 4-20 mA output

## PD2-6300

Helios Pulse Input Flow Rate/Totalizer

**FLOW RATE/TOTAL**



### Input

Pulse, Open Collector, NPN, PNP, TTL, Switch Contact, Sine Wave (Coil), Square Wave

### Features

- 5, 10, or 24 V Flowmeter Power Supply
- Displays Rate and Total Simultaneously
- Count Up or Down, Total & Grand Total
- Gate Function for Rate Display of Slow Pulse Rates
- K-Factor, Internal Scaling, or External Calibration
- Non-Resetable Grand Total
- 32-Point Linearization
- On-Board Digital Input (for Remote Reset)
- Can Convert Pulse Input to an Isolated 4-20 mA Output

### Why Buy This Product?

Go with the Helios PD2-6300 when you want to display both flow rate and total at the same time from a pulse output flowmeter. The PD2-6300 can display both flow rate and total in six full digits and can also be configured to display non-resettable grand total. The PD2-6300's IP65 rated enclosure, super bright LEDs, and wide operating temperature range make it perfect for outdoor applications.

### Ordering Guide

85-265 VAC Model	12-24 VDC Model	Options Installed
PD2-6300-6H0	PD2-6300-7H0	No options
PD2-6300-6H7	PD2-6300-7H7	4 relays & 4-20 mA output



## PD2-6310

Helios Pulse Input Batch Controller

**BATCH CONTROL**

### Input

Pulse, Open Collector, NPN, PNP, TTL, Switch Contact, Sine Wave (Coil), Square Wave

### Features

- 5, 10, or 24 V Flowmeter Power Supply
- K-Factor, Internal Scaling, or External Calibration
- Start, Batch, Pause, & Stop with Front Panel Buttons
- Display Batch Total + Rate, Grand Total, Batch Count or Preset
- Single or Multi-Stage Batching with up to 4 Relays
- Automatic Overflow Protection
- Manual Control or Automatic Batching
- 32-Point Linearization

### Why Buy This Product?

Go with the Helios PD2-6310 when you need to do batch controlling using a pulse output flowmeter. The PD2-6310's huge display means operators don't have to be close up to the instrument to monitor the status of the batching application. And its IP65 rated enclosure allows the PD2-6310 to be mounted in wet, dusty, and dirty areas. The PD2-6310 can handle single and multi-stage batching applications.



### Ordering Guide

85-265 VAC Model	12-24 VDC Model	Options Installed
PD2-6310-6H2	PD2-6310-7H2	2 relays
PD2-6310-6H7	PD2-6310-7H7	4 relays & 4-20 mA output

## PD2-6363

Helios Pulse Dual-Input Rate/Totalizer

**DUAL-INPUT**  
RATE / TOTALIZER



### Input

Two (2) Pulse, Open Collector, NPN, PNP, TTL, Switch Contact, Sine Wave (Coil), Square Wave

### Features

- Displays Two Flow Inputs Simultaneously
- Displays Rate and Total Simultaneously
- Math Functions Capabilities
- 5, 10, or 24 V Flowmeter Power Supply
- Count Up or Down, Total & Grand Total
- Gate Function for Rate Display of Slow Pulse Rates
- K-Factor, Internal Scaling, or External Calibration
- Non-Resetable Grand Total

### Why Buy This Product?

Go with the Helios PD2-6363 when you want to display two pulse flowmeter inputs on one meter you can see from a distance. Both of these inputs can be displayed on six full digits. The PD2-6363 can also perform a variety of math functions on those two inputs, such as computing the difference between them or summing them together. One application for the PD6363 is determining fuel consumption by computing the difference between two flowmeter inputs.

### Ordering Guide

85-265 VAC Model	12-24 VDC Model	Options Installed
PD2-6363-6H0	PD2-6363-7H0	No options
PD2-6363-6H7	PD2-6363-7H7	4 relays & 4-20 mA output

## PD2-6400

Helios High Voltage & Current Meter

**HIGH VOLTAGE & CURRENT**

### Input

High Voltage: (Channel V) 0-300 VDC or VAC;  
High Current: (Channel A) 0-5 AAC or ADC;  
Both Switch Selectable.

### Features

- Displays Voltage and Current Simultaneously
- Multiplication for Apparent Power Calculation
- Up to Three 4-20 mA Analog Outputs Available

### Why Buy This Product?

Go with the Helios PD2-6400 when you want to display voltage and current on one large display meter you can see from a distance. The PD2-6400 can even compute and display apparent power by multiplying the two inputs together.



### Ordering Guide

85-265 VAC Model	12-24 VDC Model	Options Installed
PD2-6400-6H0	PD2-6400-7H0	No options
PD2-6400-6H7	PD2-6400-7H7	4 relays & 4-20 mA output

## PD2-7000

Helios Temperature Meter

**TEMPERATURE**



### Input

Thermocouple: J, K, T, E, R, S, B, N, C;  
RTD: 100Ω Pt, 10Ω Cu, 120Ω Ni, 1000Ω Pt

### Features

- 1° or 0.1° Resolution
- Displays up to 3300°F
- Averages Up To 10 RTD Sensors
- Automatic Cold Junction Compensation

### Why Buy This Product?

Go with the Helios PD2-7000 when you want to display temperature on a large display meter you can see from a distance. The PD2-7000 can accept a variety of thermocouples and RTDs and displays temperature on a six digit display. The PD2-7000's IP65 rated enclosure, super bright LEDs, and wide operating temperature range make it perfect for outdoor applications.

### Ordering Guide

85-265 VAC Model	12-24 VDC Model	Options Installed
PD2-7000-6H0	PD2-7000-7H0	No options
PD2-7000-6H7	PD2-7000-7H7	4 relays & 4-20 mA output



## FREE Programming Software for the Helios with Easy USB Hook-Up



▲ Easily connect the Helios to your computer with the USB cable to install the software and you'll be up and running in no time!



### MeterView Pro® Software For Helios Large Display Meters

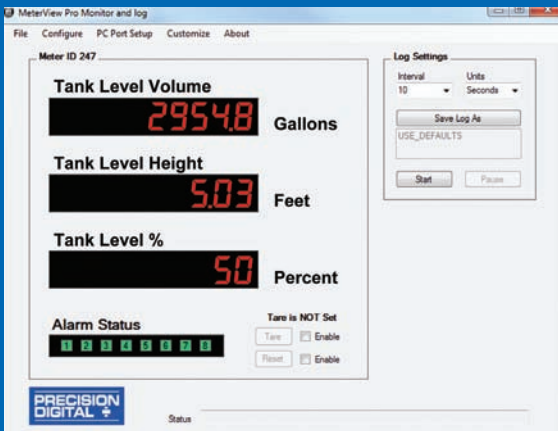

#### QUICK OVERVIEW

System Requirements: Windows® 2000, XP, Vista, 7, 8, 10  
 Communications: One meter at a time: USB, RS-232, or RS-485  
 Meter Address: 1 - 247  
 Reports: Data logging: Save as CSV file format  
 Configuration: Save as PDC file format or print configuration  
 Baud Rate: 300 - 19,200 bps  
**Configuration:** Modbus RTU

#### FEATURES

- Simple USB Hook-Up
- Configure the meter
- Monitor present trends
- Log to as large of a file as needed



### ScanView Software For Helios Modbus Scanners



#### QUICK OVERVIEW

System Requirements: Windows® 2000, XP, Vista, 7, 8, 10  
 Meter Address: 1 - 247  
 PV Slave ID: 1-247, 256-259 for on-board current & voltage inputs  
 Reports: Data logging: Save as CSV file format  
 Configuration: Save as MVP file format or print configuration  
 Baud Rate: 300 - 19,200 bps  
**Configuration:** One meter at a time  
 Protocol: Modbus RTU

#### FEATURES

- Use in Modbus master, slave, or snooter mode
- Scan up to 16 Modbus process variables
- Monitor critical process information
- Manage relays and analog outputs
- Independent scaling, tag, and unit for each PV
- Data log all PVs to a PC

# contact us



U.S. & Canada  
1-800-343-1001

International  
1-508-655-7300



Tech Support  
support@predig.com

Sales  
sales@predig.com



Message / Live Chat  
www.predig.com



Corporate Office  
233 South St • Hopkinton, MA 01748 USA



Fax  
1-508-655-8990

**Your Local Distributor is:**

#### Disclaimer

The information contained in this document is subject to change and correction without notice. Precision Digital Corporation makes no representations or warranties with respect to the contents hereof, and specifically disclaims any implied warranties of merchantability or fitness for a particular purpose.

©2016-2017 Precision Digital Corporation. All rights reserved.

LMDHELIOS\_B 02/17



[www.predig.com](http://www.predig.com)

**PRECISION DIGITAL CORPORATION**