

PD2-6001

Large Display Feet & Inches Process Meter

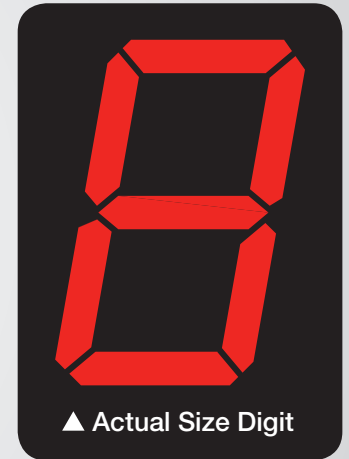

HELIOS



FEET & INCHES PROCESS

- Feet & Inches Display Ideal for Level Applications
- Large 1.80" Dual-Line 6-Digit Display Readable from up to 100 Feet Away
- Superluminous Sunlight Readable Display
- NEMA 4X, IP65 Rated Field Mountable Enclosure
- 0-20 mA, 4-20 mA, 0-5 V, 1-5 V, and ± 10 V Inputs
- Universal 85-265 VAC, or 12-24 VDC Input Power Models
- Dual-Scale for some Level Applications – Single Input
- Isolated 24 VDC Transmitter Power Supply
- Signal Input Conditioning for Round Horizontal Tanks
- Programmable Display & Function Keys
- 32-Point, Square Root, or Exponential Linearization
- Multi-Pump Alternation Control
- Four (4) Relays + Isolated 4-20 mA Output Option
- Onboard USB & RS-485 Serial Communication Options
- Modbus[®] RTU Communication Protocol Standard
- Program the Meter from a PC with Onboard USB and MeterView[®] Pro
- UL & C-UL Approved

PRECISION DIGITAL CORPORATION

**PRECISION
DIGITAL**
www.predig.com

PD2-6001 Large Display Feet & Inches Process Meter

NEMA 4X, IP65
Rated Enclosure



UV Resistant
Sunlight Readable Display



INTRODUCTION

The Helios PD2-6001 is a multi-purpose, easy-to-use digital process meter featuring a bright, highly visible main display with convenient feet and inches designations. It is ideal for level applications requiring a comprehensible display, as it shows feet, inches, and fractions of an inch to the nearest sixteenth of an inch. It accepts current and voltage signals (e.g. 4-20 mA, 0-10 V). The analog input can be scaled to display the process in two different scales. The main display can indicate level in feet and inches with printed feet and inches designations, and the second display could be used to indicate some other scale, such as the volume in gallons or liters.

The basic model includes an isolated 24 VDC transmitter power supply that can be used to power the input transmitter or other devices. An additional isolated 24 VDC power supply is included with the 4-20 mA output option. A digital input is standard.

A fully loaded PD2-6001 meter has the following: four SPDT relays, 4-20 mA output, and two 24 VDC power supplies.

KEY FEATURES

Superluminous Sunlight Readable Display

PD2-6001's standard SunBright display features extraordinarily bright LEDs. It is perfect for applications where the meter is in direct sunlight or in applications where visibility may be impaired by smoke, fog, dust, or distance.

Precise, Accurate, and More Informative

The Helios' large 1.8" digits provides a highly accurate and precise view of the process measurement in feet & inches on the upper display, while the lower display provides a clearly identifiable custom tag. Its 24-bit A/D is accurate to $\pm 0.03\%$ of calibrated span ± 1 count. The PD2-6001's display also has lead zero blanking capability.

Function Keys

There are three function keys available to the user. These keys can be programmed to trigger certain events (i.e. acknowledge alarms, reset max and/or min, disable/enable output relays, or hold current relay states), provide direct menu access points, and more. The function keys are easily accessible behind the front panel door at the bottom of the meter. *See manual for location.*

Easy to Program

The user friendly dual-line display makes the PD2-6001 easy to set up & program with its programming buttons located behind the front door panel. There are three levels of password protection to help maintain the integrity of the programming and there are no jumpers to set for the meter input selection.

PD2-6001 Large Display Feet & Inches Process Meter

Free USB Programming Software

The Helios comes with free programming software that connects to your PC with a standard USB cable that is provided with each instrument. A new and very useful feature of this software is that it is resident on the Helios meter and installed directly into your PC. This eliminates the need to install drivers or download software from the internet. Just connect the Helios to your PC (the Helios even gets its power from the PC so you don't have to provide external power!) and within minutes you will be programming it with the free software.



Dual-Scale Display Feature

The Helios PD2-6001 has a rather unique, and very flexible dual-scale capability; a second scaled display can represent the measured input in a different form (i.e. feet & gallons). This is of particular value in level applications. Please see the examples shown below. Both displays are independently scaled and are based on the 4-20 mA input signal. This function can be used for feet & gallons, feet & meters, feet & percent, feet & barrels, and more.



Feet & Gallons



Feet & Meters



Feet & Percent



Feet & Barrels

Advanced Linearization Capability

The PD2-6001 includes a 32-point linearizer. In non-linear level applications (i.e. some pumping or lift stations), it can easily compensate for submerged equipment or plumbing that displace usable volume. A second independent 8-point linearizer is available for a second scaled display (PV2) when "level" function is enabled. Precision Digital's free MeterView Pro PC-based software greatly simplifies the construction of the linearization tables. The software can save this data to the meter and/or PC.

Advanced Linearization Capability

The PD2-6001 includes a 32-point linearizer. In non-linear level applications (i.e. some pumping or lift stations), it can easily compensate for submerged equipment or plumbing that displace usable volume. A second independent 8-point linearizer is available for a second scaled display (PV2) when "level" function is enabled. Precision Digital's free MeterView Pro PC-based software greatly simplifies the construction of the linearization tables. The software can save this data to the meter and/or PC.

Rounding

The rounding feature is used to give the user a steadier display with fluctuating signals. It causes the display to round to the nearest value according to the rounding value selected (1, 2, 5, 10, 20, 50, or 100). For example, with a rounding value of 10, and an input of 12346, the display would indicate 12350.

Max/Min Display

Max/Min (or Peak/Valley) is standard on the PD2-6001. Either display can be configured to show either maximum or minimum excursion since last reset. The displays can also be configured to toggle between Max and Min values. Both values can be simply reset from the front panel.

On-Board Digital Inputs and Outputs

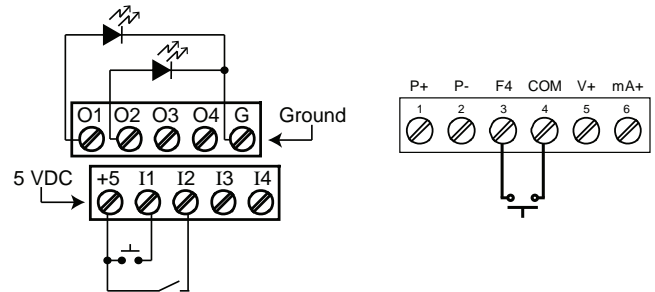

DIGITAL COMMUNICATIONS

Modbus® RTU Serial Communications

With onboard RS485 serial communication, the PD2-6001 can communicate with any Modbus *master* device using the popular Modbus communications protocol that is included in every Helios. This greatly increases the flexibility of the meter. Modbus provides much more capability than read PV and write set points. Below are some examples of other things that can be done with the meter's Modbus communications.

- Send a 6-character message to the lower display upon an event
- Convert a digital value to a 4-20 mA signal
- Remote user control (i.e. change set points, acknowledge alarms)
- Input a Modbus digital PV (in place of analog input)
- Remote override of any, or all, relays and analog outputs



Modbus PV Input



Remote Message

PD2-6001 Large Display Feet & Inches Process Meter

METERVIEW® PRO SOFTWARE

Configure, monitor, and datalog a PD2-6001 from a PC using Meter View Pro Software (available with each Helios meter via USB or for download at www.predig.com).

Monitor & Datalog

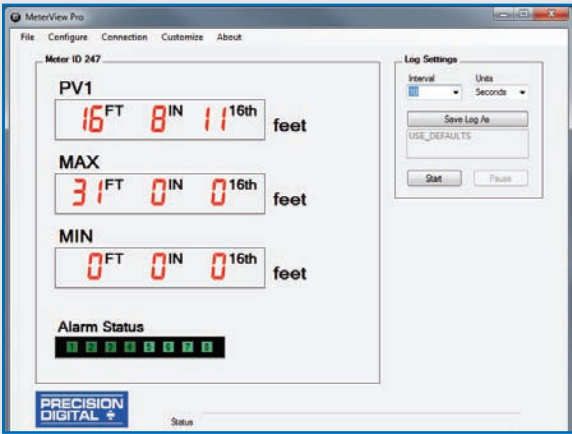

Linearization Feature

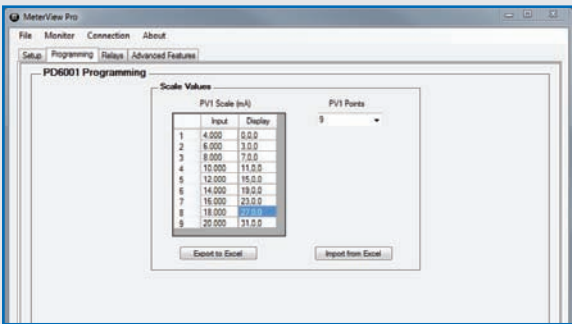

Setup

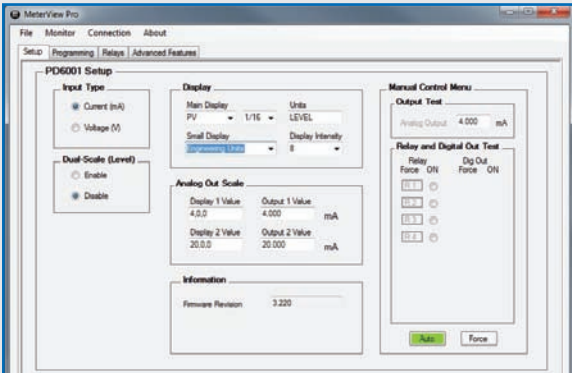

Relays

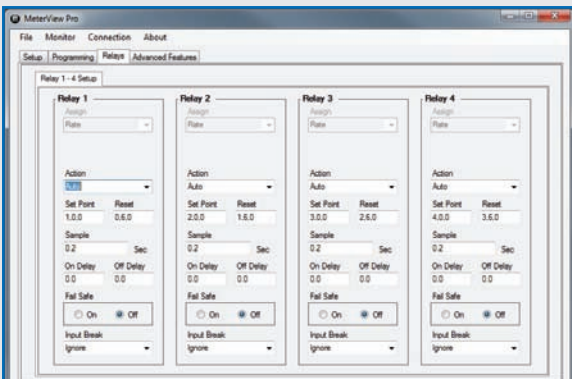

SIGNAL INPUT CONDITIONING

Non-linear input signals can be linearized with the Helios' simple to use round horizontal tank linearizer, or the Helios' powerful general purpose linearizer.

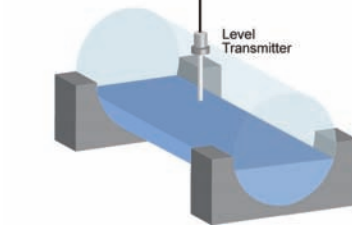
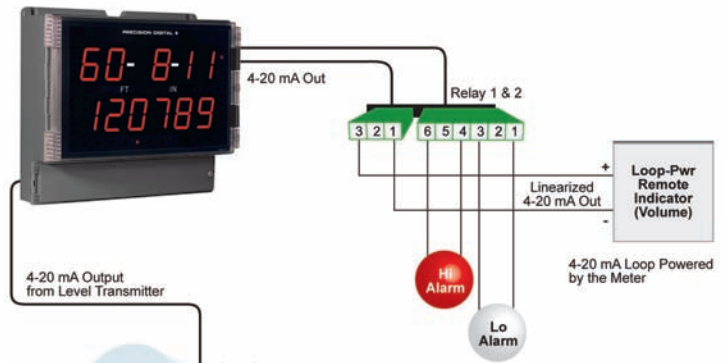
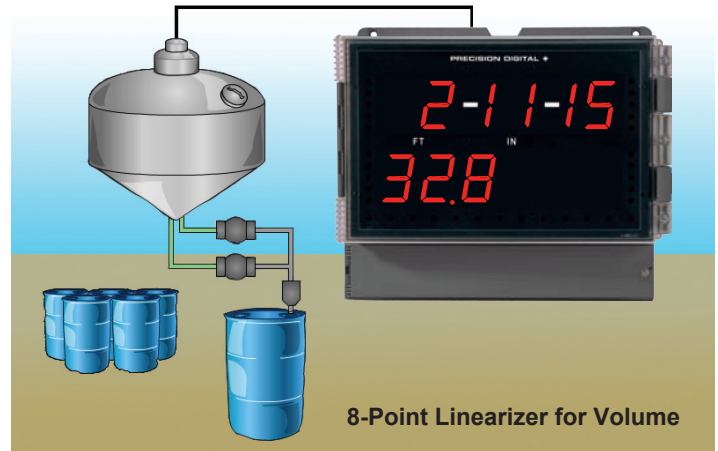

Round Horizontal Tank Signal Input Conditioner

MOUNTING OPTIONS

Pipe Mounting Kit

The meter can also be mounted to a pipe using the optional pipe mounting kit (PDA6260). This kit includes two mounting plates, two U-bolts, and the necessary nuts and bolts. See PD2-6001 manual for instructions.

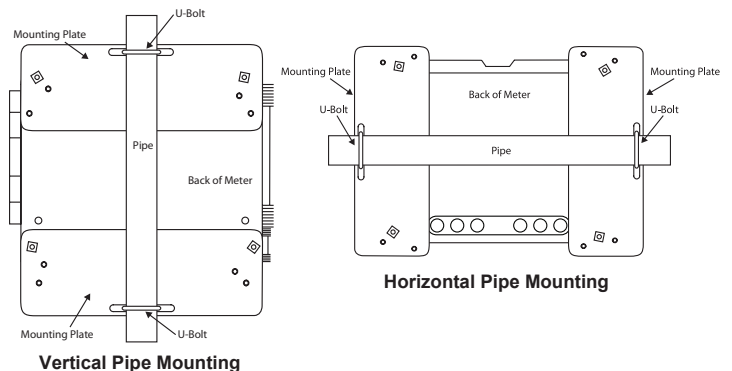

Wall Mounting

The meter can be mounted to any wall using the four provided mounting holes. Note that the bottom mounting holes are located behind the front door panel. See manual for instructions.

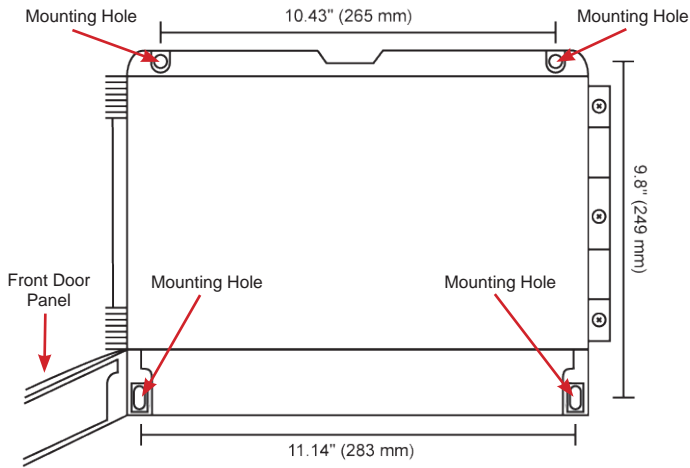

OUTPUTS

Relay Outputs

The PD2-6001 is available with four 3 A Form C relays (SPDT) with multiple power loss fail-safe options. Relays can be configured for proper protective action upon input loop break. Relay ON and OFF delay times are user adjustable. Up to four front panel indicators show alarm and/or relay state. All relays can be configured for 0-100% deadband.

Relay Operation/Configuration

There are powerful relay functions that can be configured in the Helios meter, including:

- Automatic reset only (non-latching)
- Automatic + manual reset at any time (non-latching)
- Latching (manual reset only)
- Latching with clear (manual reset only after alarm condition has cleared)
- Pump alternation control (automatic reset only)
- Sampling (activated for a user-specified time)
- User selectable fail-safe operation
- Relay action for loss (break) of 4-20 mA input signal
- Time delay (on and off), independent for each relay
- Manual control mode
- Interlock relay mode

Analog Output

The isolated analog retransmission signal can be configured to represent the process variable (PV), maximum (peak) value, minimum (valley) value, the value for any of the four relay set points, or Modbus input. While the output is nominally 4-20 mA, the signal will accurately accommodate under- and over-ranges from 1 to 23 mA.

Manual Output Control

Take control of any output with this feature. All relays can be forced ON or OFF, and the 4-20 mA output signal can be set to any value within its range. When the relays and 4-20 mA output are controlled manually, an LED labeled "M" is turned on and the associated Alarm LEDs (1-4) flash every 10 seconds indicating that the meter is in manual control mode.



Isolated Transmitter Power Supplies

A powerful 24 V @ 200 mA power supply is a standard feature on the Helios meter. It can be configured for 5, 10, or 24 V (default) by means of a simple internal jumper (see manual). An additional power supply (24 V @ 40 mA) is standard with the 4-20 mA output option.

Sampling Function (PV Triggered Timed Relay)

The sampling function allows the operator to set a set point for a "sampling" relay. When the PV reaches that set point, it will close that relay's contacts for a preset period of time (0.1 to 5999.9 seconds). An example of its use may be for beer/ale fermentation. When the batch reaches a certain pH, the relay contacts would close and by some means (light, horn, etc.) alert someone to take a sample, or provide the trigger to automatically take a sample of the batch. The utility of this function can, of course, be expanded beyond sampling and be used whenever a timed relay output closure is required when the PV reaches a certain set point.

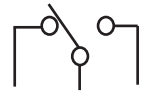

Interlock Relay(s)

This function allows a process to use one or more very low voltage input signals or simple switch contacts to control the state of one or more internal "interlock" relays. A violation (i.e. loss of input, open switch, or open circuit) forces one or more N/O interlock relay contacts to open. One input can be used in series with a number of interlock switches, or up to four inputs can be required to force-on one (or more) internal interlock relays. Please see *Safety Interlock on the ProVu Series* whitepaper on our website for more information.

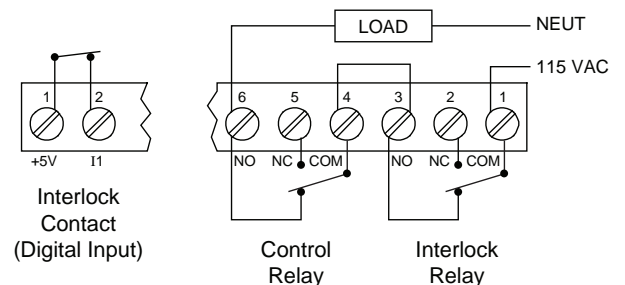

PD2-6001 Large Display Feet & Inches Process Meter

Multi-Pump Alternation

For pump control applications where 2 or more similar pumps are used to control the level of a tank or a well, it is desirable to have the pumps operate alternately; this prevents excessive wear and overheating of one pump over the lack of use of the others. The Helios can accommodate up to 8 pumps. In the example below, a pair of relays have been set up to alternate every time an on/off pump cycle is completed. Another pair of relays is used for low and high alarms.

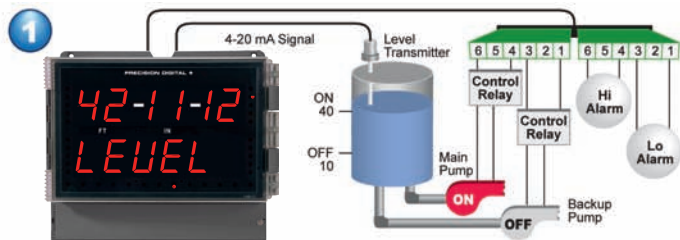

Relay #4 turns the main pump on at 40 feet and turns it off at 10 feet.

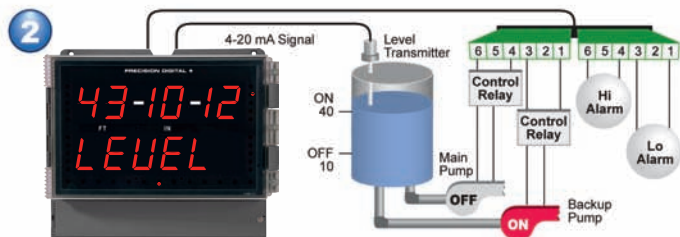

With the Pump Alternation feature activated, the next time the level reaches 40 feet, relay #3 transfers and starts the backup pump.

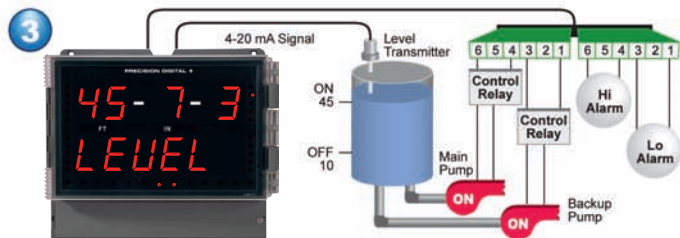

If the backup pump is not able to keep up, and the level reaches 45 feet, relay #4 transfers and starts the main pump as well.

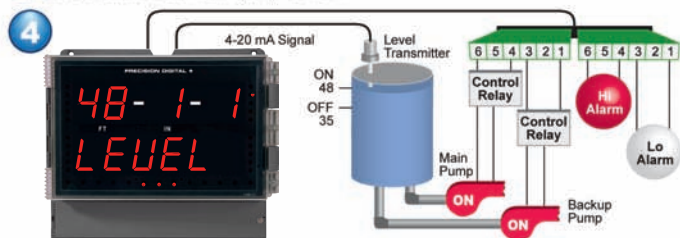

Relay #2 trips the High Level Alarm at 48 feet and resets at 35 feet.

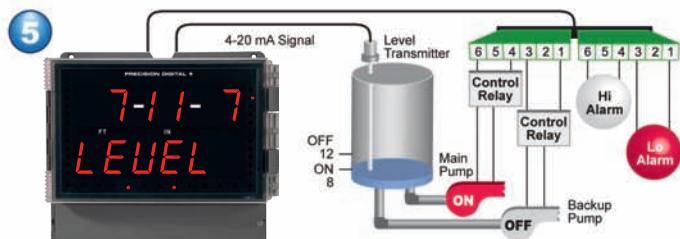

Relay #1 trips the Low Level Alarm at 8 feet and resets at 12 feet.

SPECIFICATIONS

Except where noted all specifications apply to operation at +25°C.

General

Display: Two lines with 1.8" (46 mm) high digits, red LEDs; 6 digits per line (-99999 to 999999), with lead zero blanking

Display Intensity: Eight user selectable intensity levels

Display Update Rate: 5/second (200 ms)

Overrange: Display flashes 999999

Underrange: Display flashes -999999

Display Assignment: Line 1 and line 2 may be assigned to PV1, PV2, PCT, d r-u, d gross, d nt-g, max/min, max & min, set points, units (line 2 only), or Modbus input.

Programming Methods: Four programming buttons, digital inputs, PC and MeterView Pro software, Modbus registers, or cloning using Copy function.

Noise Filter: Programmable from 2 to 199 (0 will disable filter)

Filter Bypass: Programmable from 0.1 to 99.9% of calibrated span

Recalibration: All ranges are calibrated at the factory. Recalibration is recommended at least every 12 months.

Max/Min Display: Max/min readings reached by the process are stored until reset by the user or until power to the meter is turned off.

Password: Three programmable passwords restrict modification of programmed settings.

Pass 1: Allows use of function keys and digital inputs

Pass 2: Allows use of function keys, digital inputs and editing set/reset points

Pass 3: Restricts all programming, function keys, and digital inputs.

Power Options: 85-265 VAC 50/60 Hz, 90-265 VDC, 20 W max or 12-24 VDC ± 10%, 15 W max

Powered over USB for configuration only.

Isolated Transmitter Power Supply: Terminals P+ & P-: 24 VDC ± 10%. 12-24 VDC powered models selectable for 24, 10, or 5 VDC supply (internal P+/P- switch).

85-265 VAC models rated @ 200 mA max, 12-24 VDC powered models rated @ 100 mA max, @ 50 mA max for 5 or 10 VDC supply.

Non-Volatile Memory: All programmed settings are stored in non-volatile memory for a minimum of ten years if power is lost.

Fuse: Required external fuse: UL Recognized, 5 A max, slow blow; up to 6 meters may share one 5 A fuse

Normal Mode Rejection: Greater than 60 dB at 50/60 Hz

Isolation: 4 kV input/output-to-power line; 500 V input-to-output or output-to-P+ supply

Overvoltage Category: Installation Overvoltage Category II: Local level with smaller transient overvoltages than Installation Overvoltage Category III.

Environmental: Operating temperature range: -40 to 65°C; Storage temperature range: -40 to 85°C; Relative humidity: 0 to 90% non-condensing

Connections: Removable and integrated screw terminal blocks accept 12 to 22 AWG wire.

Enclosure: UL Type 4X, IP65 rated. Polycarbonate & glass blended plastic case, color: gray. Includes four PG11 through-hole conduit openings, with two factory installed PG11, IP68, black nylon threaded hole plugs with backing nuts.

Wall Mounting: Four (4) mounting holes provided for screwing meter into wall.

Pipe Mounting: Optional pipe mounting kit (PDA6260) allows for pipe mounting.

Tightening Torque: Removable Screw Terminals: 5 lb-in (0.56 Nm); Digital I/O and RS485 Terminals: 2.2 lb-in (0.25 Nm)

Overall Dimensions: 10.63" x 12.59" x 4.77" (270 mm x 319.7 mm x 121.2 mm) (W x H x D)

Weight: 6.10 lbs (2.76 kg)

UL File Number: UL & C-UL Listed. E160849; 508 Industrial Control Equipment

Warranty: 3 years parts & labor

USB Connection: Compatibility: USB 2.0 Standard, Compliant Connector Type: Micro-B receptacle

Cable: USB A Male to Micro-B Cable

Driver: Windows 98/SE, ME, 2000, Server 2003/2008, XP 32/64-Bit, Vista 32/64-Bit, Windows 7 32/64-Bit, Windows 10 32/64-Bit

Power: USB Port

Process Input

Inputs: Field selectable: 0-20, 4-20 mA, ± 10 V (0-5, 1-5, 0-10 V), Modbus PV (slave)

Accuracy: $\pm 0.03\%$ of calibrated span ± 1 count, square root & programmable exponent accuracy; range: 10-100% of calibrated span

Temperature Drift: 0.005% of calibrated span/ $^{\circ}$ C max from 0 to 65 $^{\circ}$ C ambient, 0.01% of calibrated span/ $^{\circ}$ C max from -40 to 0 $^{\circ}$ C ambient

Signal Input Conditioning: Linear, square root, programmable exponent, or round horizontal tank volume calculation

Multi-Point Linearization: 2 to 32 points for PV or PV1; 2 to 8 points for PV2 (Dual-scale Level feature)

Programmable Exponent: 1.0001 to 2.9999

Round Horizontal Tank: Diameter & Length: 999.999 inch or cm calculates volume in gallons or liters respectively.

Low-Flow Cutoff: 0-999999 (0 disables cutoff function)

Decimal Point: Up to five decimal places or none: *d.ddddd*, *d.dddd*, *d.ddd*, *d.dd*, *d.d*, or *dddddd*

Calibration Range: 4-20 mA: minimum span input 1 & input 2: 0.15 mA. ± 10 V: minimum span input 1 & 2: 0.01 V. An Error message will appear if input 1 and input 2 signals are too close together.

Input Impedance: Voltage ranges: greater than 500 k Ω ; Current ranges: 50 - 100 Ω (depending on resettable fuse impedance)

Input Overload: Current input protected by resettable fuse, 30 VDC max. Fuse resets automatically after fault is removed.

F4 Digital Input Contacts: 3.3 VDC on contact. Connect normally open contacts across F4 to COM.

F4 Digital Input Logic Levels: Logic High: 3 to 5 VDC; Logic Low: 0 to 1.25 VDC

Relays

Rating: Four (4) SPDT (Form C) internal; rated 3 A @ 30 VDC and 125/250 VAC resistive load; 1/14 HP (≈ 50 W) @ 125/250 VAC for inductive loads

Noise Suppression: Noise suppression is recommended for each relay contact switching inductive loads; see page 18 for details.

Deadband: 0-100% of span, user programmable

High Or Low Alarm: User may program any alarm for high or low trip point. Unused alarm LEDs and relays may be disabled (turn off).

Relay Operation:

1. Automatic (non-latching) and/or manual reset
2. Latching (requires manual acknowledge) with/without clear
3. Pump alternation control (2 to 4 relays)
4. Sampling (based on time)
5. Off (disable unused relays and enable Interlock feature)
6. Manual on/off control mode

Relay Reset:

User selectable via buttons behind front panel or digital inputs

1. Automatic reset only (non-latching), when the input passes the reset point.
2. Automatic + manual reset at any time (non-latching)
3. Manual reset only, at any time (latching)
4. Manual reset only after alarm condition has cleared (latching)

Note: Button behind front panel or digital input may be assigned to acknowledge relays programmed for manual reset.

Time Delay: 0 to 999.9 seconds, on & off relay time delays;

Programmable and independent for each relay

Fail-Safe Operation: Programmable and independent for each relay.

Note: Relay coil is energized in non-alarm condition. In case of power failure, relay will go to alarm state.

Auto Initialization: When power is applied to the meter, relays will reflect the state of the input to the meter.

Isolated 4-20 mA Transmitter Output

Output Source: Process variable (PV), max, min, set points 1-4, Modbus input, or manual control mode

Scaling Range: 1.000 to 23.000 mA for any display range

Calibration: Factory calibrated: 4.000 to 20.000 = 4-20 mA output

Analog Output Programming: 23.000 mA maximum for all parameters: Overrange, underrange, max, min, and break

Accuracy: $\pm 0.1\%$ of span ± 0.004 mA

Temperature Drift: 0.4 μ A/ $^{\circ}$ C max from 0 to 65 $^{\circ}$ C ambient, 0.8 μ A/ $^{\circ}$ C max from -40 to 0 $^{\circ}$ C ambient.

Note: Analog output drift is separate from input drift.

Isolated Transmitter Power Supply: Terminals I+ & R: 24 VDC $\pm 10\%$. May be used to power the 4-20 mA output or other devices. All models rated @ 40 mA max.

External Loop Power Supply: 35 VDC maximum

Output Loop Resistance: For a 24 VDC power supply: 10 Ω minimum and 700 Ω maximum; for a 35 VDC power supply (external): 100 Ω minimum and 1200 Ω maximum.

Serial Communications

Protocol: Modbus[®] RTU

Meter Address/Slave ID: 1 - 247

Baud Rate: 300 - 19,200 bps

Transmit Time Delay: Programmable between 0 and 199 ms or transmitter always on for RS-422 communication

Data: 8 bit (1 start bit, 1 or 2 stop bits)

Parity: Even, odd, or none with 1 or 2 stop bits

Byte-to-Byte Timeout: 0.01 - 2.54 seconds

Turn Around Delay: Less than 2 ms (fixed)

Note: Refer to the Modbus Register Tables located at www.predig.com for details.

Digital Input & Output Terminal

Channels: 4 digital inputs & 4 digital outputs

Digital Input Logic High: 3 to 5 VDC

Digital Input Logic Low: 0 to 1.25 VDC

Digital Output Logic High: 3.1 to 3.3 VDC

Digital Output Logic Low: 0 to 0.4 VDC

Source Current: 10 mA maximum output current

Sink Current: 1.5 mA minimum input current

+5 V Terminal: To be used as pull-up for digital inputs only. Connect normally open push buttons across +5 V & DI 1-4.

WARNING! DO NOT use +5 V terminal to power external devices.



PD2-6001 Large Display Feet & Inches Process Meter

CONNECTIONS

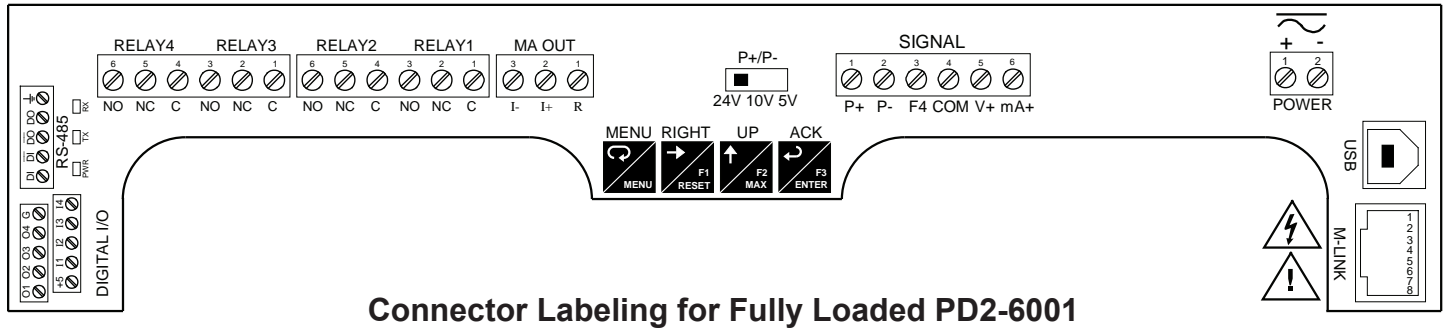

Connector Labeling for Fully Loaded PD2-6001

DIMENSIONS

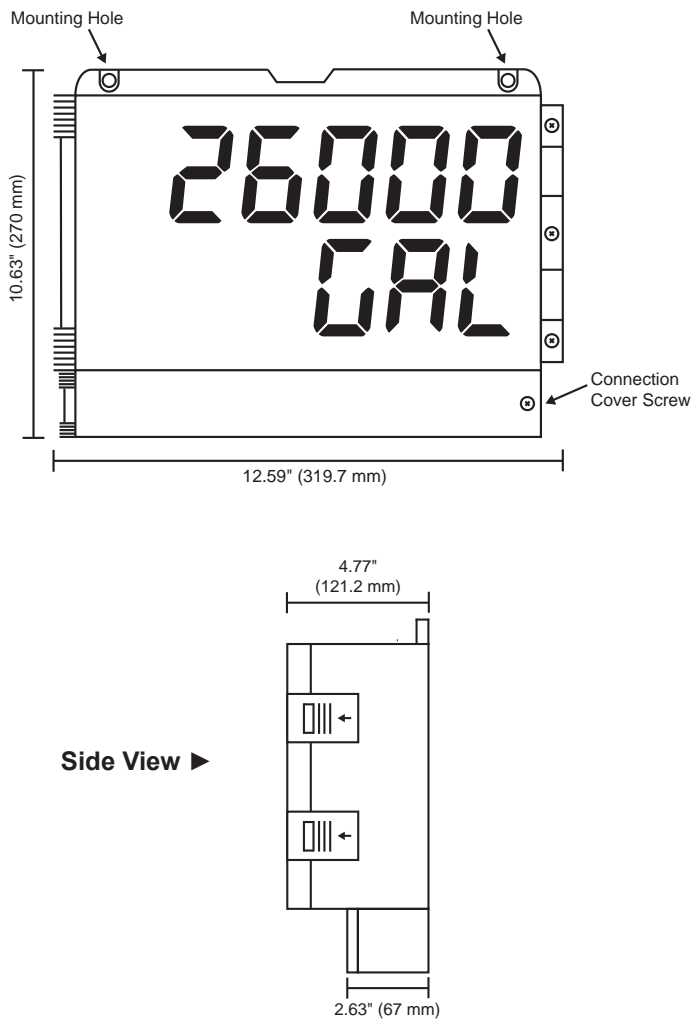

ORDERING INFORMATION

PD2-6001 • Standard Models		
85-265 VAC Model	12-24 VDC Model	Options Installed
PD2-6001-6H0	PD2-6001-7H0	No Options
PD2-6001-6H7	PD2-6001-7H7	4 Relays & 4-20 mA Output

Note: 24 V Transmitter power supply standard on all models.

Accessories	
Model	Description
PDA6260	Pipe Mounting Kit
PDA7485-I	RS-232 to RS-422/485 Isolated Converter
PDA7485-N	RS-232 to RS-422/485 Non-Isolated Converter
PDA8485-I	USB to RS-422/485 Isolated Converter
PDA8485-N	USB to RS-422/485 Non-Isolated Converter
PDAPLUG2	Plastic Conduit Plug
PDX6901	Suppressor (snubber): 0.01 μ F/470 Ω , 250 VAC

Your Local Distributor is:

Disclaimer

The information contained in this document is subject to change without notice. Precision Digital Corporation makes no representations or warranties with respect to the contents hereof, and specifically disclaims any implied warranties of merchantability or fitness for a particular purpose. ©2016-2017 Precision Digital Corporation. All rights reserved.