



IP Enabled Solutions

Next Generation Enterprise Communications





Did you know? **Facts**

An existing Voice over IP (VoIP) system can be enhanced and also provide entire building and emergency notifications; it can even send communication between buildings. Learn how our technologies expand VoIP endpoint functionality offering more communication methods than desk phones alone can provide.





IP Endpoint with Speaker



IP Endpoint with Display



IP-to-Analog Gateways



IP Enabled Paging Servers

Hardware Solutions

“Our VoIP investment was maximized by eliminating the need for a separate audio infrastructure.”

“Now, we have one solution to optimize messaging and emergency evacuation for our entire organization.”

AtlasIED provides innovative IP-based solutions for commercial building spaces needing:



Wide Area Coverage



High Output Sound Levels



Visual Notifications



Hands Free Communication



Weather & Vandal Resistance

Our system takes full advantage of existing Voice and Data networks while preserving the convenience and user-friendliness of VoIP phones to now cover important areas - that a VoIP handset alone cannot.



Products available on the Cisco Global Price List or through certified AtlasIED Solutions Partners

Auto Provisioning



Auto-Provisioning eliminates the need to manually configure new endpoints or individually apply firmware updates in the environment.

SRST Support



Our devices support Cisco's Unified Survivable Remote Site Telephony (SRST). SRST provides remote location call-processing redundancy when access to the centralized Cisco CUCM is interrupted because of a WAN outage.

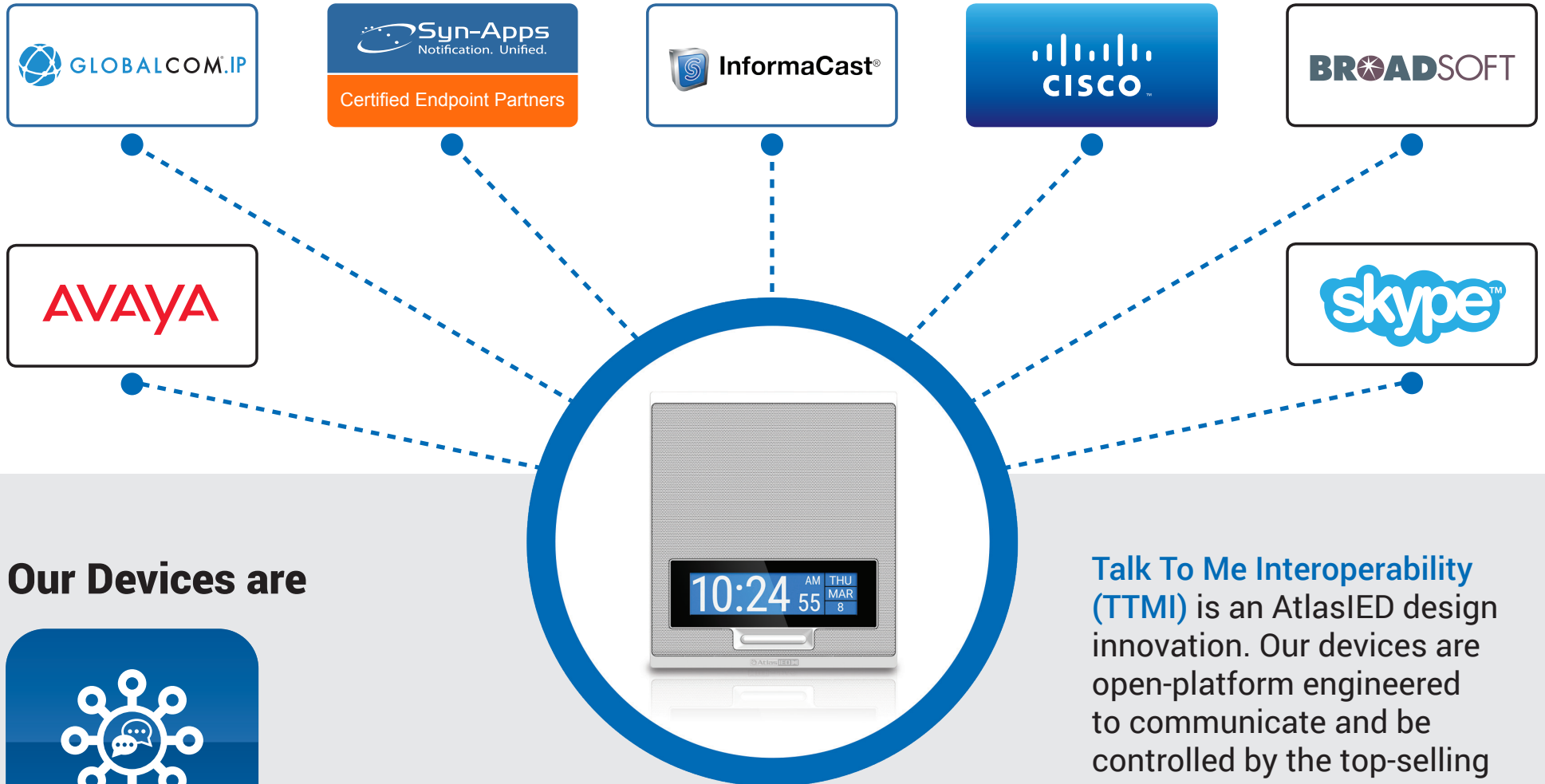

Our Devices are



Talk To Me Interoperability (TTMI) is an AtlasIED design innovation. Our devices are open-platform engineered to communicate and be controlled by the top-selling providers of unified communications, notification software platforms, and standard SIP / PBX systems.

One solution that talks to all.



Connect More Speakers with our

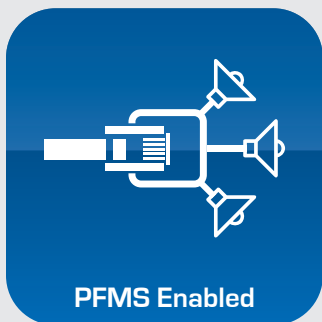

Connection Port

An AtlasIED amplification breakthrough technology. Now, you can power additional passive speakers from our PoE device.

Power For Multiple Speakers (PFMS) connection port can provide amplifier power when used on a PoE+ or PoE network switch. **PFMS** is provided in our IP enabled speakers, visual displays, and IP-to-Analog Gateways.

More Power - Now Available

IP Enabled Speakers - Features and Benefits

Easy Installation

- Requires Only One Network Cable
- Power Over Ethernet
- Can Be Powered by Power Supply When PoE is Not Available
- Simple Mounting

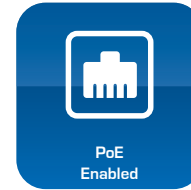
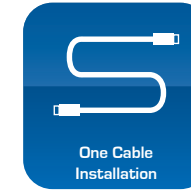

Plug and Play

- Auto Registers with 3rd Party Applications
- Auto Provisions to Simplify Configuration and Installation



Onboard Amplifier and Processor

- Class D Amp Technology
- Ultra-Energy Efficient
- Designed to Support 44k Audio
- Amplifier has a PFMS Port to Power More Speakers

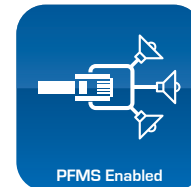
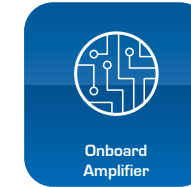

Accurate and High-Output Performance

- Engineered for Excellent Speech Intelligibility
- Optimized for Crystal Clear Talkback
- High-Output Sound Levels for Large Areas



Local Input / Output and Control Ports

- Input a Local Audio Source such as Music or Paging
- Output Audio to External Devices
- Trigger Pre-Recorded Announcements or Critical Alerts
- Relay to Interface with External Devices

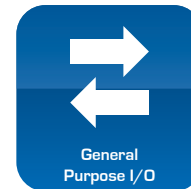
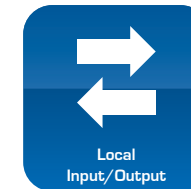

Interoperable with Multiple Media Stream Protocols

- Supports VoIP G.711 Codec
- Supports VoIP G.722 Codec



Surface / Flush Mount Speaker with Display Solutions

AtlasIED IP-SDMF endpoint includes high-output speaker, visual display, talkback mic, and flasher in one solution.

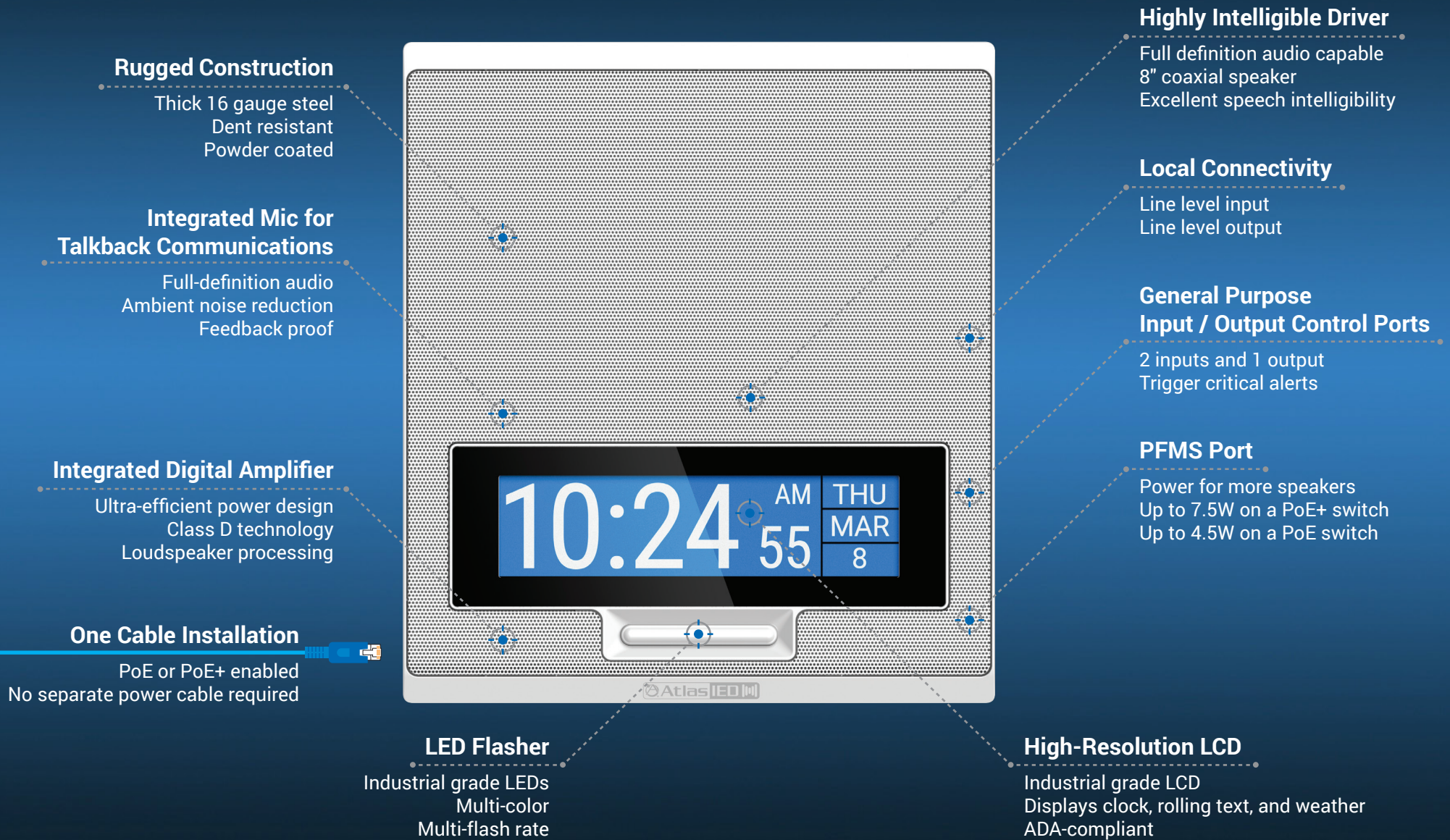

Surface / Flush Mount Speaker Solution

AtlasIED IP-SM IP endpoint includes high-output speaker and talkback mic.

Rugged Construction

- Thick 16 gauge steel
- Dent resistant
- Powder coated

Integrated Mic for Talkback Communications

- Full-definition audio
- Ambient noise reduction
- Feedback proof

Integrated Digital Amplifier

- Ultra-efficient power design
- Class D technology
- Loudspeaker processing

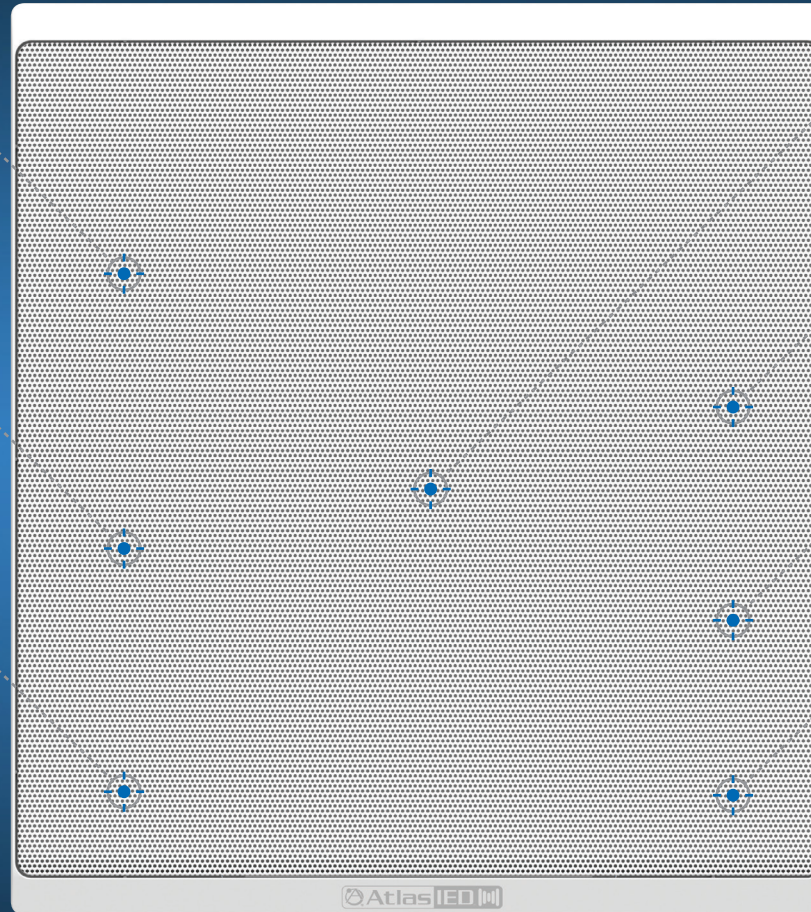

Highly Intelligent Driver

- Full definition audio capable
- 8" coaxial speaker
- Excellent speech intelligibility

Local Connectivity

- Line level input
- Line level output

General Purpose Input / Output Control Ports

- 2 inputs and 1 output
- Trigger critical alerts

PFMS Port

- Power for more speakers
- Up to 7.5W on a PoE+ switch
- Up to 4.5W on a PoE switch



One Cable Installation

- PoE or PoE+ enabled
- No separate power cable required

Drop-Tile Speaker Solution

AtlasIED IP-22SYSMF IP endpoint includes high-output speaker, talkback mic, and flasher in easy to install solution.

Lay In Drop-Tile Design

- 2' x 2' design
- Easily lays into ceiling grids
- Dent resistant
- Powder coated

Integrated Mic for Talkback Communications

- Full-definition audio
- Ambient noise reduction
- Feedback proof

Integrated Digital Amplifier

- Ultra-efficient power design
- Class D technology
- Loudspeaker processing

PFMS Port

- Power for more speakers

One Cable Installation

- PoE or PoE+ enabled
- No separate power cable required

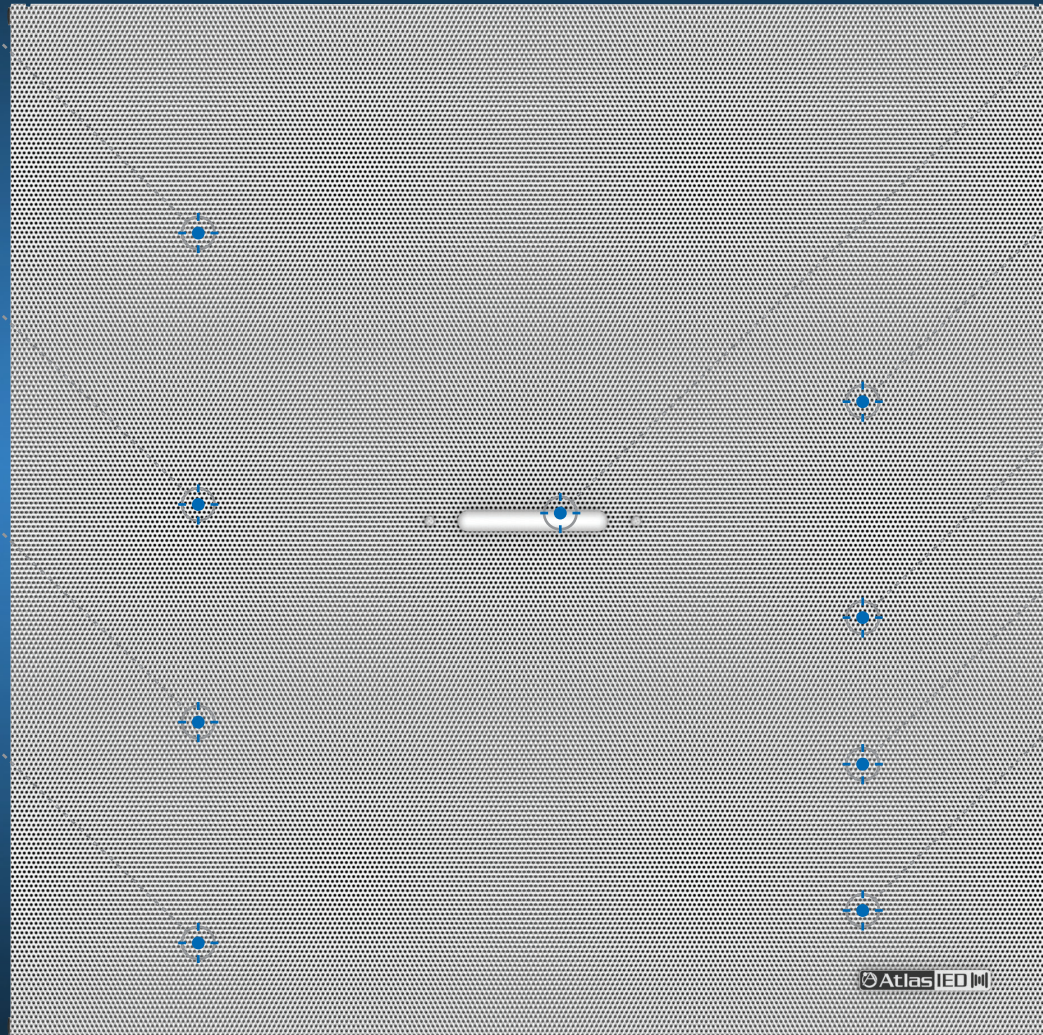

LED Flasher

- Industrial grade LEDs
- Multi-color
- Multi-flash rate

Highly Intelligent Driver

- Full definition audio capable
- 8" coaxial speaker
- Excellent speech intelligibility

General Purpose Input / Output Control Ports

- 2 inputs and 1 output
- Trigger critical alerts

Local Connectivity

- Line level input
- Line level output

Includes Assembled Enclosure

AtlasIED

Vandal Proof Speaker Solution

AtlasIED IP-HVP IP endpoint includes high-output speaker and talkback mic with a vandal proof design.

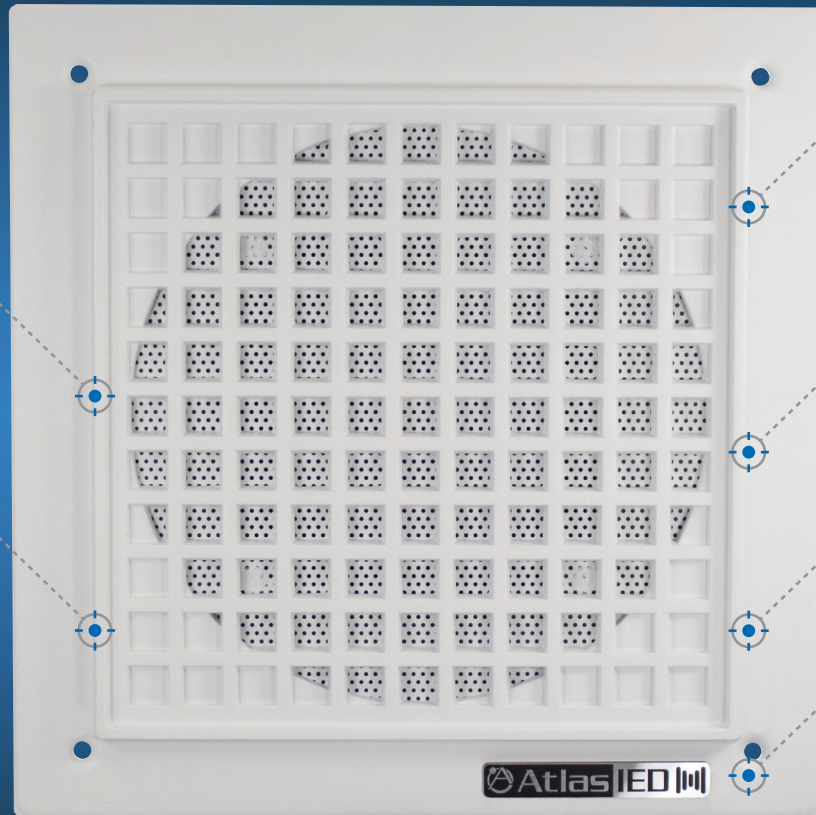

Integrated Digital Amplifier

- Ultra-efficient power design
- Class D technology
- Loudspeaker processing

PFMS Port

Power for more speakers

High Output Driver

- Full definition audio capable
- Horn speaker design
- Excellent speech intelligibility

General Purpose Input / Output Control Ports

- 2 inputs and 1 output
- Trigger critical alerts

Vandal Proof Enclosure

- All-weather design

Local Connectivity

- Line level input
- Line level output

One Cable Installation

- PoE or PoE+ enabled
- No separate power cable required

Full Line of Products

Indoor Wall IP Endpoint with Speaker, LCD, and Flasher

- Included Talkback Microphone
- Surface or Flush Mount Sold Separately



IP-SDMF

Indoor Wall IP Endpoint with Speaker and LCD

- Included Talkback Microphone
- Versions with Loudspeaker Transducer or Horn Assembly
- Surface or Flush Mount Sold Separately



IP-SDM



IP-SDH

Indoor Drop Tile Ceiling Mount IP Endpoint with Speaker

- Included Talkback Microphone
- Available With or Without LED Flasher
- Pre-Assembled Unit Reduces Installation Time

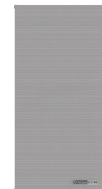

IP-12SYSM



IP-12SYSMF



IP-22SYSM

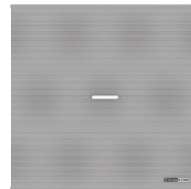

IP-22SYSMF

Indoor Wall / Ceiling Mount IP Endpoint with Speaker

- Included Talkback Microphone
- Surface or Flush Mount Enclosures Sold Separately
- Ceiling Mount Capability via I8S-TB or I8S-TBE Tile Bridge Package



IP-SM

Weather & Vandal Resistant Indoor / Outdoor IP Endpoint with Speaker

- IP34 Rated
- High-Output Horn Assembly
- Surface or Flush Mount Sold Separately



IP-HVP

Outdoor Use Intercom Station

- SIP Compatible Only (Does Not Support InformaCast or SynApps)
- Pedestal Mount Capable



IPS-VOI

Indoor Wall IP
Endpoint with Speaker,
LCD, and Flasher

Indoor Wall IP
Endpoint with Speaker
and LCD

Indoor Wall IP
Endpoint with Speaker,
Flasher and LED Display

Specialty Models

- 25V/70V Transformer and Switch for Retrofit Applications
- Included Talkback Microphone
- Surface or Flush Mount Sold Separately

- 25V/70V Transformer and Switch for Retrofit Applications
- Included Talkback Microphone
- Surface or Flush Mount Sold Separately

- Included Talkback Microphone
- Surface or Flush Mount Sold Separately



IP-SDMF-72



IP-SDM-72



IP-SDMFLED

The IP-SDMF-72 and IP-SDM-72 can be installed connecting both 25V/70V speaker wire to an analog headend and network cable to a switch simultaneously.

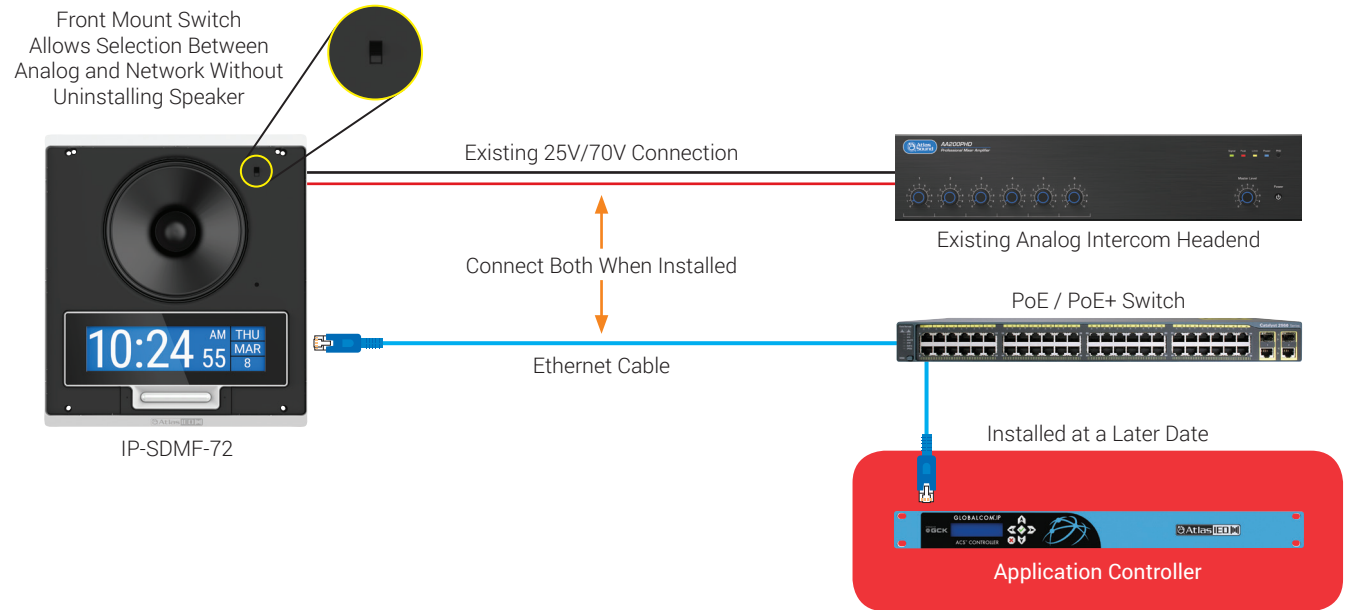

IP-to-Analog Gateway

AtlasIED IP-ZCM is perfect for connecting your unified communication platform to analog audio systems.

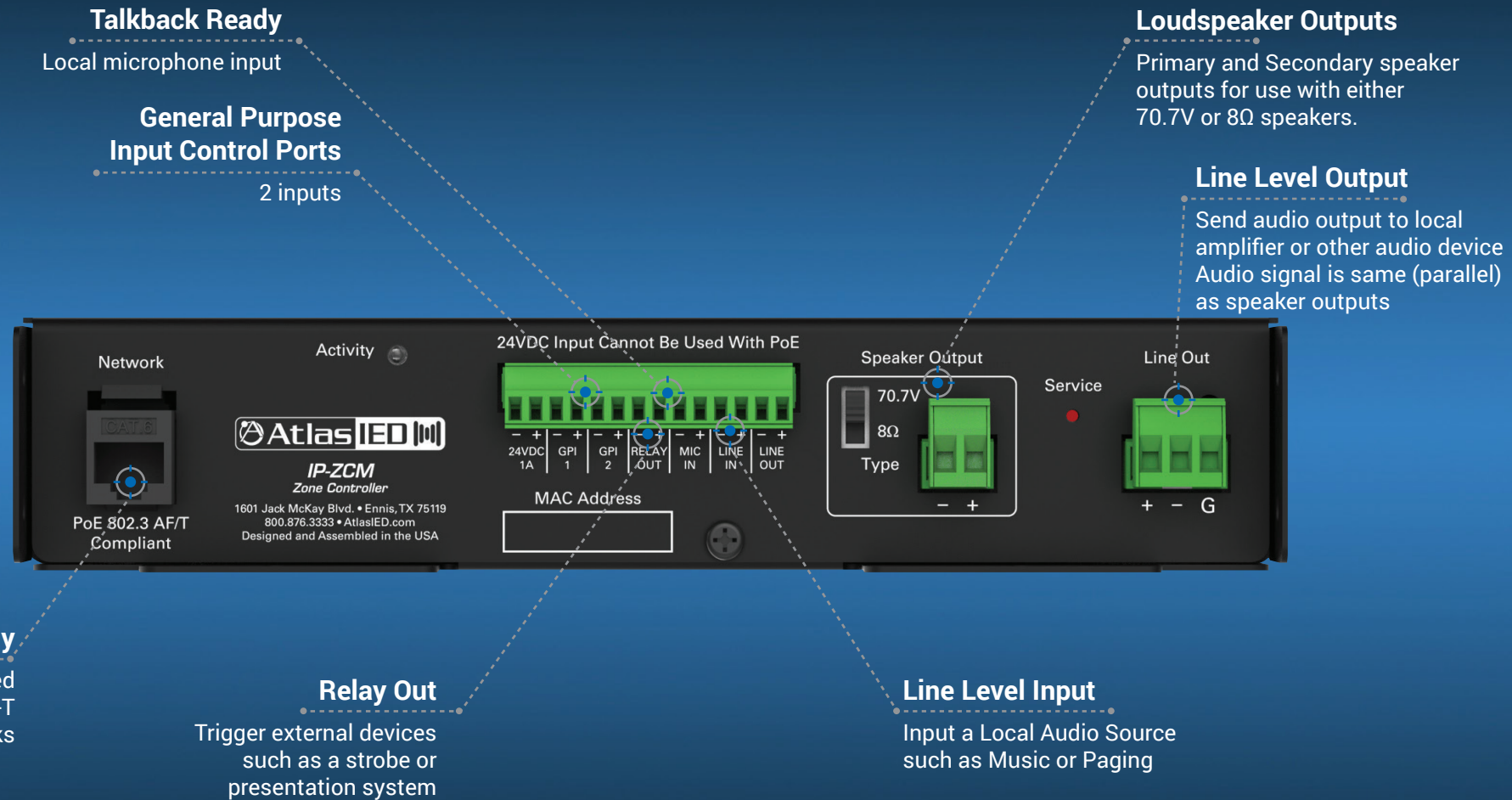

IP-to-Analog Gateway

AtlasIED IP-ZCM System Example

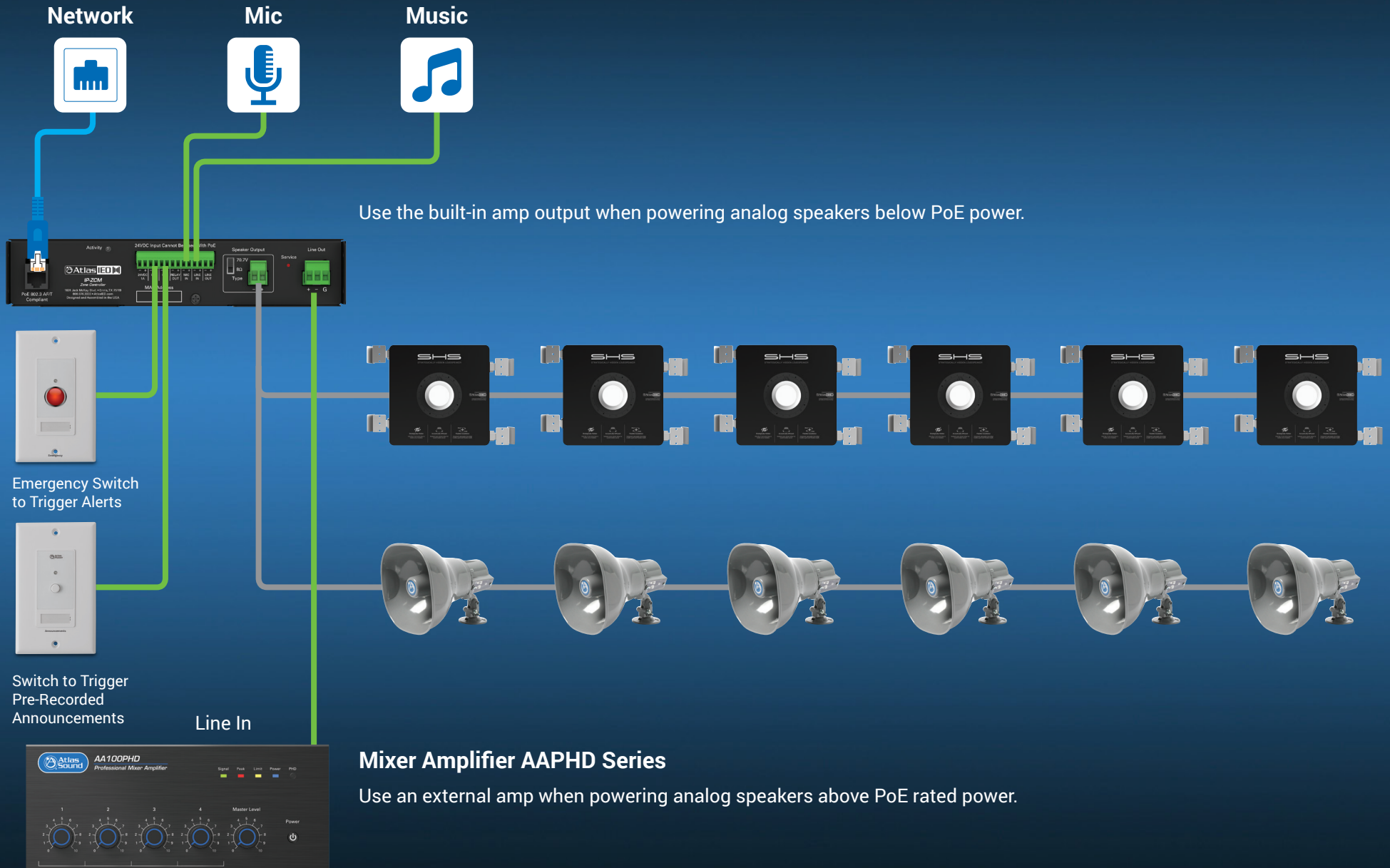

IP-to-Analog Gateways - Features and Benefits

Easy Installation

- Requires Only One Network Cable
- Power Over Ethernet
- Can Be Powered by Power Supply When PoE is Not Available
- Simple Mounting

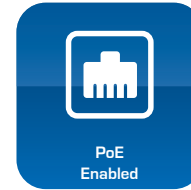

Plug and Play

- Auto Registers with 3rd Party Applications
- Auto Provisions to Simplify Configuration and Installation



Onboard Amplifier

- Class D Amp Technology
- Ultra-Energy Efficient
- Designed to Support 44k Audio
- Amplifier Has PFMS Port to Power Additional Speakers

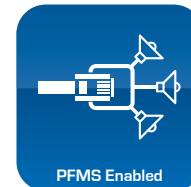
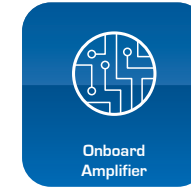

Accurate and High-Output Performance

- Engineered for Excellent Speech Intelligibility
- Optimized for Crystal Clear Talkback



Local Input / Output and Control Ports

- Input a Local Mic and Level Source
- Output Audio to External Devices
- Trigger Pre-Recorded Announcements or Critical Alerts
- Relay to Interface with External Devices

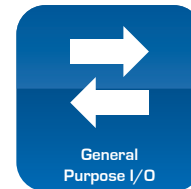
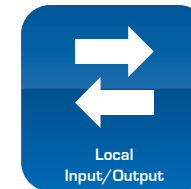

Interoperable with Multiple Media Stream Protocols

- Supports VoIP G.711 Codec
- Supports VoIP G.722 Codec



Full Line of Products

Network Specifications

- Dynamic or Static IP Address
- IEEE 802.3 10/100Base-T Ethernet
- IEEE 802.1q Tagging
- IEEE 802.11AT Compliant
- VoIP Standard Audio: G.711 u-law/a-law (16 kbit/s) or G.722 Wideband Audio (64 kbit/s)

Audio Features

- Integrated Amplifier
- Aux Audio Line-In Unbalanced (2.8Vpp 10K)
- Aux Audio Line-Out Unbalanced (2.8Vpp 10K)

Additional Features

- Phone / Night Loud Ringer
- External Power Supply Option



IP-ZCM

Technical Specifications

Single Device Rack Mount Kit Package IP-to-Analog Gateway

- Includes One IP-ZCM Unit
- Includes 1 RU Rack Kit



IP-ZCM1RMK

Dual Device Rack Mount Kit Package IP-to-Analog Gateway

- Includes Two IP-ZCM Units
- Includes 1 RU Rack Kit



IP-ZCM2RMK

Dual-Sided Visual Display Solution

AtlasIED IP-DDS extends notifications with effective visual text alerts for high ambient noise areas or large spaces.

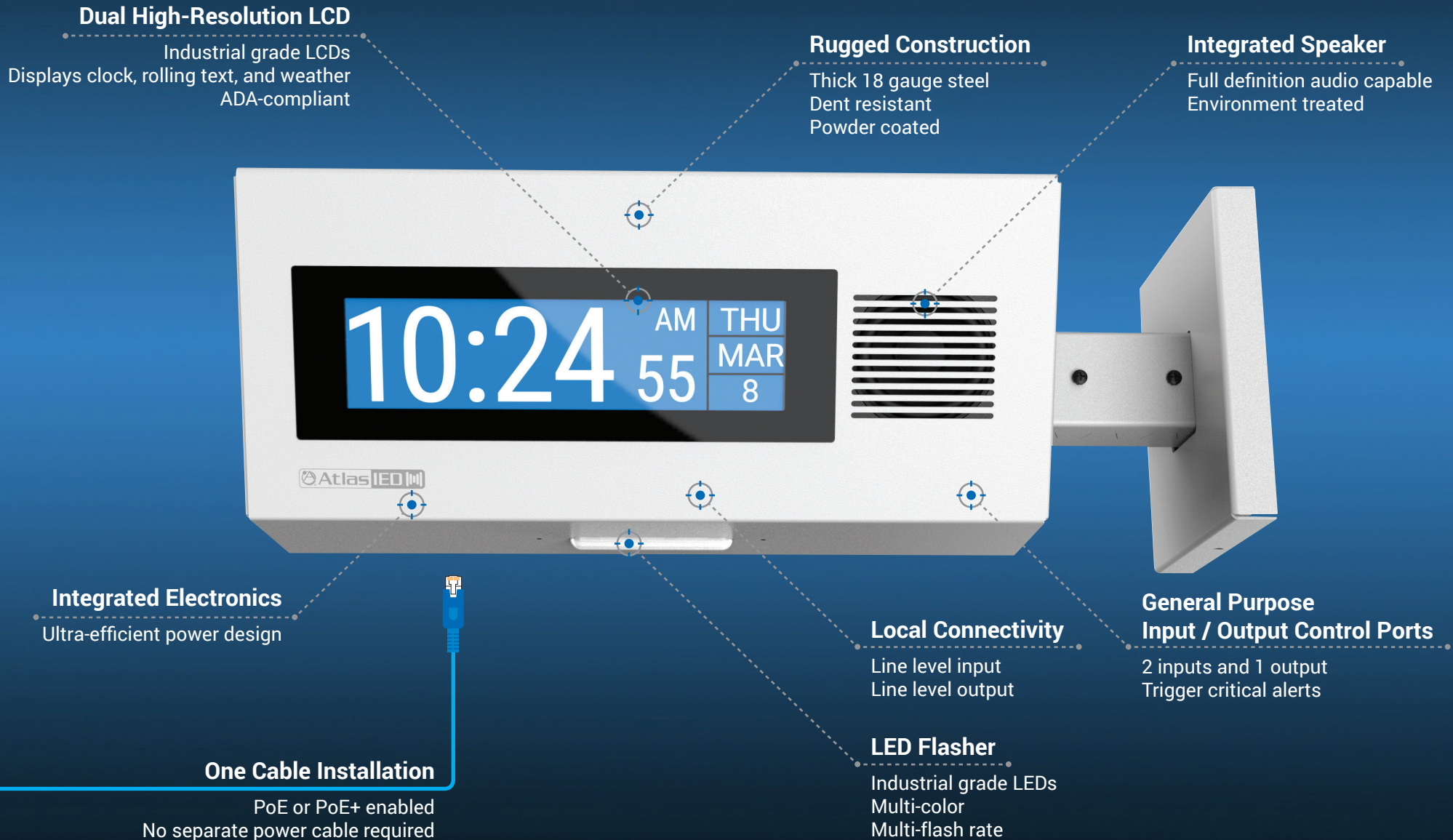

Single-Sided Visual Display Solution

AtlasIED IP-DM extends notifications with effective visual text alerts for high ambient noise areas or large spaces.



IP Enabled Visual Displays - Features and Benefits

Easy Installation

- Requires Only One Network Cable
- Power Over Ethernet+
- Can Be Powered by Power Supply When PoE+ is Not Available
- Simple Mounting

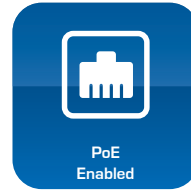
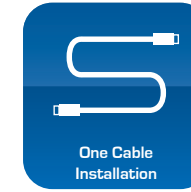

Plug and Play

- Auto Registers with 3rd Party Applications
- Auto Provisions to Simplify Configuration and Installation



ADA Compliant

- Meets Requirements for Visual Critical Alerts
- Visually Reinforce the Audio Communication System



Displays

- Time
- Weather
- Visual Messages
- Emergency Messages



Onboard Amplifier

- Amplifier has a PFMS Port to Power More Speakers
- Class D Amp Technology
- Ultra-Energy Efficient
- Designed to Support 44k Audio

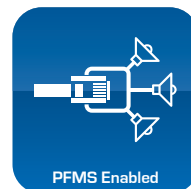
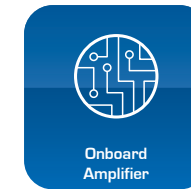

Local Input / Output and Control Ports

- Input a Local Audio Source such as Music
- Output Audio to External Devices
- Trigger Pre-Recorded Announcements or Critical Alerts
- Relay to Interface with External Devices

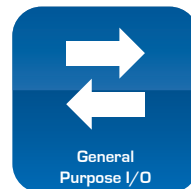
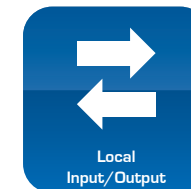

Full Line of Products

Dual Sided LCD with Speakers and Flasher

- Dual High Resolution LCD
- Integrated Amplifier Output
- Dual 3" Speakers
- Multi-Color Flasher



IP-DDS*

Dual Sided LCD with Flasher

- Dual High Resolution LCD
- Integrated Amplifier Output
- Can Power External Speakers
- Multi-Color Flasher



IP-DD*

Single Sided LCD

- Single High Resolution LCD
- Integrated Amplifier Output
- Can Power External Speakers
- Integrated Microphone



IP-DM

Surface Mount Strobe Assembly

- SIP Activation
- 5 User Blink Scenes Available
- Event Controlled Relay
- Mailbox Message Waiting Indication



IPS-SIS

* Note: IP-DD and IP-DDS must be run off PoE+ enabled switch.

SIP-to-Analog Gateway

AtlasIED IPS-ZC4 is a SIP-only gateway that allows VoIP devices to effectively communicate to any analog audio system.



SIP Paging Server

AtlasIED IPS-VPS is the perfect for creating group paging through multicast transmission to SIP endpoints and analog systems. In applications where the SIP servers and VoIP communications managers may not support paging groups or where 3rd party notification applications are not required.



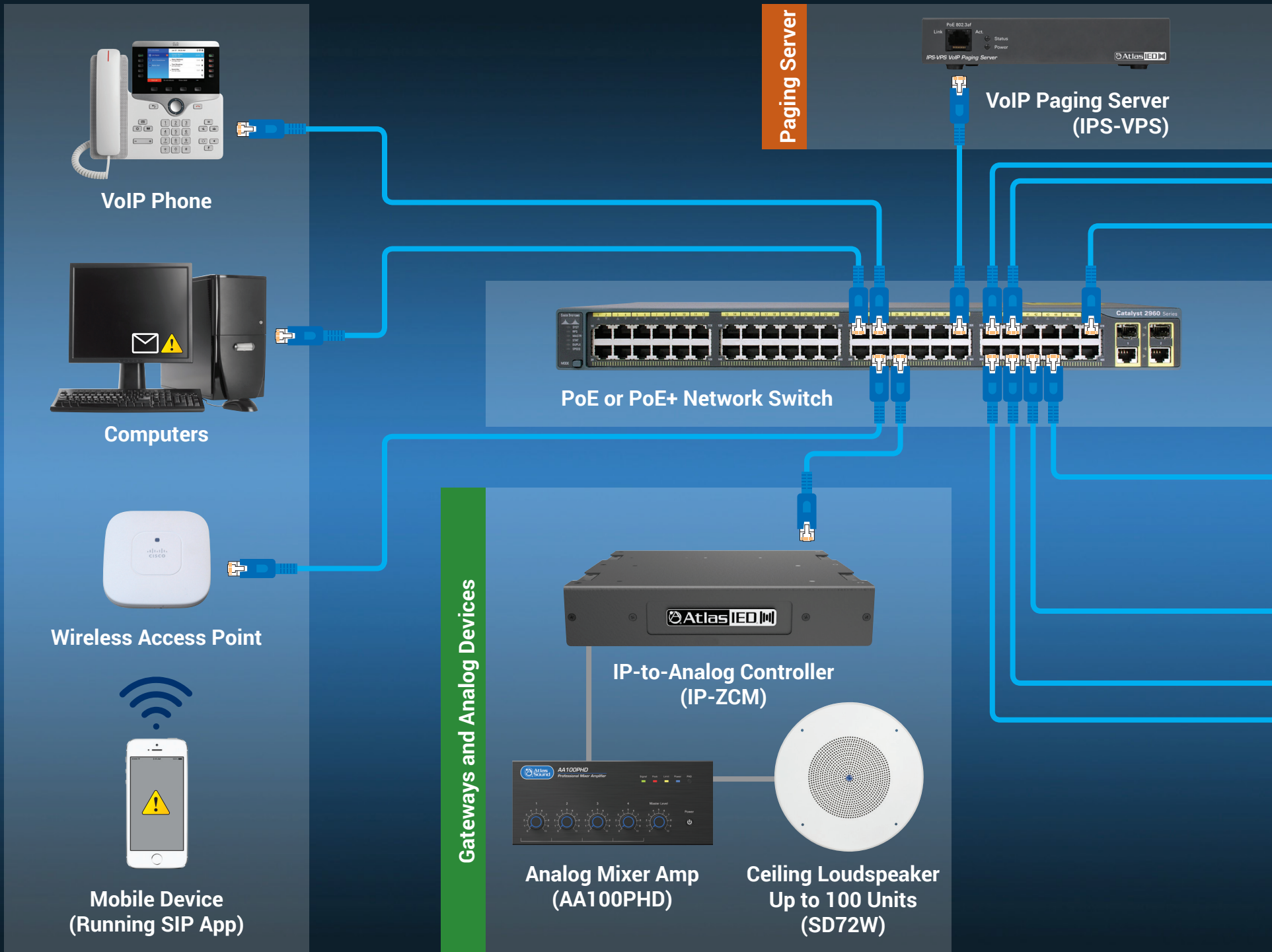

Paging Server

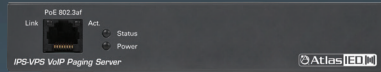

VoIP Paging Server (IPS-VPS)

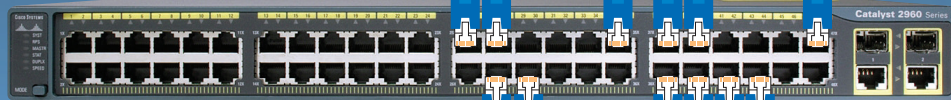

PoE or PoE+ Network Switch



IP-to-Analog Controller (IP-ZCM)



Analog Mixer Amp (AA100PHD)

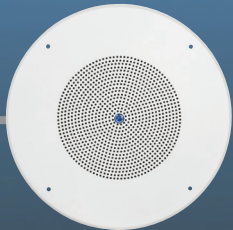

Ceiling Loudspeaker Up to 100 Units (SD72W)

Gateways and Analog Devices

VoIP Phone

Computers

Wireless Access Point

Mobile Device (Running SIP App)

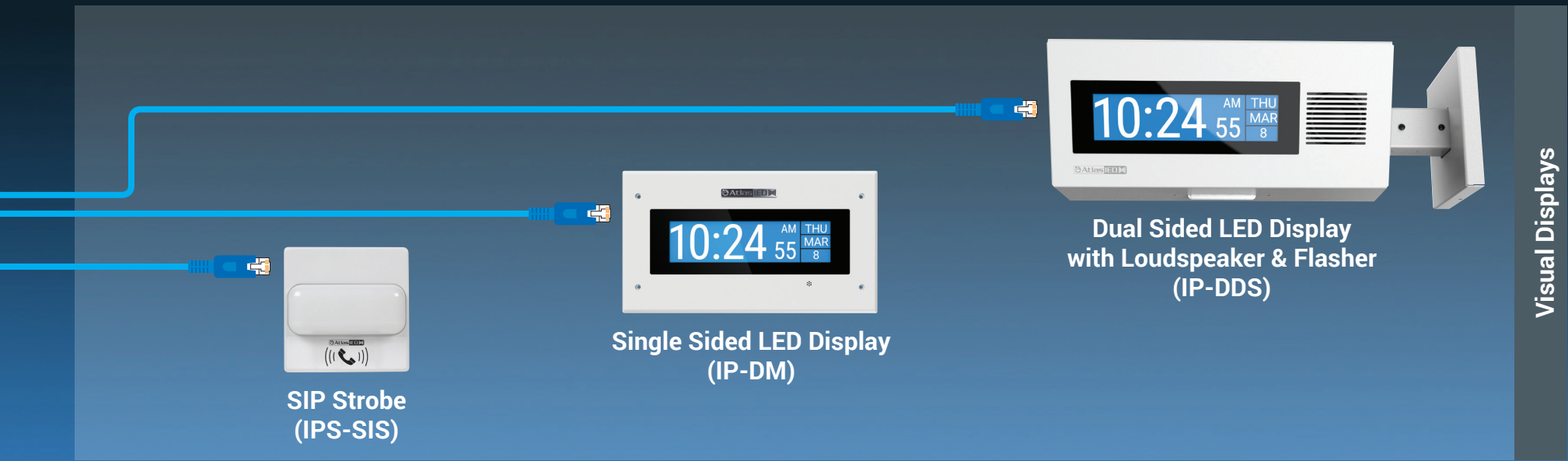

Visual Displays

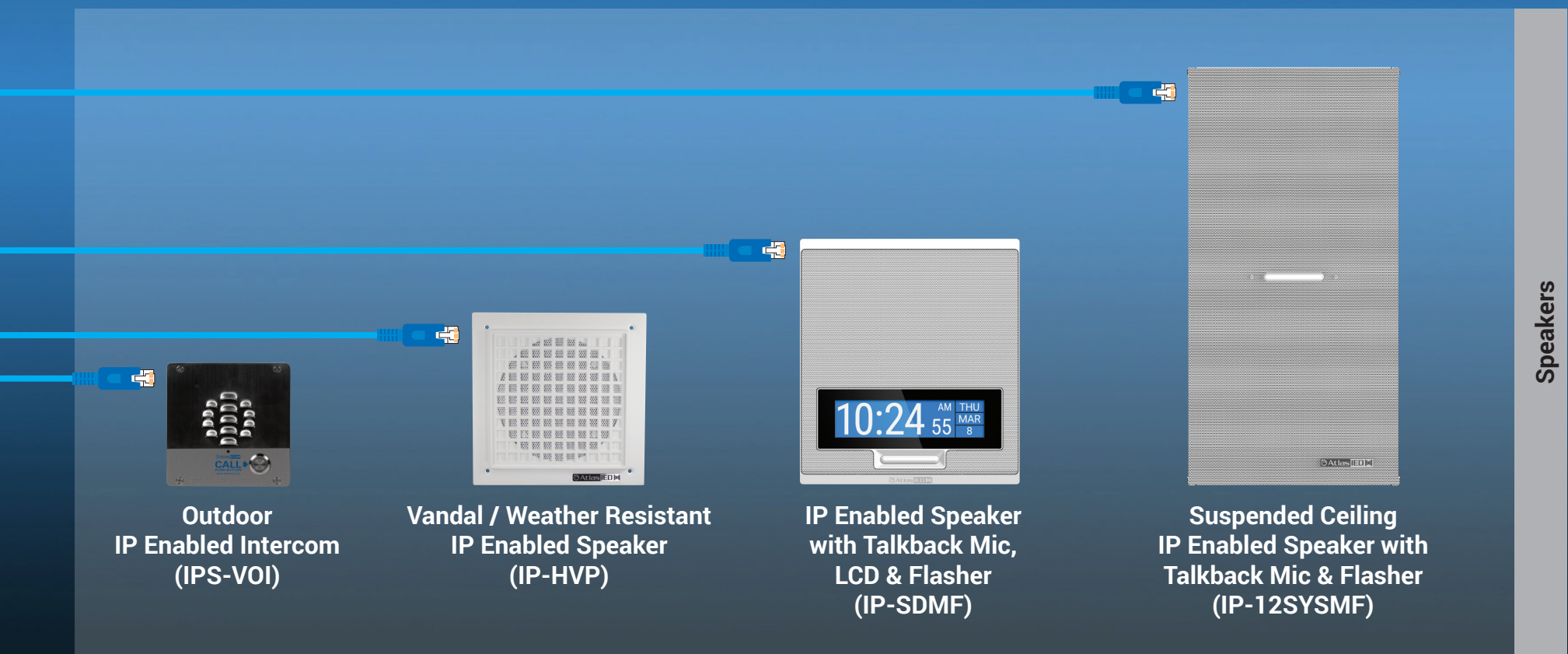

Speakers

We are a Global Company with Locations Around the World



AtlasIED is a global electronics manufacturer providing comprehensive audio solutions for commercial businesses. We save organizations time and money with the effective use of audio communication systems, while also helping to maintain a safe work environment. This is accomplished with our industry-leading mass notification, life safety, VoIP and speech privacy systems. Our technologies seamlessly interface and integrate into existing and future analog and IT-based infrastructures.

Our systems are used by the largest enterprise businesses such as Fortune 1000 companies, schools, universities, manufacturing plants, airports, public transportation hubs, sports arenas, hospitals, hotels, and large retail chain stores. We also work in smaller businesses like your local coffee shop, bar, restaurant, and house of worship.

**At AtlasIED, we care about every business size, and we want each of them to not only survive -
*we want them to thrive!***

The AtlasIED Advantage

These are the four main motivations why customers choose us over other commercial audio manufacturers.



AtlasIED stays at the forefront of commercial building construction trends. Our products are built future proof. Our innovative solutions focus on everyday use cases and cut down installation times, reduce maintenance requirements, increase productivity, and provide long-lasting reliability.

AtlasIED has products that have been installed over 20 years ago, and are still working as if they were brand new.



AtlasIED provides over 2,000 unique product offerings. We are very proud to offer a specific system solution for your exact need like no one else.

You don't have to rely on multiple suppliers to complete your entire project. You can get it from AtlasIED as your one source provider.



We make it easy for you to choose the right solution with our industry leading support teams. We have over 44 dedicated sales managers, vertical market managers, and technology specialists located in each of the major geographic areas. These professionals are trained to help identify your needs and provide the right system solution. We also deliver a deeper layer of support with our 120+ manufacturer representatives and distributors located around the world.



Even though AtlasIED is a multi-million dollar manufacturing organization with nine locations, we are a family-owned business and still manufacture within the United States carrying an ISO9001:2008 Quality Standards Certification. Our company makes quicker decisions and nimble enough to accommodate market trend changes. We retain our people and maintain work stability that results in high-quality standards for our products.

Need Assistance Choosing the Right System?

AtlasIED support specialists provide design assistance to ensure you make the correct system decision.

Contact Us Today



(800) 876-3333



atlasied.com



support@atlasied.com



facebook.com/atlasied



AtlasIED channel