

# IRWIN®

## Wood Drilling















[www.irwin.com](http://www.irwin.com)

## A Century of Quality and Innovation

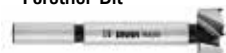
In 1885 the IRWIN® Auger Bit Company was formed. Over 125 years later, IRWIN is still a leading manufacturer of wood drilling bits and accessories. No matter what wood drilling product you face, IRWIN Tools makes a drill bit that performs the job. Our mark of quality is stamped right on the shank of our full range of bits. Whether the job requires quick, clean holes or precise finish work, IRWIN has a bit for every application and every need.

Use the chart below to determine which bit is best for the job at hand.

Bit Style	Size Range	Typical Trades	Application Benefits
 <p>Tri-Flute Bit</p>	7/16" to 1-1/2" diameter	Carpentry, Electrical, Plumbing	Fast, clean holes with reduced "break out" when through-hole drilling. Full-screw tip requires less effort.
 <p>Spade Bit</p>	1/4" to 1-1/2" diameter 4-3/4" to 16" lengths	Carpentry, Electrical, Plumbing	Fast, clean holes with reduced "break out" for through-hole drilling or countersinking.
 <p>Solid Center Auger Bit</p>	1/4" to 1-1/2" diameter 7-1/2" length	Carpentry, Electrical, Plumbing	Self-feeding tip pulls bit into the work for repetitive cutting of fast, clean holes with a clean exit hole. Single-spur cutting edge scribes the circumference of the hole for a smooth finish.
 <p>Hollow Center Auger Bit</p>	3/8" to 2" diameter 7-1/2" to 29" lengths	Public Utilities, Electrical, Plumbing, Carpentry, Log Homes	Hollow center provides better chip removal for deeper holes in utility poles and logs.
 <p>Installer Bit</p>	1/4" to 3/4" diameter 12" to 36" lengths	Telecommunications, Cable/Internet, Security Systems	Wire hole near the end of the bit enables user to pull wire back through the hole after drilling.
 <p>Hex Bolt Bit</p>	3/8", 1/2", 5/8" diameter	Deck Building, Carpentry	2 in 1 design drills both the through hole and countersink for hex bolt and washer installation.
 <p>Self-Feed Bit</p>	1" to 4-5/8" diameter	Plumbing, Electrical, General Contracting	Replaceable self-feeding tip pulls bit into the wood. Best for cutting larger holes with clean edges.
 <p>Flex Installers</p>	1/4"-1-1/4" diameters 24"-72" lengths	Electrical, Plumbing	Hole in flute for easy wire pulling through walls, ceilings, and floors. Tapered flute for fast chip ejection and smooth drilling.
 <p>Forstner Bit</p>	1/4" to 2-1/8" diameter	Fine Woodworking, Cabinet Making	Precise cutting of smooth, flat-bottomed (blind) pocket holes with clean, sharp edges.
 <p>Brad Point Bit</p>	1/8" to 1/2" diameter	Woodworking, Cabinet Making	Precise cutting of smooth through-holes with clean, sharp edges and reduced "break out."
 <p>Countersink Bit</p>	1/8" to 1/2" diameter	Woodworking, Cabinet Making	Perfect for variable-size countersink holes.
 <p>Plug Cutters</p>	1/8" to 1/2" diameter	Woodworking, Cabinet Making	Perfect for cutting dowels or plug holes.
 <p>Quick-Change Extensions</p>	1/4" available in 2", 6" and 12" length 3/8" available in 2", 5-1/2" and 12" length 7/16" available in 5-1/2", 12" and 18" length	Woodworking, Cabinet Making	Lock-n-Load® system for quick release and fast bit changes.

## SPEEDBOR MAX SPEED BIT FEATURES

1. Three cutting spurs for fast, clean holes, less breakout, and long drilling life
2. Full screw-point tip allows bit to self-feed for ease of drilling
3. Tapered tri-flute design for fast chip ejection and less binding
4. 1/4" quick-change shank reduces slipping in standard chucks and is compatible with all 1/4" quick-change chucks, including impact drills (3/8" for 1-3/8" and 1-1/2" bits)

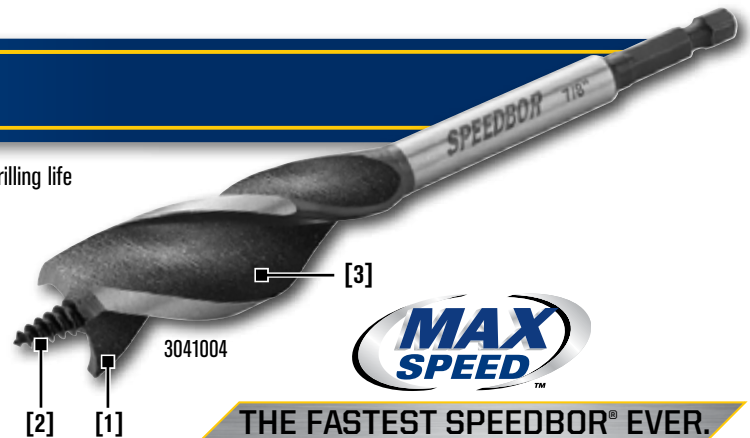

THE FASTEST SPEEDBOR® EVER.

### 6" Standard Length Bits

- Ideal for holes up to 4" deep.



3041004

Diameter	Length	Flute Length	Shank Size	Bulk Item #	Clam Item #
7/16"	6"	1-3/4"	1/4" Quick-Change	3041015B	3041015
1/2"	6"	1-3/4"	1/4" Quick-Change	3041001B	3041001
9/16"	6"	1-7/8"	1/4" Quick-Change	3041014B	3041014
5/8"	6"	2"	1/4" Quick-Change	3041002B	3041002
11/16"	6"	2-1/4"	1/4" Quick-Change	3041016B	3041016
3/4"	6"	2-3/8"	1/4" Quick-Change	3041004B	3041004
13/16"	6"	2-1/2"	1/4" Quick-Change	3041017B	3041017
7/8"	6"	2-5/8"	1/4" Quick-Change	3041005B	3041005
15/16"	6"	2-3/4"	1/4" Quick-Change	3041018B	3041018
1"	6"	2-3/4"	1/4" Quick-Change	3041007B	3041007
1-1/8"	6"	2-7/8"	1/4" Quick-Change	3041019B	3041019
1-1/4"	6"	2-7/8"	1/4" Quick-Change	3041009B	3041009
1-3/8"	6"	2-7/8"	3/8" Quick-Change	3041020B	3041020
1-1/2"	6"	2-7/8"	3/8" Quick-Change	3041021B	3041021

#### Sets

3-Piece Set (5/8", 3/4", 1")	3041003
6-Piece Set (1/2", 5/8", 3/4", 7/8", 1", 1-1/4", Pro-Set Case)	3041006
10-Piece Set (7/16", 1/2", 9/16", 5/8", 3/4", 7/8", 1", 1-1/8", 1-1/4", 1-3/8", Storage Wallet)	1801022

### 4" Short Length Bits

- Shorter overall length for drilling in tight spaces. Ideal for holes up to 2" deep.



1866035

Diameter	Length	Flute Length	Shank Size	Clam Item #
1/2"	4"	1-1/2"	1/4" Quick-Change	1866033
5/8"	4"	1-1/2"	1/4" Quick-Change	1866034
3/4"	4"	1-1/2"	1/4" Quick-Change	1866035
7/8"	4"	1-1/2"	1/4" Quick-Change	1866036
1"	4"	1-1/2"	1/4" Quick-Change	1866037
1-1/8"	4"	1-1/2"	1/4" Quick-Change	1866038
1-1/4"	4"	1-1/2"	1/4" Quick-Change	1866039

#### Sets

3-Piece Set (5/8", 3/4", 1")	1877241
5-Piece Set (1/2", 5/8", 3/4", 7/8", 1")	1877240
6-Piece Set (1/2", 5/8", 3/4", 7/8", 1", 1-1/8")	1877239
6-Piece Set (1/2", 5/8", 3/4", 7/8", 1", 6" Quick-Change Extension)	1877242



3041003



3041006



1877239

### 12", 16" and 24" Long Length Bits

- Hole in flute for easy wire pulling through walls, ceilings, and floors.
- Ideal for holes up to 4" deep.



Wire Pulling

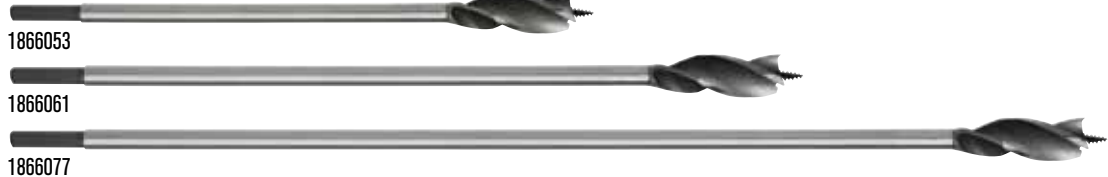

1866053

1866061

1866077

Diameter	Length	Flute Length	Shank Size	Clam Item #
1/2"	12"	1-3/4"	3/8" Hex	1866040
5/8"	12"	2"	3/8" Hex	1866051
3/4"	12"	2-3/8"	3/8" Hex	1866052
7/8"	12"	2-5/8"	3/8" Hex	1866053
1"	12"	2-3/4"	3/8" Hex	1866054
1-1/8"	12"	2-7/8"	7/16" Hex	1866055
1-1/4"	12"	2-7/8"	7/16" Hex	1866056
1-3/8"	12"	2-7/8"	7/16" Hex	1866057

Diameter	Length	Flute Length	Shank Size	Clam Item #
1/2"	16"	1-3/4"	3/8" Hex	1866058
5/8"	16"	2"	3/8" Hex	1866059
3/4"	16"	2-3/8"	3/8" Hex	1866060
7/8"	16"	2-5/8"	3/8" Hex	1866061
1"	16"	2-3/4"	3/8" Hex	1866062
1-1/8"	16"	2-7/8"	7/16" Hex	1866063
1-1/4"	16"	2-7/8"	7/16" Hex	1866064
1-3/8"	16"	2-7/8"	7/16" Hex	1866065

Diameter	Length	Flute Length	Shank Size	Tubed Item #
1/2"	24"	1-3/4"	3/8" Hex	1866074
5/8"	24"	2"	3/8" Hex	1866075
3/4"	24"	2-3/8"	3/8" Hex	1866076
7/8"	24"	2-5/8"	3/8" Hex	1866077
1"	24"	2-3/4"	3/8" Hex	1866078
1-1/8"	24"	2-7/8"	7/16" Hex	1866079
1-1/4"	24"	2-7/8"	7/16" Hex	1866080
1-3/8"	24"	2-7/8"	7/16" Hex	1866081

### SPEEDBOR® Spade Bits

#### SPEEDBOR SPADE BIT FEATURES

1. Unique point and cutting edge for fast chip removal and overall drilling speed.
2. Double cutting spurs scribe the outside of the hole for reduced breakout and clean holes.
3. 40% thicker cutting edge and enlarged shank for increased strength and long drilling life.\*
4. 1/4" quick-change shank reduces slipping in standard chucks and is compatible with all 1/4" quick-change chucks, including impact drills.



\*versus previous IRWIN spade bits



87912

#### 4-3/4" SPEEDBOR Short Length Spade Bits

- For drilling in tight spaces



88812

#### 6" SPEEDBOR Standard Length Spade Bits

Diameter	Length	Shank Size	Item #
1/2"	4"	1/4" Quick-Change	87908
5/8"	4"	1/4" Quick-Change	87910
3/4"	4"	1/4" Quick-Change	87912
7/8"	4"	1/4" Quick-Change	87914
1"	4"	1/4" Quick-Change	87916
1-1/4"	4"	1/4" Quick-Change	87920
1-1/2"	4"	1/4" Quick-Change	87924

Diameter	Length	Shank Size	Item #	Bulk Item #
1/4"	6"	1/4" Quick-Change	88804	99904
5/16"	6"	1/4" Quick-Change	88805	99905
3/8"	6"	1/4" Quick-Change	88806	99906
7/16"	6"	1/4" Quick-Change	88807	99907
1/2"	6"	1/4" Quick-Change	88808	99908
9/16"	6"	1/4" Quick-Change	88809	99909
5/8"	6"	1/4" Quick-Change	88810	99910
11/16"	6"	1/4" Quick-Change	88811	99911
3/4"	6"	1/4" Quick-Change	88812	99912
13/16"	6"	1/4" Quick-Change	88813	99913
7/8"	6"	1/4" Quick-Change	88814	99914
15/16"	6"	1/4" Quick-Change	88815	99915
1"	6"	1/4" Quick-Change	88816	99916
1-1/8"	6"	1/4" Quick-Change	88818	99918
1-1/4"	6"	1/4" Quick-Change	88820	99920
1-3/8"	6"	1/4" Quick-Change	88822	99922
1-1/2"	6"	1/4" Quick-Change	88824	99924



88712

#### 16" SPEEDBOR Extra-Long Spade Bits

- For extended reach
- Not for use with bit extensions or drill presses.

Diameter	Length	Shank Size	Item #	Bulk Item #
3/8"	16"	1/4" Hex	88706	99706
1/2"	16"	1/4" Hex	88708	99708
5/8"	16"	1/4" Hex	88710	—
3/4"	16"	1/4" Hex	88712	99712
7/8"	16"	1/4" Hex	88714	99714
1"	16"	1/4" Hex	88716	99716

## SPEEDBOR® Spade Bit Sets



88885



1764344

## SPEEDBOR Spade Bit Pro Set



341008

- Sliding latch design provides added security.



4935704



88702

## Standard Spurless Spade Bits



88012BULK

Diameter	Length	Shank Size	Bulk Item
3/8"	6"	1/4" Hex	88006BULK
1/2"	6"	1/4" Hex	88008BULK
5/8"	6"	1/4" Hex	88010BULK
3/4"	6"	1/4" Hex	88012BULK
7/8"	6"	1/4" Hex	88014BULK
1"	6"	1/4" Hex	88016BULK
1-1/8"	6"	1/4" Hex	88018BULK
1-1/4"	6"	1/4" Hex	88020BULK
1-1/2"	6"	1/4" Hex	88024BULK

## European Hinge Bits



IW14334

Diameter	Length	Shank Size	Bulk Item
26 mm	4"	1/4" Round	IW14334
35 mm	4"	1/4" Round	IW14335

Description	Diameter	Item #
-------------	----------	--------

### Short Length Spade Bit Sets

3-pc set	1/2", 3/4", 1"	87950 87954
6-pc Pro Set w/Extension	3/4", 7/8", 15/16", 1", 1-1/8" Short Length Bits; 6" OAL Quick-Change Extension	1768411

### Standard Length Spade Bit Sets

3-pc Set	1/2", 3/4", 1"	88889
4-pc Set w/Extension	1/2", 3/4", 1", & 6" Quick-Change Extension	4935687
5-pc Set	3/8", 1/2", 5/8", 3/4", 1"	88885
6-pc Set	3/8", 1/2", 5/8", 3/4", 7/8", 1"	88886
6-pc Set w/Workshop Rack	3/8", 1/2", 5/8", 3/4", 7/8", 1" & Rack	88888
6-pc Set w/Extension	3/8", 1/2", 5/8", 3/4", 1" & 6" Quick-Change Extension	88898
8-pc Pro Set Case	3/8", 1/2", 5/8", 7/8", 1", 1-1/8", 1-1/2" & Pro Set Case	341008
10-pc SPEEDBOR Pro Set	3/8" x 6", 1/2" x 6", 5/8" x 6", 3/4" x 6", 7/8" x 6", 1" x 6", 1-1/8" x 6", 1-1/4" x 6", 1-3/8" x 6", 1-1/2" x 6"	1890204
13-pc Set	1/4", 5/16", 3/8", 7/16", 1/2", 9/16", 5/8", 11/16", 3/4", 13/16", 7/8", 15/16", 1"	88894
13-pc Set w/Workshop Rack	1/4", 5/16", 3/8", 7/16", 1/2", 9/16", 5/8", 11/16", 3/4", 13/16", 7/8", 15/16", 1"	88887
17-pc Set	1/4", 5/16", 3/8", 7/16", 1/2", 9/16", 5/8", 11/16", 3/4", 13/16", 7/8", 15/16", 1", 1-1/8", 1-1/4", 1-3/8", 1-1/2"	1792761
17-pc Set	3/16", 1/4", 5/16", 3/8", 5/32" X 6", 3/16" X 6", 1/4" X 6", 3/8" X 6", 1/16, 5/64, 3/32, 7/64, 1/8, 9/64, 5/32, 3/16, 1/4	1890221
33-pc Set	3/8" x 6", 1/2" x 6", 5/8" x 6", 3/4" x 6", 7/8" x 6", 1/16, 5/64, 3/32, 1/8, 5/32, 3/16, 1/4, #1 Phillips, #2 Phillips, #3 Phillips, #1 Square, #2 Square, #3 Square, T15, T20, T25, #2 Phillips, #2 Square, T20, T25, 15/16", 15/16", 1/4"	1890206
33-pc Set	3/8" x 6", 1/2" x 6", 5/8" x 6", 3/4" x 6", 7/8" x 6", #1 Phillips, #2 Phillips, #3 Phillips, #1 Square, #2 Square, #3 Square, 6-8, 8-10, 10-12, T10, T15, T20, T25, T27, T30, #2 Phillips, #2 Square, T20, T25, 2- 31/32", 3-1/16"	1890207

### Slim Case Spade Bit Sets

5-pc Set	3/8", 1/2", 5/8", 3/4", 1", Slim Case	1891777
7-pc Set	3/8", 1/2", 5/8", 3/4", 7/8", 1", 6" Quick Change-Extension	1891773
8-pc Set	3/8", 1/2", 5/8", 3/4", 7/8", 1", 1-1/8", 1-1/2"	1891776
10-pc Set	1/4", 3/8", 1/2", 5/8", 3/4", 7/8", 1", 1-1/4", 1-3/8", 1-1/2", Slim Case	1891774
12-pc Set	3/8", 3/8", 1/2", 1/2", 5/8", 5/8", 3/4", 3/4", 7/8", 7/8", 1", 1", Slim Case	1891775

### Standard Length Spade Bit Bulk Packs

4-pc Bulk Pack	5/8"	1764343
4-pc Bulk Pack	3/4"	1764344
4-pc Bulk Pack	1"	1764345

### Lock-n-Load® Quick-Change Extensions

1/4" Quick-Change Bit Holder 2-1/2" OAL / 5/8" OAW	4935703
1/4" Quick-Change Bit Holder 6" OAL / 5/8" OAW	4935704
1/4" Quick-Change Bit Holder 12" OAL / 5/8" OAW	4935705

### Manual Locking Hex Key Extensions

1/4" Hex Key Extension 6" OAL / 1-1/16" OAW	88702
1/4" Hex Key Extension 12" OAL / 1-1/16" OAW	88601

Hex Key Extensions compatible with:



### IRWIN® Lock-n-Load® Quick-Change Extensions

#### QUICK-CHANGE BIT EXTENSION FEATURES

1. Lock-n-Load® system for quick release and fast bit changes.
2. Chrome-plated sleeve and body for improved durability and longer life.
3. Unique jaw design is compatible with 6-flatted shanks, ball detent (quick-change), and insert bits.
4. 1/4" range works with insert bits and is magnetic for additional holding power.



4935652

#### Lock-n-Load Compatibility

WOOD DRILLING

1/4"



- SPEEDBOR® Blue Groove (All Sizes)
- SPEEDBOR Max Speed (Sizes 7/16" to 1-1/4")
- Fastener Drive (All products)
- UNIBIT® (Sizes #1, #2, #10, #12)
- 1/4" Hole Saw Arbor (Sizes 9/16" to 1-3/16")
- Countersinks (Sizes #4 to #12)



3/8"



- SPEEDBOR Max Speed (Sizes 1-3/8", 1-1/4")
- UNIBIT (Sizes #3, #4, #11)
- 3/8" Hole Saw Arbor (Sizes 9/16" to 6" diameter saws)



7/16"



- 17" Ship Augers (Sizes 9/16" and larger)
- 7-1/2" Short Ship Augers (Sizes 1-1/8", 1-1/4")
- Self-Feed Bits (All sizes)
- UNIBIT (Sizes #5, #9, #13, #14, #20, #21)
- 1/2" Hole Saw Arbor (Sizes 1-1/4" - 6")



4935704

Description	Item #
1/4" Quick-Change Bit Holder 2-1/2" OAL / 5/8" OAW	4935703
1/4" Quick-Change Bit Holder 6" OAL / 5/8" OAW	4935704
1/4" Quick-Change Bit Holder 12" OAL / 5/8" OAW	4935705
3/8" Quick-Change Bit Holder 2-3/4" OAL / 7/8" OAW	4935651
3/8" Quick-Change Bit Holder 5-1/2" OAL / 7/8" OAW	4935652
3/8" Quick-Change Bit Holder 12" OAL / 7/8" OAW	4935653
7/16" Quick-Change Bit Holder 5-1/2" OAL / 1-1/16" OAW	4935654
7/16" Quick-Change Bit Holder 12" OAL / 1-1/16" OAW	4935655
7/16" Quick-Change Bit Holder 18" OAL / 1-1/16" OAW	4935656
1/4" Quick-Change Bit Holder 18" OAL	1869515



88702

#### Manual Locking Hex Extensions

Description	Item #
1/4" Hex Key Extension 6" OAL / 1-1/16" OAW	88702
1/4" Hex Key Extension 12" OAL / 1-1/16" OAW	88601
7/16" Hex Key Extension 6" OAL / 1-1/16" OAW	3046001
7/16" Hex Key Extension 12" OAL / 1-1/16" OAW	3046002
7/16" Hex Key Extension 18" OAL / 1-1/16" OAW	3046003

Hex Key Extension Compatible With:



QUICK-CHANGE SHANK

HEX SHANK

ROUND SHANK

## Ship Auger Bits with WeldTec™

The IRWIN® with WeldTec™ ship auger is made stronger and lasts longer than any standard augers. It features a welded cutting edge that easily cuts through tough materials like nail-embedded wood. It has twice the nail cutting life of standard ship augers. With an aggressive screw-pitch for fast drilling, this bit is fully-forged for durability, and wide flutes provide chip removal with less binding.



### WeldTec™ SHIP AUGER BIT FEATURES

1. Unique welded cutting edge for extreme life in tough materials, including nail-embedded wood.
2. Aggressive screw-pitch for fast drilling.
3. Wide flutes for chip removal with less binding.
4. Fully-forged bit for durability.\*\*

3043011

**2X** NAIL CUTTING LIFE\*

\* Compared to standard IRWIN ship augers  
\*\* Fully forged on bits 3/4" diameter and larger



WOOD DRILLING

## 7.5" Ship Auger Bits with WeldTec™



1779343

Diameter	Twist Length	Overall Length	Item #
3/8"	5"	7-1/2"	1779135
7/16"	5"	7-1/2"	1779136
1/2"	5"	7-1/2"	1779137
9/16"	5"	7-1/2"	1779138
5/8"	5"	7-1/2"	1779139
11/16"	5"	7-1/2"	1779140
3/4"	5"	7-1/2"	1779341
13/16"	5"	7-1/2"	1779342
7/8"	5"	7-1/2"	1779343
15/16"	5"	7-1/2"	1779344
1"	5"	7-1/2"	1779345
1-1/16"	5"	7-1/2"	1779346
1-1/8"	5"	7-1/2"	1779347
1-1/4"	5"	7-1/2"	1779348
1-3/8"	5"	7-1/2"	1779349
1-1/2"	5"	7-1/2"	1779350

## 17" Ship Auger Bits with WeldTec™



3043011

Diameter	Twist Length	Overall Length	Item #	Bulk Item #
3/8"	12"	17"	3043004	3043004B
7/16"	12"	17"	4935570	4935571
1/2"	12"	17"	3043005	3043005B
9/16"	12"	17"	3043006	3043006B
5/8"	12"	17"	3043007	3043007B
11/16"	12"	17"	3043008	3043008B
3/4"	12"	17"	3043009	3043009B
13/16"	12"	17"	3043010	3043010B
7/8"	12"	17"	3043011	3043011B
15/16"	12"	17"	3043012	3043012B
1"	12"	17"	3043013	3043013B
1-1/16"	12"	17"	4935572	4935573
1-1/8"	12"	17"	3043014	3043014B
1-1/4"	12"	17"	3043015	3043015B
1-3/8"	12"	17"	4935574	4935575
1-1/2"	12"	17"	3043016	3043016B
1-5/8"	12"	17"	—	1773957
1-3/4"	12"	17"	—	1773958
2"	12"	17"	—	1773959



47416

### Ship Auger Bits

- Durable hardened, resharpenable cutting edge for long life in tough materials, including nail-embedded wood.
- Wide flutes for chip removal with less binding.
- Aggressive screw-pitch for fast drilling.
- Fully-forged bit for durability.

Diameter	Shank Size	Twist Length	Overall Length	Tubed Item #	Bulk Item #
<b>12" Bits</b>					
1/2"	7/16"	9"	12"	-	48508
9/16"	7/16"	9"	12"	-	48509
11/16"	7/16"	9"	12"	-	48511
13/16"	7/16"	9"	12"	-	48513
<b>17" Bits</b>					
3/8"	3/8"	12"	17"	47406	-
7/16"	3/8"	12"	17"	47407	-
1/2"	7/16"	12"	17"	47408	-
9/16"	7/16"	12"	17"	47409	-
5/8"	7/16"	12"	17"	47410	-
11/16"	7/16"	12"	17"	47411	-
3/4"	7/16"	12"	17"	47412	-
13/16"	7/16"	12"	17"	47413	-
7/8"	7/16"	12"	17"	47414	-
15/16"	7/16"	12"	17"	47415	-
1"	7/16"	12"	17"	47416	-
1-1/16"	7/16"	12"	17"	47417	-
1-1/8"	7/16"	12"	17"	47418	-
1-1/4"	7/16"	12"	17"	47420	-
1-3/8"	7/16"	12"	17"	47422	-
1-1/2"	7/16"	12"	17"	47424	-
<b>18" Bits</b>					
9/16"	7/16"	15"	18"	-	48709
11/16"	7/16"	15"	18"	-	48711
13/16"	7/16"	15"	18"	-	48713
15/16"	7/16"	15"	18"	-	48715
1-1/16"	7/16"	15"	18"	-	48717



## Pole Auger Bits with WeldTec™

### POLE AUGER BIT FEATURES

1. Welded high speed steel cutting edge is sharper and larger so it cuts faster and lasts longer in dense, treated, or creosote-soaked wood.\*
2. Feed screw is 50% larger and has a 10% faster pitch and is designed specifically for drilling deep holes in dense wood.\*
3. Flutes are nearly two times wider for maximum chip removal in deep holes.\*
4. Clean cutting spur is located opposite the cutting edge. It scribes the hole before cutting for clean, fast drilling and more efficient transfer of chips to the flute, enhancing overall drilling speed.
5. Available in both 7/16" and 5/8" impact rated shank sizes.

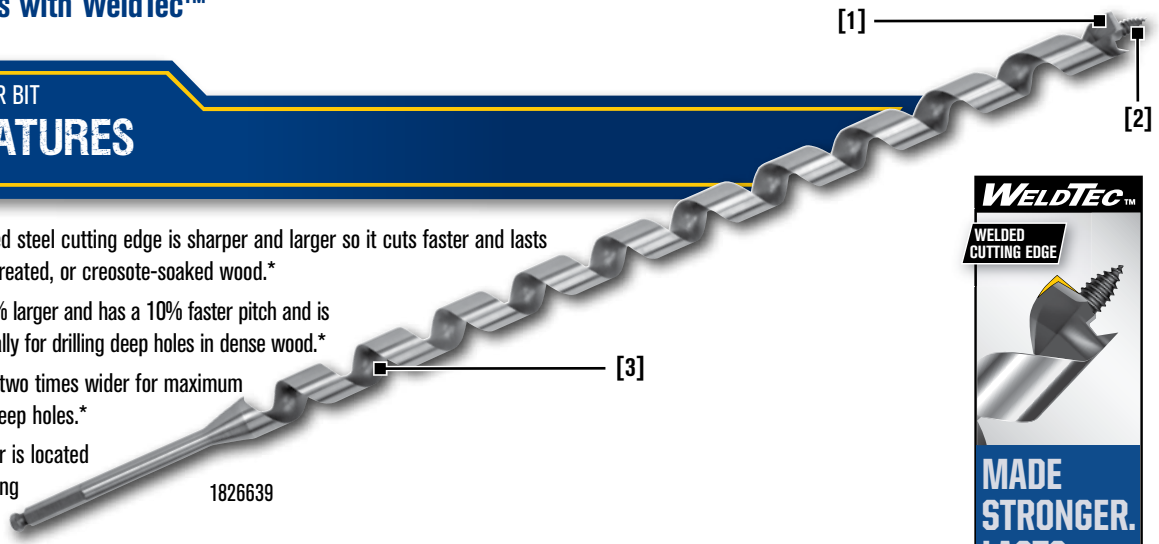

\* vs. standard pole augers.

### 18" Pole Auger Bits with WeldTec™



1826635

Diameter	Shank Size	Twist Length	Overall Length	Item #
11/16"	5/8"	15"	18"	1826304
11/16"	7/16"	15"	18"	1826632
13/16"	5/8"	15"	18"	1826305
13/16"	7/16"	15"	18"	1826633
15/16"	5/8"	15"	18"	1826626
15/16"	7/16"	15"	18"	1826634
1-1/16"	5/8"	15"	18"	1826627
1-1/16"	7/16"	15"	18"	1826635

### 24" Pole Auger Bits with WeldTec™



1826639

Diameter	Shank Size	Twist Length	Overall Length	Item #
11/16"	5/8"	21"	24"	1826628
11/16"	7/16"	21"	24"	1826636
13/16"	5/8"	21"	24"	1826629
13/16"	7/16"	21"	24"	1826637
15/16"	5/8"	21"	24"	1826630
15/16"	7/16"	21"	24"	1826638
1-1/16"	5/8"	21"	24"	1826631
1-1/16"	7/16"	21"	24"	1826639

### 29" Pole Auger Bits with WeldTec™



1826649

Diameter	Shank Size	Twist Length	Overall Length	Item #
1/2"	7/16"	24"	29"	1826640
9/16"	7/16"	24"	29"	1826641
5/8"	7/16"	24"	29"	1826642
11/16"	7/16"	24"	29"	1826643
3/4"	7/16"	24"	29"	1826644
13/16"	7/16"	24"	29"	1826645
7/8"	7/16"	24"	29"	1826646
15/16"	7/16"	24"	29"	1826647
1"	7/16"	24"	29"	1826648
1-1/16"	7/16"	24"	29"	1826649

WOOD DRILLING



46616



### Pole Auger Bits - Hand Brace / Adapter Shank

- Extra-long twist is ideal for drilling large poles, construction timbers, and for other timber applications.
- Cutting spur scribes the outside of the hole during drilling for a smooth, clean hole.
- Taper square shank can be removed for use in an electric drill or hand brace.
- Bit can be resharpened.
- Medium-fast screw point is ideal for general wood drilling applications.

Diameter	Shank Type	Twist Length	Overall Length	Bulk Item #
3/8"	Taper Square	12"	18"	46606
7/16"	Taper Square	12"	18"	46607
1/2"	Taper Square	12"	18"	46608
9/16"	Taper Square	12"	18"	46609
5/8"	Taper Square	12"	18"	46610
11/16"	Adapter Shank	12"	18"	46611
3/4"	Adapter Shank	12"	18"	46612
13/16"	Adapter Shank	12"	18"	46613ZR
7/8"	Adapter Shank	12"	18"	46614
15/16"	Adapter Shank	12"	18"	46615
1"	Adapter Shank	12"	18"	46616

#### Adapter Shank

Fits both hand braces and power drills.



Taper square shank fits hand braces.



Cut off or square and use in both power drills and hand braces.



47915



### Pole Auger Bits - Impact Shank

- Extra-long twist is ideal for drilling large poles, construction timbers, and for other timber applications.
- Cutting spur scribes the outside of the hole during drilling for a smooth, clean hole.
- Hex shank design for use in impact wrench drills.
- Bit can be resharpened.
- Medium-fast screw point is ideal for general wood drilling applications.

Diameter	Shank Size	Twist Length	Overall Length	Bulk Item #
9/16"	5/8"	15"	18"	48109
11/16"	5/8"	15"	18"	48111ZR
13/16"	5/8"	15"	18"	48113ZR
9/16"	7/16"	15"	18"	47909
11/16"	7/16"	15"	18"	47911
13/16"	7/16"	15"	18"	47913
15/16"	7/16"	15"	18"	47915
1-1/16"	7/16"	15"	18"	47917
1-1/16"	5/8"	21"	24"	48317
11/16"	5/8"	21"	24"	48311
13/16"	5/8"	21"	24"	48313
15/16"	5/8"	21"	24"	48315
11/16"	7/16"	21"	24"	48211
13/16"	7/16"	21"	24"	48213ZR
15/16"	7/16"	21"	24"	48215



47016



### Pole Auger Bits – Hex Shank

- Extra-long twist is ideal for drilling in large poles, construction timbers, and for multiple timber applications.
- All bits feature 7/16" adaptable hex shank. Simply remove it to use round shank.
- Bit can be resharpened.
- Medium-fast screw point is ideal for general wood drilling applications.
- Cutting spur scribes the outside of the hole during drilling for a smooth, clean hole.

Diameter	Shank Size	Twist Length	Overall Length	Bulk Item #
9/16"	7/16"	12"	17"	46809
5/8"	7/16"	12"	17"	46810
11/16"	7/16"	12"	17"	46811
3/4"	7/16"	12"	17"	46812
13/16"	5/8"	12"	17"	46813
1-1/16"	7/16"	12"	18"	46617
9/16"	7/16"	12"	23"	46909
5/8"	7/16"	18"	23"	46910
11/16"	7/16"	18"	23"	46911
3/4"	7/16"	18"	23"	46912
13/16"	7/16"	18"	23"	46913ZR
7/8"	7/16"	18"	23"	46914ZR
15/16"	7/16"	18"	23"	46915ZR
11/16"	7/16"	18"	24"	46711
13/16"	7/16"	18"	24"	46713ZR
1"	7/16"	18"	24"	46716
9/16"	7/16"	24"	29"	47009
5/8"	7/16"	24"	29"	47010
11/16"	7/16"	24"	29"	47011
3/4"	5/8"	24"	29"	47012
13/16"	7/16"	24"	29"	47013
7/8"	7/16"	24"	29"	47014
15/16"	7/16"	24"	29"	47015
1"	7/16"	24"	29"	47016
1-1/16"	7/16"	24"	29"	47017



45516

### Drilling Machine Auger Bits – 62R Series, 1/2" Round Shank

- Round shank is designed for use in power drills, drill presses, and drilling machines with 1/2" or larger chuck.
- Heavy stem increases strength and rigidity while reducing vibration. Shank length is 2".
- Medium-fast screw point is ideal for general wood drilling applications.

Diameter	Shank Size	Twist Length	Overall Length	Bulk Item #
7/16"	1/2" Round	6"	8"	45307
1/2"	1/2" Round	6"	8"	45308
9/16"	1/2" Round	6"	8"	45309
11/16"	1/2" Round	6"	8"	45311
13/16"	1/2" Round	6"	8"	45313
7/8"	1/2" Round	6"	8"	45314
1"	1/2" Round	6"	8"	45316
3/8"	1/2" Round	8"	10"	45406
7/16"	1/2" Round	8"	10"	45407
9/16"	1/2" Round	8"	10"	45409
3/4"	1/2" Round	8"	10"	45412
13/16"	1/2" Round	10"	12"	45513
1"	1/2" Round	10"	12"	45516
3/8"	1/2" Round	12"	14"	45606
1/2"	1/2" Round	12"	14"	45608
11/16"	1/2" Round	12"	14"	45611
3/4"	1/2" Round	12"	14"	45612
13/16"	1/2" Round	12"	14"	45613
7/8"	1/2" Round	12"	14"	45614
1"	1/2" Round	12"	14"	45616



49916



### Solid Center Auger with Cutting Spur – I-100 Series

- Single cutting spur scribes the outside of the hole for fast drilling, clean holes, and a smooth finish.
- Solid-center design increases durability and provides rigidity for smooth, straight drilling.
- Coarse screw-point for fast drilling in soft and hard woods.
- Full-length heat-treating strengthens the twist, guarding against bending in tough applications, and improves overall bit durability and drilling life.

Diameter	Shank Size	Twist Length	Overall Length	Item #
1/4"	3/16"	4-1/2"	7-1/2"	49904
5/16"	7/32"	4-1/2"	7-1/2"	49905
3/8"	5/16"	4-1/2"	7-1/2"	49906
7/16"	5/16"	4-1/2"	7-1/2"	49907
1/2"	5/16"	4-1/2"	7-1/2"	49908
9/16"	5/16"	4-1/2"	7-1/2"	49909
5/8"	5/16"	4-1/2"	7-1/2"	49910
11/16"	5/16"	4-1/2"	7-1/2"	49911
3/4"	5/16"	4-1/2"	7-1/2"	49912
13/16"	5/16"	4-1/2"	7-1/2"	49913
7/8"	5/16"	4-1/2"	7-1/2"	49914
15/16"	5/16"	4-1/2"	7-1/2"	49915
1"	5/16"	4-1/2"	7-1/2"	49916
1-1/8"	7/16"	4-1/2"	7-1/2"	49918
1-1/4"	7/16"	4-1/2"	7-1/2"	49920
1-3/8"	7/16"	4-1/2"	7-1/2"	49922
1-1/2"	7/16"	4-1/2"	7-1/2"	49924
<b>Solid Center Auger Bit Sets</b>				
6-pc pouched contains 1/4", 3/8", 1/2", 5/8", 3/4" & 1"				49998
3-pc pouched contains 1/4", 3/8", & 1/2"				49999
<b>Hex Key Extensions</b>				
5/16" Hex Key Extension			18"	43805
7/16" Hex Key Extension			18"	3046003



43616

### Hand Brace Solid Center Auger Bits – 62T Series

- Medium-fast screw point is ideal for general wood drilling applications.
- Full-length, heat-treated bit guards against bending in heavy-duty applications, and strengthens the twist where the greatest strain occurs.
- Double spur, double cutter design leaves an extremely clean hole finish.

Diameter	Shank Type	Twist Length	Overall Length	Item #	Bulk Item #
1/4"	Taper square	3-1/2"	7-1/2"	43604	—
5/16"	Taper square	3-5/8"	7-5/8"	43605	—
3/8"	Taper square	3-3/4"	7-3/4"	43606	—
7/16"	Taper square	3-7/8"	7-7/8"	43607	—
1/2"	Taper square	4"	8"	43608	—
9/16"	Taper square	4-1/8"	8-1/8"	43609	—
5/8"	Taper square	4-1/4"	8-1/4"	43610ZR	—
11/16"	Taper square	4-3/8"	8-3/8"	43611	—
3/4"	Taper square	4-1/2"	8-1/2"	43612	—
13/16"	Taper square	4-5/8"	8-5/8"	43613ZR	—
7/8"	Taper square	4-9/16"	8-3/4"	43614	—
15/16"	Taper square	4-11/16"	8-7/8"	43615	—
1"	Taper square	4-13/16"	9"	43616	—
1-1/2"	Taper square	4-7/8"	9-1/2"	—	43624
13-pc Pouch Set Contains 1/4" - 1"					43697



45002

### Adjustable Wood Bits

- Adjustable cutting blade bores a variety of hole sizes (Cuts 19 hole sizes in increments of 1/8").
- Lockhead screw securely holds blade at desired drilling diameter.

Diameter	Shank Size	Usage	Overall Length	Item #
5/8" - 1-3/4"	9/32"	Drill Press / Hand Brace	5-1/2"	44801
7/8" - 3"	11/32"	Drill Press / Hand Brace	6-1/2"	45002
7/8" - 3"	—	Hand Brace	6-1/2"	44202

## FLEX SHANK INSTALLER

## FEATURES

1. Hole in flute for easy wire pulling through walls, ceilings and floors
2. 3-flatted shank prevents slipping in drill chuck and includes hole for wire pulling
3. Tapered flute for fast chip ejection, reduced binding, and smooth drilling



### Type A - Auger Tip

- Screw tip with aggressive pitch delivers easy starts and fast drilling
- Dual spurs for faster, cleaner holes and less breakout

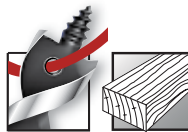

### Type B - Screw Tip

- Screw tip with aggressive pitch delivers easy starts and fast drilling

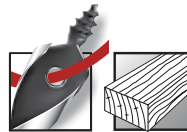

### Masonry

- Tungsten carbide tip for extended life in brick, block and mortar joints

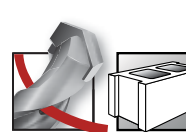

### HSS

- Unique combination of 135° self-centering split point stepped to 118° hole enlarging body for fast, easy starts and smooth drilling in metal, wood or plastic

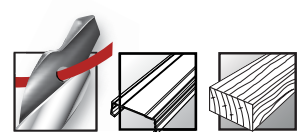

Diameter	Item #	Item #	Item #	Item #
<b>24" Length</b>				
1/4"	—	—	—	1890944
3/8"	1890746	1890767	—	1890945
1/2"	—	—	—	1890946
3/4"	1890747	—	—	—
1"	1890748	—	—	—
1-1/4"	1890749	—	—	—
<b>36" Length</b>				
1/4"	—	—	—	1890947
3/8"	1890750	1890768	—	1890948
1/2"	1890751	1890769	—	1890949
9/16"	1890752	1890770	—	—
3/4"	1890753	1890771	—	—
1"	1890754	—	—	—
<b>48" Length</b>				
1/4"	—	—	1890796	—
3/8"	—	—	—	1890950
3/4"	1890755	—	—	—
<b>54" Length</b>				
1/4"	—	—	—	1891001
3/8"	1890756	1890772	1890795	1891002
1/2"	1890757	1890773	1890797	1891003
9/16"	1890758	1890774	—	—
3/4"	1890759	1890775	—	—
1"	1890760	—	—	—
<b>72" Length</b>				
1/4"	—	—	—	1891004
3/8"	1890761	1890776	—	1891005
1/2"	1890762	1890777	1890798	1891006
9/16"	1890763	1890778	—	—
3/4"	1890764	1890779	—	—
1"	1890765	—	—	—
1-1/4"	1890766	—	—	—

# Wood Drilling

## Straight Shank Installers

### STRAIGHT SHANK INSTALLER FEATURES

1. Hole in flute for easy wire pulling through walls, ceilings and floors
2. 3-flatted shank prevents slipping in drill chuck and includes hole for wire pulling\*



#### Wood

- 82° point for fast, smooth drilling in wood

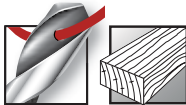

#### Masonry

- Tungsten carbide tip for extended life in brick, block and mortar joints

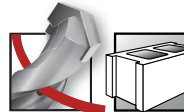

#### HSS

- 118° chisel point for easy starts and fast drilling in metal, wood or plastic

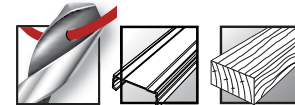

WOOD DRILLING

Diameter	Item #	Bulk Item #	Item #	Item #
<b>12" Length</b>				
1/4"	1890499	38904	1890723	1890617
5/16"	1890500	38905	—	—
3/8"	1890701	38906	—	1890618
1/2"	1890702	38908	1890724	1890619
9/16"	1890703	38909	—	—
5/8"	1890704	38910	—	—
3/4"	1890705	38912	—	—
<b>18" Length</b>				
3/16"	1890706	—	—	—
1/4"	1890707	39004	1890725	1890620
5/16"	1890708	39005	1890726	—
3/8"	1890709	39006	1890727	1890821
7/16"	1890710	39007	—	—
1/2"	1890711	39008	1890728	1890822
9/16"	1890712	—	—	—
5/8"	1890713	39010	1890729	—
3/4"	1890714	—	1890730	—
<b>24" Length</b>				
1/4"	1890715	—	1890731	1890823
3/8"	1890716	—	1890732	1890824
1/2"	1890717	—	—	1890825
<b>30" Length</b>				
1/4"	1890718	39604	—	1890826
3/8"	1890719	39606	—	1890827
1/2"	1890720	39608	—	—
<b>36" Length</b>				
1/4"	—	—	1890733	1890828
3/8"	1890721	—	1890734	1890829
<b>48" Length</b>				
1/4"	—	—	—	1890830
3/8"	1890722	—	1890735	1890831

\*Hole not included in 12" length bits



### FLEX SHANK EXTENSION

## FEATURES

1. Chuck is compatible with round, hex and quick-change shank drill bits
2. High carbon steel construction for durability and long life
3. Bits lock in place when set screw is tightened with hex key
4. 3-flatted shank prevents slipping in drill chuck and includes hole for wire pulling



### Flex Extensions



Length	Item #
<b>3/16" Connection Flex Extensions - Compatible with 1/4" - 9/16" Bits</b>	
36"	1890739
54"	1890740
72"	1890741
<b>1/4" Connection Flex Extensions - Compatible with 3/4" - 1-1/4" Bits</b>	
36"	1890736
54"	1890737
72"	1890738

### Wire & Cable Pulling Grips



Description	Item #
For 3/8" to 1/2" Wire and Cable	1890742
For 1/2" to 9/16" Wire and Cable	1890743
For 3/4" to 1" Wire and Cable	1890744

### Folding Placement Tool

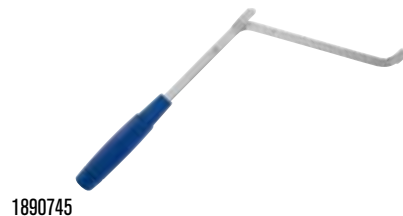

Description	Item #
36" Folding Placement Tool	1890745

### Bit Storage



Description	Item #
Hard Case - 48"	1804140
Hard Case - 78"	1804221

### Hex Bolt Bit



Length	Item #
3/8" Hex Bolt Bit	1966946
1/2" Hex Bolt Bit	1966947
5/8" Hex Bolt Bit	1966948

### WOOD COUNTERSINK FEATURES

1. Tapered drill with widened flutes for drilling fast, clean pilot holes, and ensures tight fit for screws
2. Adjustable four-cutter counterbore cuts and clears chips quickly for fast, smooth countersinking
3. Counterbore attaches to flats on shank with two hex screws for a secure fit, and can be adjusted for controlled pilot hole depth
4. 1/4" quick-change shank reduces slipping in standard chucks and is compatible with all 1/4" quick-change chucks, including impact drills
5. Adjustable stop collar attaches to counterbore with two hex screws for a secure fit and can be adjusted for desired counterbore depth (Included in sets only)

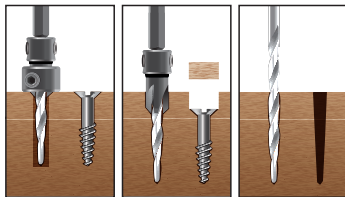

Countersink Counterbore Drill

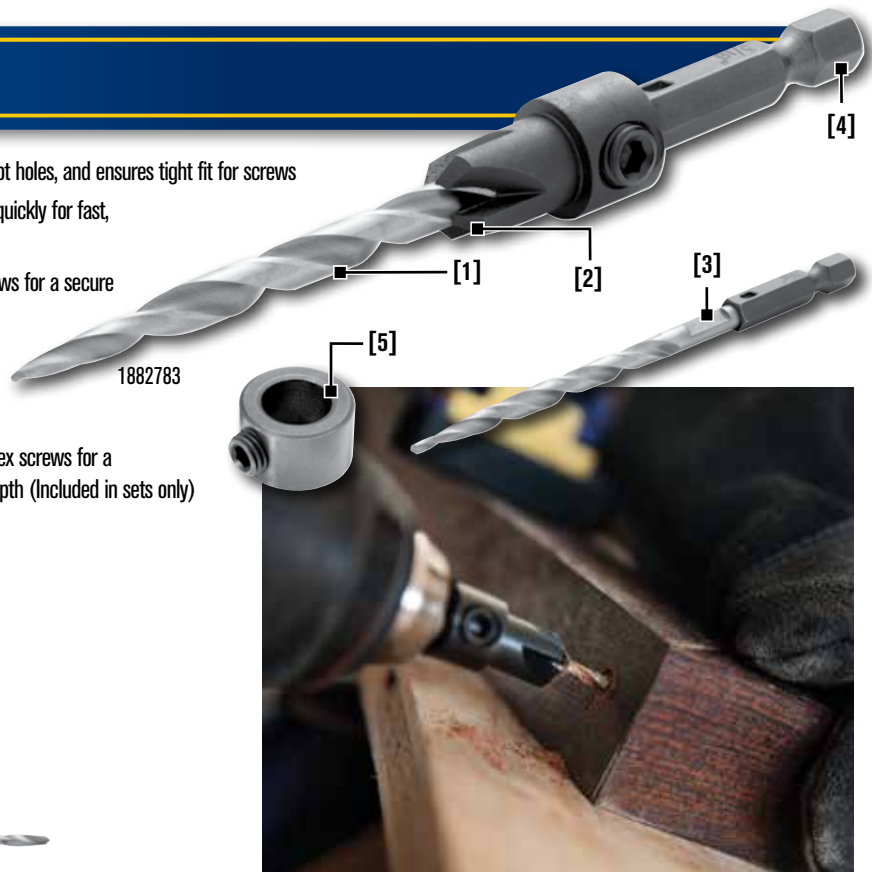

### Countersink Tools



1882783

Item #	Screw Size	Bit Diameter	Overall Length	Flute Length	Shank Size	Replacement Bit Item #	Counterbore Size	Plug Size	Size	Hex Key Size
<b>Tapered Bits</b>							<b>Counterbore</b>	<b>Stop Collar</b>		
1882630	#4	7/64" (2,8mm)	3-3/8" (86mm)	1-1/2" (38mm)	1/4" Quick-Change	1882786	1/4"	1/4"	Small	1/8"
1882781	#6	9/64" (3,6mm)	3-5/8" (92,5mm)	1-3/4" (45mm)	1/4" Quick-Change	1882787	5/16"	5/16"	Small	1/8"
1882782	#8	11/64" (4,4mm)	4" (101,8mm)	2-1/8" (54mm)	1/4" Quick-Change	1882788	3/8"	3/8"	Small	1/8"
1882783	#10	3/16" (4,8mm)	4-1/4" (108,2mm)	2-5/16" (59mm)	1/4" Quick-Change	1882789	7/16"	7/16"	Small	1/8"
1882784	#12	7/32" (5,6mm)	4-1/2" (114,5mm)	2-1/2" (64,5mm)	1/4" Quick-Change	1882790	7/16"	7/16"	Large	1/8"
1882785	# 14	1/4" (6,4mm)	4-3/4" (120mm)	2-3/4" (70mm)	1/4" Quick-Change	1882791	1/2"	1/2"	Large	1/8"

### Replacement Bits



1882789

Item #	Bit Diameter	Replacement Bit For
1882786	7/64" (2,8mm)	1882630
1882787	9/64" (3,6mm)	1882781
1882788	11/64" (4,4mm)	1882782
1882789	3/16" (4,8mm)	1882783
1882790	7/32" (5,6mm)	1882784
1882791	1/4" (6,4mm)	1882785

### Sets

Description	Item #
4-Piece Set: #6, #8, #10, Small Depth Stop	1882793
8-Piece Set: #4, #6, #8, #10, #12, #14, Small Depth Stop, Large Depth Stop	1882792
19-Piece IMPACT Drill / Drive Set: #4, #6, #8, #10, Small Depth Stop, 14 Fastener Drive Bits	1890451



1882793



1882792



1890451

### WELDTEC SELF-FEED BITS

## FEATURES

1. Welded cutting edge for extreme life in tough materials, including nail-embedded wood
2. Replaceable screw-point tip is larger and more durable and pulls bit fast for clean, true holes\*
3. 7/16" hex impact shank reduces slipping in standard chucks and is compatible with all 7/16" impact wrench chucks

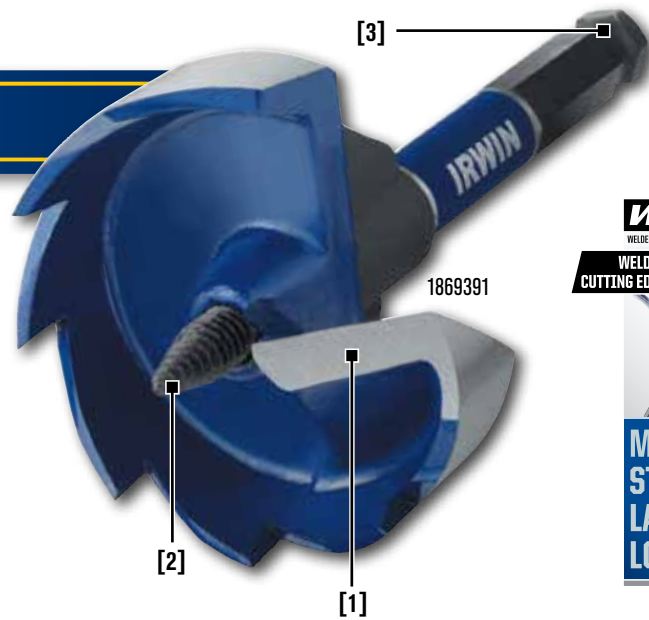

### WeldTec Self-Feed Bits

Diameter	Shank Size	Overall Length	Item #
1"	7/16"	5"	1869381
1-1/8"	7/16"	5"	1869382
1-1/4"	7/16"	5"	1869384
1-3/8"	7/16"	5"	1869385
1-1/2"	7/16"	5"	1869386
1-3/4"	7/16"	5"	1869387
2"	7/16"	5"	1869388
2-1/8"	7/16"	5"	1869389
2-1/4"	7/16"	5"	1869390
2-9/16"	7/16"	5"	1869391
3"	7/16"	5-3/8"	1869392
3-5/8"	7/16"	5-3/8"	1869393
4-5/8"	7/16"	5-3/8"	1869394

### Lock-n-Load® Quick-Change Extensions



4935655

Description	Item #
7/16" Quick-Change Bit Holder 5-1/2" OAL / 1-1/16" OAW	4935654
7/16" Quick-Change Bit Holder 12" OAL / 1-1/16" OAW	4935655
7/16" Quick-Change Bit Holder 18" OAL / 1-1/16" OAW	4935656

### Manual Locking Hex Key Extensions



3046002

Description	Item #
7/16" Manual Locking Hex Key Extensions 5-1/2" OAL / 1-1/16" OAW	3046001
7/16" Manual Locking Hex Key Extensions 12" OAL / 1-1/16" OAW	3046002
7/16" Manual Locking Hex Key Extensions 18" OAL / 1-1/16" OAW	3046003

### WeldTec Self-Feed Replacement Tips



1893936

Description	Item #
WeldTec Self-Feed Tips 1" to 1-3/8" Bits	1893035
WeldTec Self-Feed Tips 1-1/2" to 2-9/16" Bits	1893036
WeldTec Self-Feed Tips 3" to 4-5/8" Bits	1893037

\*vs. previous IRWIN self-feed bits

### SPEEDBOR MAX SELF-FEED BIT FEATURES

1. Three re-sharpenable cutting edges are hardened for extreme durability and long life in tough materials.\*
2. Replaceable screw-point tip pulls bit fast for clean, true holes.
3. 7/16" hex quick-change shank reduces slipping in standard chucks and is compatible with all 7/16" impact drills.



WOOD DRILLING

\* 2 cutting edges on sizes 3" and larger

### SPEEDBOR Max Self-Feed Wood Bits



Diameter	Shank Size	Overall Length	Item #
1"	7/16"	5"	3046004
1-1/8"	7/16"	5"	3046005
1-1/4"	7/16"	5"	3046006
1-3/8"	7/16"	5"	3046007
1-1/2"	7/16"	5"	3046008
1-3/4"	7/16"	5"	3046009
2"	7/16"	5"	3046010
2-1/8"	7/16"	5"	3046011
2-1/4"	7/16"	5"	3046012
2-9/16"	7/16"	5"	3046013
3"	7/16"	5"	3046014
3-5/8"	7/16"	5"	3046015
4-5/8"	7/16"	5"	3046016
<b>Replacement Tips - Includes (5) Screw Tips, (5) Set Screws, and (1) Hex Key</b>			
Self-feed tips 1" - 1-3/8" bits			1792762
Self-feed tips 1-1/2" - 2-9/16" bits			1792763
Self-feed tips 3" - 4-5/8" bits			1792764

## Brad Point Bits



49618

- Brad point tip provides accurate positioning for starting the hole.
- Bit is precision-ground for use in furniture making, doweling, cabinetry, and other woodworking applications where an exact hole size is required.
- Spurs reduce splintering and ensure a smooth, clean hole.
- Wide flutes provide a fast, continuous flow of chip ejection.

Diameter	Shank Size	Twist Length	Overall Length	Item #
1/8"	1/8"	1-7/16"	2-9/16"	49612
3/16"	3/16"	2-1/16"	3-3/8"	49613
1/4"	1/4"	2-1/2"	3-31/32"	49614
5/16"	5/16"	2-15/16"	4-19/32"	49615
3/8"	3/8"	3-7/16"	5-1/4"	49616
7/16"	3/8"	3-11/16"	5-19/32"	49617
1/2"	3/8"	3-31/32"	5-15/16"	49618

### Brad Point Drill Bit Set

5-pc pouched set contains 3/16", 1/4", 5/16", 3/8" & 1/2" 49600

## Forstner Bits



1966899

- Reduced shank fits 3/8" portable drills and drill presses.
- Brad point tip starts cleanly on uneven surfaces.

Diameter	Shank Size	Item #
1/4"	3/8"	1966894
3/8"	3/8"	1966895
1/2"	3/8"	1966896
5/8"	3/8"	1966897
3/4"	3/8"	1966898
7/8"	3/8"	1966899
1"	3/8"	1966900
1-1/8"	3/8"	1966931
1-1/4"	3/8"	1966932
1-3/8"	3/8"	1966933
1-1/2"	3/8"	1966934
1-5/8"	3/8"	1966935
1-3/4"	3/8"	1966936
1-7/8"	3/8"	1966937
2"	3/8"	1966938
2-1/8"	3/8"	1966939

### Forstner Bit Set

8-pc Set contains 5/8", 3/4", 7/8", 1" 1966892

14-pc Set contains 1/4", 1/4", 3/8", 1/2", 5/8", 3/4", 7/8", 1", 1-1/8", 1-1/4", 1-3/8", 1-1/2", 1-5/8", 2" 1966893

## Forstner Bit Set



1966892

## Plug Cutters



43910

- Recommended for covering fastener holes in furniture, cabinetry, floors, decks, and other woodworking projects.
- Constructed of hardened, high-carbon steel for added strength and durability.
- Ideal for making dowels.

Diameter	Shank Size	Item #
1/4"	1/4"	43904
3/8"	1/4"	43906
1/2"	1/4"	43908
5/8"	1/4"	43910