

Laboratory Exhaust Systems

Vektor™-MD Performance

Mixed Flow • High Plume Dilution

AMCA
260
Tested

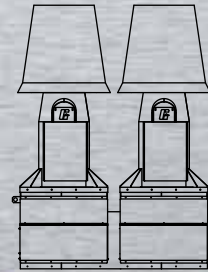

 **GREENHECK**
Building Value in Air.

March
2011

High Plume Dilution - Vektor Laboratory Exhaust System

The Greenheck Vektor™ High Plume Dilution Blower (patented) employs a unique discharge nozzle design that entrains additional ambient air, diluting the exhaust effluent from the laboratory, which reduces exhaust contaminant concentration. More important, the addition of the ambient air increases the Vektor's discharge windband mass flow and velocity, resulting in greater nozzle discharge momentum, displacing the diluted exhaust high above the roof.

How Vektor Technology Works...

Laboratory exhaust is drawn into the Vektor fan (A). The exhaust is discharged into the Vektor induction nozzle and ambient dilution air is induced into the Vektor nozzle (B). The laboratory exhaust plus induced dilution air is discharged at high velocity to atmosphere (C).

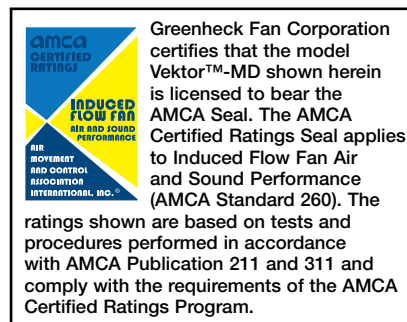
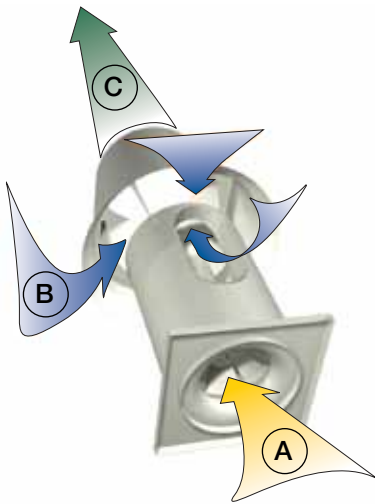

Vektor™-MD Inline Mixed Flow High Plume Dilution Blower



Why use the Greenheck Vektor Lab Exhaust System?

The main objective of a laboratory exhaust system is to remove hazardous or noxious fumes from a laboratory, dilute the fumes as much as possible and expel them from the lab building so that the fumes do not contaminate the roof area or become re-entrained into the building make-up air system.

The Greenheck Vektor™ High Plume Dilution Blower is a self-contained laboratory exhaust system, which offers the following benefits:

- Significant plume rise without unsightly exhaust stacks that detract from buildings aesthetics
- Significant dilution of laboratory exhaust, reducing levels of contaminant concentration
- Inline mixed flow configuration
- Reliable belt or direct drive systems
- Efficient and quiet blower technology
- Unique “vacuum shaft seal” ensuring that hazardous or noxious fumes do not escape through the shaft opening (patent pending)
- AMCA class C or B spark-resistant construction
- L₁₀ 200,000 hour minimum life fan shaft bearings
- Premium high-efficiency motor as standard
- Application to constant or variable volume exhaust systems
- Efficient discharge nozzle design
- LabCoat™ a two-part corrosion-resistant baked polyester resin powder coating with zinc-rich epoxy primer
- Safe and easy maintenance
- Flow applications from 1,500 - 80,000 cfm and up to 8 in. ESP per fan
- Multiple fan assemblies on a factory provided common plenum
- Meets ANSI Z9.5, UL 705, and ASHRAE lab design guidelines

No one tests and certifies performance like Greenheck!

Design Features

- Uses roof mounted inline blower to remove and dilute laboratory exhaust
- Ideal for applications:
 - Where roof space is limited (minimal footprint)
 - Demands high levels of exhaust at moderate to high static pressures
- Utilizes mixed flow impeller technology (U.S. Patent 7048499)

Benefits:

- Efficient operation for reduced energy consumption
- Lower overall sound levels - 5-20 dB less than inline centrifugal or axial exhaust fans

Construction:

- Heavy-gauge, welded steel
- Available with AMCA spark C or B construction
- LabCoat™ electrostatically powder coated with corrosion-resistant Hi-Pro Polyester and zinc-rich epoxy primer – Dark Gray 041 (standard)
- Range of optional colors available
- Lifting lugs and guards manufactured with coated stainless or galvaneal steel

Bypass Air Plenums:

- Single or multiple Vektor-MD inline exhaust blowers
- Modular in design to easily adapt to different configurations
- Can be added to a system on retrofits
- Available in single- or double-wall construction
- Designed to handle windloads up to 125 mph without guy wires
- Bypass air and isolation dampers
 - Low-leakage airfoil blades
 - LabCoat™ electrostatically powder coated with corrosion-resistant Hi-Pro Polyester and zinc-rich epoxy primer Dark Gray 041 (standard)
 - Sized specifically for each application
 - Factory-mounted electric or pneumatic actuators available

Features

Belt Drive

- AMCA arrangement 9
- Provides safe, easy inspection and maintenance of fan drive components
- Housing is bifurcated with motor, belts, and bearings located outside of contaminated airstream
- Motor or drive replacement does not require removal of fan from the system or exposure to contaminated interior
- Drive sized for 200% of the motor horsepower
- Minimum of two drive belts
- Ability to adjust fan RPM to compensate for system static pressure variations (balancing) and future system performance requirements

Direct Drive

- AMCA arrangement 2
- Utilizes a unique design offering safe and easy motor replacement
- Utilizes a single rigid self-aligning coupling, connecting the motor shaft to the impeller shaft
- Motor bearings do not support the weight of fan impellers: Longer motor life

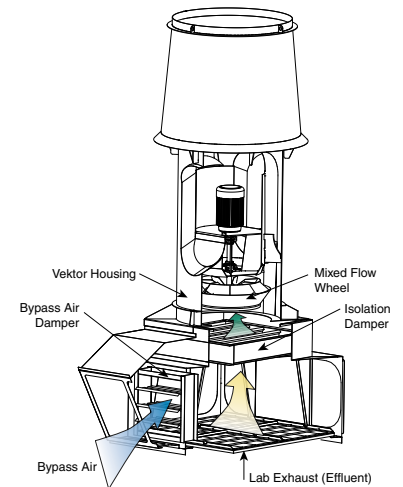

Laboratory Exhaust Systems

Model Vektor™-MD

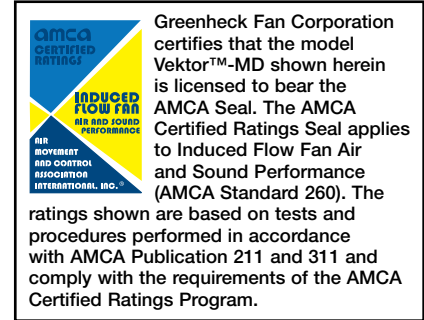

AMCA Induced Flow Licensed

The Air Movement and Control Association (AMCA) International, Inc. has introduced AMCA Standard 260, “Laboratory Methods of Testing Induced Flow Fans for Rating.” Induced flow fans, also known as high plume dilution blowers, are used to dilute hazardous laboratory exhaust and disperse the exhaust high into the atmosphere, away from possible re-entrainment zones. Prior to AMCA Standard 260, high plume dilution blowers fell outside the scope of AMCA performance certification. Now, AMCA Standard 260 can provide consulting and facility engineers independent performance verification for critical laboratory exhaust applications that they insist on for other fans and blowers used in general HVAC applications.

Greenheck's Vektor™-MD is licensed to bear the AMCA Induced Flow Fan Air and Sound Certified Ratings Seal. Each fan size has been tested in our AMCA accredited air and sound laboratory and their performance as cataloged is assured. The AMCA Induced Flow Fan seal encompasses the following AMCA test standards:

- ANSI/AMCA Standard 210, “Laboratory Methods of Testing Fans for Certified Aerodynamic Performance Rating”
- AMCA Standard 260, “Laboratory Methods of Testing Induced Flow Fans for Rating”
- AMCA Standard 300, “Reverberant Room Method for Sound Testing of Fans”

Visit <http://www.AMCA.org> for more information regarding AMCA Standards and Publications.

Laboratory Exhaust System Terminology

Bypass Air - Ambient air that is drawn through the bypass air plenum and mixed with the lab exhaust to increase dilution and plume rise. Bypass air is primarily utilized in variable volume applications to maintain a constant discharge volume.

Dilution - The ratio of the total fan outlet volume to the lab exhaust volume.

Effective Plume Height - Sum of the discharge plume rise, plus the added height of the laboratory exhaust system above the roof-deck level. (See diagram on page 6)

Entrained Air - Air that is drawn through the windband and mixed with the lab exhaust to increase the dilution and plume rise.

Lab Exhaust - Air that is being exhausted from the laboratory.

Nozzle - Located at the discharge of the fan housing, the nozzle is used to accelerate the exhaust air as it enters the windband.

Plume Rise - The height of the propelled lab exhaust and dilution air above the discharge of the windband.

Total Airflow - The sum of the lab exhaust, bypass air, and entrained air.

Windband - Device used to direct the lab exhaust as it leaves the housing of the exhaust fan and entrain dilution air.

Variable Nozzle Technology (VNT) - Greenheck Vektor-MD exhaust fans offer multiple nozzles and windbands to optimize the plume rise, efficiency, and sound levels of the fan. Greater nozzle velocities result in increased air entrainment and higher plume rise.

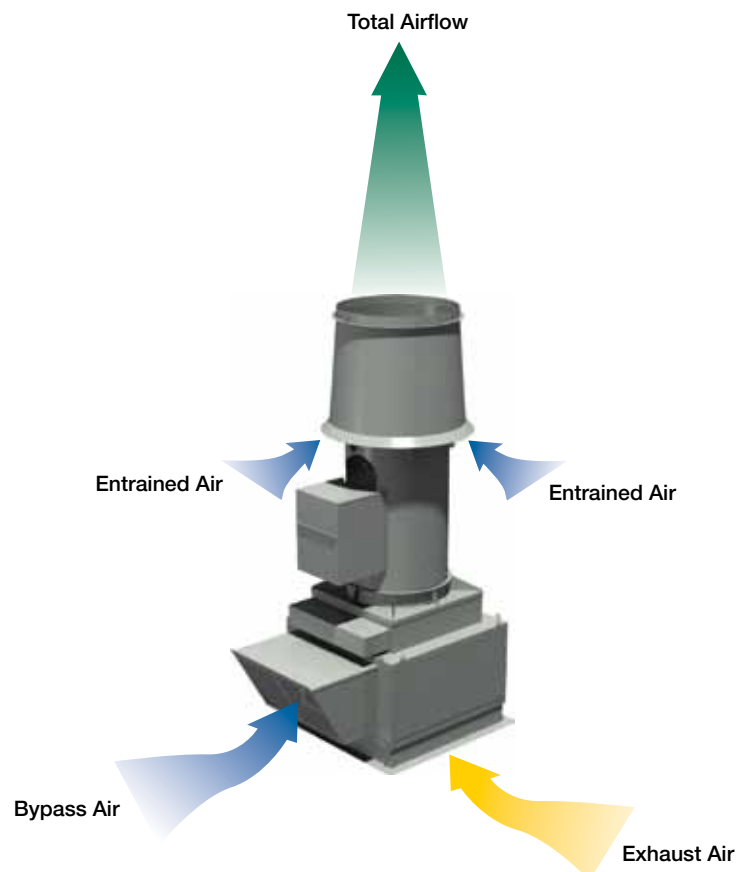
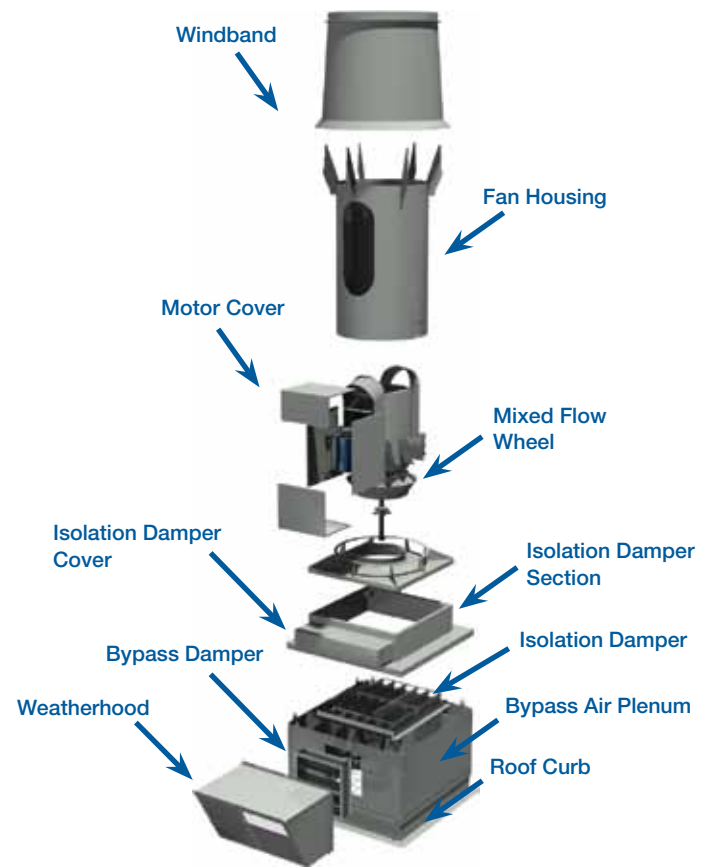

The following illustrations describe the procedure for determining the total laboratory exhaust fan discharge flow. The total discharge flow is the sum of inlet airflow and entrained airflow. The key requirement to AMCA 260 is the variable resistance box. This box allows the measurement of total discharge flow ($P_s = 0$ in. wg to simulate discharging the fan to atmosphere) at all points along its fan curve.

Without the variable resistance box, the entrained airflow can only be measured at the free air point of its fan curve. The entrained airflow obtained can be used to calculate an effective plume height. Therefore, AMCA 260 certification is necessary to ensure the laboratory exhaust fan specified is providing the plume rise and entrainment submitted.

ANSI/AMCA 210 Figure 15 Test

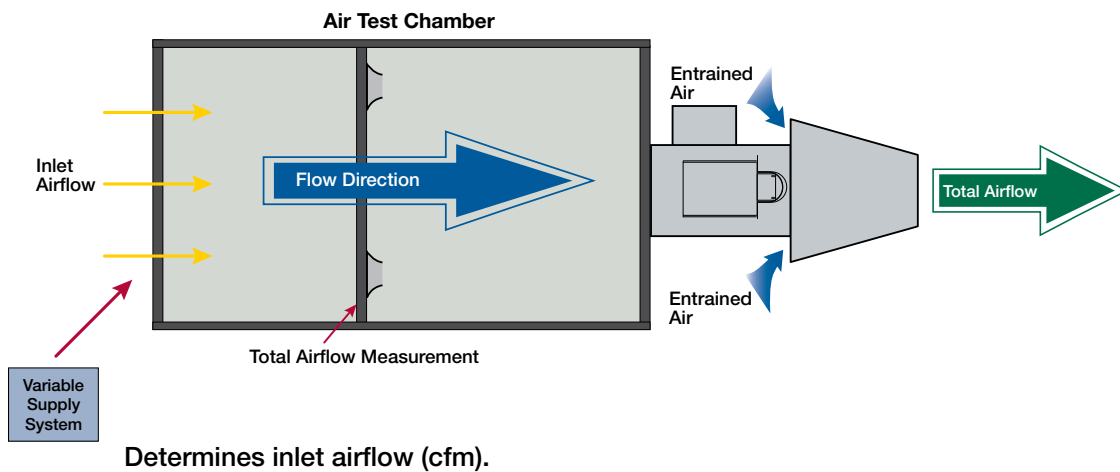

AMCA 260 Figure 1 Test

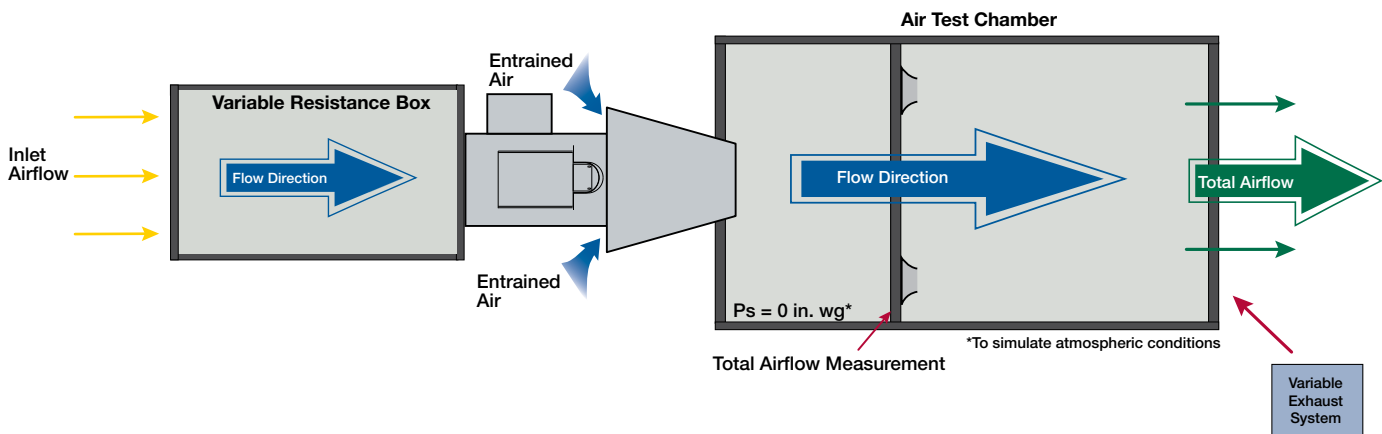

Determines outlet airflow (cfm) at the same inlet conditions measured in the Figure 15 test.

The entrainment ratio can be determined by dividing the outlet airflow from the AMCA 260 Figure 1 test, by the inlet airflow from the AMCA 210 Figure 15 test.

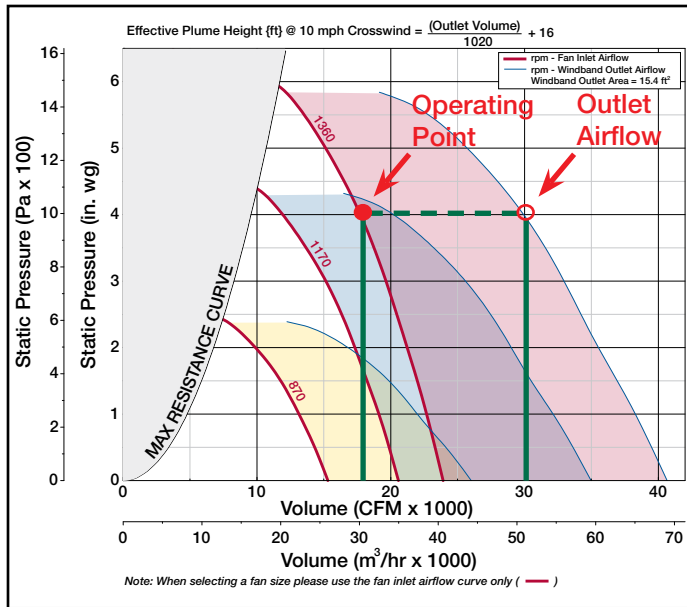

$$\text{Entrainment Ratio} = \frac{\text{Outlet Airflow}}{\text{Inlet Airflow}} \text{ or } \left(\frac{\text{Figure 1 test}}{\text{Figure 15 test}} \right)$$

$$\text{Entrainment Ratio} = \frac{30,000 \text{ cfm}}{17,500 \text{ cfm}} = 171 \%$$

AMCA 300 Sound Test Procedure

Greenheck is the first company in the laboratory exhaust fan industry to receive AMCA 260 certification and is also leading the industry when it comes to sound testing. Greenheck tests the outlet sound of the fan with the entire fan located inside the reverberant room according to AMCA 300 Figure 3 below.

Inlet Sound

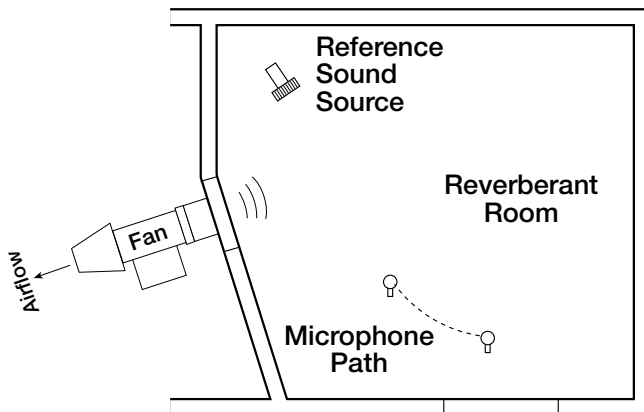

AMCA 300 Figure 2: Fan Inlet Testing
(Installation Type A: Free Inlet, Free Outlet)

Outlet Sound

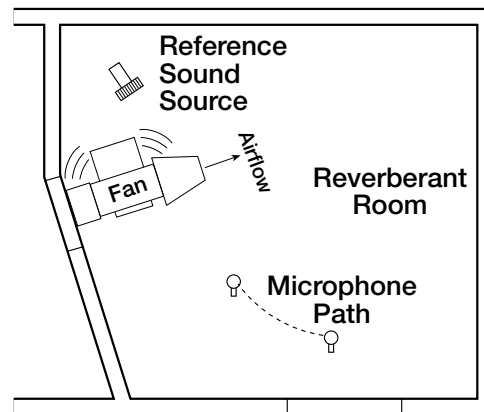

AMCA 300 Figure 3: Fan Outlet Testing
(Installation Type A: Free Inlet, Free Outlet)

All Vektor-MD high plume dilution blowers have been tested in our third party accredited sound laboratory and their performance as cataloged is assured.

Effective Plume Height

It is important that the exhaust plume height be great enough to avoid re-entrainment of exhaust air and to disperse the exhaust. The effective plume height should be used when analyzing design issues. The effective plume height (h_e) is the physical height of the fan system (h_s) plus the plume rise (h_r), found from the equation below.

The effective plume height is calculated using the following equation*:

$$h_e = h_r + h_s$$

$$h_e = [3.0 \times (V \times d / U)] + h_s$$

Note: Fan curves include effective plume height equations that are specific to the fan size located in the air data section of this catalog.

h_s = fan height (dimensions section of this catalog)

h_r = plume rise, ft (m)

V = windband exit velocity, ft/min (m/s)

d = windband diameter, ft (m)

U = wind speed, ft/min (m/s)**

* From ASHRAE Laboratory Design Guide, Equation 9-2

** Plume rises shown on performance pages are calculated with a 880 ft/min, [10 mph], (4.47 m/s) crosswind.

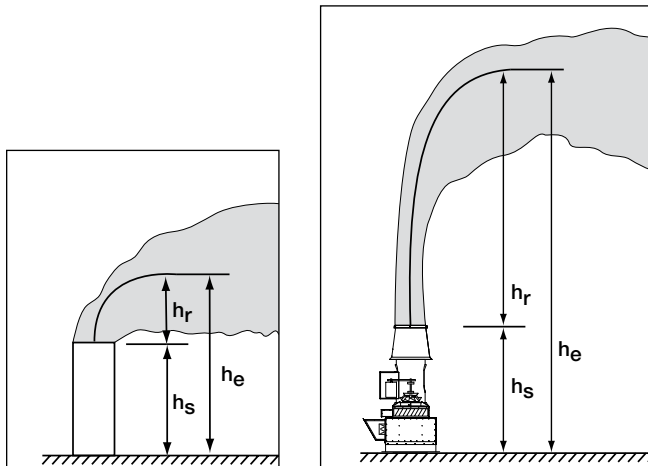

Note: Graphical comparison of Vektor-MD to low velocity, traditional stack.

Quick Select Chart					
Fan Size	Laboratory Exhaust		Effective Plume Height h_e		
		cfm	m ³ /h	ft.	m
15	Min	1,300	2,200	17	5.2
	Max	5,500	9,300	34	10.4
16	Min	1,600	2,700	19	5.8
	Max	7,000	11,900	39	11.9
18	Min	2,000	3,400	21	6.4
	Max	8,500	14,400	42	12.8
20	Min	2,500	4,200	22	6.7
	Max	10,500	17,800	47	14.3
22	Min	5,000	8,500	27	8.2
	Max	14,000	23,800	50	15.2
24	Min	6,000	10,200	28	8.5
	Max	17,500	29,700	52	15.9
27	Min	7,500	12,700	32	9.8
	Max	20,000	34,000	55	16.8
30	Min	9,000	15,300	34	10.4
	Max	25,000	42,500	62	18.9
33	Min	8,000	13,600	31	9.5
	Max	30,000	51,000	61	18.6
36	Min	9,500	16,100	33	10.1
	Max	35,000	59,500	65	19.8
40	Min	12,000	20,400	36	11.0
	Max	44,000	74,800	73	22.3
44	Min	14,000	23,800	40	12.2
	Max	54,000	91,700	75	22.9
49	Min	17,500	29,700	44	13.4
	Max	66,000	112,100	83	25.3

Note: Plume rise ranges shown above are based on 3,000 fpm (15.25 m/s) minimum discharge velocity per ANSI Z9.5 with a 10 mph (16.09 km/hr) crosswind per ASHRAE Applications Handbook.

Note: When manually selecting a fan it is important to remember that more than one fan is available to meet the desired performance. Selection criteria such as fan size, efficiency, speed, outlet velocity, horsepower, sound, or construction material may also dictate which fan is chosen.

Adjusting Plume Height

Adjusting the fan system to have additional throw or plume height is achieved by increasing the volume of air through the discharge nozzle. Simply changing the drive pulleys will increase fan speed and volume capacity, thus boosting flow momentum. The additional air through the fan comes from an increase in lab exhaust or an increase of air through a bypass air damper. Utilizing a bypass air damper to increase both dilution and mass flow of the exhaust air can optimize plume rise. Increased mass flow improves momentum and carries the diluted exhaust higher.

The plume height can also be adjusted by changing nozzles. A higher velocity nozzle results in higher outlet airflow, which in turn results in higher plume rise.

Air Temp. °F	Elevation (Feet Above Sea Level)															
	0	1000	2000	3000	4000	5000	6000	7000	8000	9000	10000	11000	12000	13000	14000	15000
-20	0.83	0.86	0.89	0.93	0.96	1.00	1.03	1.07	1.11	1.15	1.19	1.24	1.28	1.33	1.38	1.43
-10	0.85	0.88	0.91	0.95	0.98	1.02	1.06	1.09	1.14	1.18	1.22	1.27	1.31	1.36	1.41	1.46
0	0.87	0.90	0.93	0.97	1.00	1.04	1.08	1.12	1.16	1.20	1.25	1.29	1.34	1.39	1.44	1.50
10	0.89	0.92	0.95	0.99	1.03	1.06	1.10	1.14	1.19	1.23	1.28	1.32	1.37	1.42	1.47	1.53
32	0.93	0.96	1.00	1.04	1.07	1.11	1.15	1.20	1.24	1.29	1.33	1.38	1.44	1.49	1.54	1.60
50	0.96	1.00	1.03	1.07	1.11	1.15	1.20	1.24	1.29	1.33	1.38	1.44	1.49	1.54	1.60	1.66
70	1.00	1.04	1.08	1.12	1.16	1.20	1.24	1.29	1.34	1.39	1.44	1.49	1.55	1.60	1.66	1.72
100	1.06	1.10	1.14	1.18	1.22	1.27	1.31	1.36	1.41	1.47	1.52	1.58	1.63	1.69	1.76	1.82
125	1.10	1.14	1.19	1.23	1.28	1.32	1.37	1.42	1.48	1.53	1.59	1.65	1.71	1.77	1.84	1.90
150	1.15	1.19	1.24	1.28	1.33	1.38	1.43	1.48	1.54	1.60	1.66	1.72	1.78	1.85	1.91	1.98
175	1.20	1.24	1.29	1.34	1.39	1.44	1.49	1.55	1.60	1.66	1.72	1.79	1.85	1.92	1.99	2.07
200	1.25	1.29	1.34	1.39	1.44	1.49	1.55	1.61	1.67	1.73	1.79	1.86	1.93	2.00	2.07	2.15

Density Correction Factor Equation

$$DCF = ((T + 460)/530) \times 1.037(E / 1000)$$

DCF = Density Correction Factor

T = Temperature (degrees F)

E = Elevation above sea level (feet)

Air Density (lb/ft³) = 0.075 / DCF

Effects of Air Density

When selecting a fan to operate at a non-standard air density using standard air density tables and curves, corrections must be made to static pressure and brake horsepower.

At higher than standard elevations and temperatures, air density will be lower than standard. Therefore, static pressure must be determined at standard density that will equate to the specified static pressure at the operating density. Since standard air density is greater than operating air density in this instance, one would expect the corrected static pressure to be greater than the operating static pressure.

The following example shows how to select a Vektor-MD Size 30, 85% Wheel Width, Low Velocity (LV) Nozzle for 17,000 cfm, 4 in. wg, 1000 ft. elevation, and 125°F temperature.

1. Since the volume exhausted by the system is not affected by density, cfm remains 17,000.
2. Select the correction factor from the chart for 1000 ft. elevation and 125°F. Correction factor is 1.14.
3. Multiply specified static pressure (4 in. wg) by the correction factor (1.14) to determine standard air density equivalent static pressure. {4 in. wg x 1.14 = 4.56 in. wg}
4. Using the performance curves, enter 17,000 cfm and 4.56 in. wg of static pressure.
5. At the intersection of 17,000 cfm and 4.56 in. wg static pressure, the fan rpm is approximately 1450 rpm and Bhp is 20.
6. Since the horsepower selected refers to standard air density, this must be corrected to reflect actual Bhp at the lighter operating air. Remember, horsepower is less at a lower air density. Divide the Bhp required (20) by the correction factor (1.14) selected previously to determine the Bhp at the new operating conditions.
20/1.14 = 17.5 Bhp. This would require a minimum motor size of 20 hp.

Vektor-MD Selection: AMCA 260 Inlet Airflow Curves

Every laboratory or fume exhaust application has a unique set of criteria that must be evaluated in order to determine the most effective exhaust system. The selection of a Vektor-MD requires the lab exhaust volume (effluent) per fan along with a determination of the external static pressure. Other considerations when making fan selections include: sound requirements, electrical limitations, size constraints, and the effective plume height.

1) Determine the laboratory exhaust requirements

- Determine the lab exhaust volume per fan.
- Determine the external static pressure at the system inlet.

Bypass Air Plenums - Estimated Pressure Drop

- Variable volume lab exhaust systems require a bypass air plenum and damper.
- Greenheck's Computer Aided Product Selection (CAPS) software, automatically adds external system static pressure to account for the bypass air plenum and isolation damper.

2) Select the appropriate Vektor-MD

Select Vektor-MD fans with a minimum nozzle velocity of 3,000 feet per minute (ANSI Z9.5 and ASHRAE lab design guidelines), which is represented by the green vertical line in Figure 1.

- (A)** All Vektor-MD curves indicate the minimum cfm necessary to meet this minimum velocity.

3) Determine fan rpm

- Locate the fan operating point (the intersection of the required airflow and static pressure) on the inlet airflow in Figure 1.

(B) In this example, the operating point is 17,500 cfm at 4 in. wg.

The belt drive fan rpm can be estimated by comparing the operating point to any of the solid fan rpm curves and in this example, the operating point falls on the red 1360 rpm curve.

(C) Direct drive fan selections must use the 50 or 60 cycle rpm curves (yellow or blue curves).

- Determine the brake horsepower by comparing the operating point to the dashed brake horsepower curves.

In this example, the brake horsepower is above 15, but slightly less than 20 hp. A minimum of a 20 hp motor is recommended for this selection.

4) LV, MV and HV Nozzles

Each fan size is available with Low Velocity (LV), Medium Velocity (MV) or High Velocity (HV) nozzles.

- Multiple nozzles allow for the optimization of brake horsepower, plume rise and acoustic performance.

Note: For most applications, the LV or MV nozzles are recommended in order to limit the operating brake horsepower. HV nozzles are available for applications that require the highest plume rise.

Figure 1: Vektor-MD Size 30 Low Velocity 100% Wheel Width

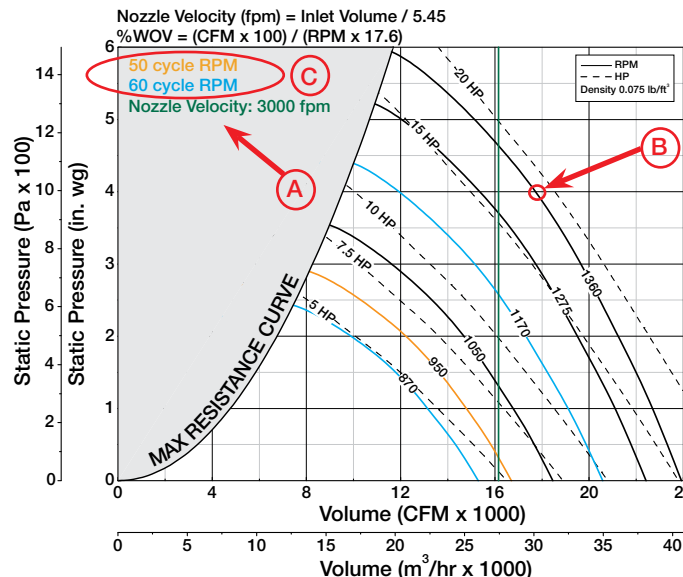

Vektor-MD Selection: AMCA 260 Outlet Airflow Curves

Figure 2 below illustrates the new AMCA 260 fan curves. Each fan has two performance curves associated with each rpm: the red curve is the flow through the fan and the blue curve directly to the right is the windband exit volume. These curves have been connected with shading.

1) Determining windband exit volume

- Find the operating point (E). Draw a horizontal line to the right from (E) to the blue windband exit curve (F).
- The windband exit volume is determined by (F), so the windband exit volume is 30,000 cfm.

2) Determining windband velocity, dilution ratio and effective plume height

Each Vektor-MD size and nozzle combination has a unique set of equations to determine the nozzle velocity, dilution ratio, and effective plume height. Since the operating point is 17,500 cfm at 4 in. wg, calculations are as follows for a Vektor-MD Size 30-LV.

$$\text{Windband Exit Volume} = 30,000 \text{ cfm}$$

$$\text{Nozzle Velocity} = 17,500 \text{ cfm} / 5.45 \text{ ft}^2 = 3211 \text{ ft/min}$$

$$\text{Dilution Ratio} = \text{Windband Exit Volume} / \text{Fan Inlet Airflow} = 30,000 \text{ cfm} / 17,500 \text{ cfm} = 171\%$$

$$\text{Effective Plume Height} = \left(\frac{\text{Outlet Volume}}{1020} \right) + 16$$

$$\left(\frac{30,000}{1020} \right) + 16 = 45 \text{ ft}$$

Note: Effective Plume Height includes the fan height of 16 ft. as indicated in the dimensions section of this catalog.

Determining Inlet and Outlet Sound

Along with the fan rpm, it is necessary to know the fan percent wide open volume (%WOV). The %WOV can be calculated using the equation posted adjacent to each fan curve.

$$\%WOV (\text{Vektor-MD-30-LV}) = (\text{cfm} \times 100) / (\text{rpm} \times 17.6). \text{ For this example, the \%WOV is } 73\%.$$

The sound power and sound pressure can be determined through linear interpolation between sound data provided at 1170 rpm and 1360 rpm.

Figure 2: Vektor-MD Size 30 Low Velocity 100% Wheel Width

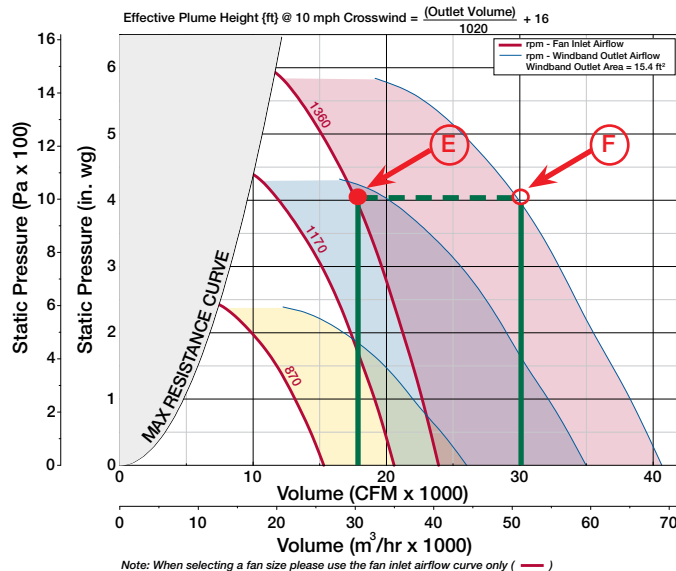

Vektor-MD Selection: Reading Fan Curves

There are several variables in selecting an appropriate Vektor-MD system including % wheel width and nozzle size. These factors will affect the required brake horsepower, fan RPM, and entrained air. As a general rule, the low velocity nozzle will require less brake horsepower than the high velocity nozzle, but entrained air and plume rise will be slightly less. Higher pressures can be achieved by using reduced % wheel widths. Belt drive units are available in 100%, 85%, and 70% wheel width. Direct drive units are available from 100% - 50% wheel width in increments of 5% (i.e. 95%, 90%).

Step 1: Identify necessary laboratory effluent (CFM), plume rise (ft), and % dilution. Enter the Vektor-MD quick select chart located on page 8 and identify unit sizes that can accommodate application specifications. Also determine if belt or direct drive is desired. For direct drive units, only the blue RPM curves are available for 60 cycle power and gold curves for 50 cycle power. Belt drive units are capable of operation at any RPM within the max fan class RPM (the last RPM curve).

Step 2: Using the guidelines above, locate fan size that generally suits specifications. Calculate necessary system pressure including isolation damper, bypass air plenum, and system drop. (See below) Enter the fan curve with the desired performance specifications: airflow (CFM), pressure (in. wg), and nozzle outlet velocity (fpm). This yields horsepower (HP) and RPM at the fan operation point. If the given point has a close proximity to a horsepower curve, the next larger motor horsepower should be selected.

Pressure Drop

Variable volume lab exhaust systems and systems that require additional bypass air, require a bypass air damper and plenum. When calculating necessary pressure, 0.2 in. wg must be added to the external system static pressure to account for the bypass air plenum. Add 0.15 in. wg if the system includes an isolation damper.

Vektor-MD Size 30

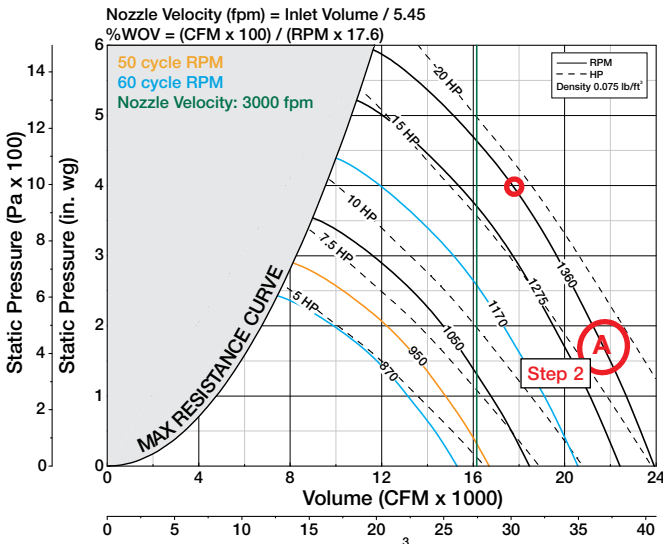

NOTE: All plots represent fan operation at standard air (70°C at sea level). ANSI Z9.5 specification requires a 3,000 fpm minimum nozzle outlet velocity.

Example A:

- Lab system A requires 17,500 cfm exhaust, 56 ft. plume rise, with an external static pressure of 4 in. wg.
- From the quick select chart, applicable unit sizes range from Vektor-MD size 24 to Vektor-MD size 44.
- Considering the desired performance criteria, a Vektor-MD size 30 Belt drive with 100% wheel width and low velocity nozzle (LV) is selected to optimize unit size and required horsepower.
- Locating this point on the curve (A), a 20 HP motor is needed to operate at 1360 RPM and provides 3,211 fpm nozzle velocity.
- Using the %WOV equation provided with the Vektor-MD size 30, 100% wheel width, LV nozzle air data chart, the %WOV can be calculated:
 $\%WOV = (17,500 \times 100) / (1360 \times 17.6) = 73 \% \text{WOV}$

Vektor-MD Model Guide

Vektor-MD-15-9-85-LV-HVW

Vektor MD - Mixed Flow,
 High Plume Dilution
 Fan Size — Sizes 15 - 49
 Fan Arrangement
 9 = Belt Drive
 2 = Direct Drive

Windband Type
 HVW = High Velocity Windband
 HPW = High Plume Windband
 Nozzle Type
 LV = Low Velocity
 MV = Medium Velocity
 HV = High Velocity
 Wheel Width
 50 - 100% in increments of 5%

Size 15

Size 16

Size 18

Size 20

Size 22

Size 24

Size 27

Size 30

Size 33

Size 36

Size 40

Size 44

Size 49

VEKTOR™ Performance

Inlet Airflow

100% Wheel Width

Outlet Airflow

LV
Low Velocity

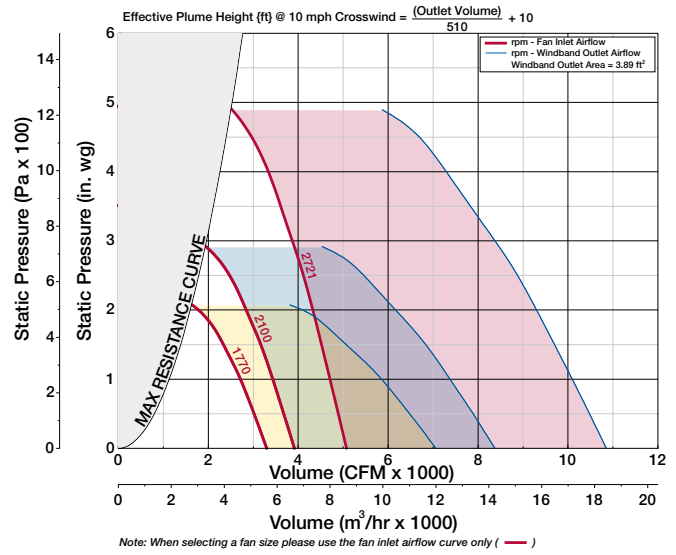
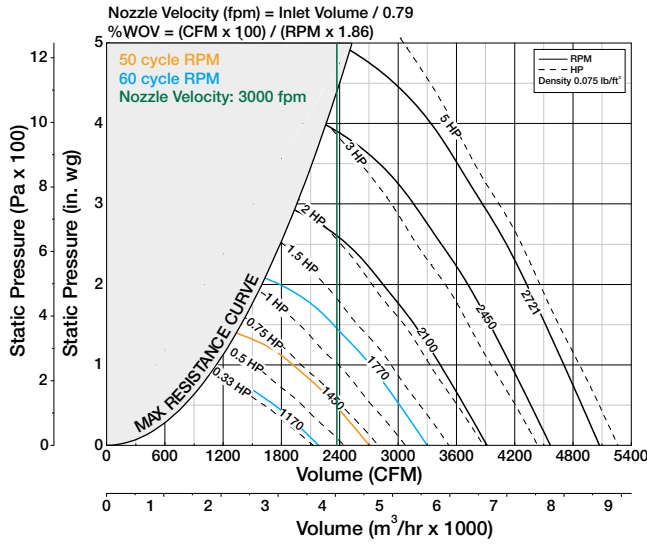

MV
Medium Velocity

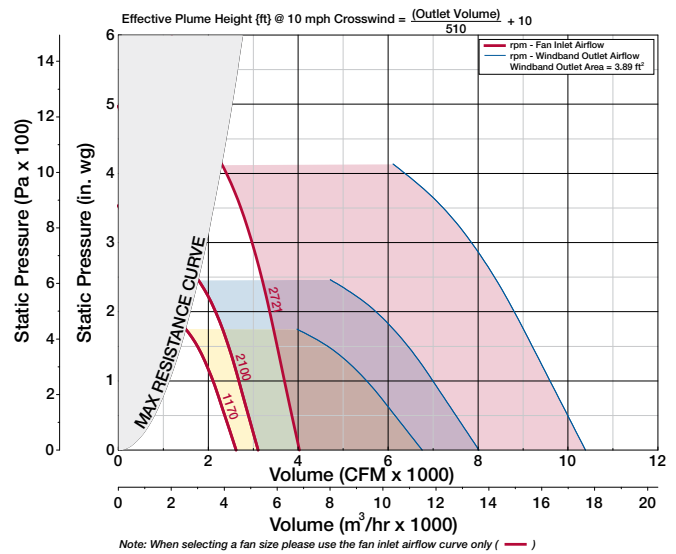
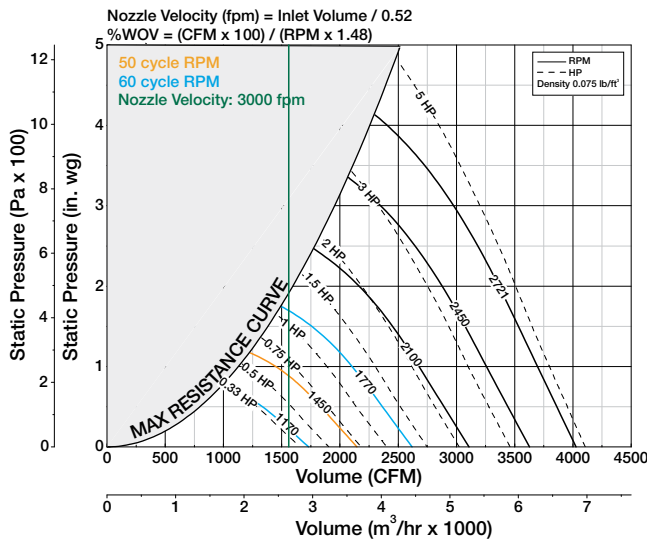

HV
High Velocity

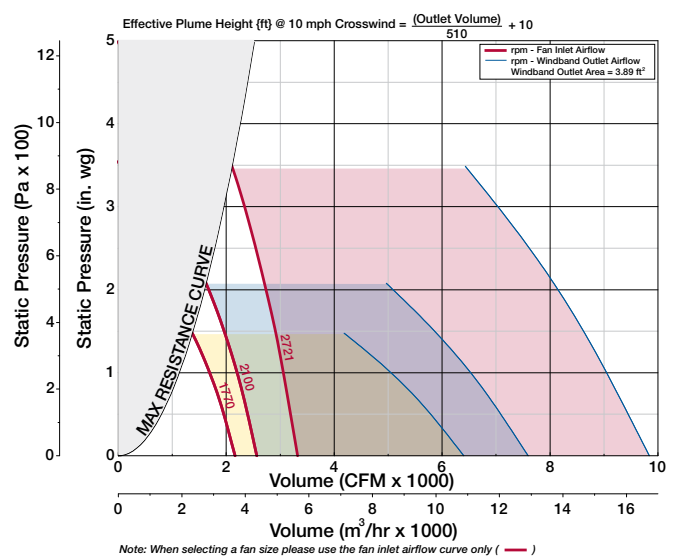
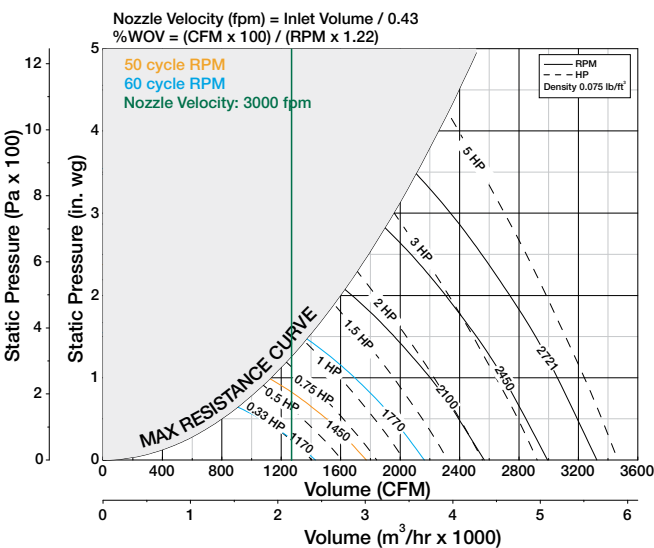

Performance certified is for installation Type A: Free inlet, Free outlet. Power rating (Bhp) does not include transmission losses. Performance ratings do not include the effects of cross winds. Performance ratings do not include the effects of appurtenances (accessories).

85% Wheel Width

Inlet Airflow

Outlet Airflow

AIR DATA

LV
Low Velocity

MV
Medium Velocity

HV
High Velocity

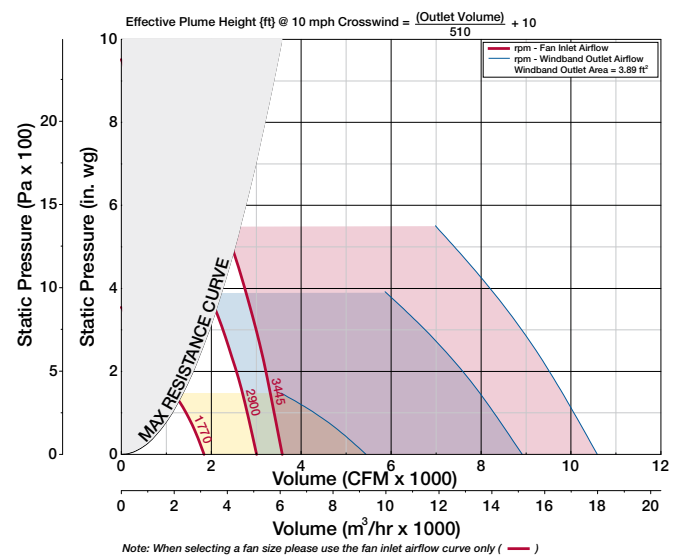
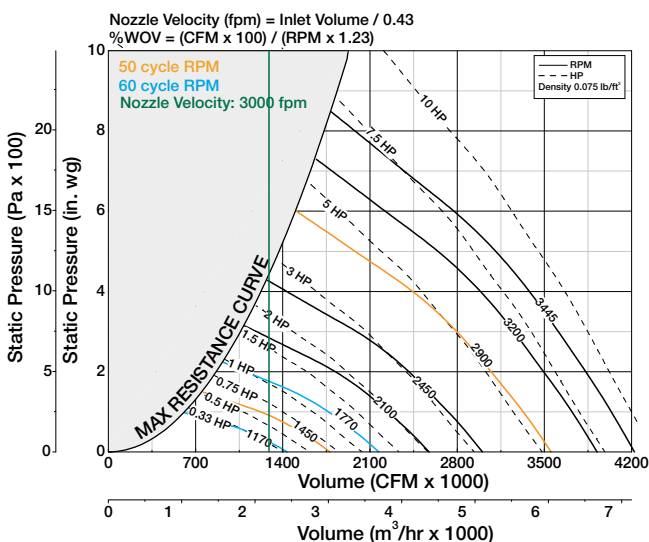
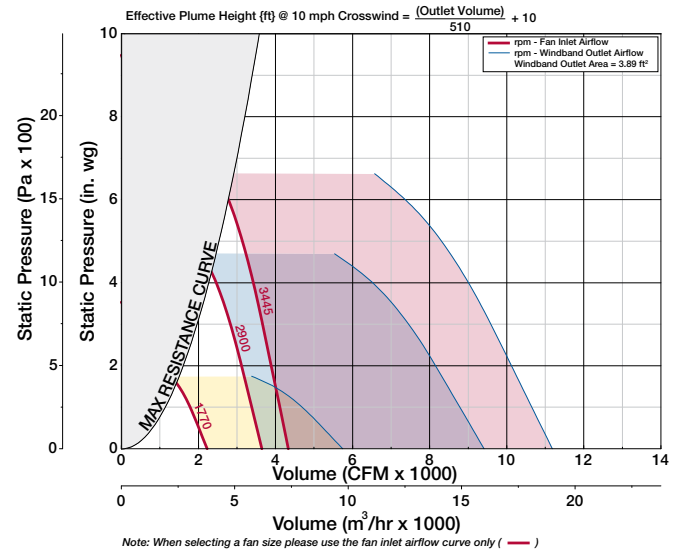
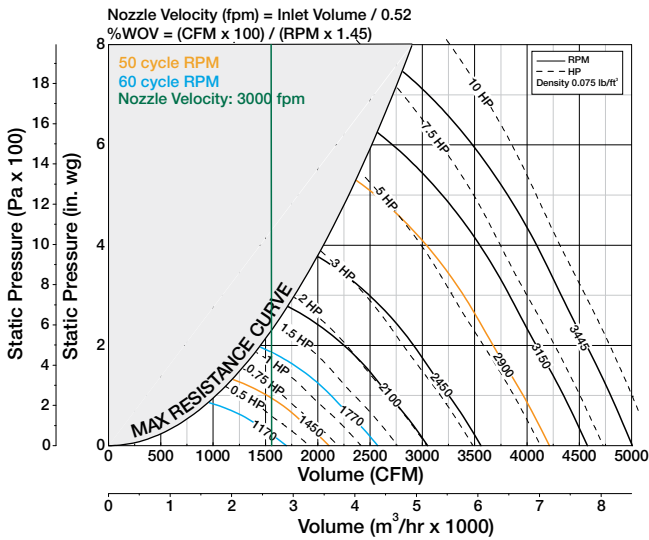
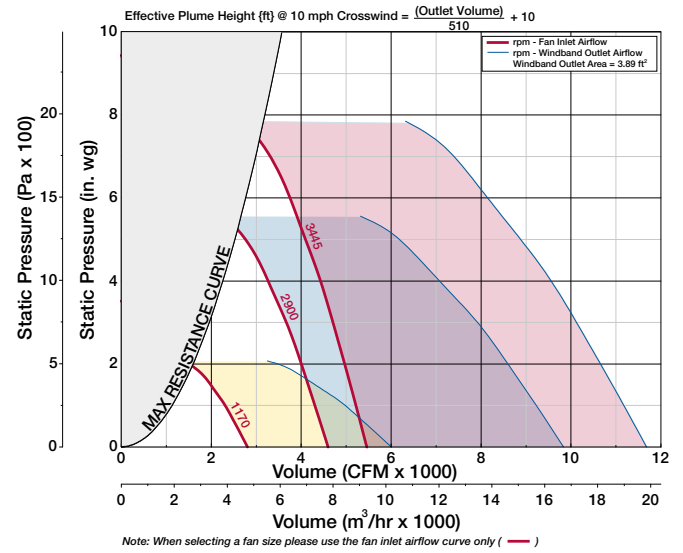
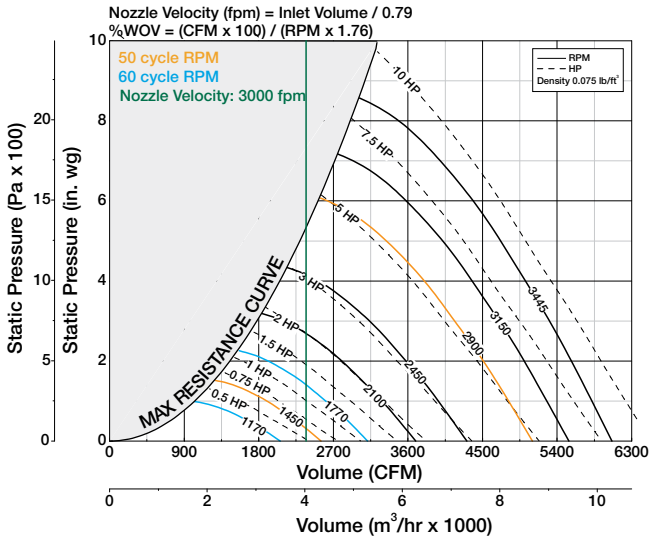

Performance certified is for installation Type A: Free inlet, Free outlet. Power rating (Bhp) does not include transmission losses. Performance ratings do not include the effects of cross winds. Performance ratings do not include the effects of appurtenances (accessories).

AIR DATA

Inlet Airflow

70% Wheel Width

Outlet Airflow

LV
Low Velocity

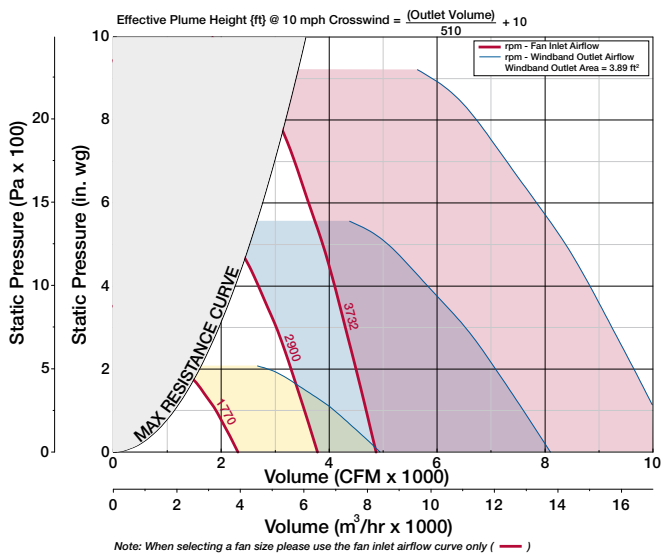
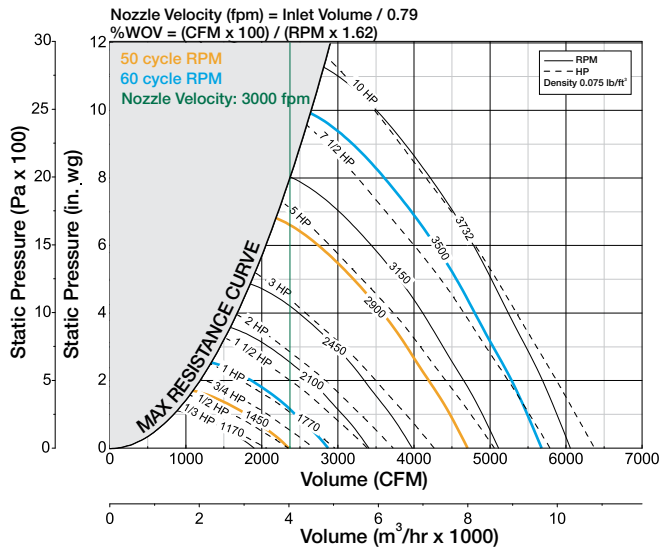

MV
Medium Velocity

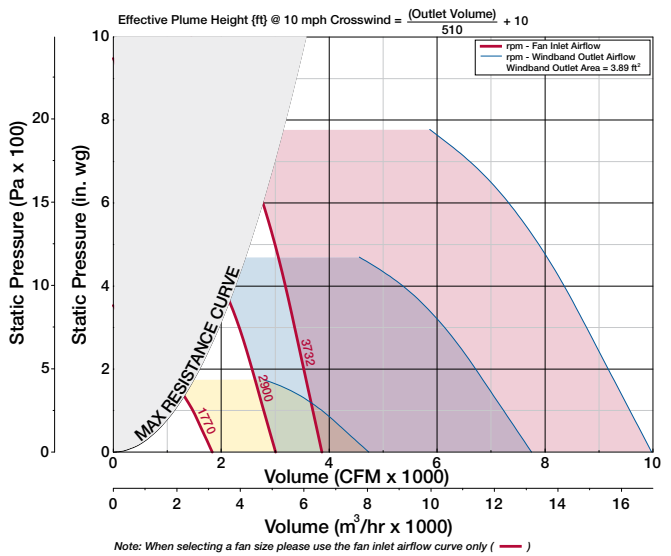
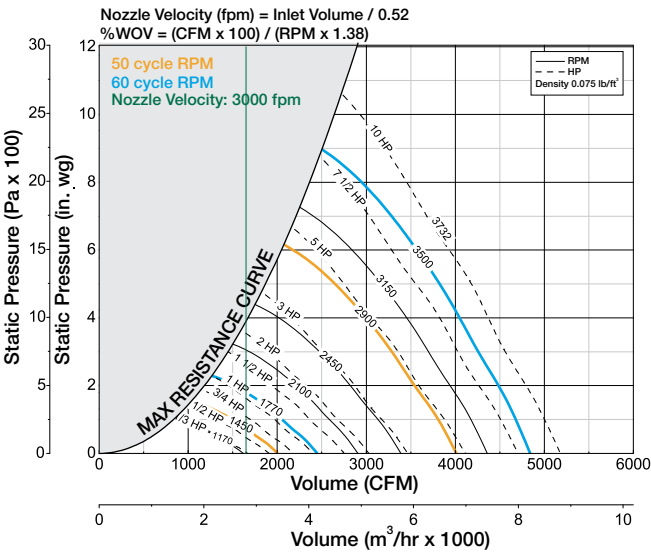

HV
High Velocity

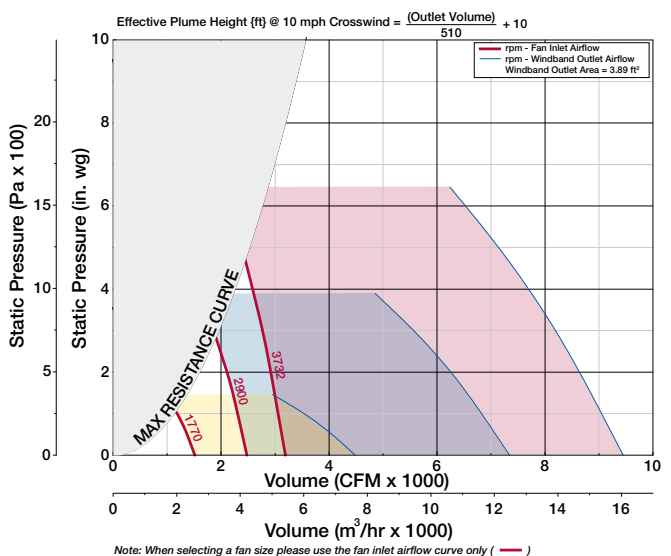
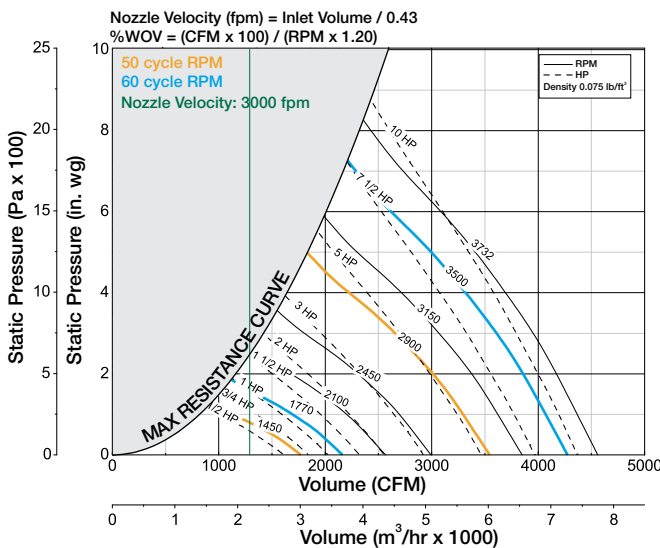

Performance certified is for installation Type A: Free inlet, Free outlet. Power rating (Bhp) does not include transmission losses. Performance ratings do not include the effects of cross winds. Performance ratings do not include the effects of appurtenances (accessories).

Inlet Airflow 50% Wheel Width Outlet Airflow

AIR DATA
LV
Low Velocity

MV
Medium Velocity

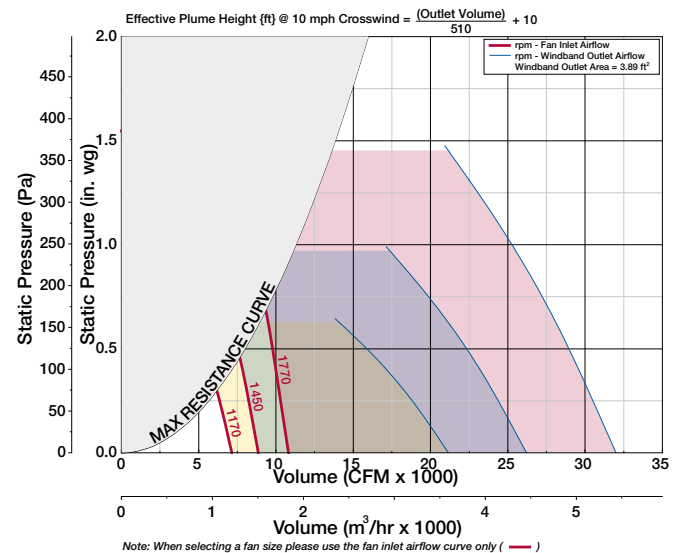
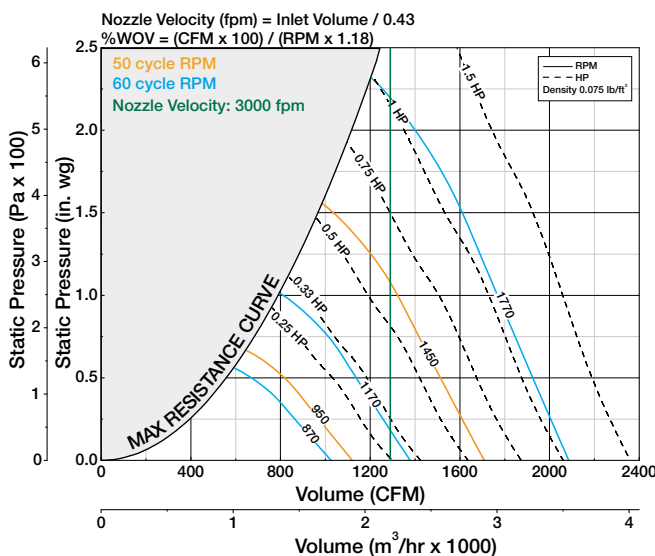
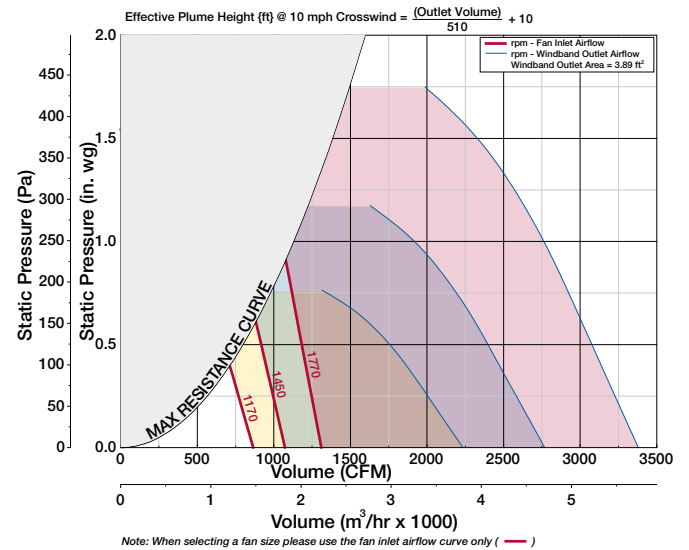
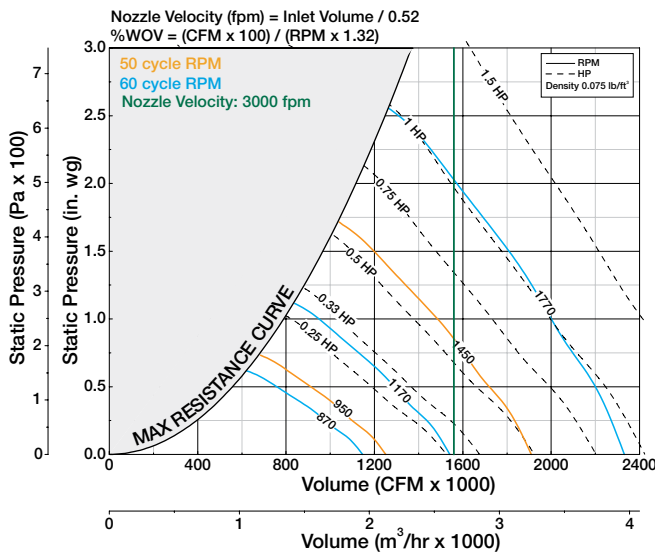
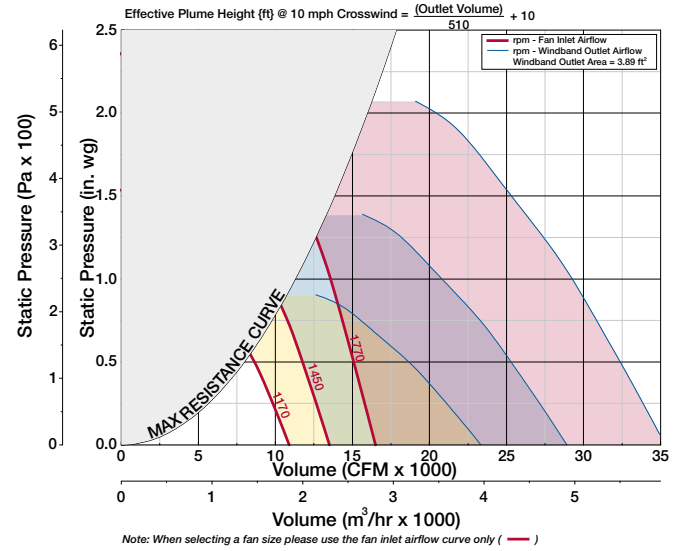
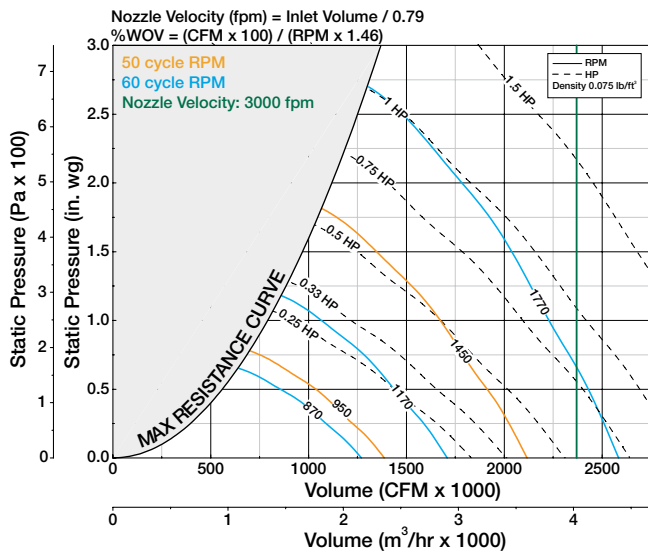
HV
High Velocity

Performance certified is for installation Type A: Free inlet, Free outlet. Power rating (Bhp) does not include transmission losses. Performance ratings do not include the effects of cross winds. Performance ratings do not include the effects of appurtenances (accessories).

Inlet Airflow

100% Wheel Width

Outlet Airflow

LV
Low Velocity

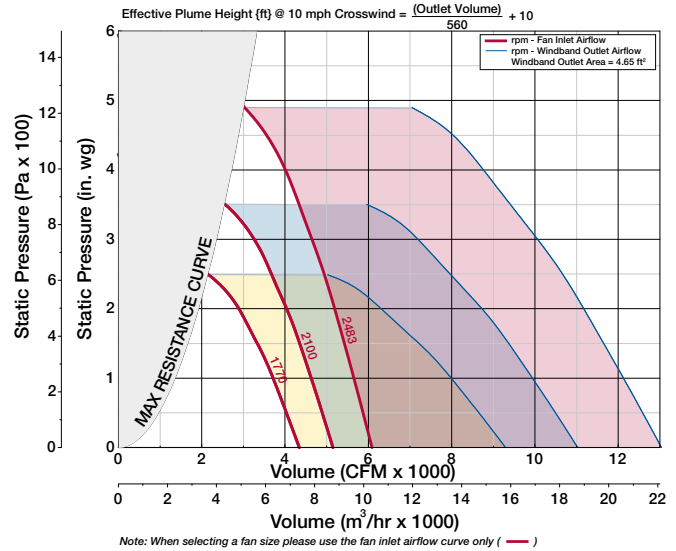
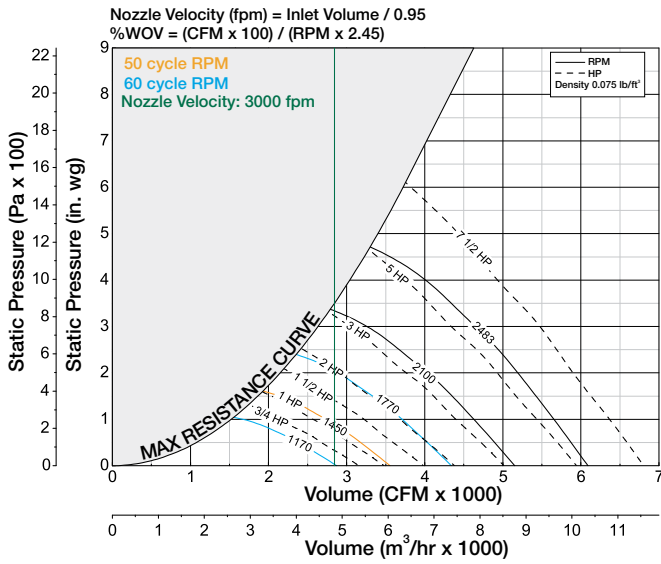

MV
Medium Velocity

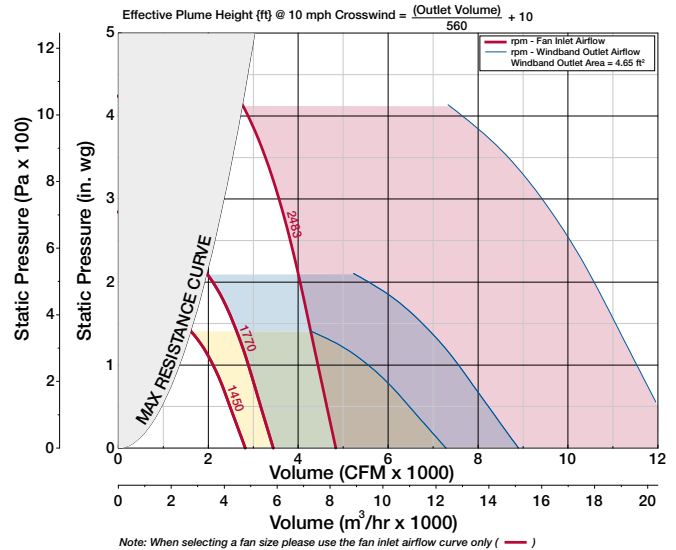
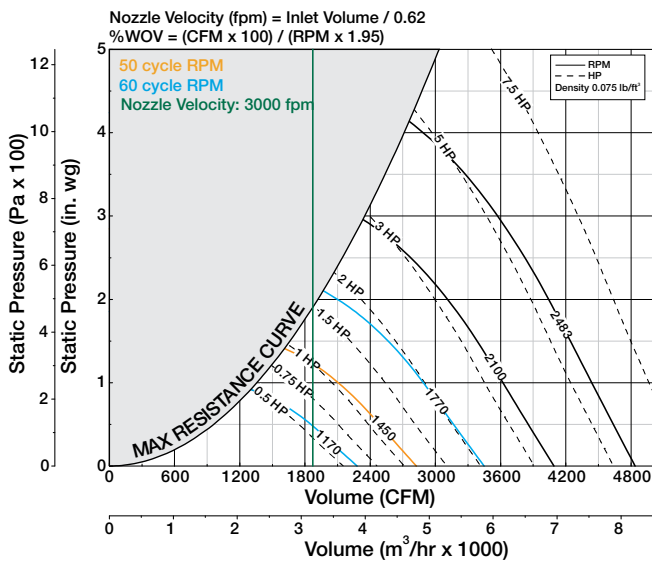

HV
High Velocity

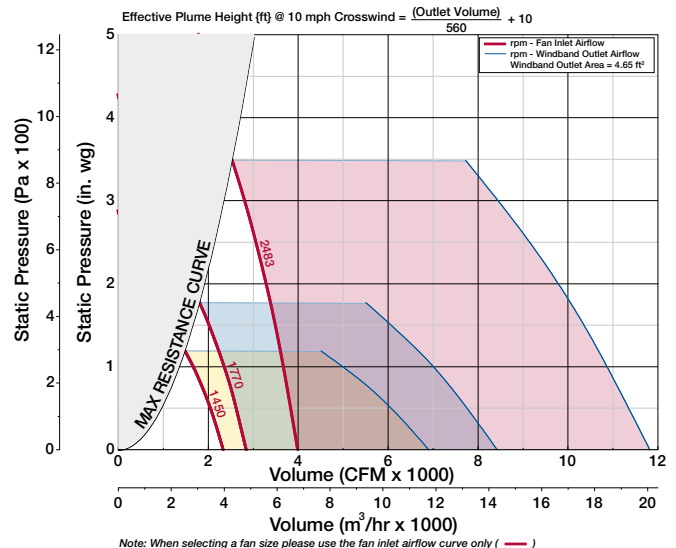
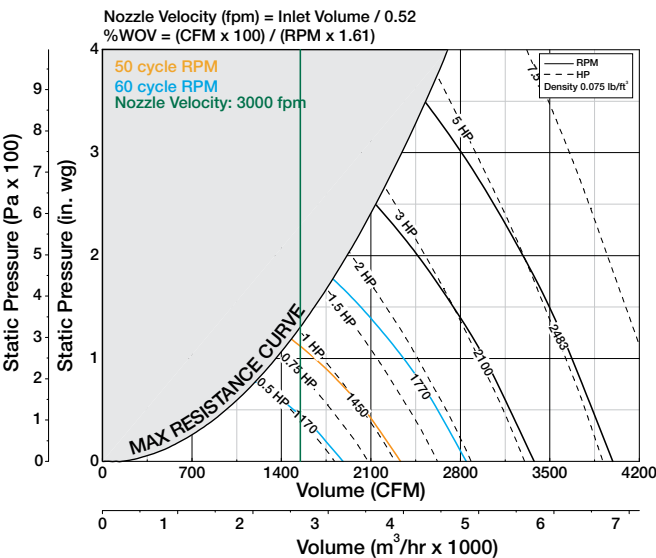

Performance certified is for installation Type A: Free inlet, Free outlet. Power rating (Bhp) does not include transmission losses. Performance ratings do not include the effects of cross winds. Performance ratings do not include the effects of appurtenances (accessories).

Inlet Airflow

85% Wheel Width

Outlet Airflow

AIR DATA

LV
Low Velocity

MV
Medium Velocity

HV
High Velocity

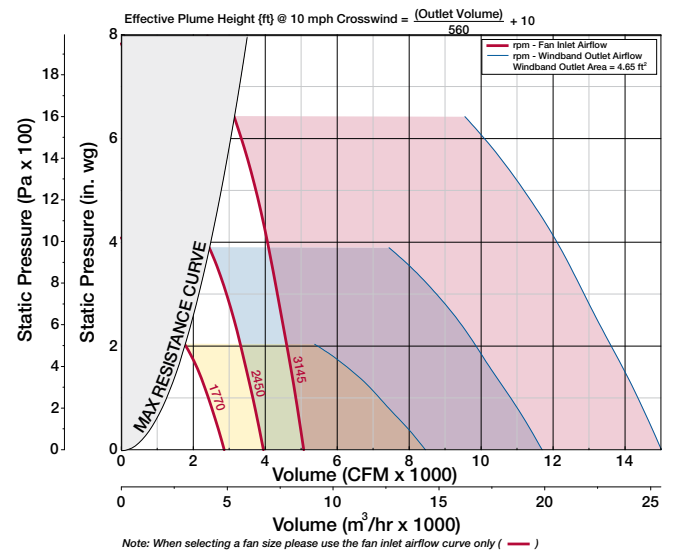
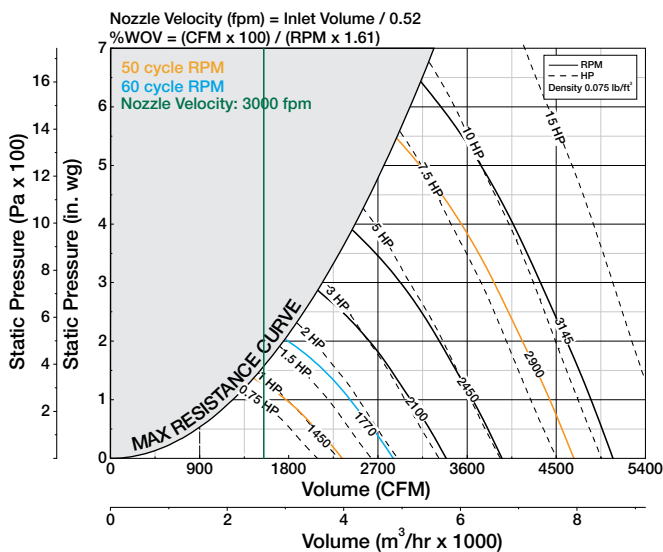
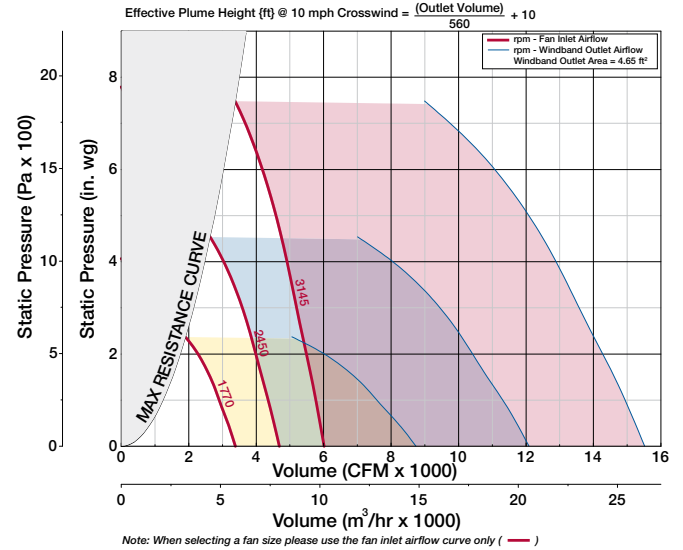
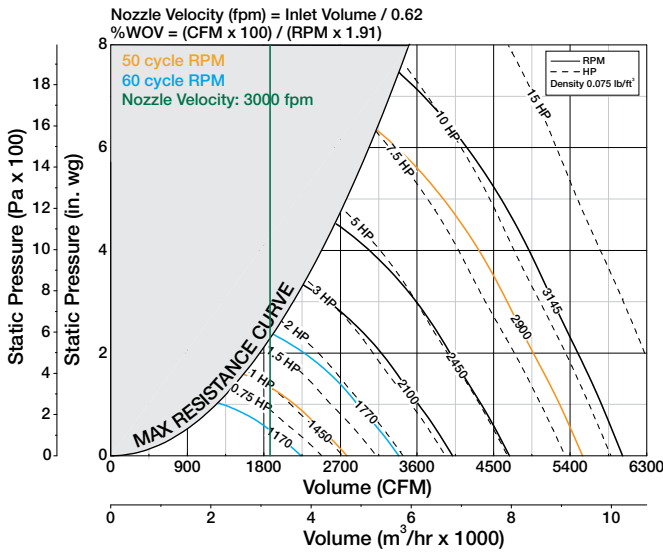
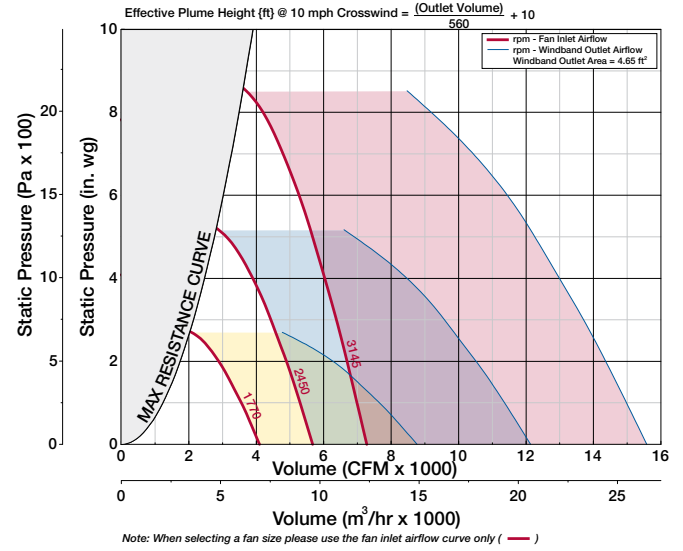
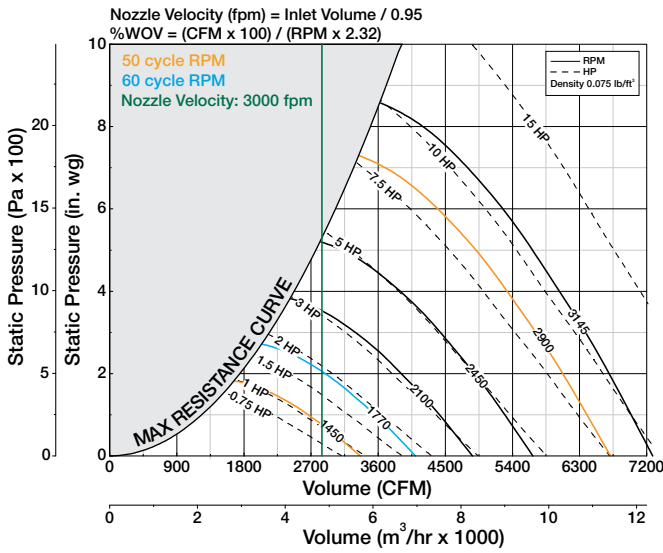

Performance certified is for installation Type A: Free inlet, Free outlet. Power rating (Bhp) does not include transmission losses. Performance ratings do not include the effects of cross winds. Performance ratings do not include the effects of appurtenances (accessories).

AIR DATA

Inlet Airflow

70% Wheel Width

Outlet Airflow

LV
Low Velocity

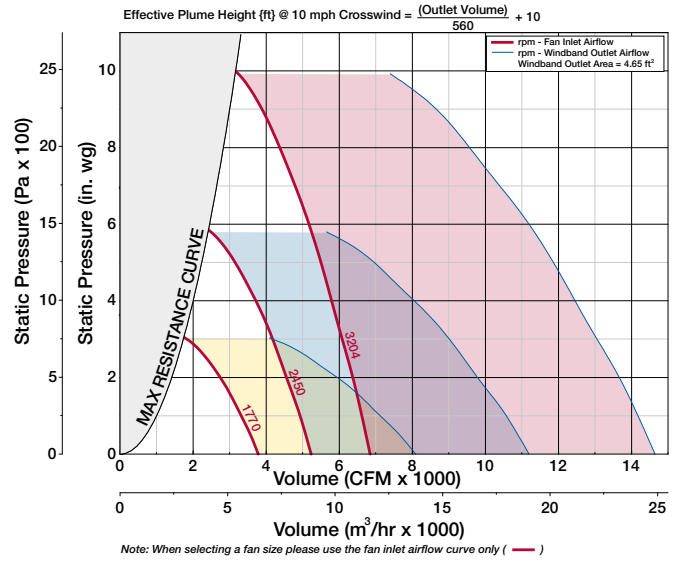
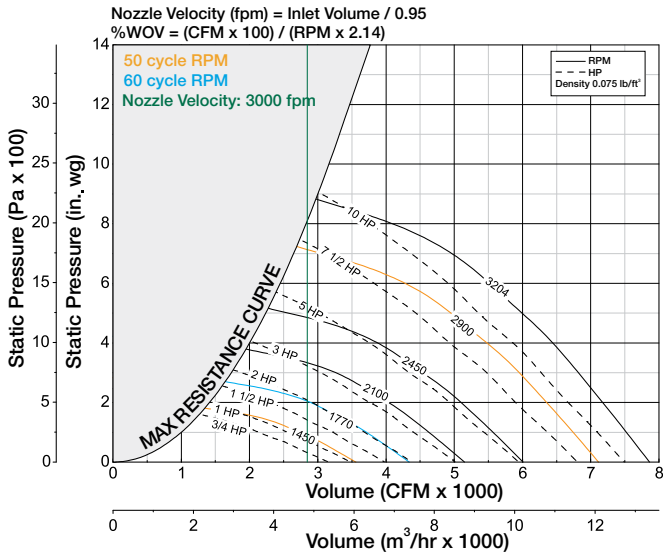

MV
Medium Velocity

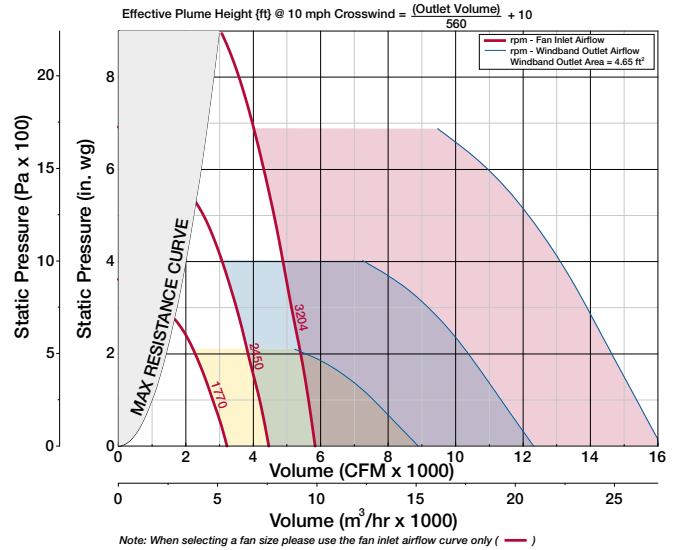
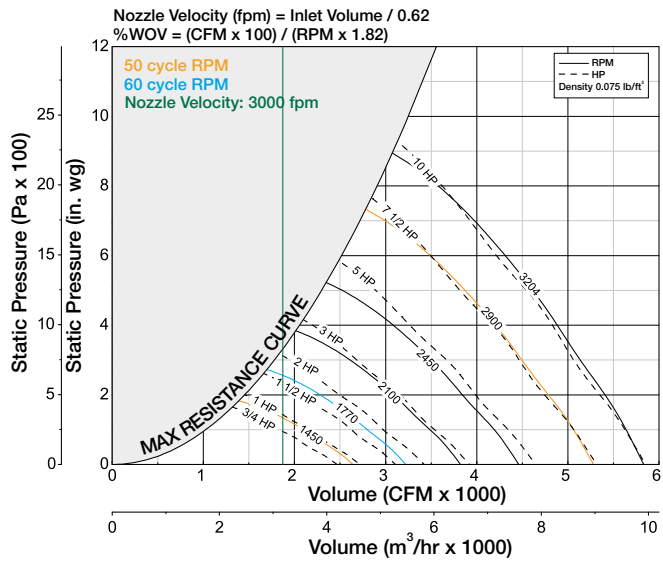

HV
High Velocity

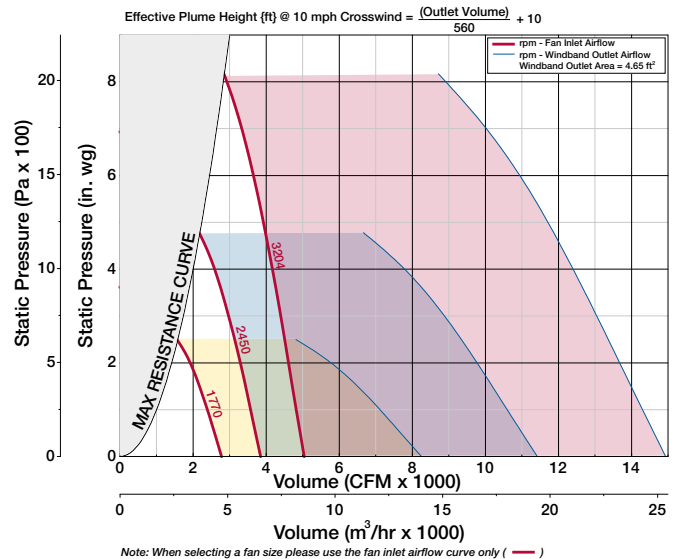
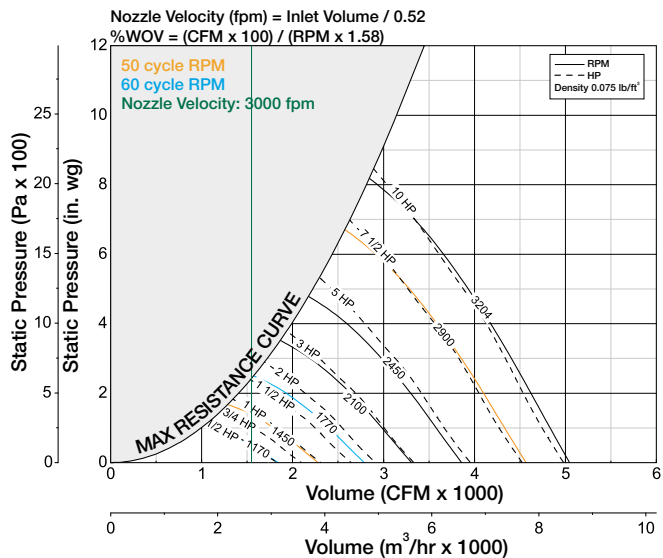

Performance certified is for installation Type A: Free inlet, Free outlet. Power rating (Bhp) does not include transmission losses. Performance ratings do not include the effects of cross winds. Performance ratings do not include the effects of appurtenances (accessories).

Inlet Airflow

50% Wheel Width

Outlet Airflow

AIR DATA

LV
Low Velocity

MV
Medium Velocity

HV
High Velocity

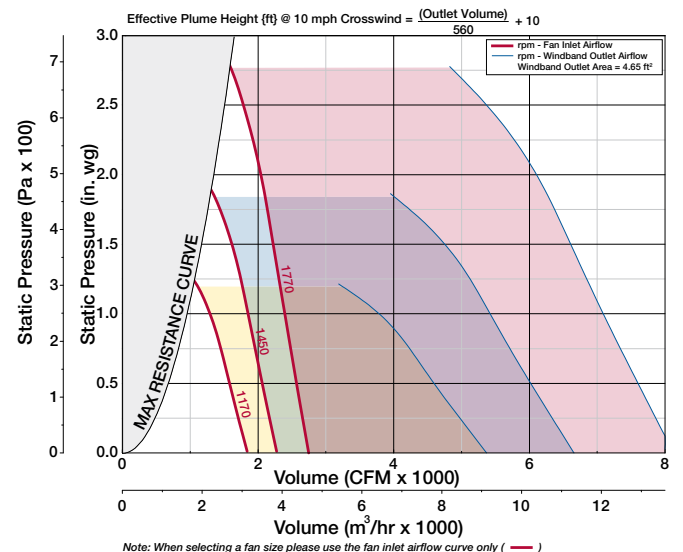
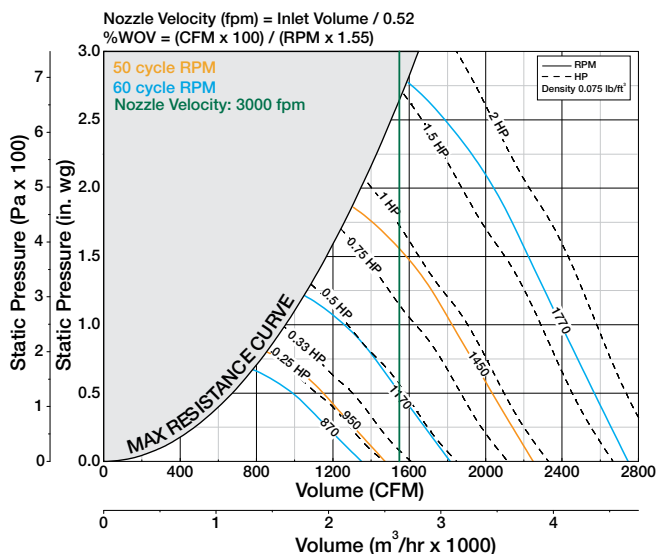
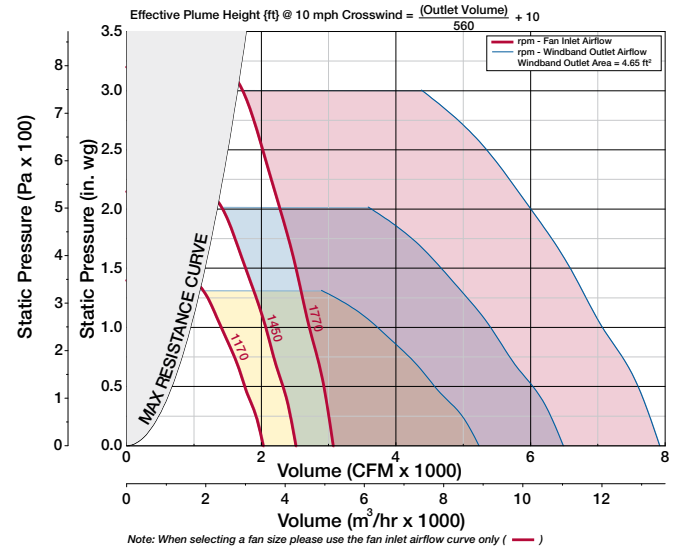
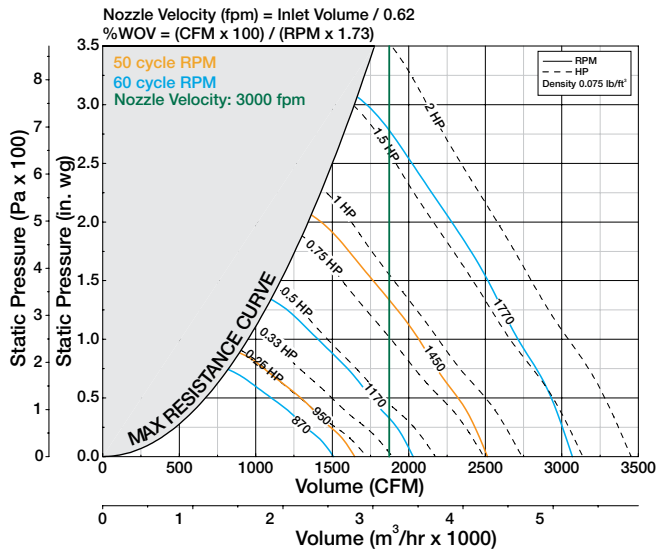
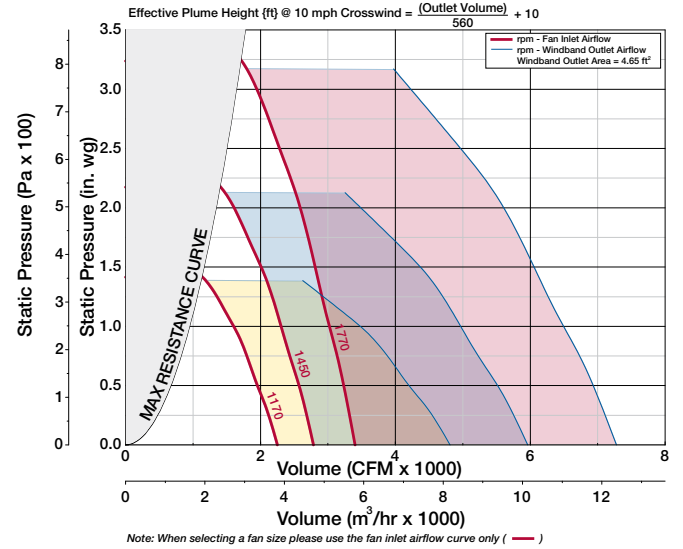
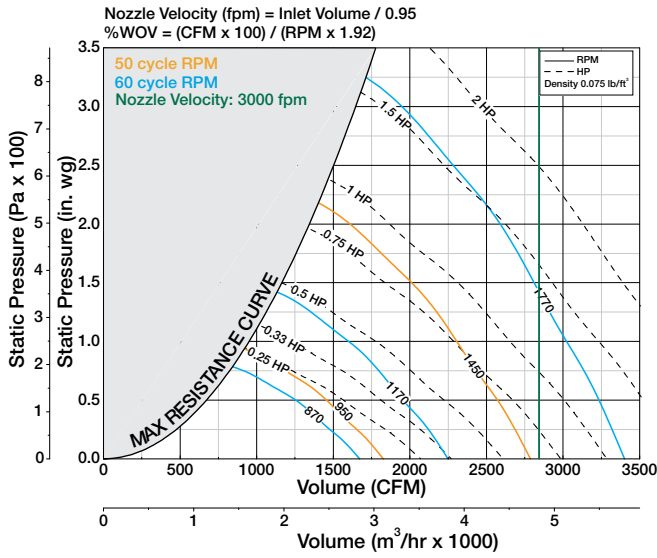

Performance certified is for installation Type A: Free inlet, Free outlet. Power rating (Bhp) does not include transmission losses. Performance ratings do not include the effects of cross winds. Performance ratings do not include the effects of appurtenances (accessories).

Inlet Airflow

100% Wheel Width

Outlet Airflow

AIR DATA

LV
Low Velocity

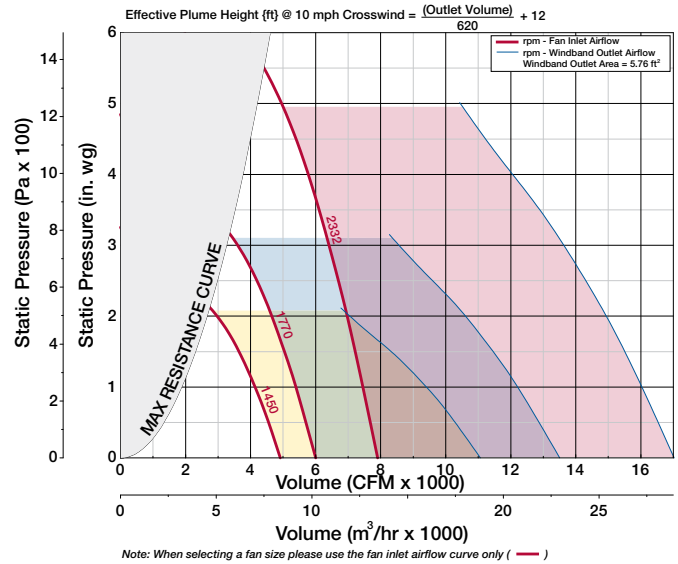
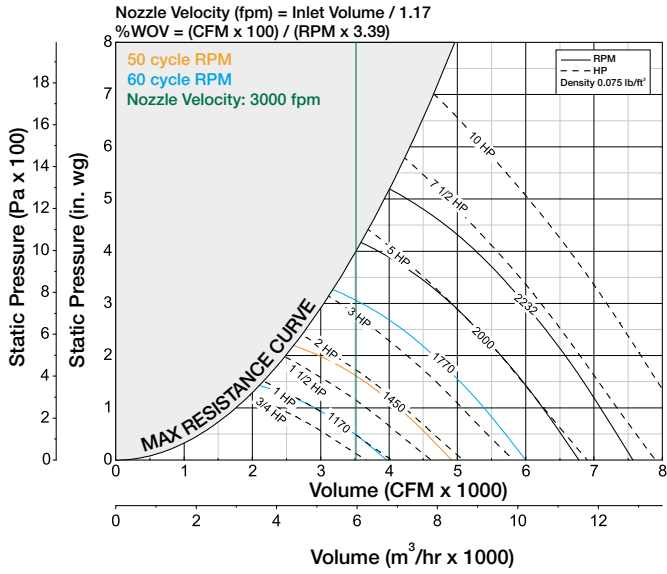

MV
Medium Velocity

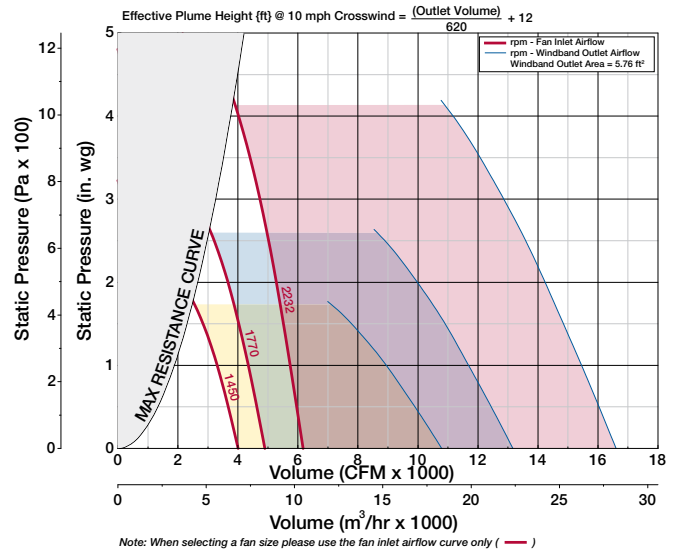
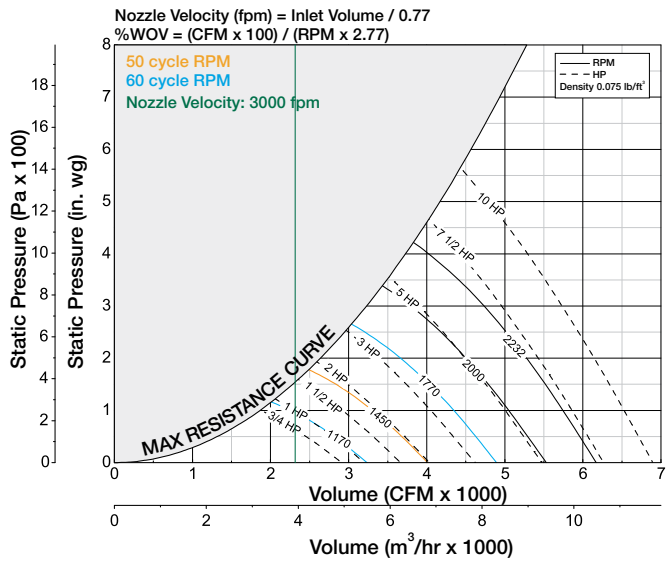

HV
High Velocity

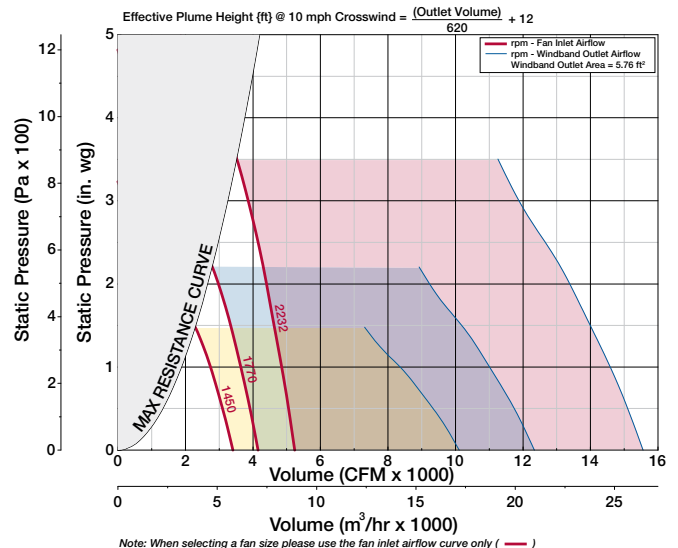
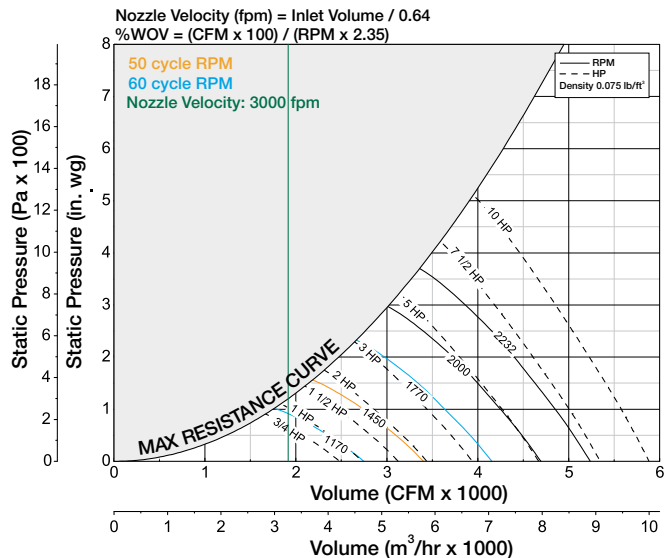

Performance certified is for installation Type A: Free inlet, Free outlet. Power rating (Bhp) does not include transmission losses. Performance ratings do not include the effects of cross winds. Performance ratings do not include the effects of appurtenances (accessories).

Inlet Airflow

85% Wheel Width

Outlet Airflow

AIR DATA

LV
Low Velocity

MV
Medium Velocity

HV
High Velocity

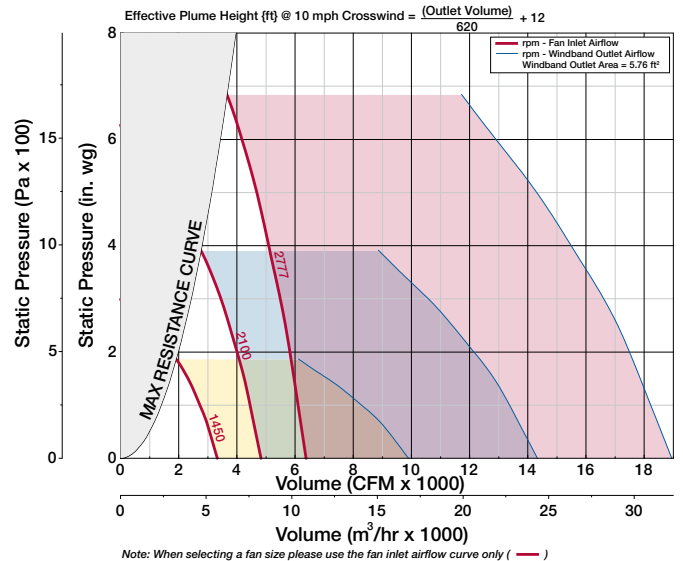
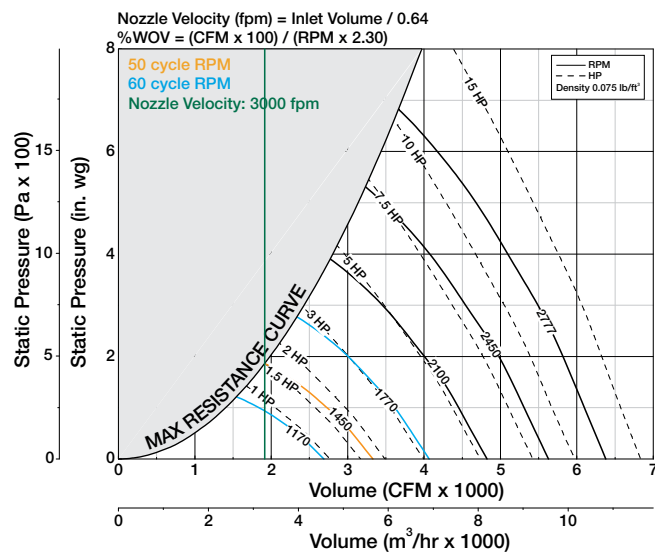
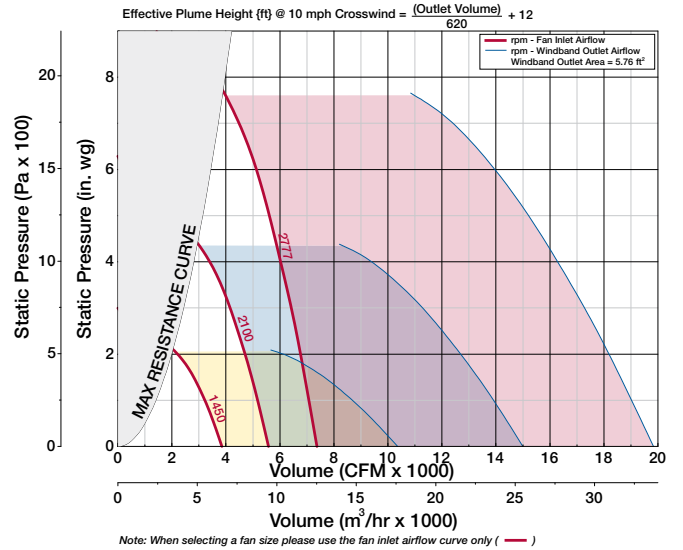
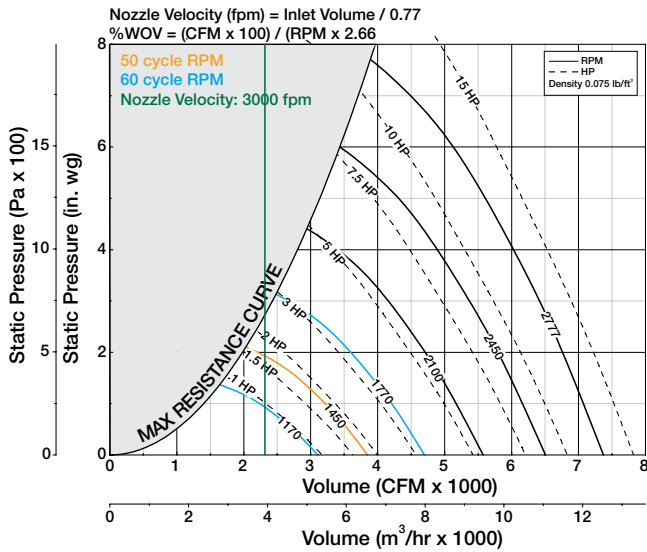
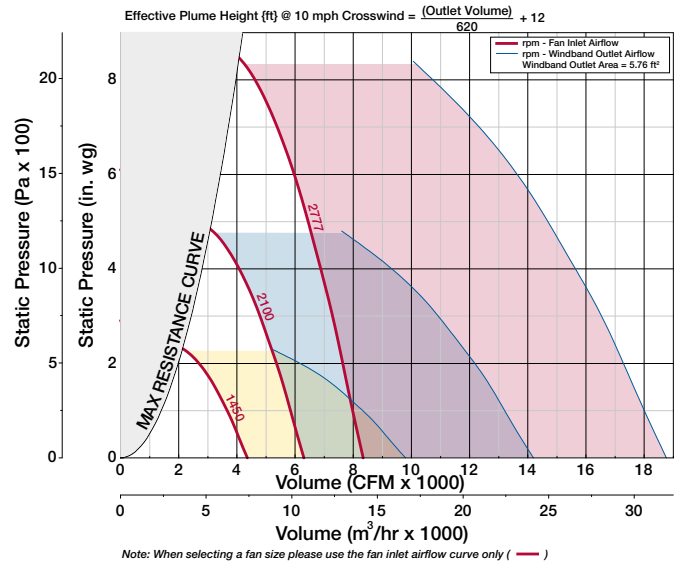
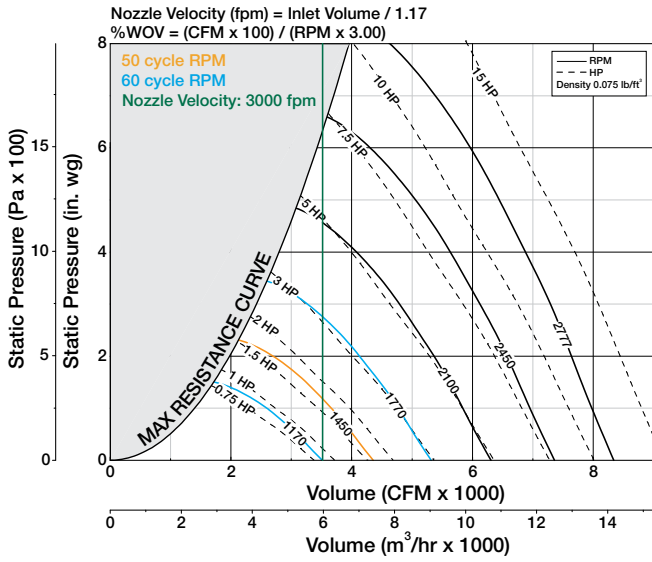

Performance certified is for installation Type A: Free inlet, Free outlet. Power rating (Bhp) does not include transmission losses. Performance ratings do not include the effects of cross winds. Performance ratings do not include the effects of appurtenances (accessories).

AIR DATA

Inlet Airflow

70% Wheel Width

Outlet Airflow

LV
Low Velocity

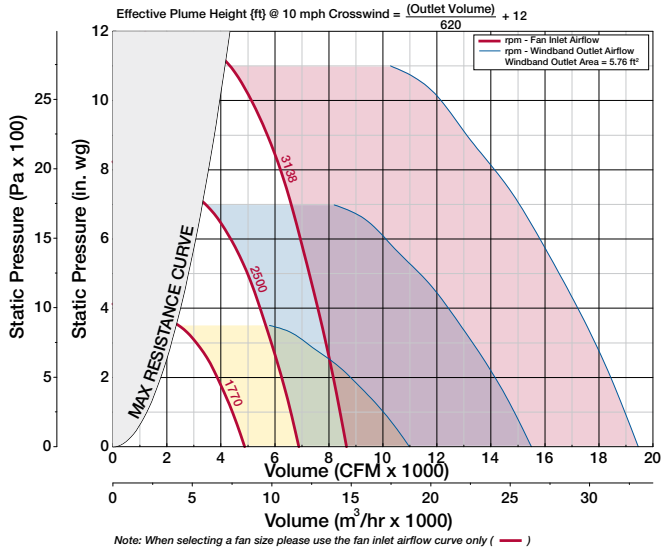
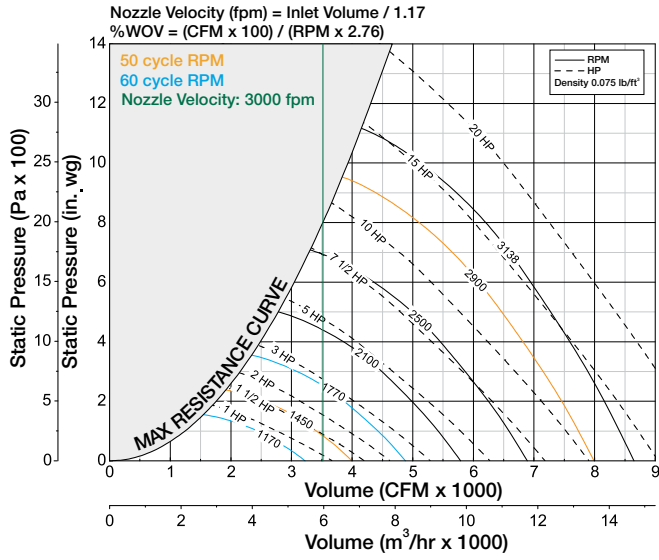

MV
Medium Velocity

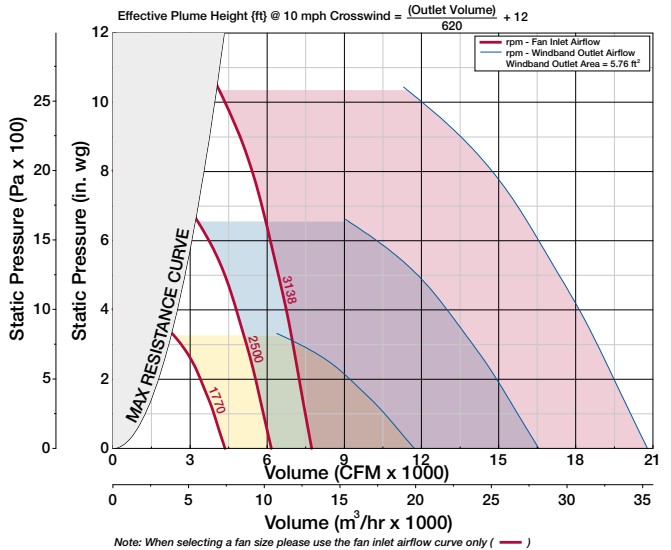
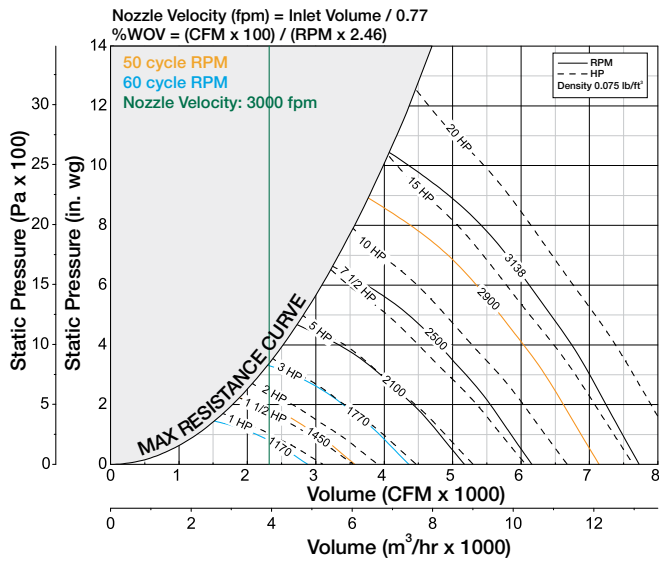

HV
High Velocity

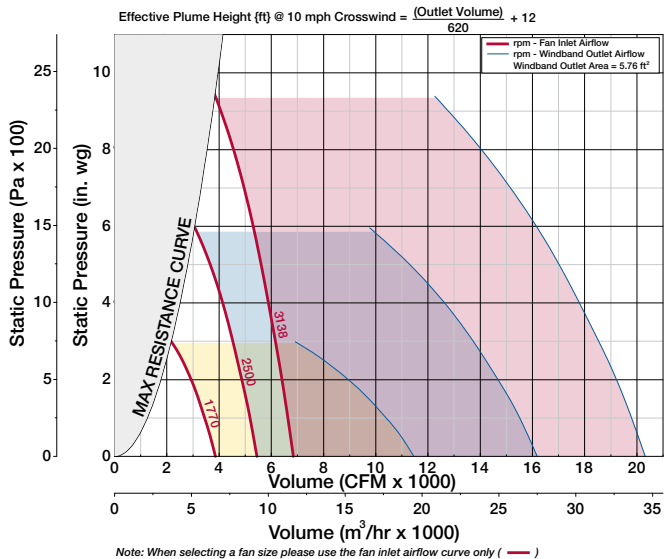
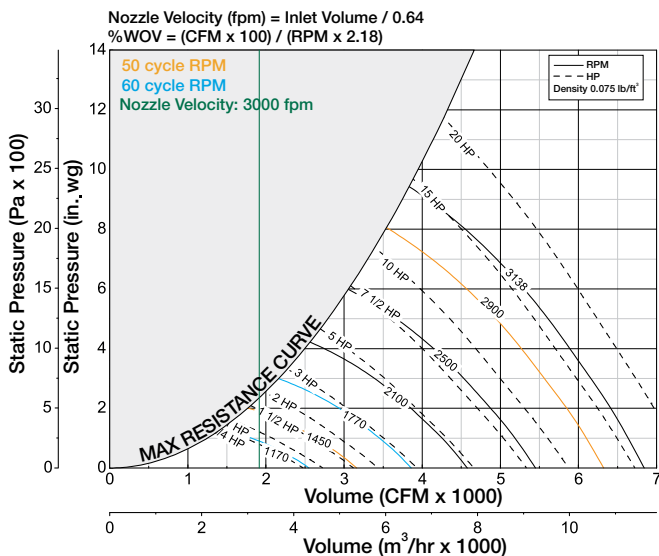

Performance certified is for installation Type A: Free inlet, Free outlet. Power rating (Bhp) does not include transmission losses. Performance ratings do not include the effects of cross winds. Performance ratings do not include the effects of appurtenances (accessories).

Inlet Airflow

50% Wheel Width

Outlet Airflow

AIR DATA

LV
Low Velocity

MV
Medium Velocity

HV
High Velocity

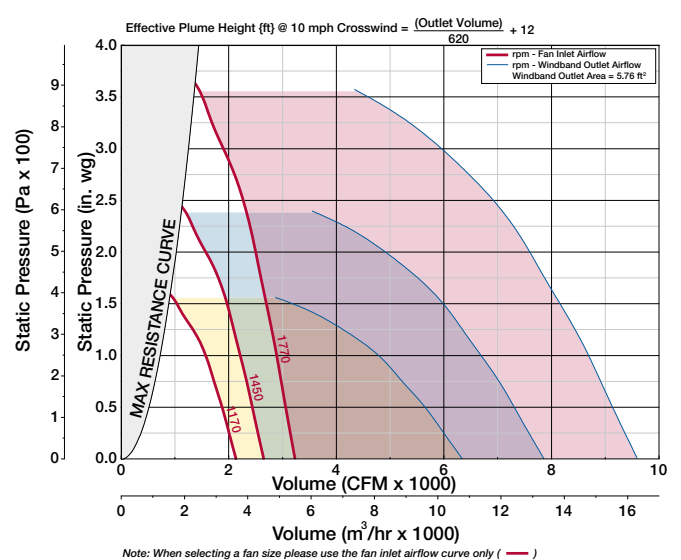
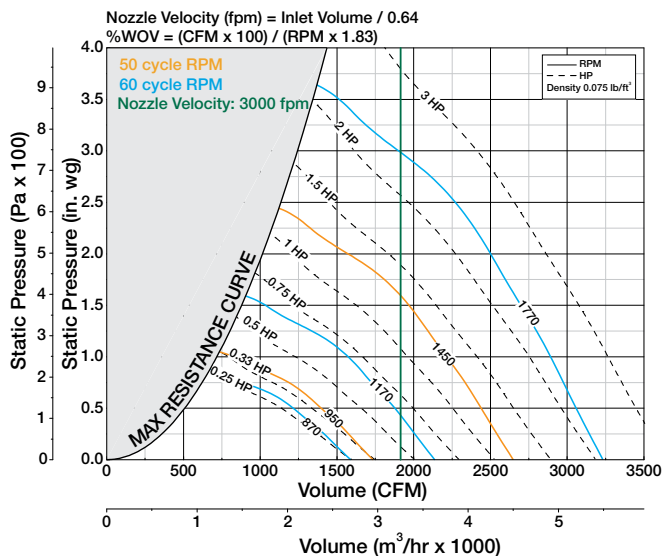
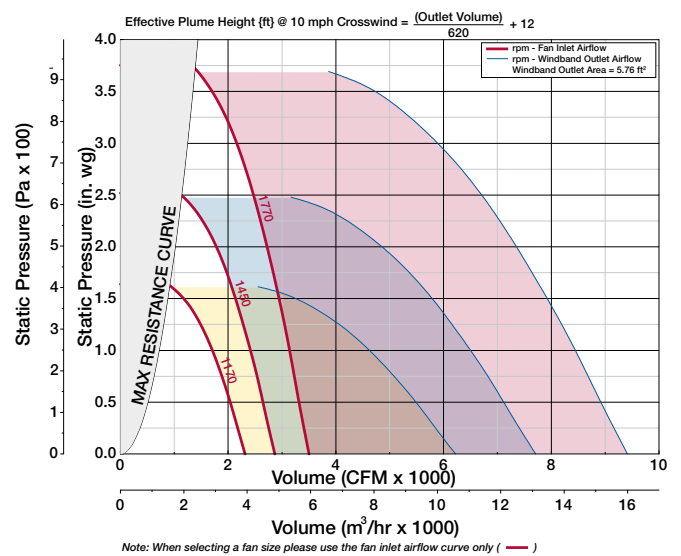
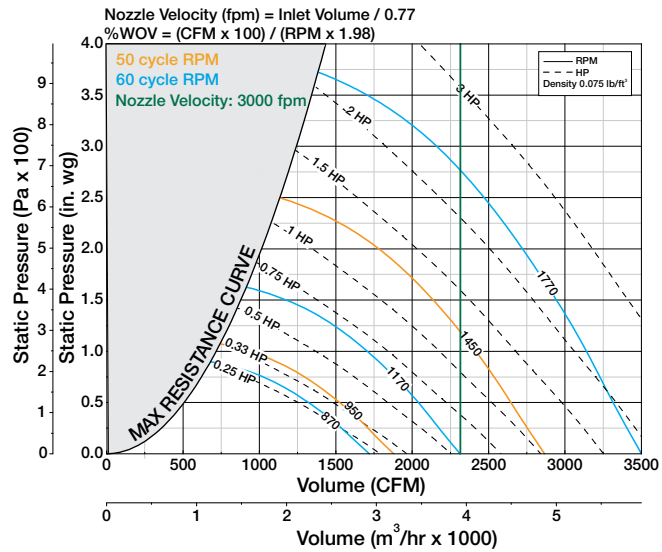
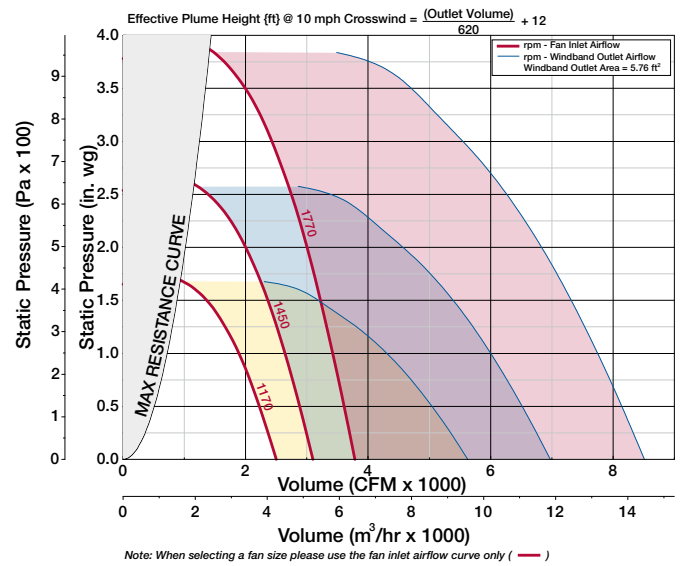
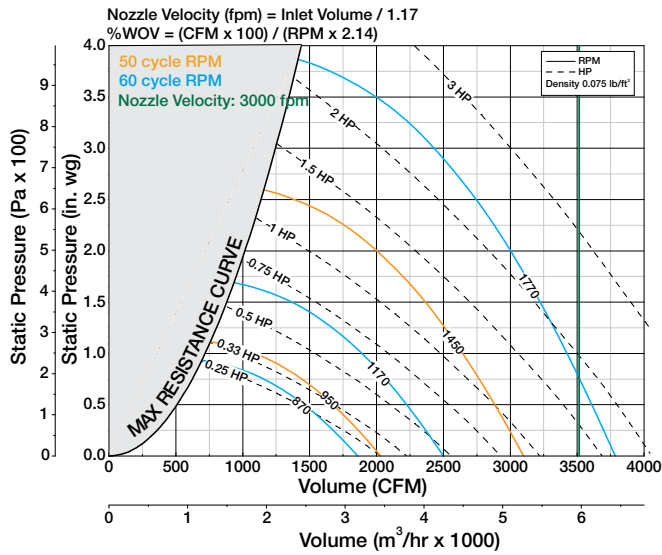

Performance certified is for installation Type A: Free inlet, Free outlet. Power rating (Bhp) does not include transmission losses. Performance ratings do not include the effects of cross winds. Performance ratings do not include the effects of appurtenances (accessories).

AIR DATA

Inlet Airflow

100% Wheel Width

Outlet Airflow

LV
Low Velocity

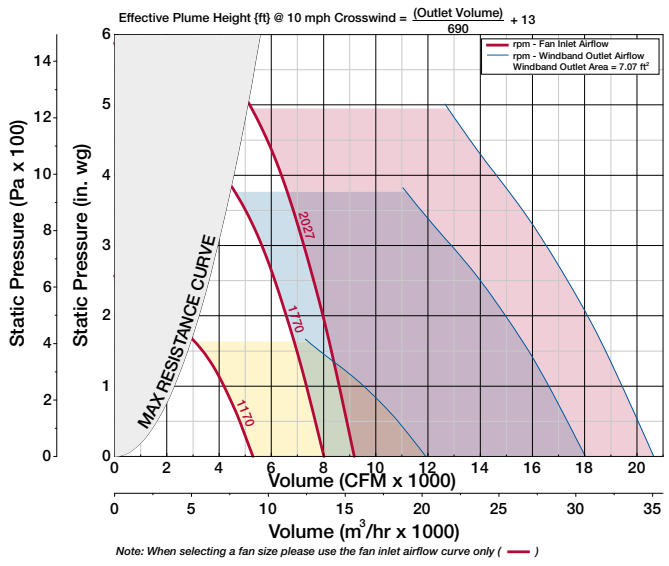
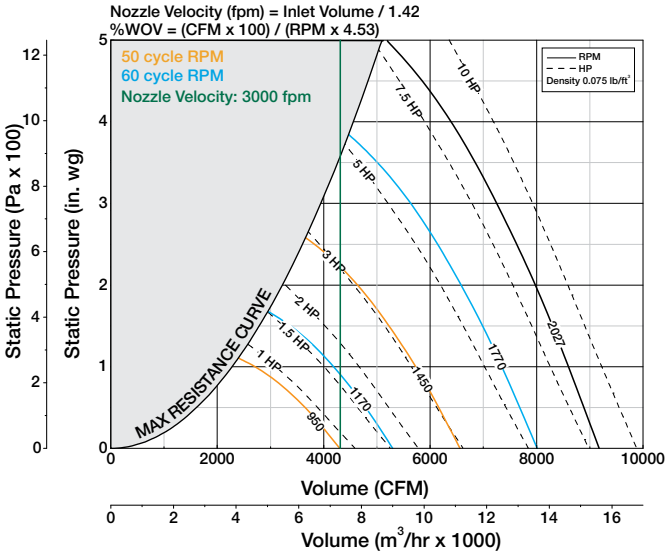

MV
Medium Velocity

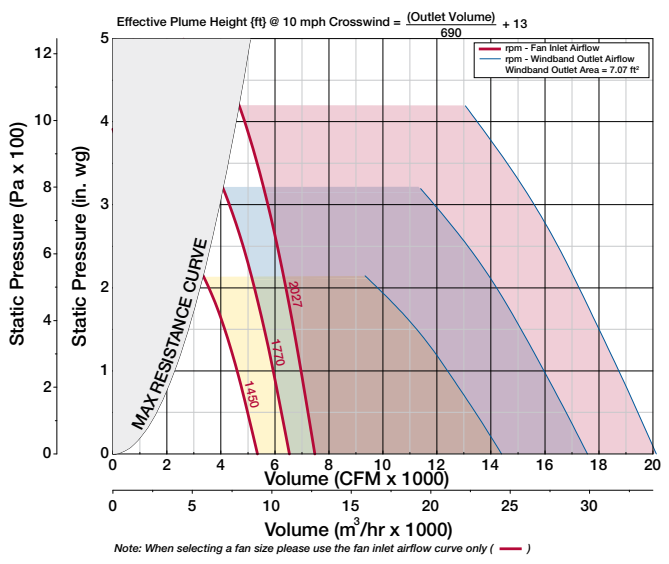
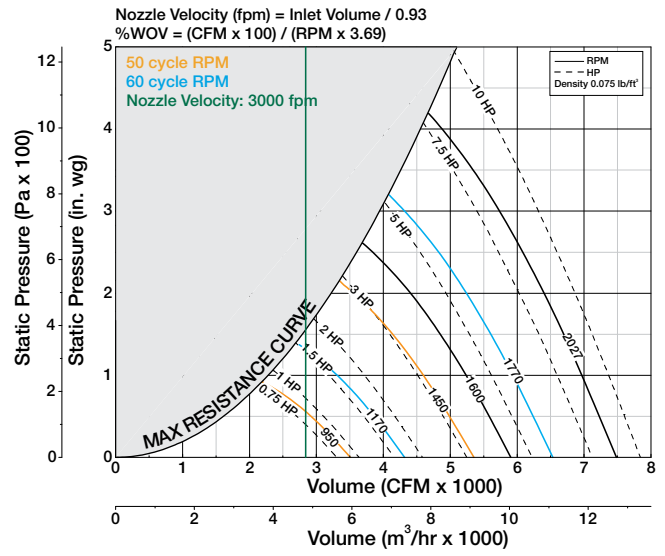

HV
High Velocity

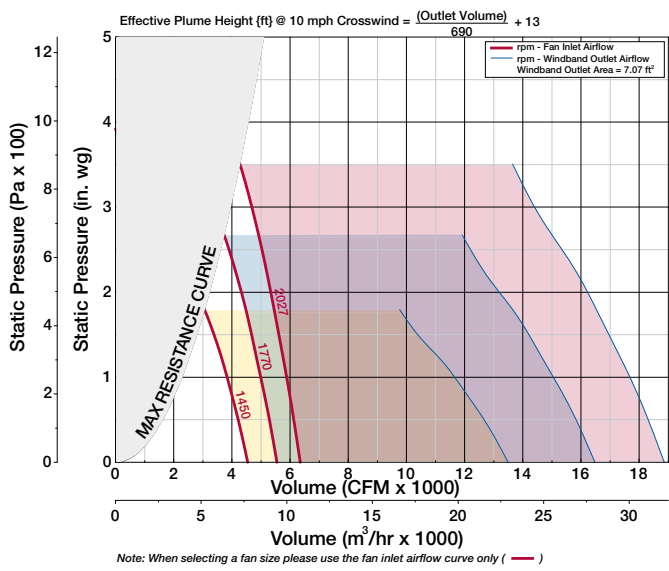
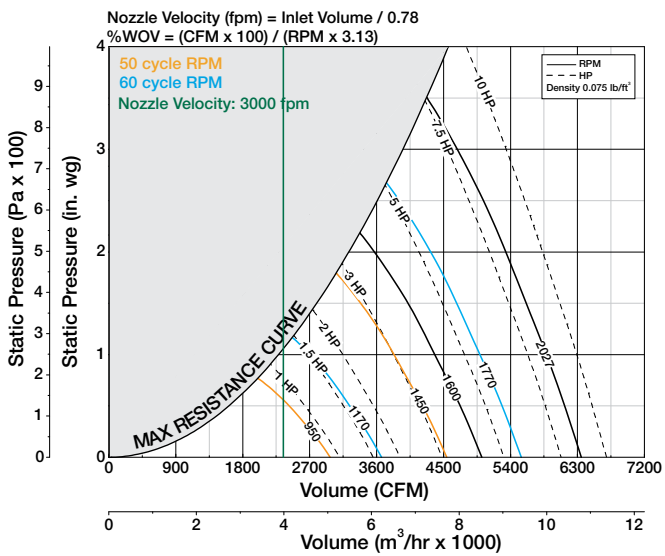

Performance certified is for installation Type A: Free inlet, Free outlet. Power rating (Bhp) does not include transmission losses. Performance ratings do not include the effects of cross winds. Performance ratings do not include the effects of appurtenances (accessories).

Inlet Airflow

85% Wheel Width

Outlet Airflow

AIR DATA

Low Velocity
LV

Medium Velocity
MV

High Velocity
HV

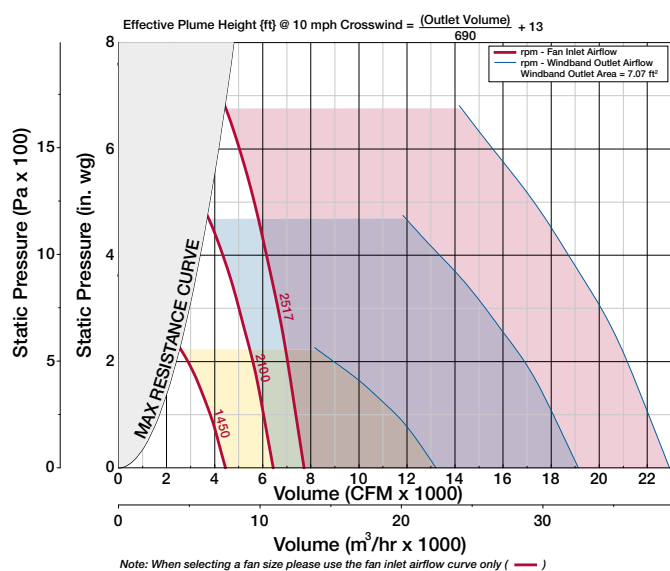
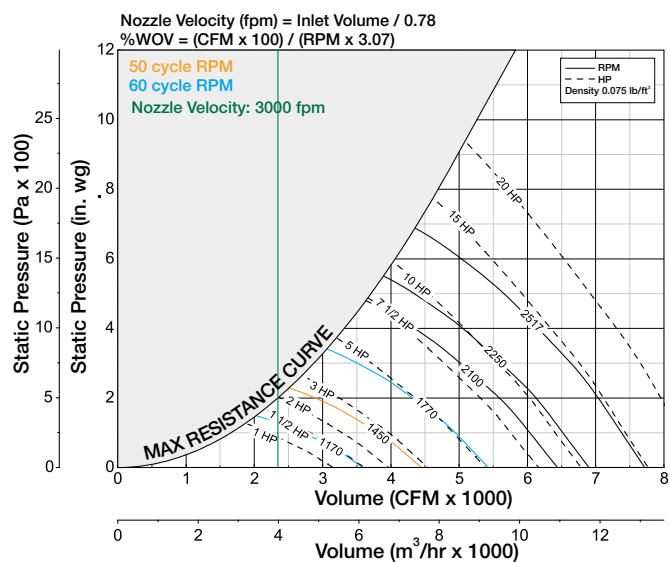
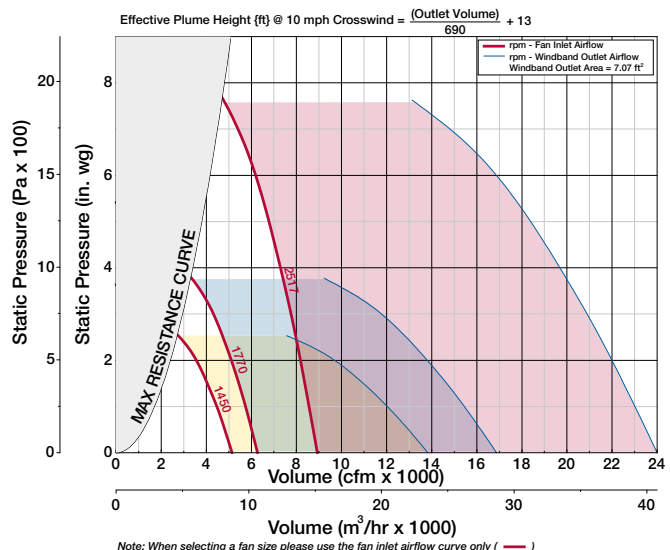
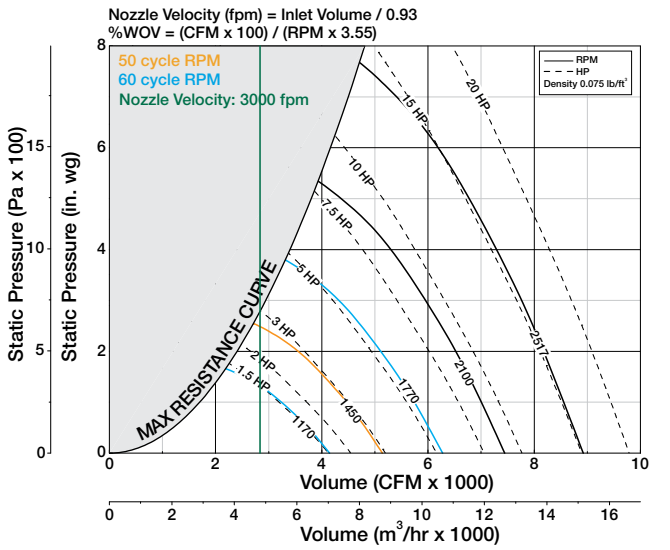
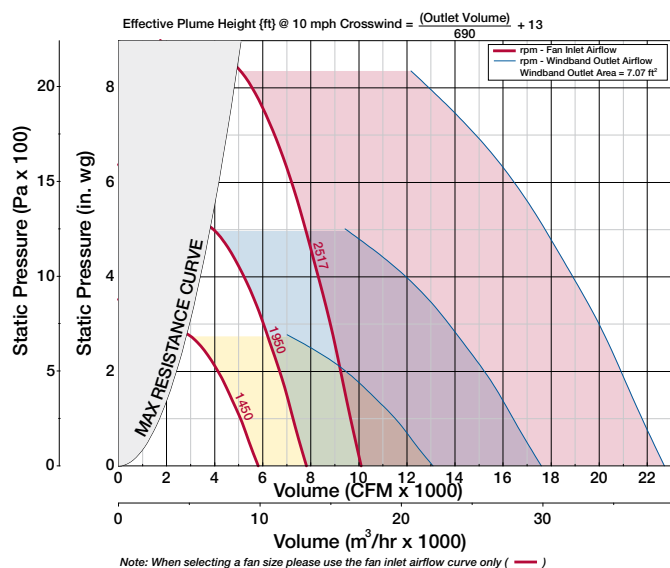
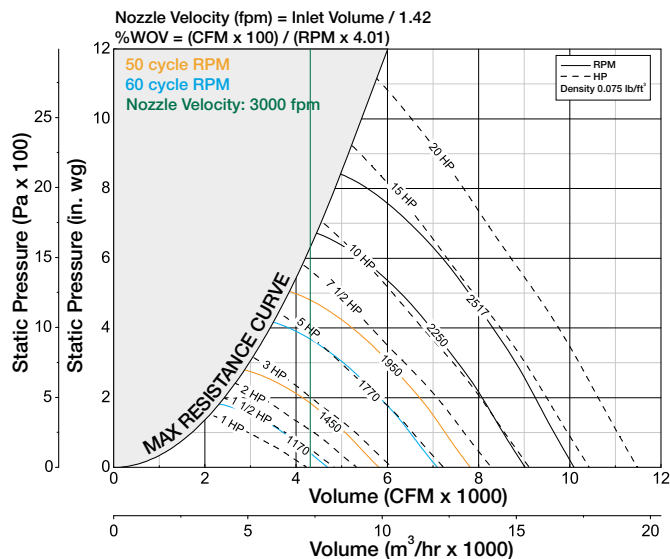

Performance certified is for installation Type A: Free inlet, Free outlet. Power rating (Bhp) does not include transmission losses. Performance ratings do not include the effects of cross winds. Performance ratings do not include the effects of appurtenances (accessories).

AIR DATA

Inlet Airflow

70% Wheel Width

Outlet Airflow

LV
Low Velocity

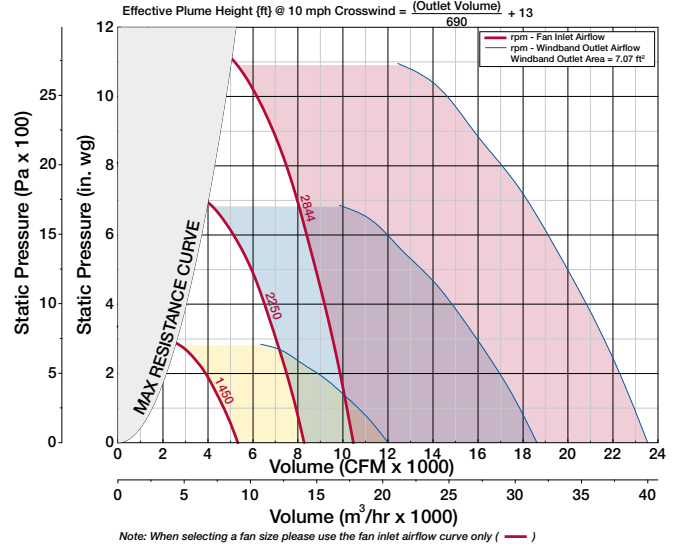
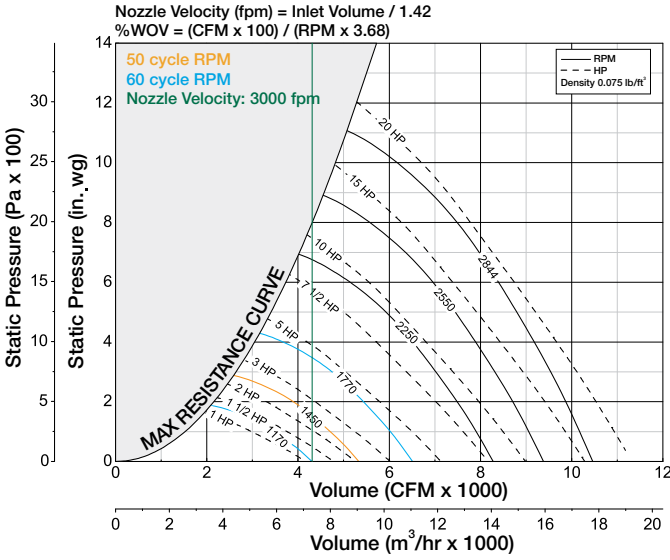

MV
Medium Velocity

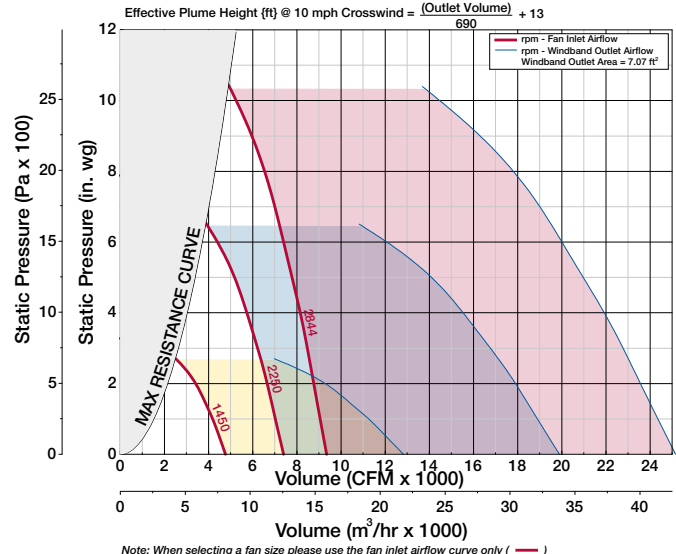
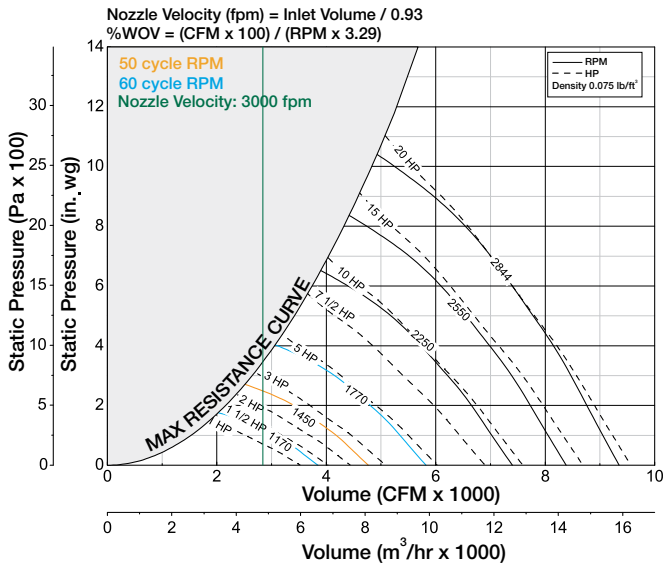

HV
High Velocity

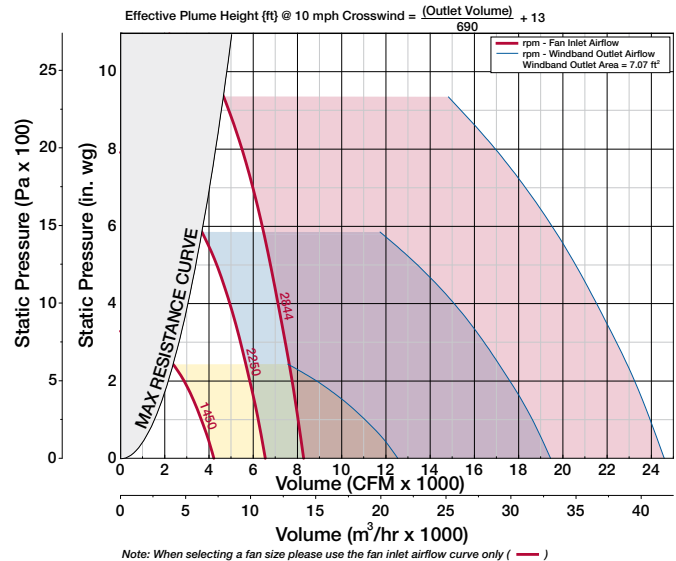
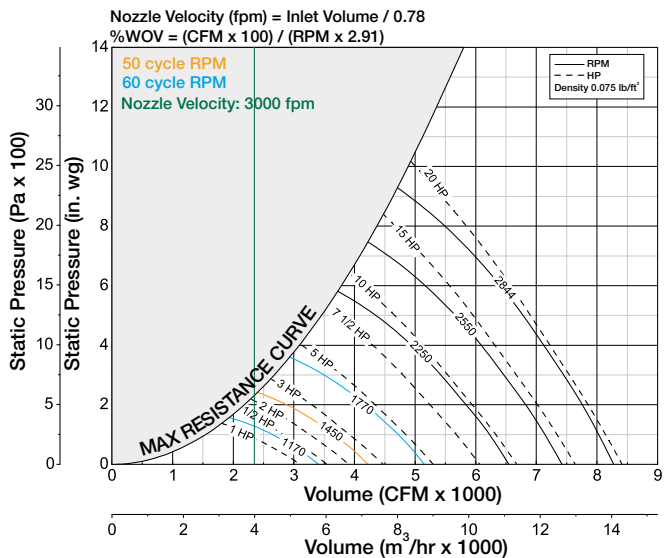

Performance certified is for installation Type A: Free inlet, Free outlet. Power rating (Bhp) does not include transmission losses. Performance ratings do not include the effects of cross winds. Performance ratings do not include the effects of appurtenances (accessories).

Inlet Airflow 50% Wheel Width Outlet Airflow

AIR DATA
LV
Low Velocity

MV
Medium Velocity

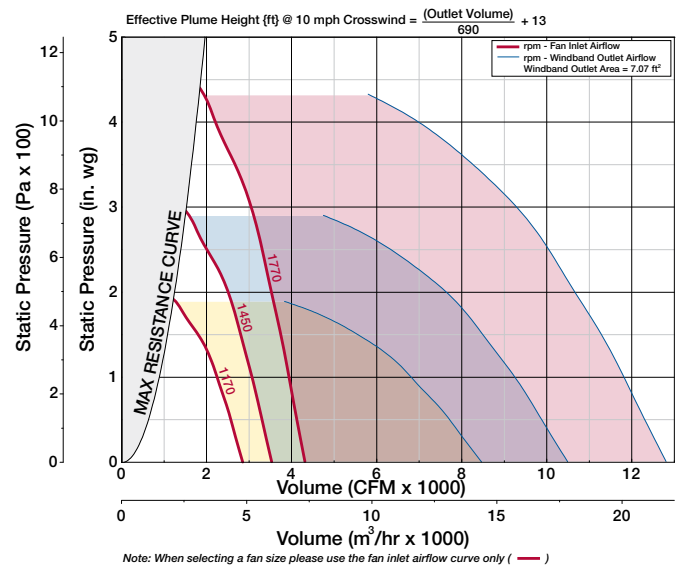
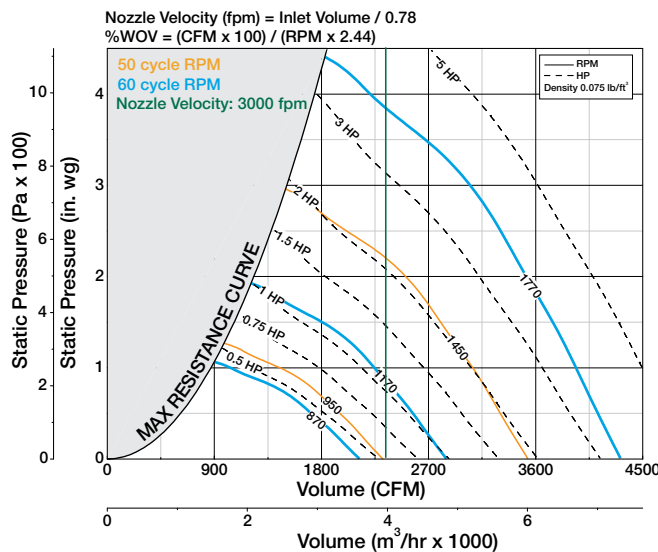
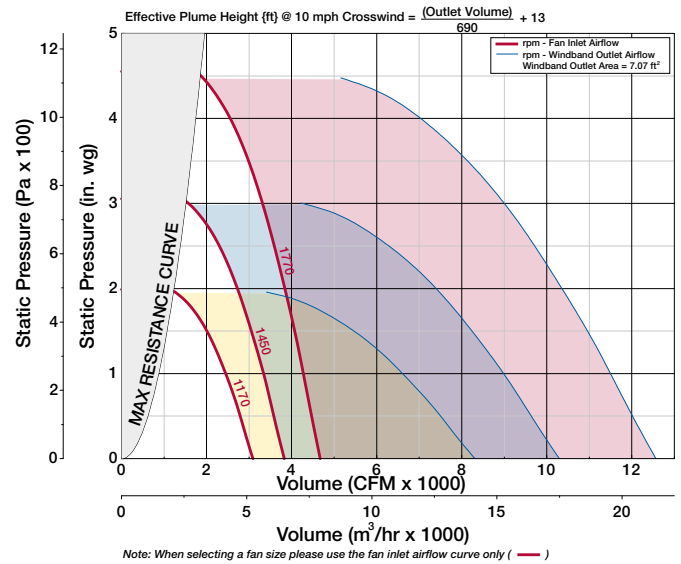
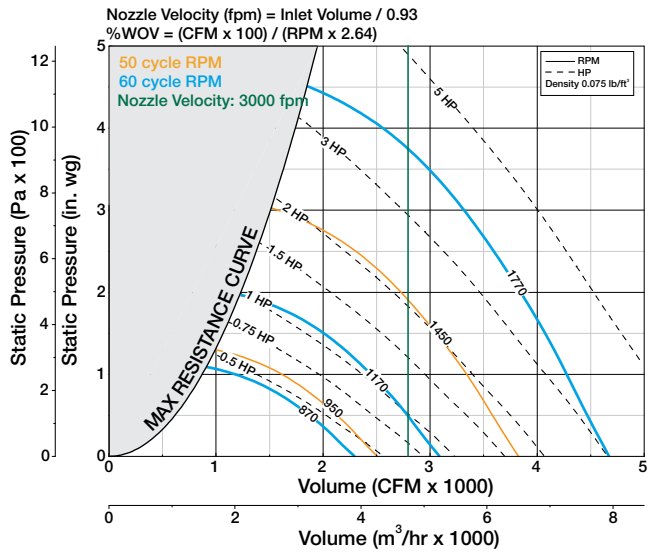
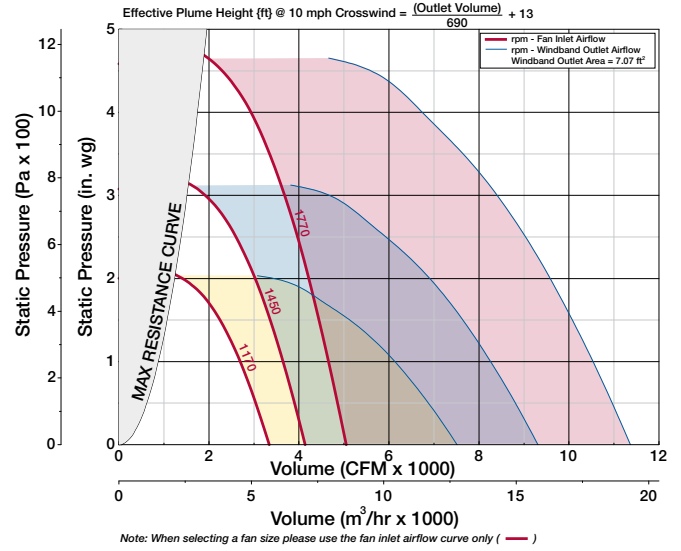
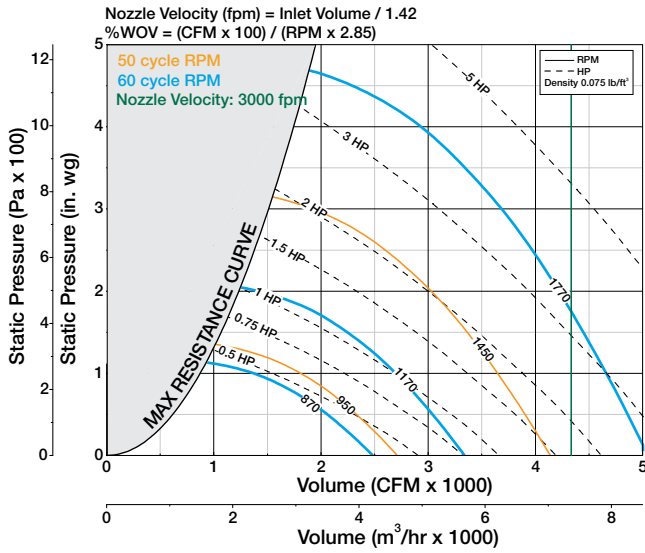
HV
High Velocity

Performance certified is for installation Type A: Free inlet, Free outlet. Power rating (Bhp) does not include transmission losses. Performance ratings do not include the effects of cross winds. Performance ratings do not include the effects of appurtenances (accessories).

Inlet Airflow

100% Wheel Width

Outlet Airflow

LV
Low Velocity

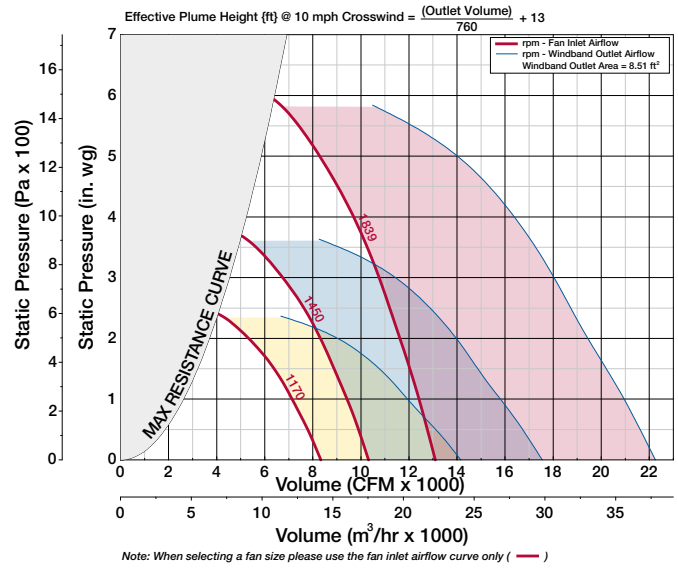
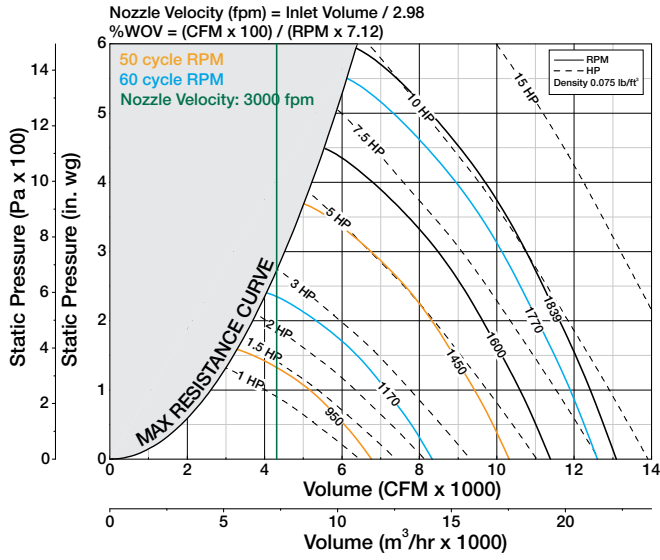

MV
Medium Velocity

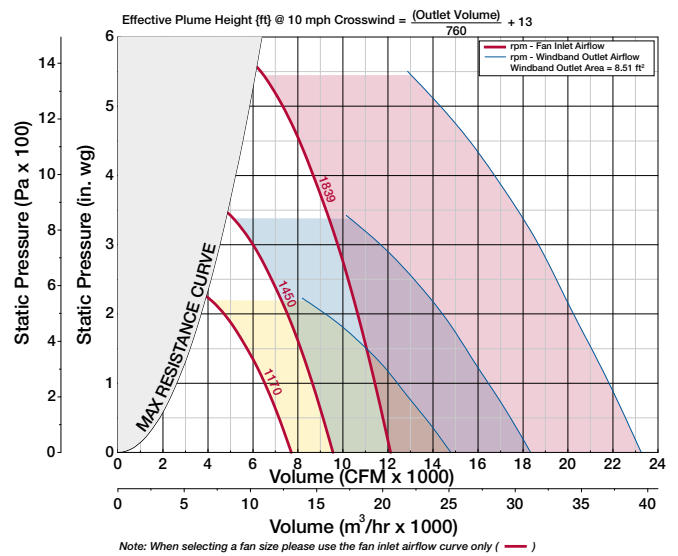
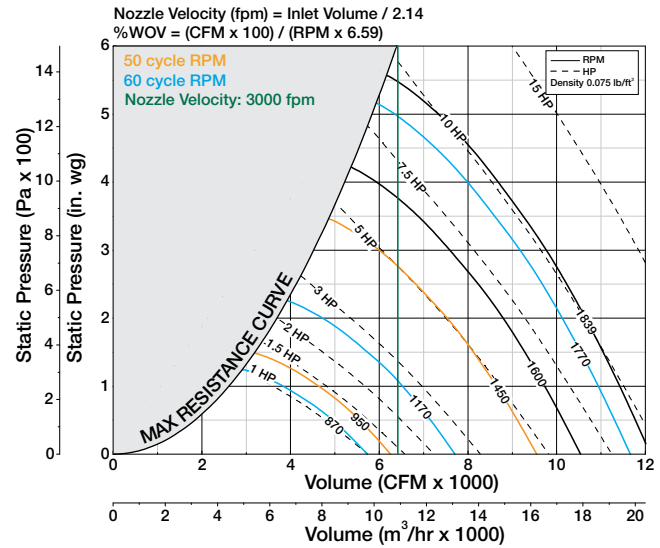

HV
High Velocity

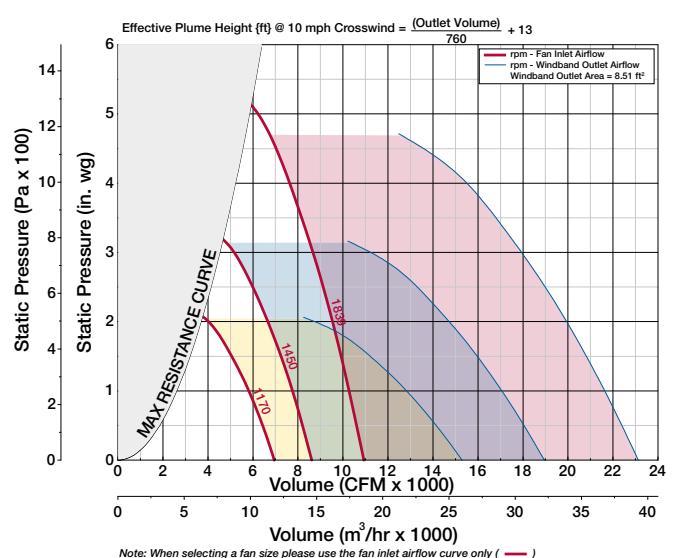
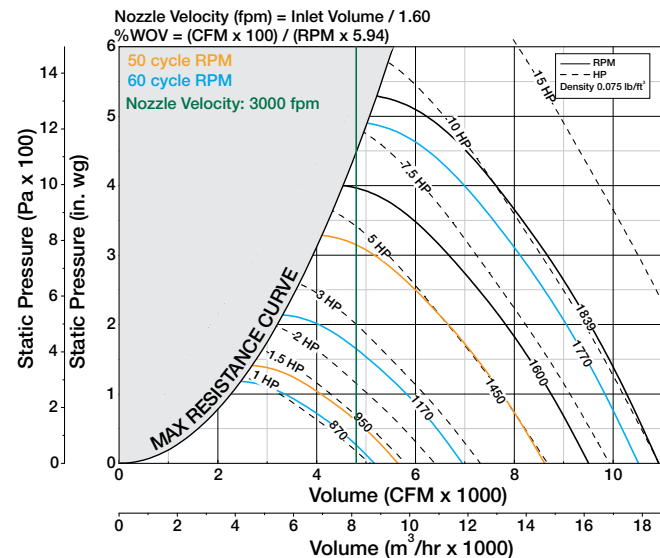

Performance certified is for installation Type A: Free inlet, Free outlet. Power rating (Bhp) does not include transmission losses. Performance ratings do not include the effects of cross winds. Performance ratings do not include the effects of appurtenances (accessories).

85% Wheel Width

Inlet Airflow

Outlet Airflow

AIR DATA

LV
Low Velocity

MV
Medium Velocity

HV
High Velocity

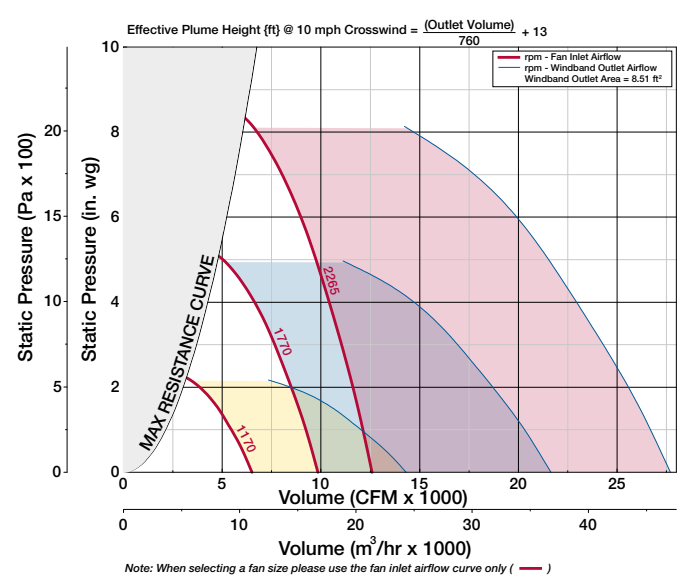
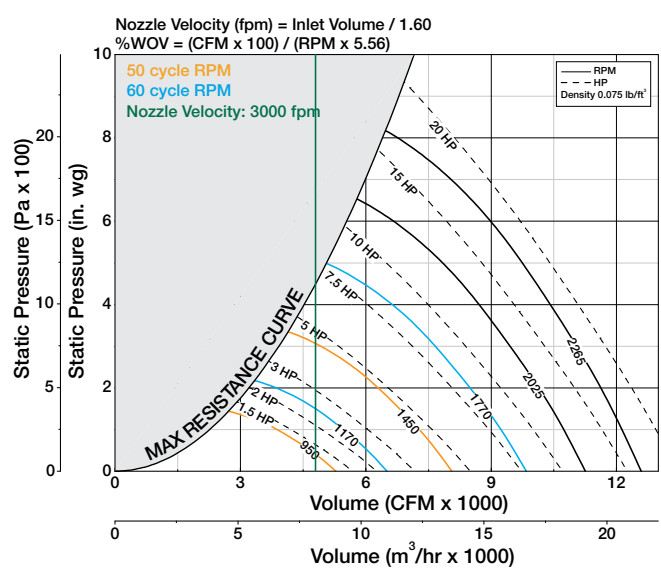
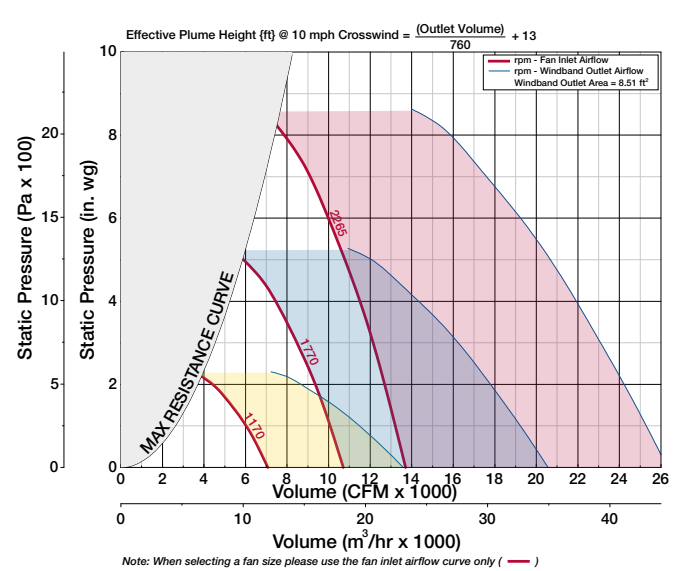
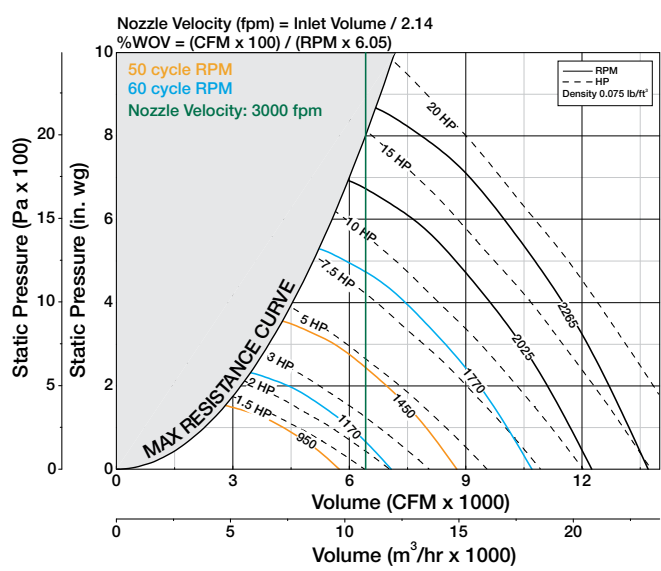
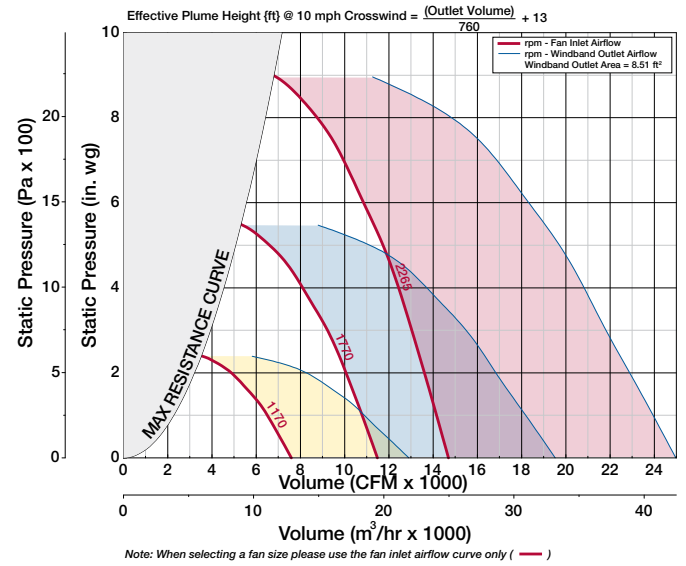
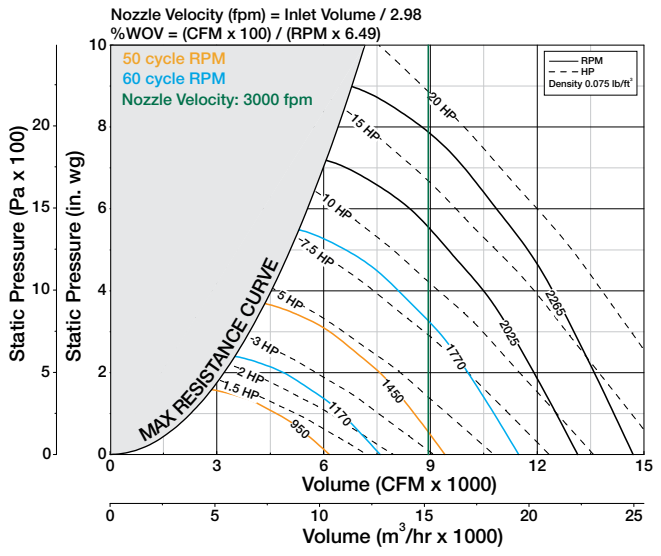

Performance certified is for installation Type A: Free inlet, Free outlet. Power rating (Bhp) does not include transmission losses. Performance ratings do not include the effects of cross winds. Performance ratings do not include the effects of appurtenances (accessories).

AIR DATA

Inlet Airflow

70% Wheel Width

Outlet Airflow

LV
Low Velocity

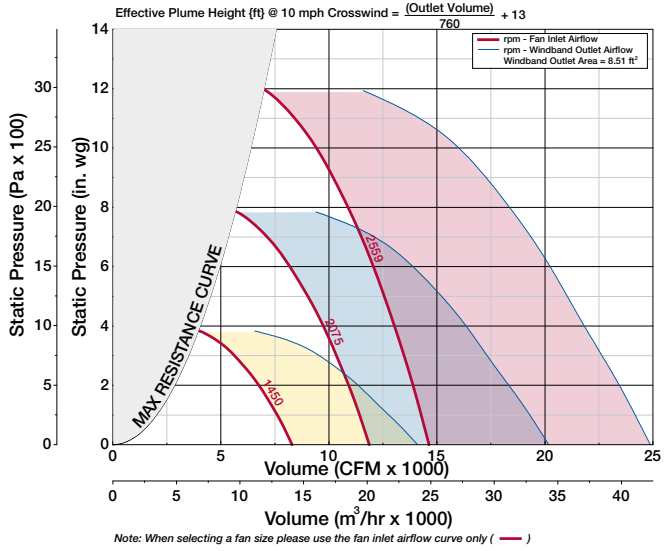
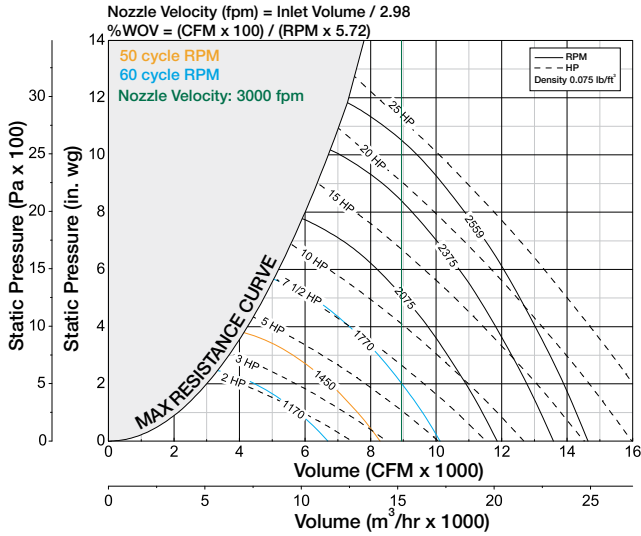

MV
Medium Velocity

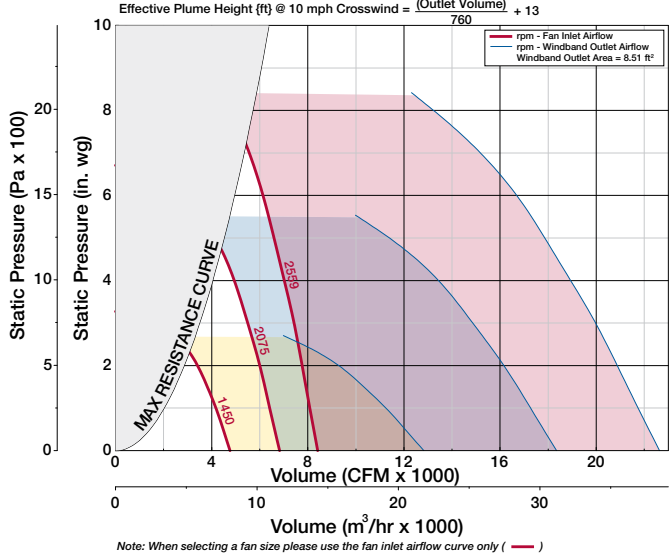
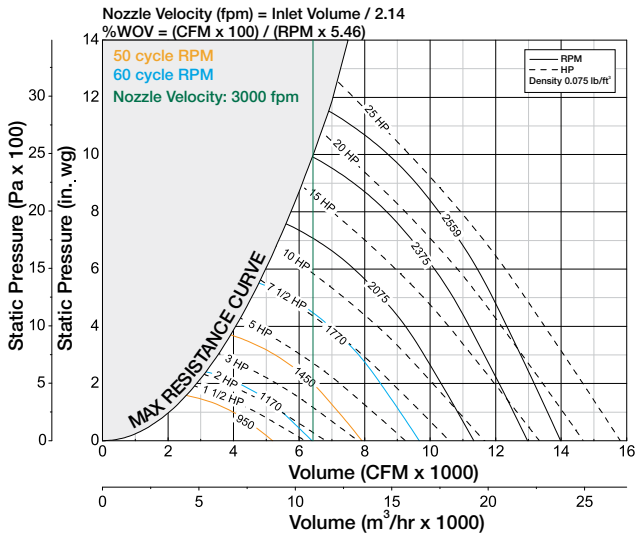

HV
High Velocity

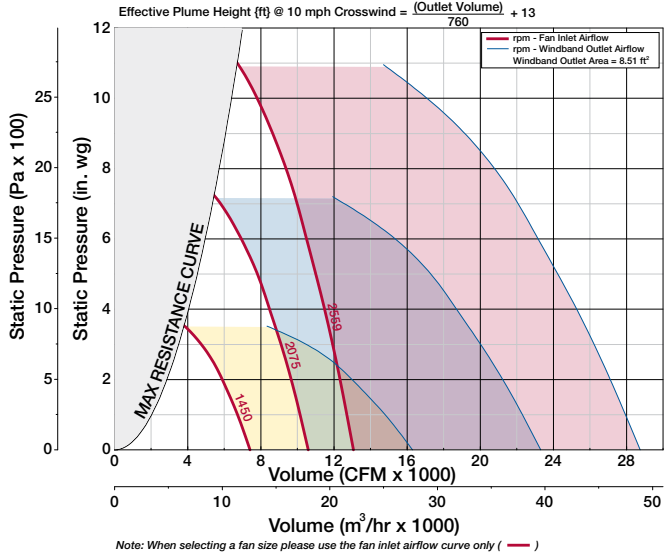
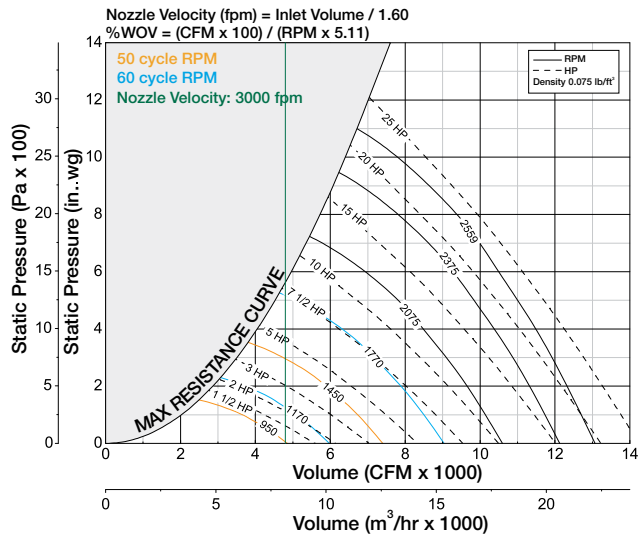

Performance certified is for installation Type A: Free inlet, Free outlet. Power rating (Bhp) does not include transmission losses. Performance ratings do not include the effects of cross winds. Performance ratings do not include the effects of appurtenances (accessories).

Inlet Airflow

50% Wheel Width

Outlet Airflow

AIR DATA

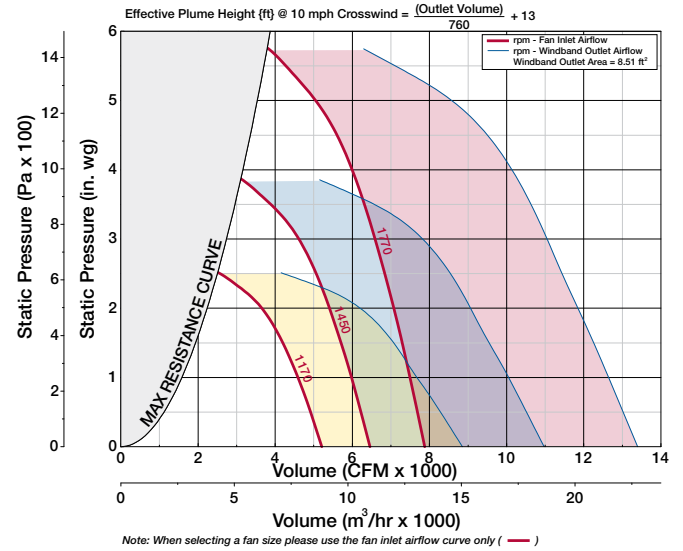
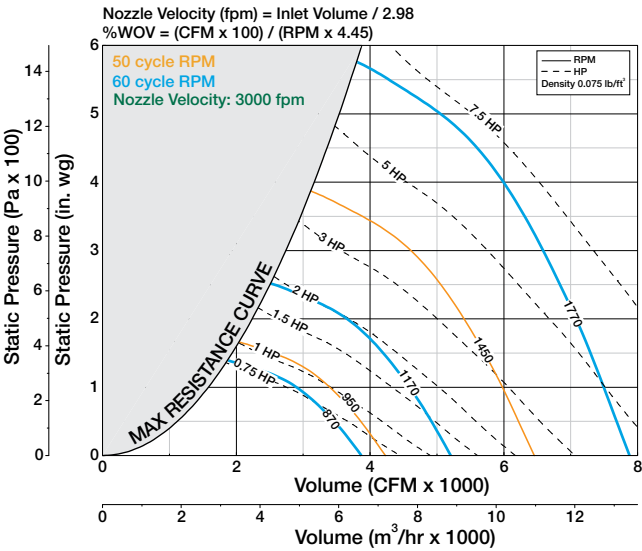

LV
Low Velocity

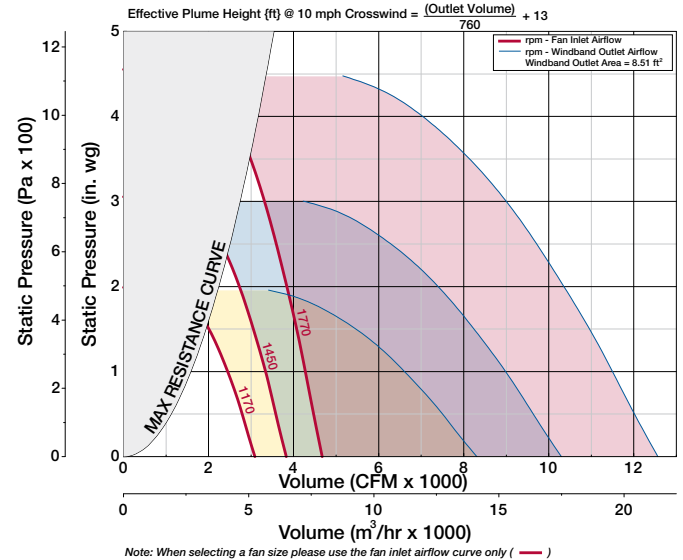
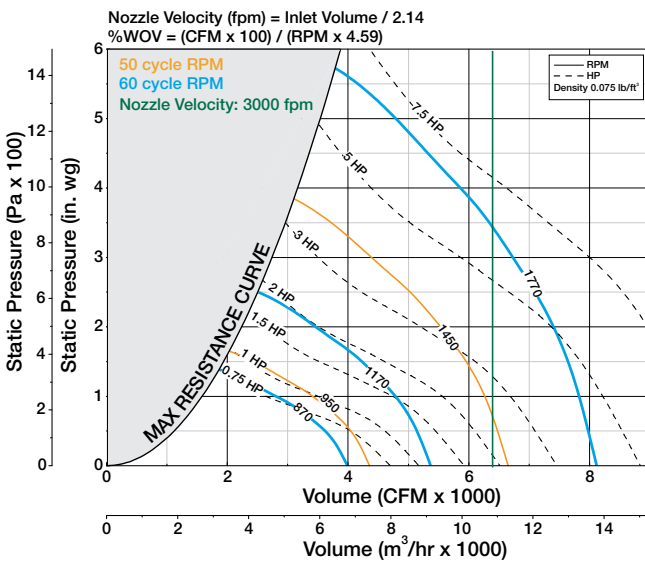

MV
Medium Velocity

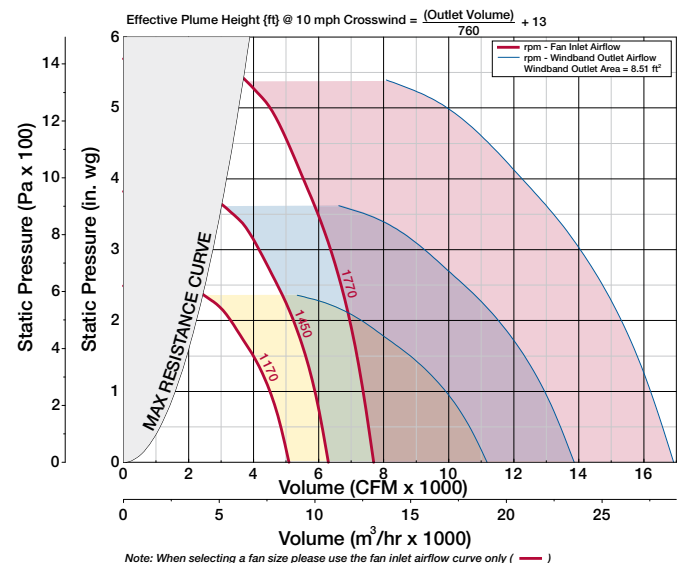
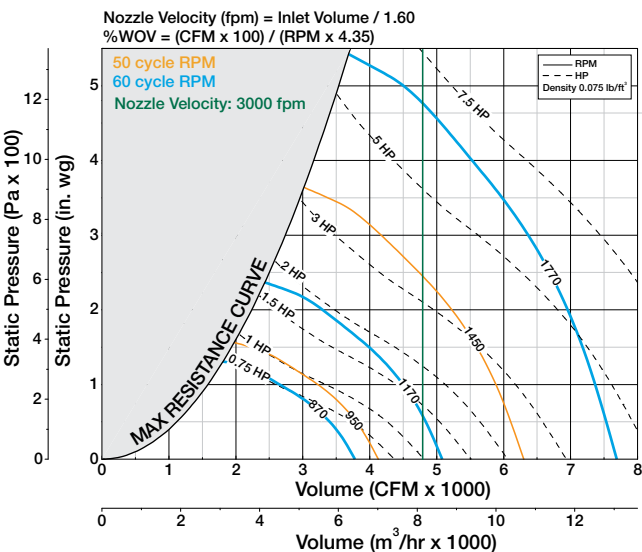

HV
High Velocity

Performance certified is for installation Type A: Free inlet, Free outlet. Power rating (Bhp) does not include transmission losses. Performance ratings do not include the effects of cross winds. Performance ratings do not include the effects of appurtenances (accessories).

AIR DATA

Inlet Airflow

100% Wheel Width

Outlet Airflow

LV
Low Velocity

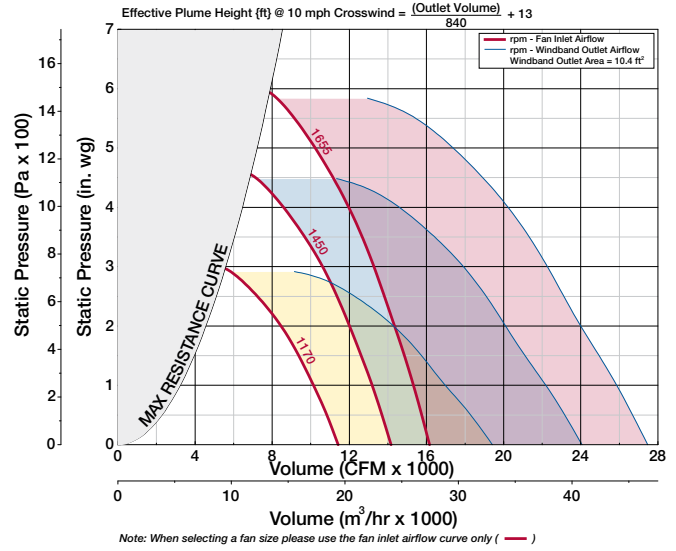
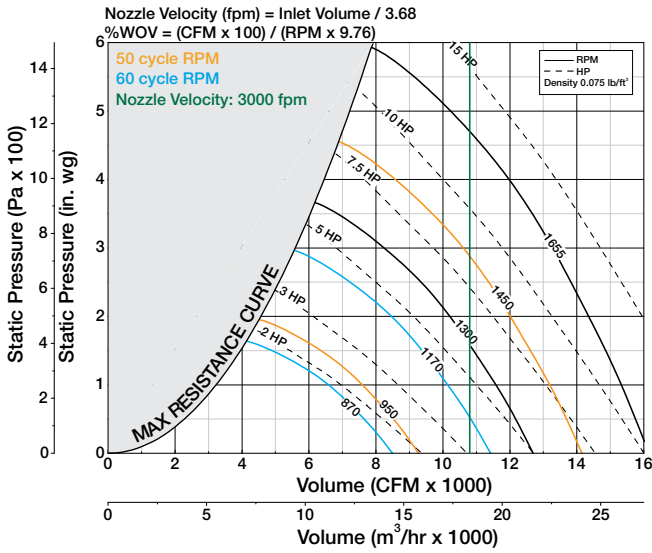

MV
Medium Velocity

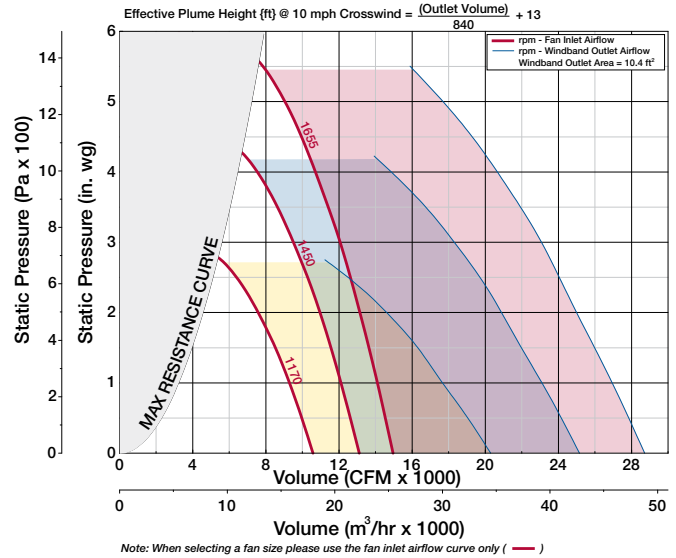
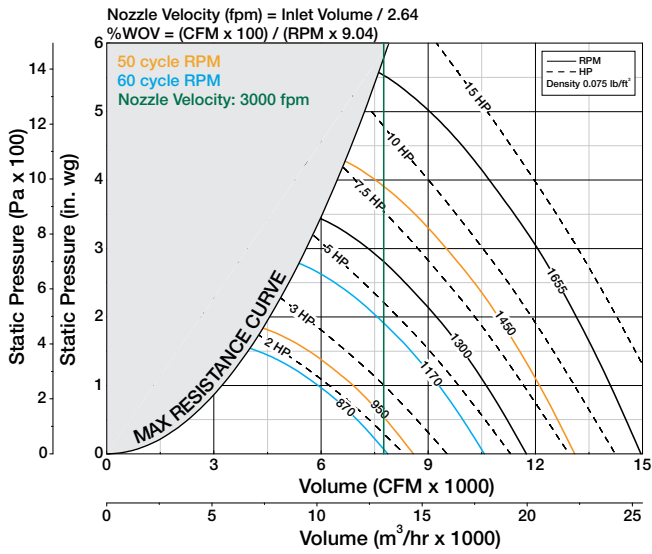

HV
High Velocity

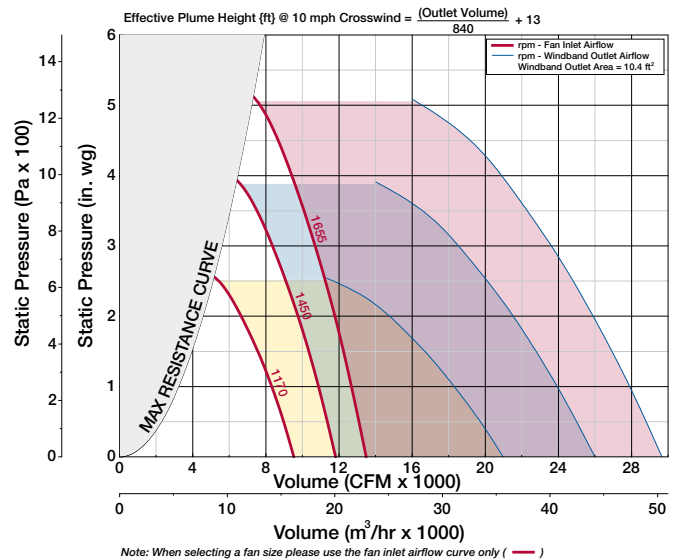
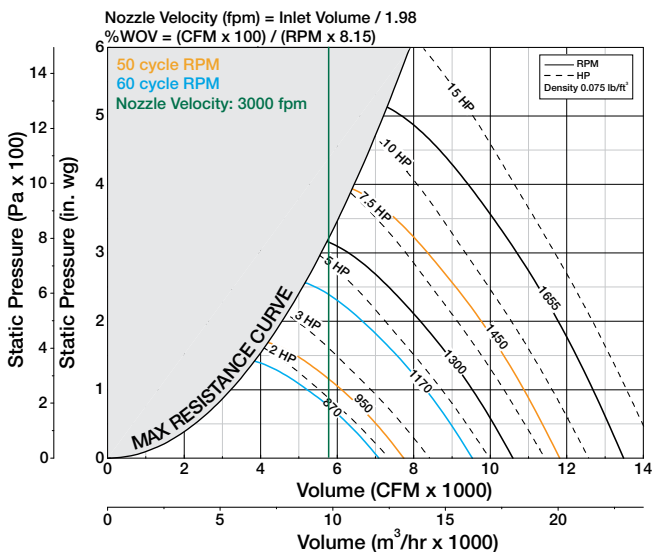

Performance certified is for installation Type A: Free inlet, Free outlet. Power rating (Bhp) does not include transmission losses. Performance ratings do not include the effects of cross winds. Performance ratings do not include the effects of appurtenances (accessories).

Inlet Airflow 85% Wheel Width Outlet Airflow

AIR DATA
LV
Low Velocity

MV
Medium Velocity

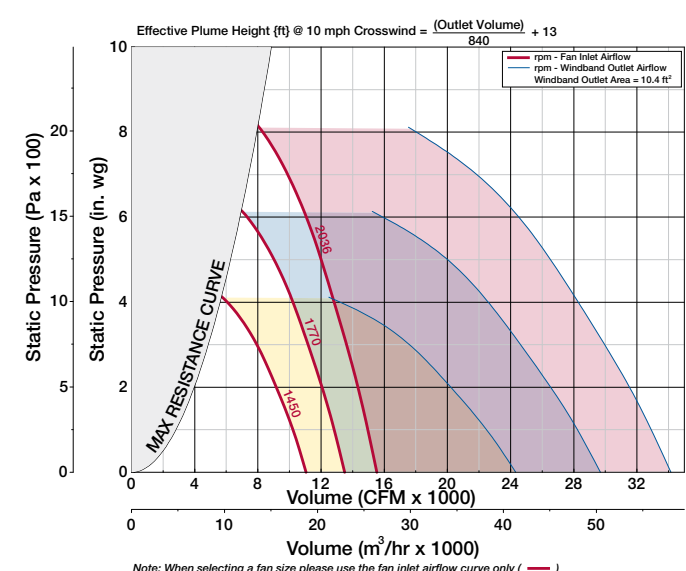
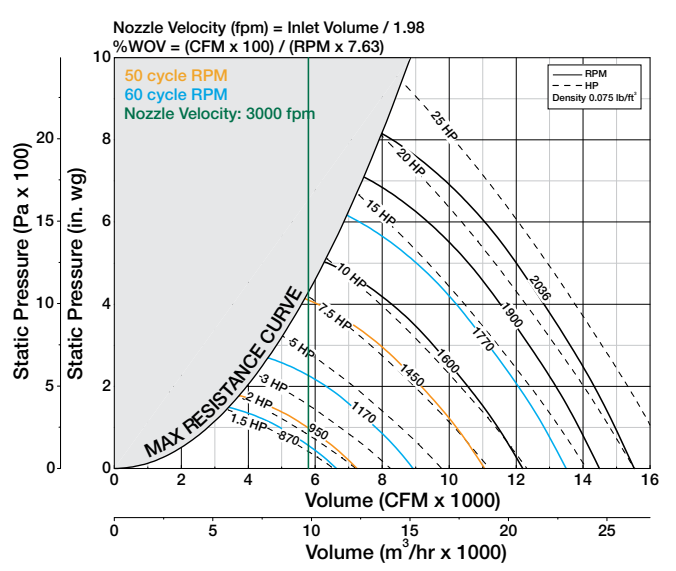
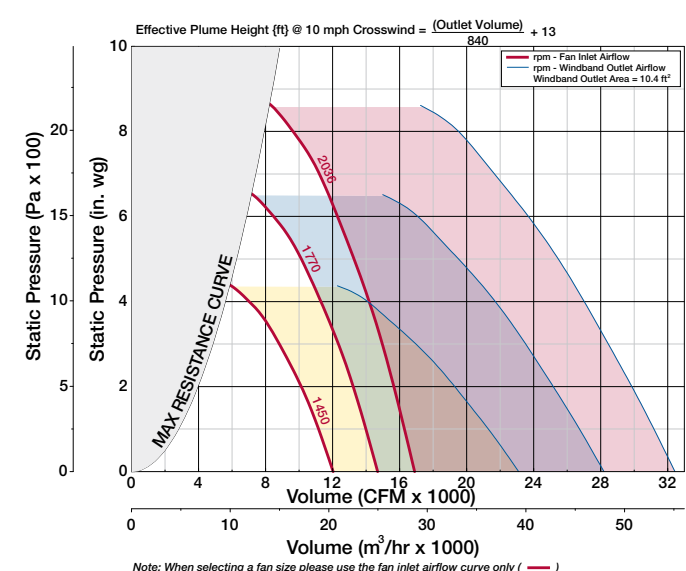
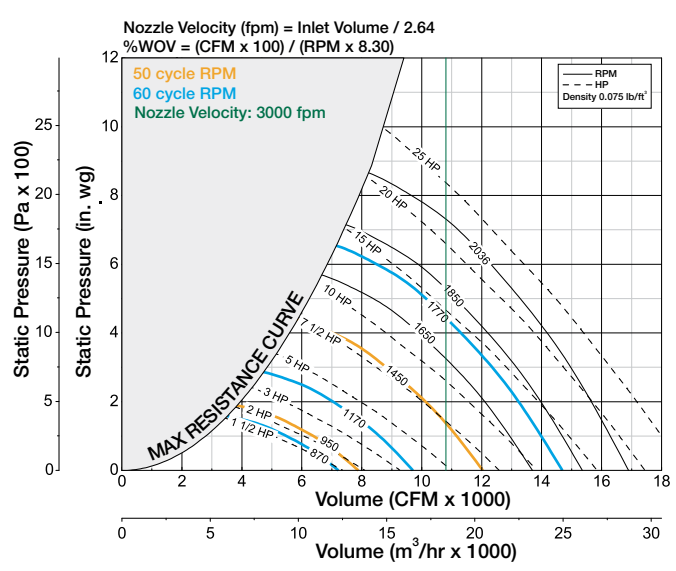
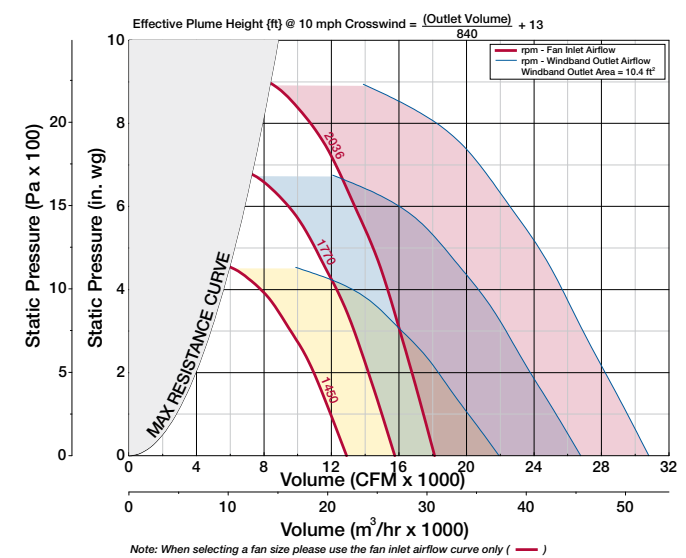
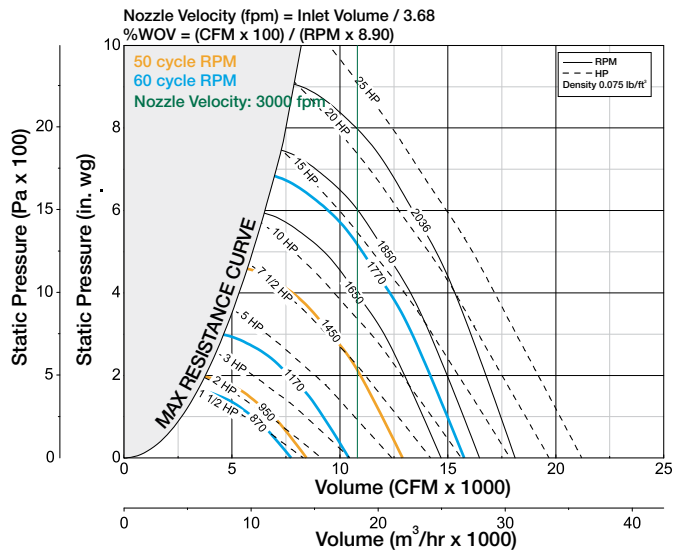
HV
High Velocity

Performance certified is for installation Type A: Free inlet, Free outlet. Power rating (Bhp) does not include transmission losses. Performance ratings do not include the effects of cross winds. Performance ratings do not include the effects of appurtenances (accessories).

AIR DATA

Inlet Airflow

70% Wheel Width

Outlet Airflow

LV
Low Velocity

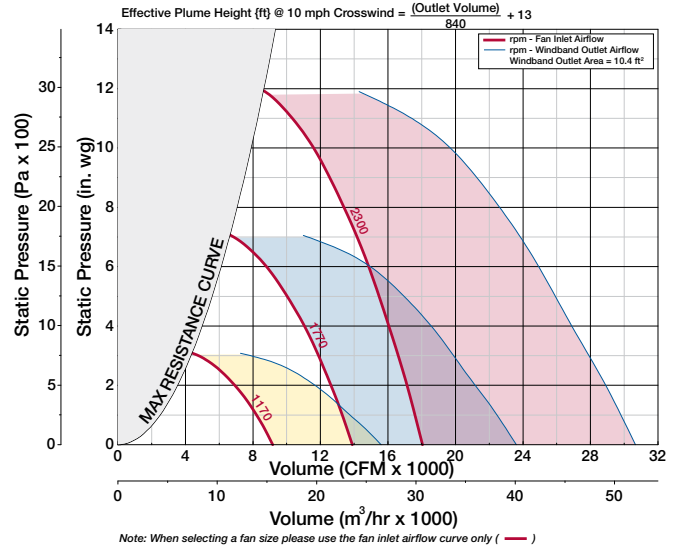
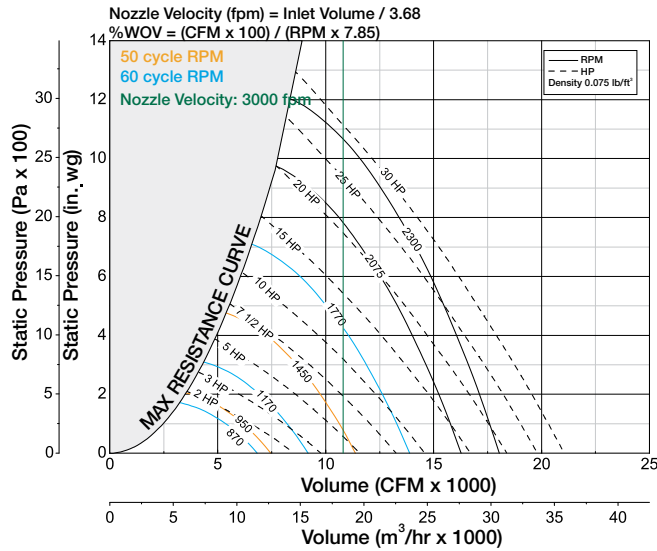

MV
Medium Velocity

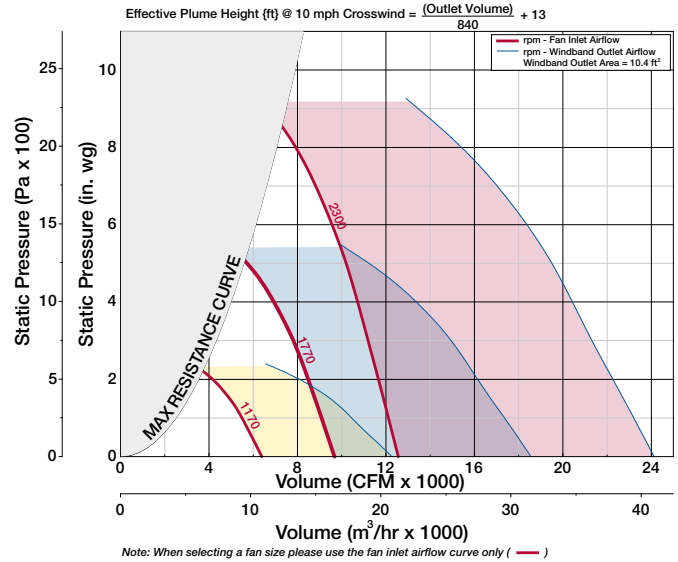
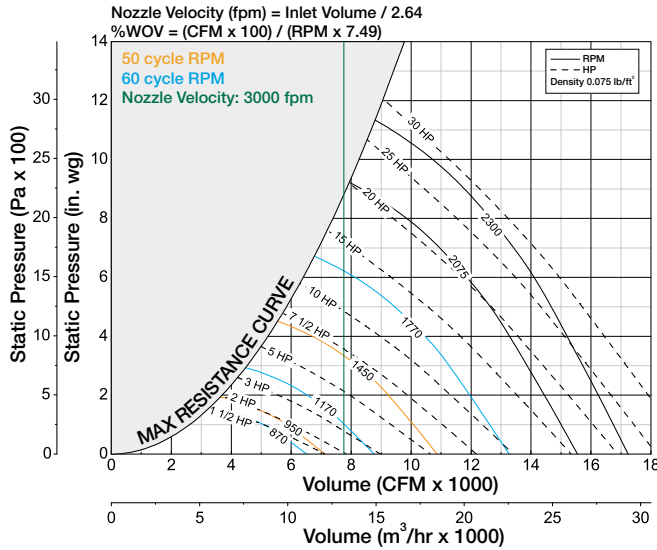

HV
High Velocity

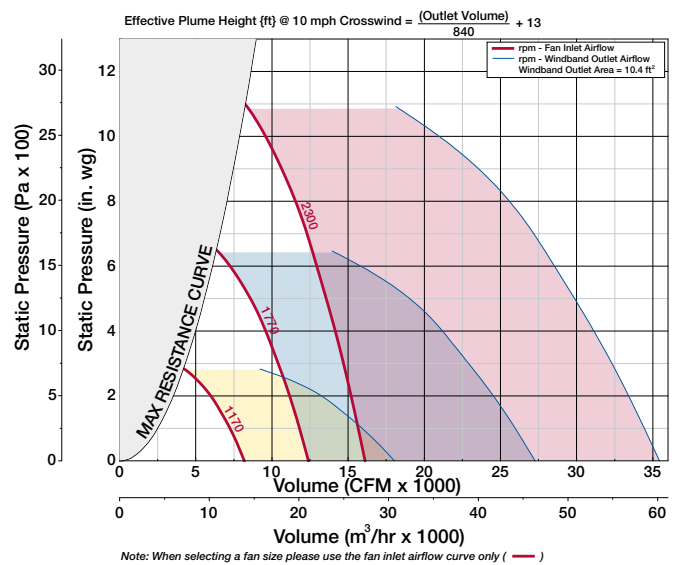
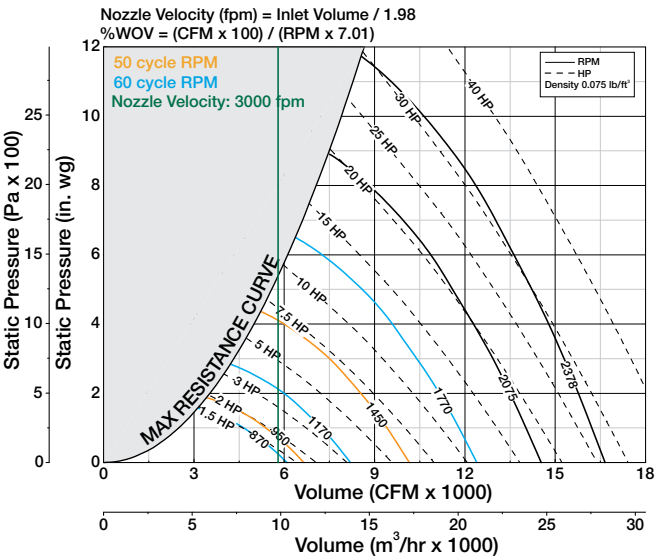

Performance certified is for installation Type A: Free inlet, Free outlet. Power rating (Bhp) does not include transmission losses. Performance ratings do not include the effects of cross winds. Performance ratings do not include the effects of appurtenances (accessories).

Inlet Airflow

50% Wheel Width

Outlet Airflow

AIR DATA

LV
Low Velocity

MV
Medium Velocity

HV
High Velocity

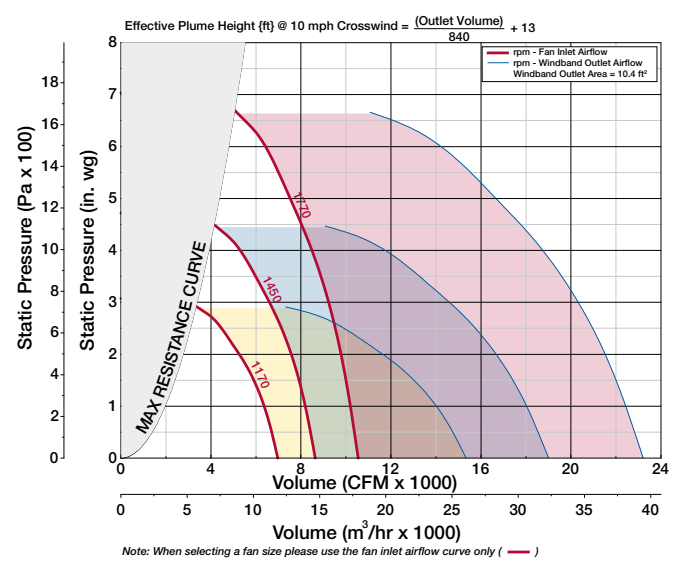
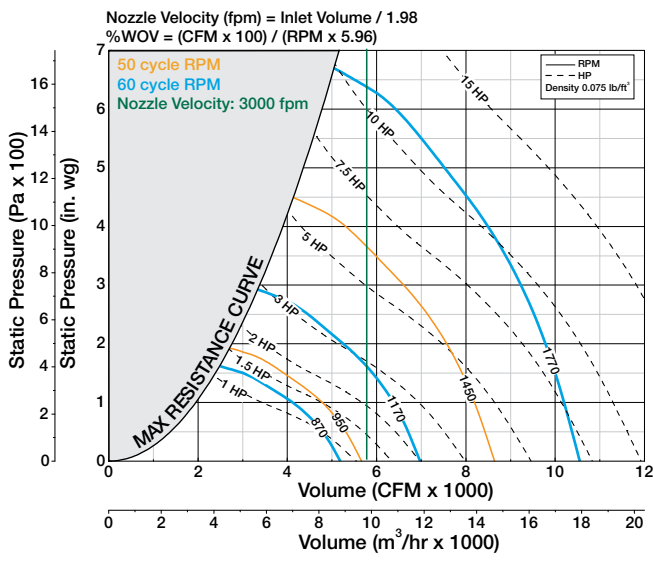
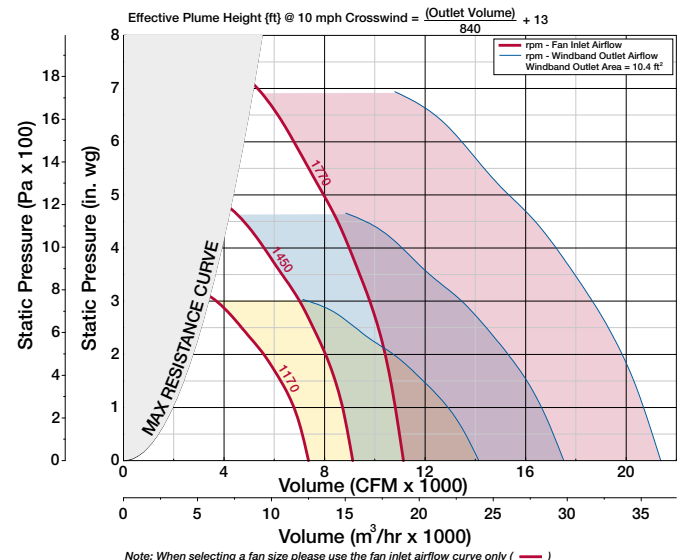
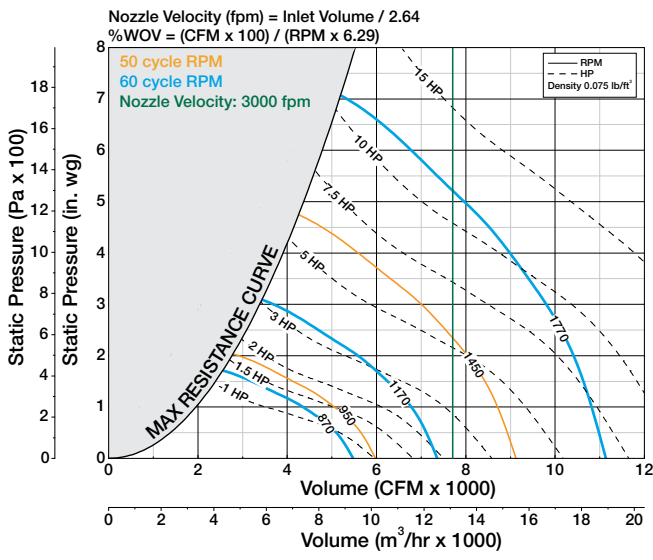
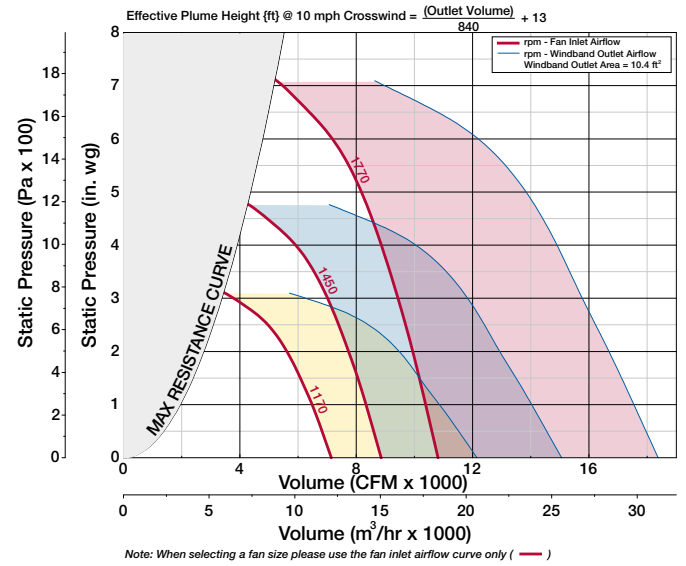
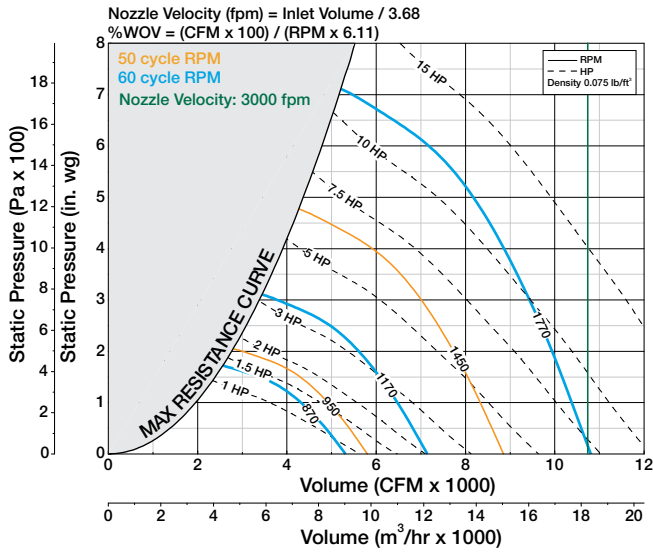

Performance certified is for installation Type A: Free inlet, Free outlet. Power rating (Bhp) does not include transmission losses. Performance ratings do not include the effects of cross winds. Performance ratings do not include the effects of appurtenances (accessories).

AIR DATA

Inlet Airflow

100% Wheel Width

Outlet Airflow

LV
Low Velocity

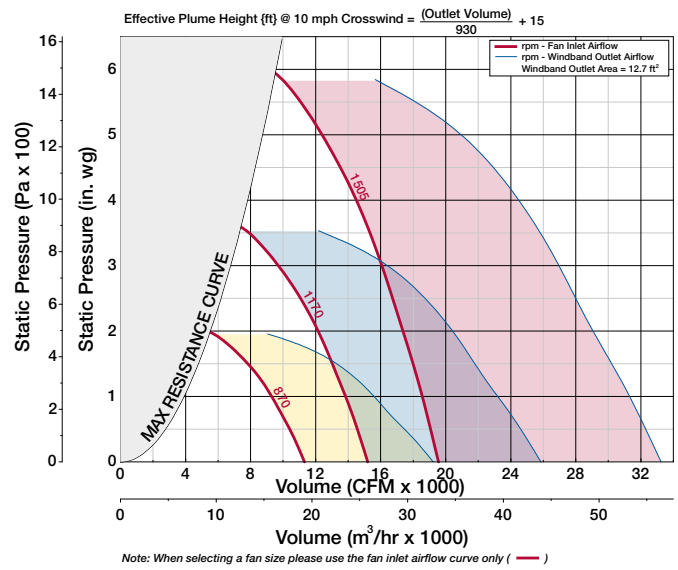
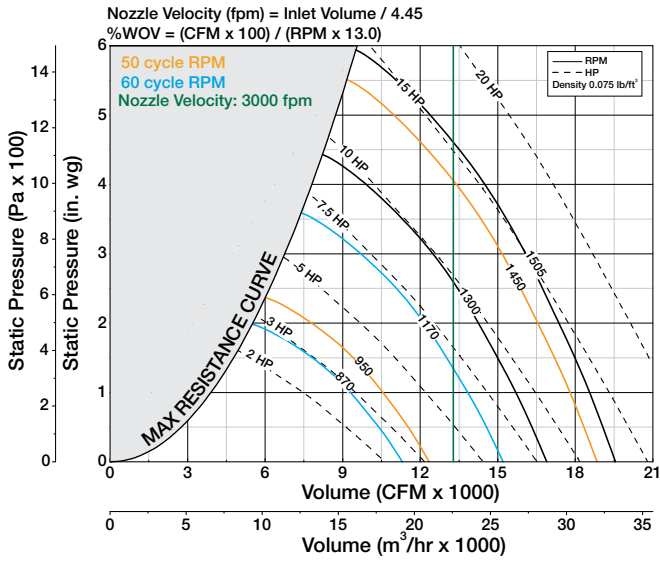

MV
Medium Velocity

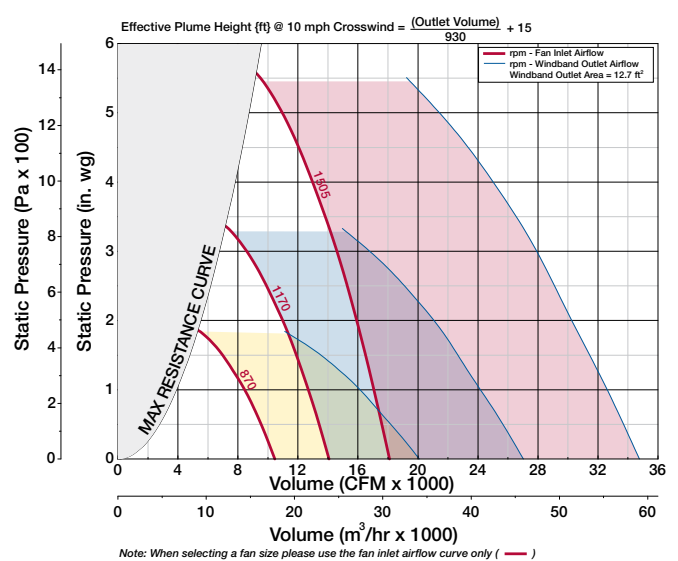
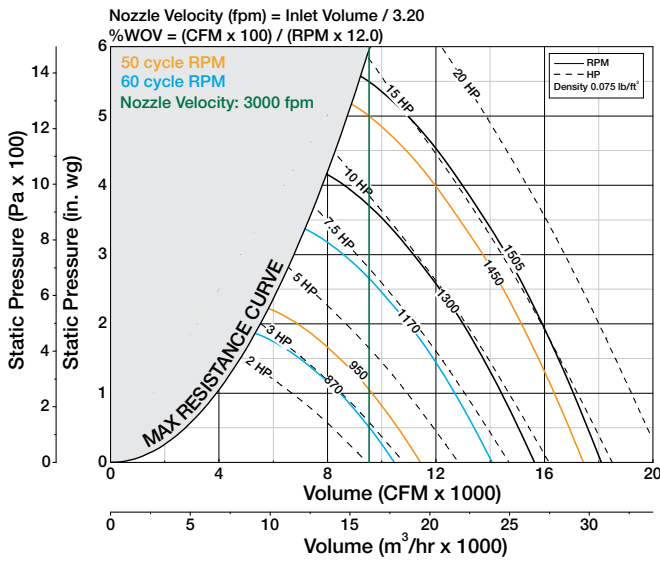

HV
High Velocity

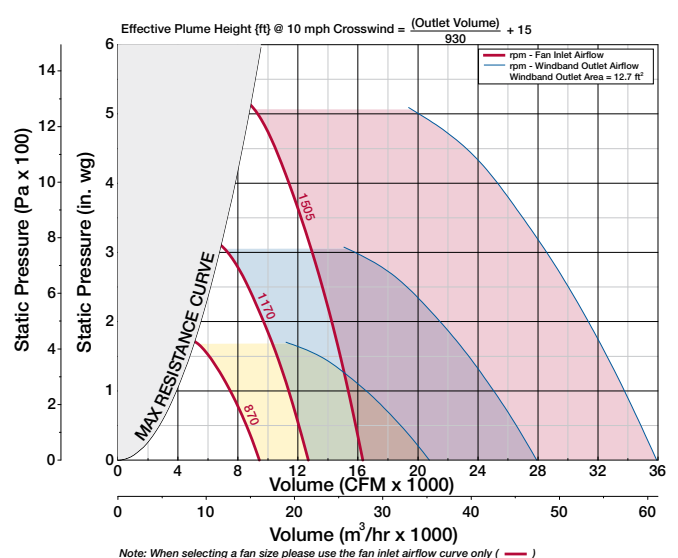
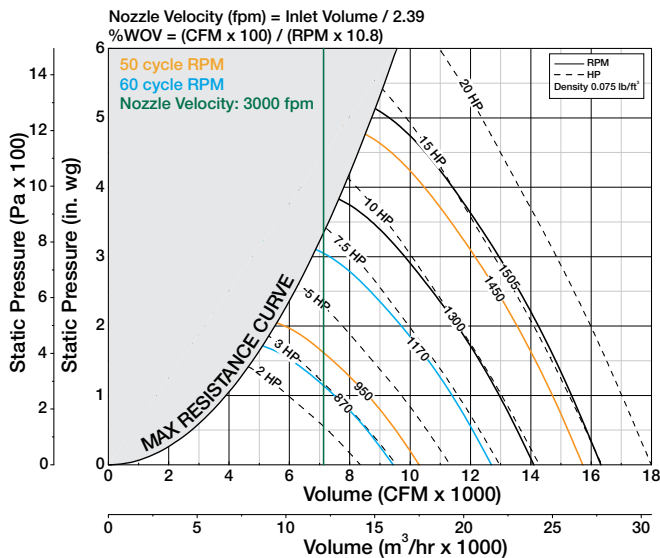

Performance certified is for installation Type A: Free inlet, Free outlet. Power rating (Bhp) does not include transmission losses. Performance ratings do not include the effects of cross winds. Performance ratings do not include the effects of appurtenances (accessories).

85% Wheel Width

Inlet Airflow

Outlet Airflow

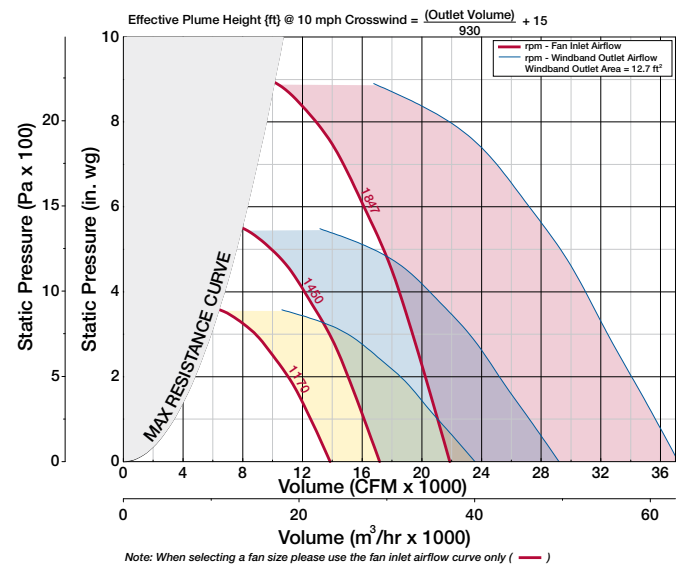
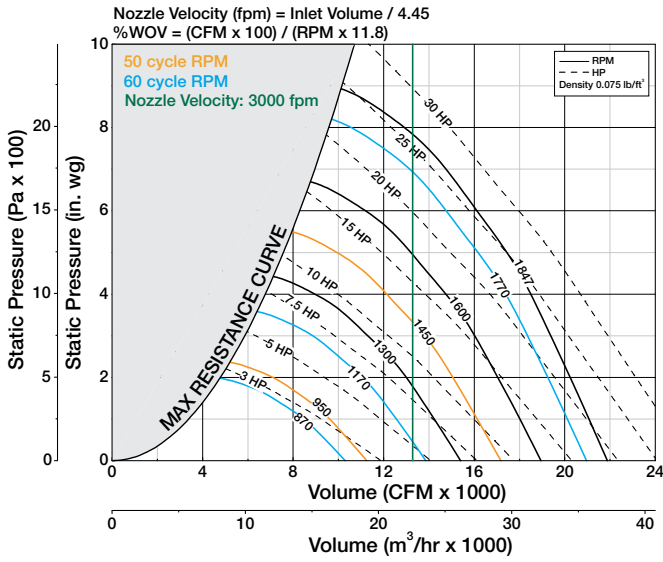

AIR DATA

LV
Low Velocity

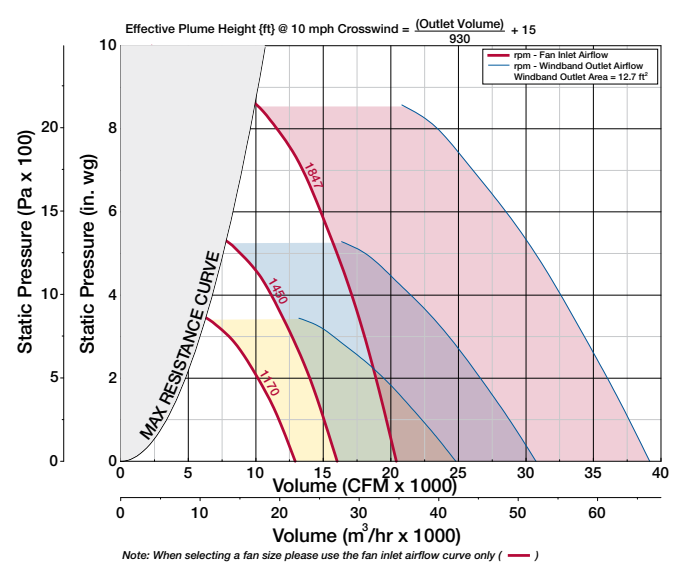
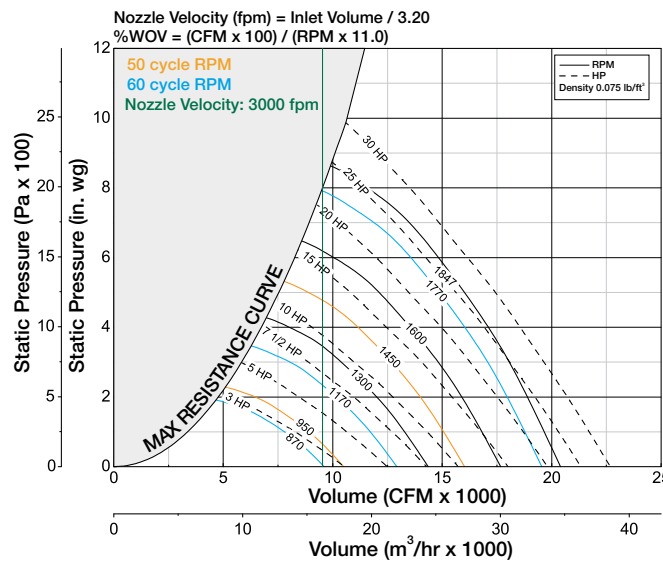

MV
Medium Velocity

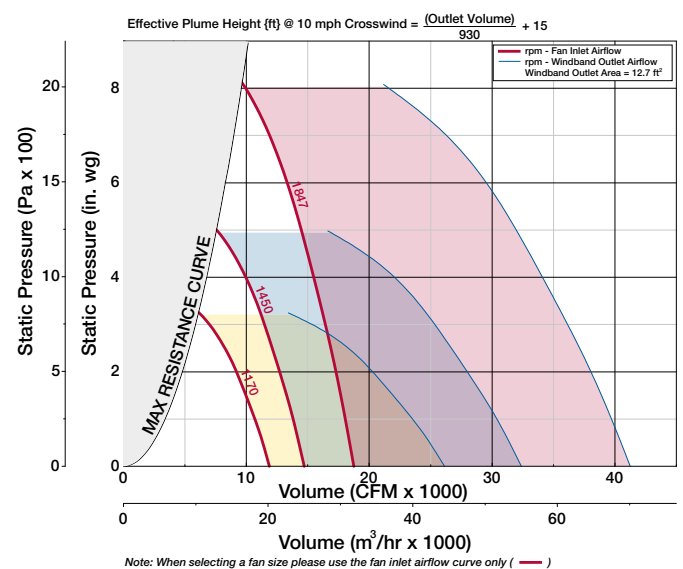
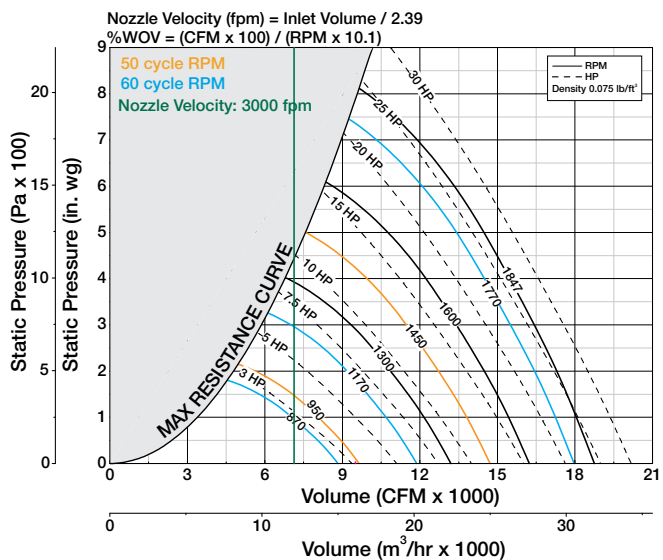

HV
High Velocity

Performance certified is for installation Type A: Free inlet, Free outlet. Power rating (Bhp) does not include transmission losses. Performance ratings do not include the effects of cross winds. Performance ratings do not include the effects of appurtenances (accessories).

AIR DATA

Inlet Airflow

70% Wheel Width

Outlet Airflow

LV
Low Velocity

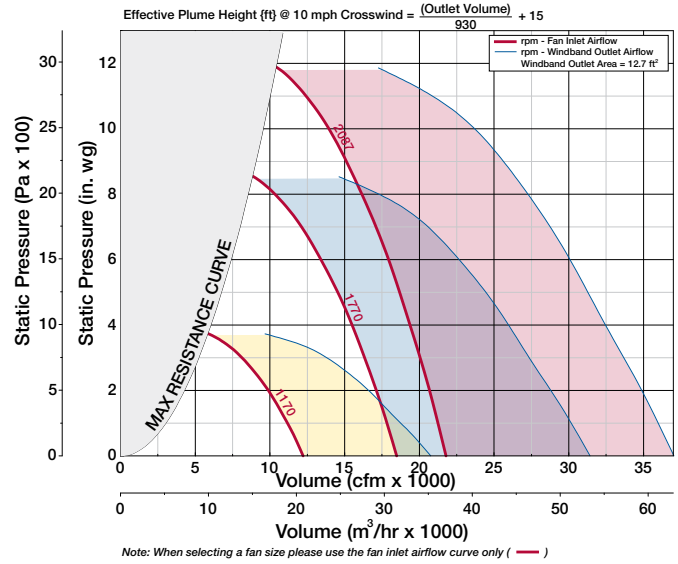
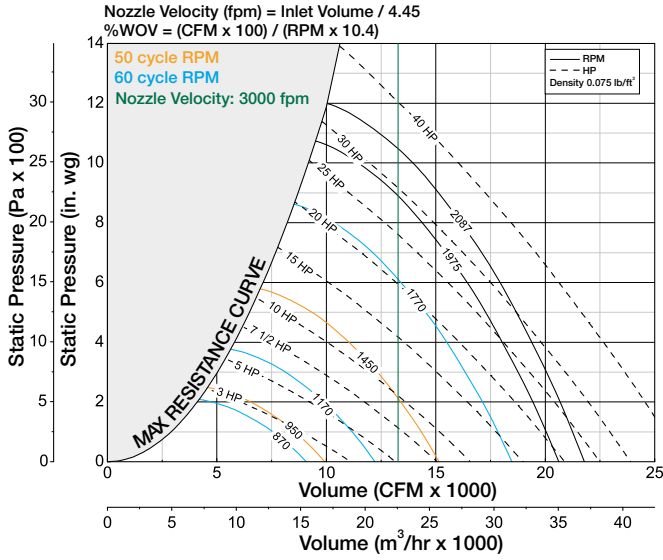

MV
Medium Velocity

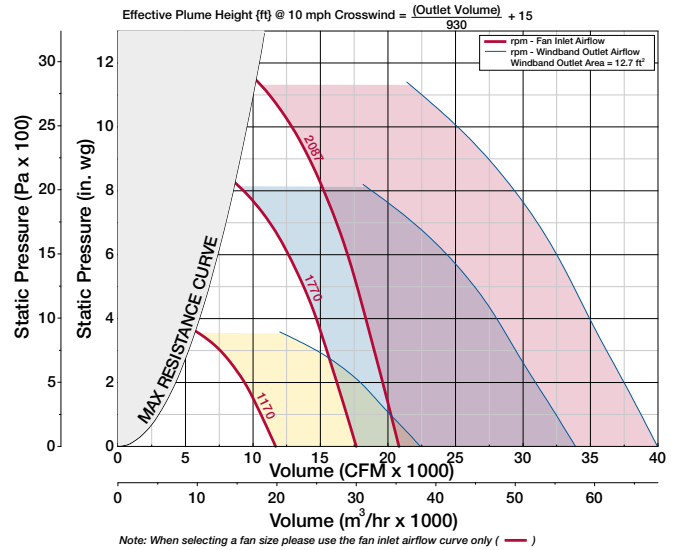
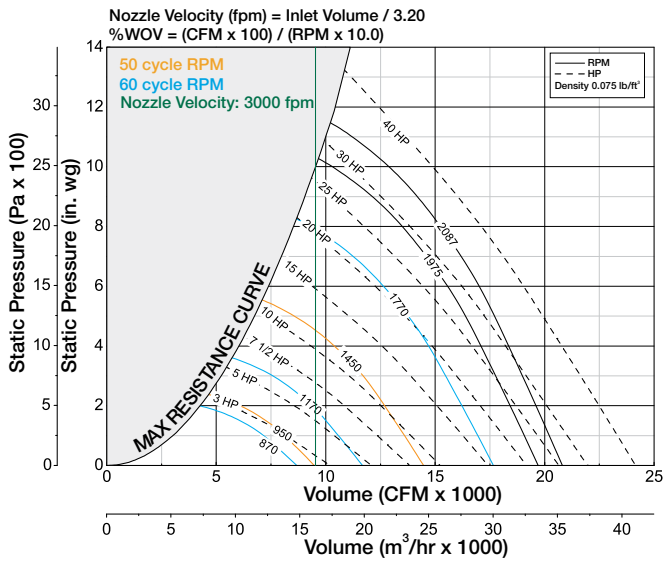

HV
High Velocity

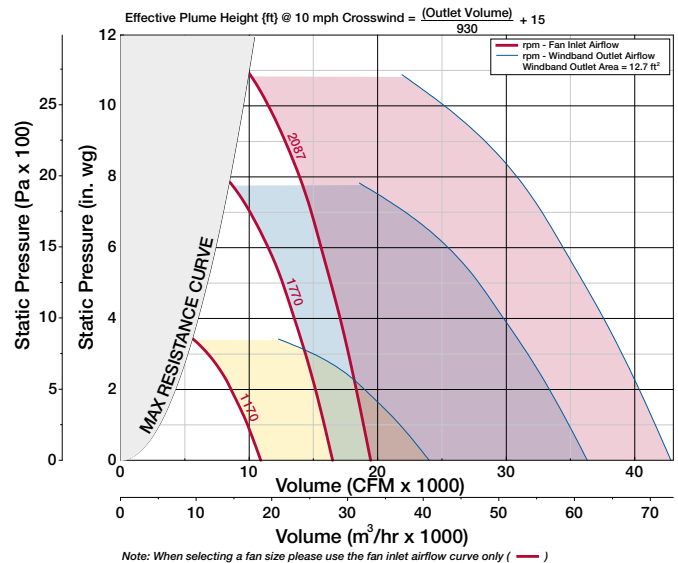
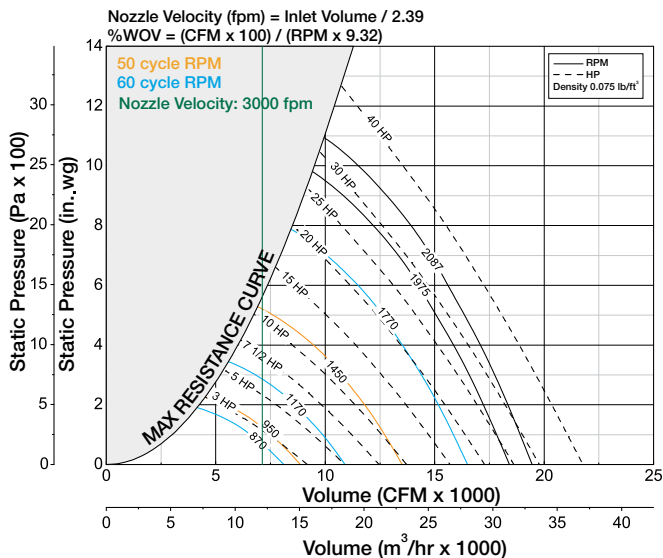

Performance certified is for installation Type A: Free inlet, Free outlet. Power rating (Bhp) does not include transmission losses. Performance ratings do not include the effects of cross winds. Performance ratings do not include the effects of appurtenances (accessories).

Inlet Airflow 50% Wheel Width Outlet Airflow

AIR DATA
LV
Low Velocity

MV
Medium Velocity

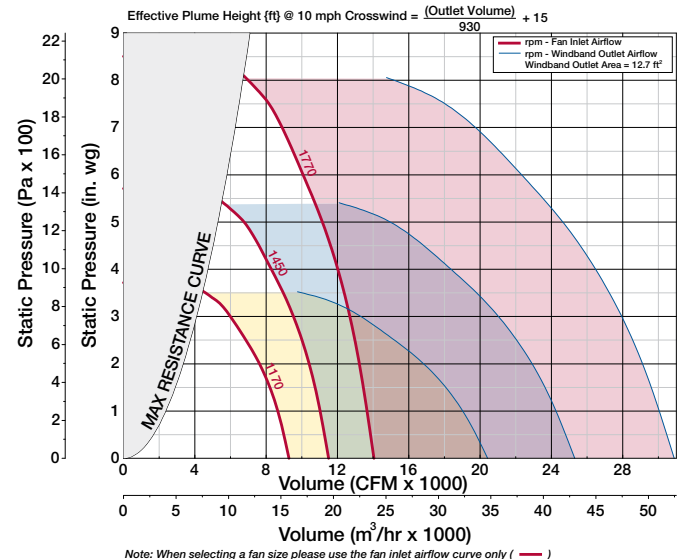
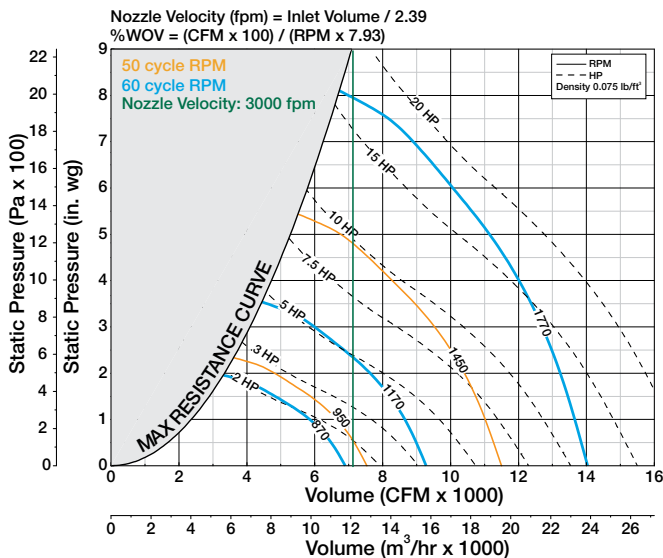
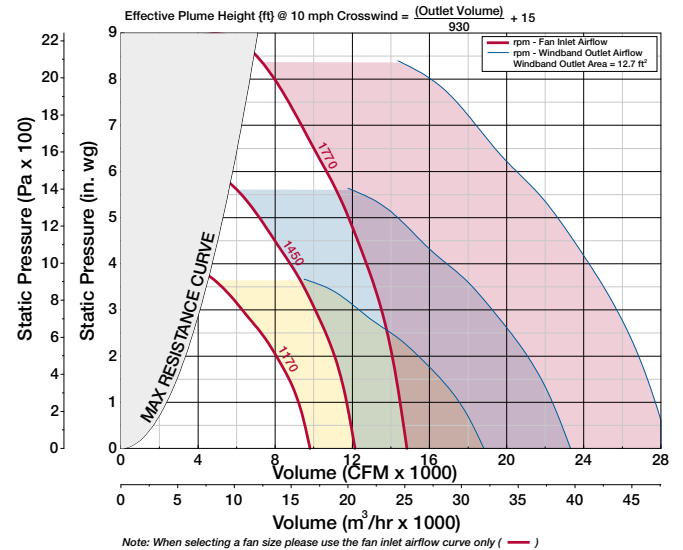
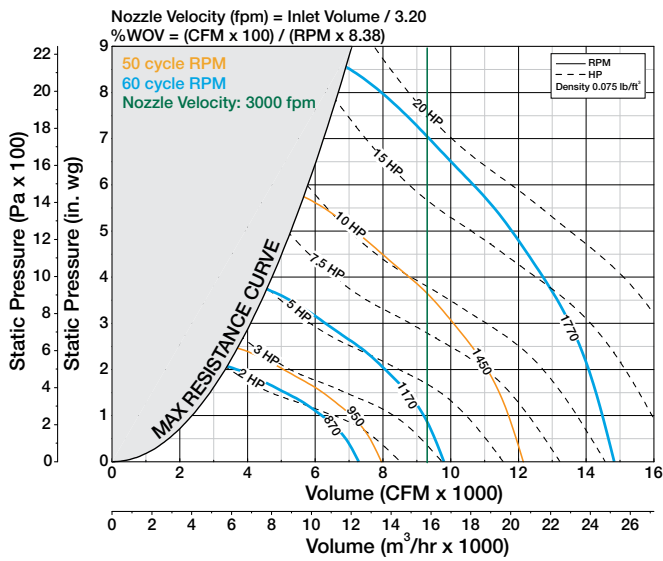
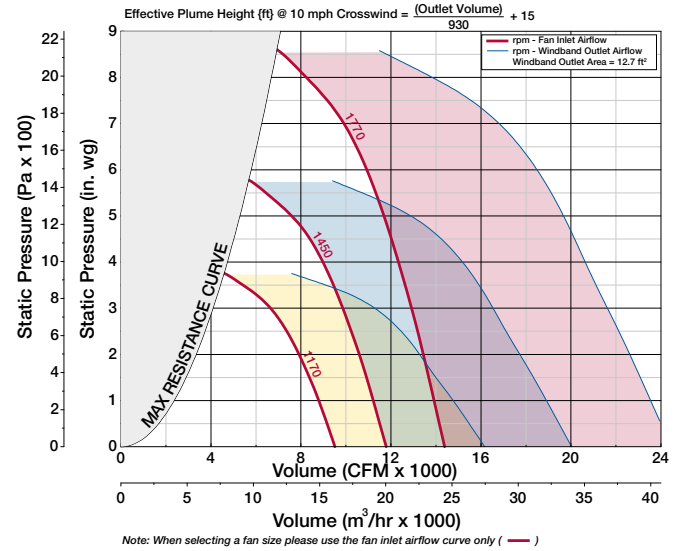
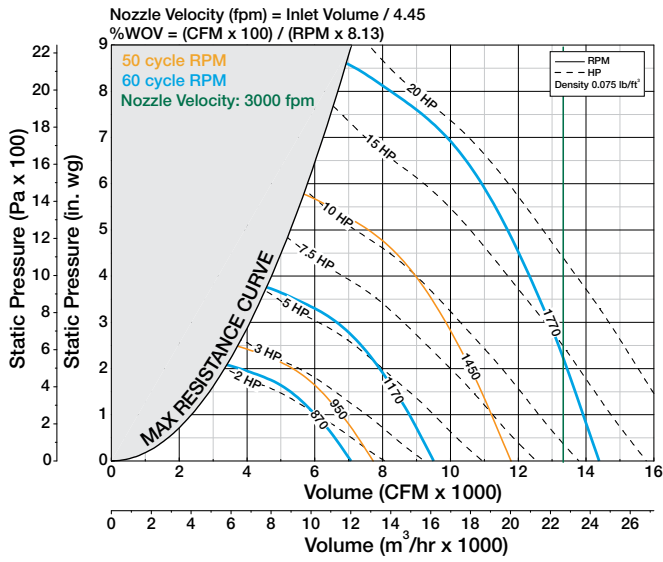
HV
High Velocity

Performance certified is for installation Type A: Free inlet, Free outlet. Power rating (Bhp) does not include transmission losses. Performance ratings do not include the effects of cross winds. Performance ratings do not include the effects of appurtenances (accessories).

AIR DATA

Inlet Airflow

100% Wheel Width

Outlet Airflow

LV
Low Velocity

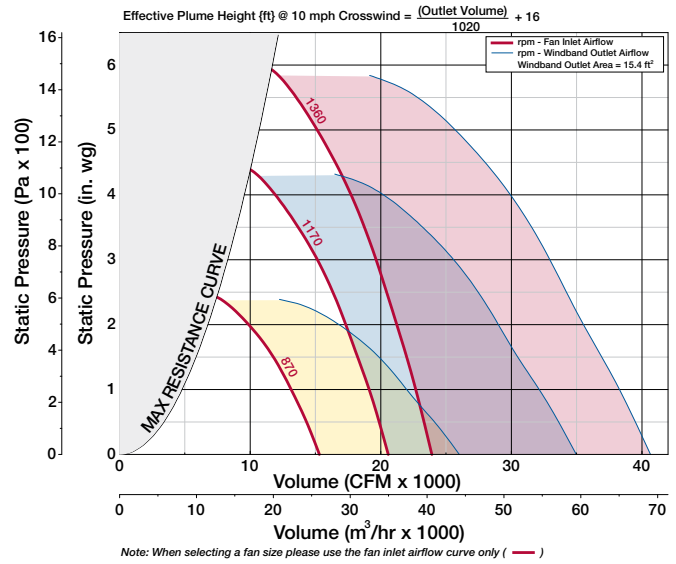
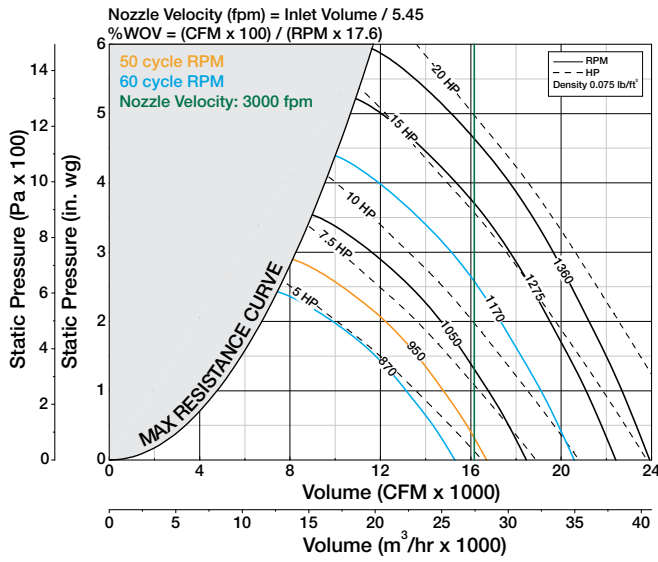

MV
Medium Velocity

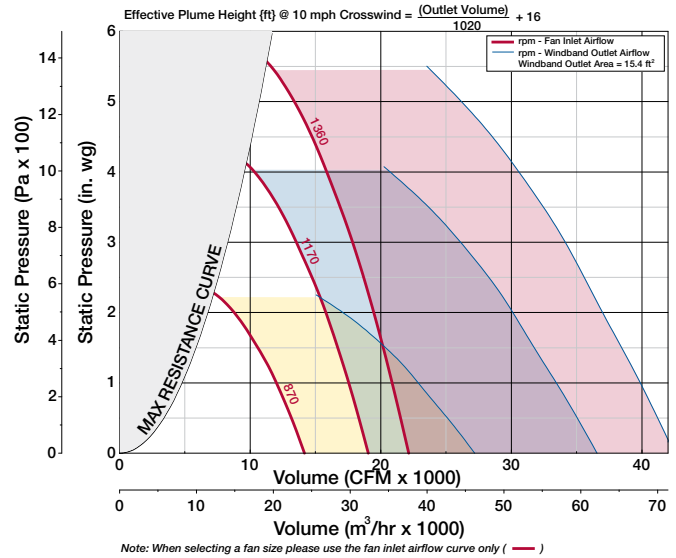
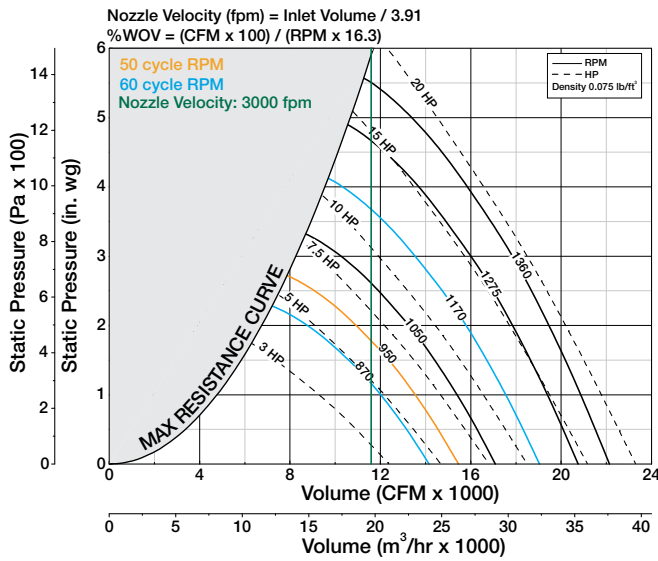

HV
High Velocity

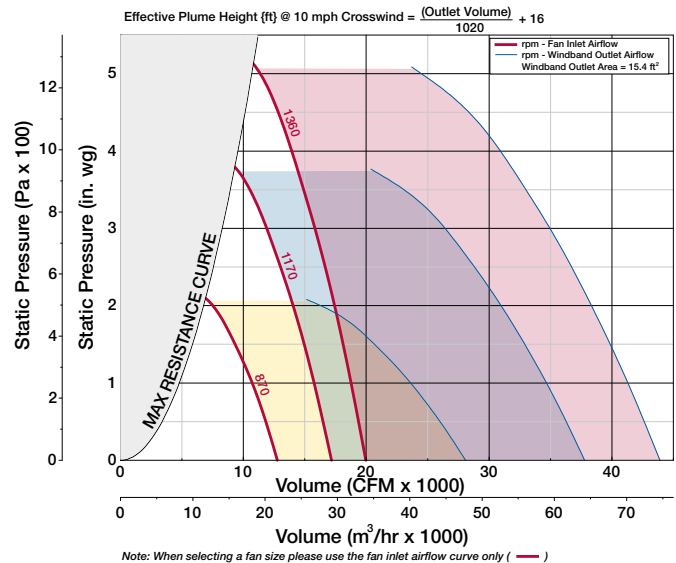
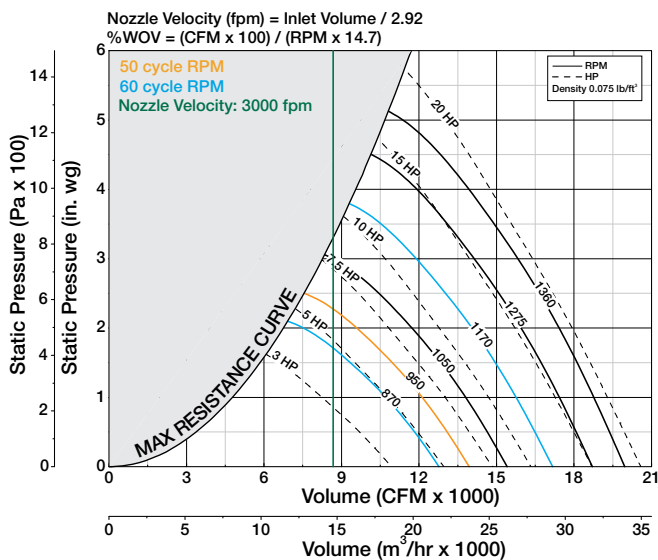

Performance certified is for installation Type A: Free inlet, Free outlet. Power rating (Bhp) does not include transmission losses. Performance ratings do not include the effects of cross winds. Performance ratings do not include the effects of appurtenances (accessories).

Inlet Airflow

85% Wheel Width

Outlet Airflow

AIR DATA

LV
Low Velocity

MV
Medium Velocity

HV
High Velocity

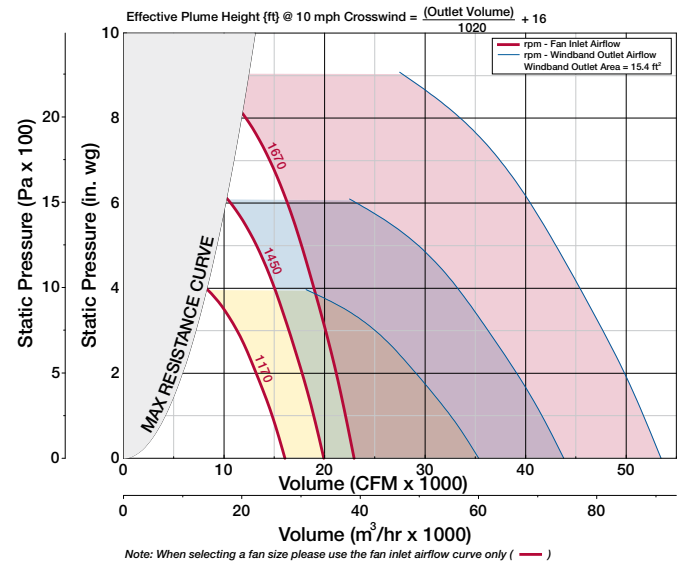
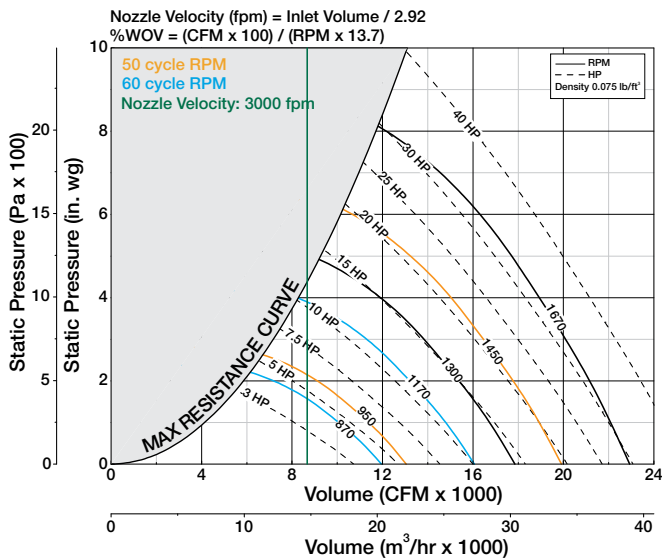
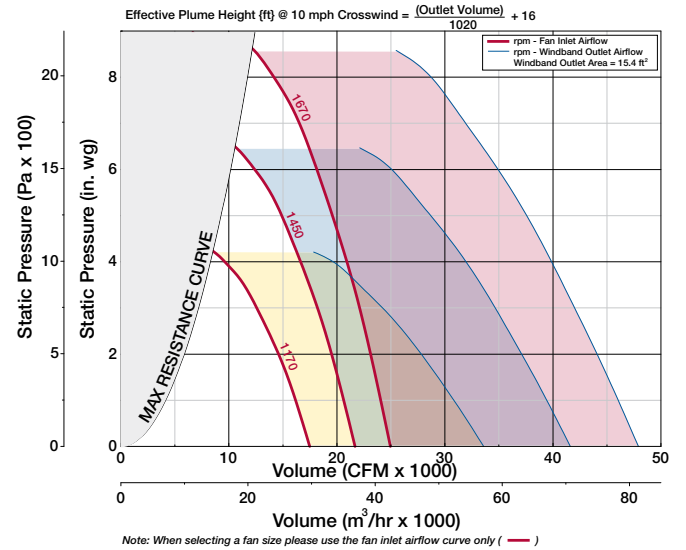
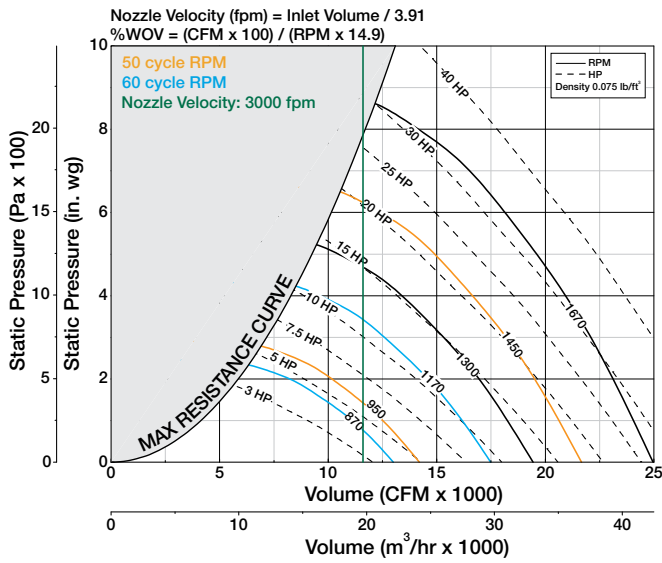
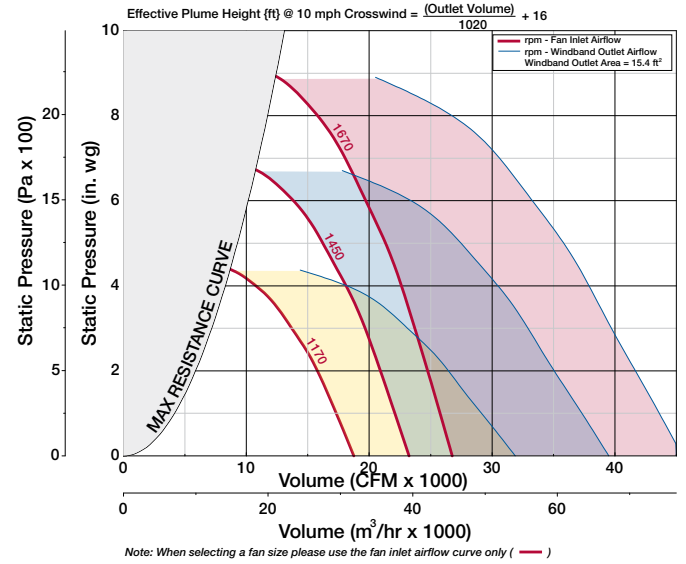
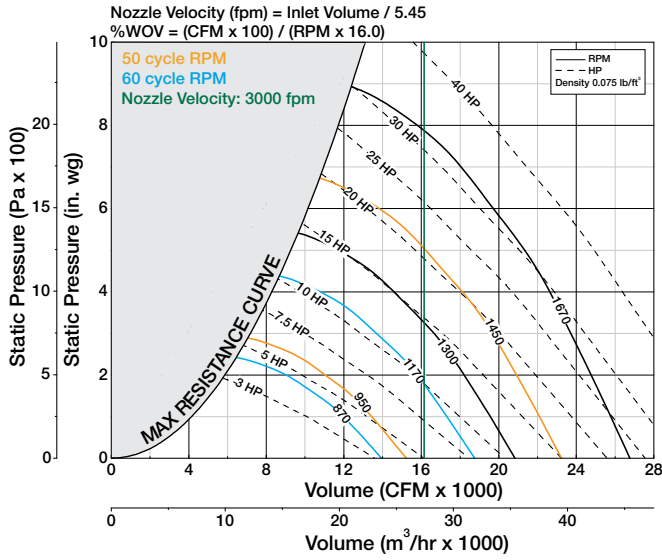

Performance certified is for installation Type A: Free inlet, Free outlet. Power rating (Bhp) does not include transmission losses. Performance ratings do not include the effects of cross winds. Performance ratings do not include the effects of appurtenances (accessories).

Inlet Airflow

70% Wheel Width

Outlet Airflow

LV
Low Velocity

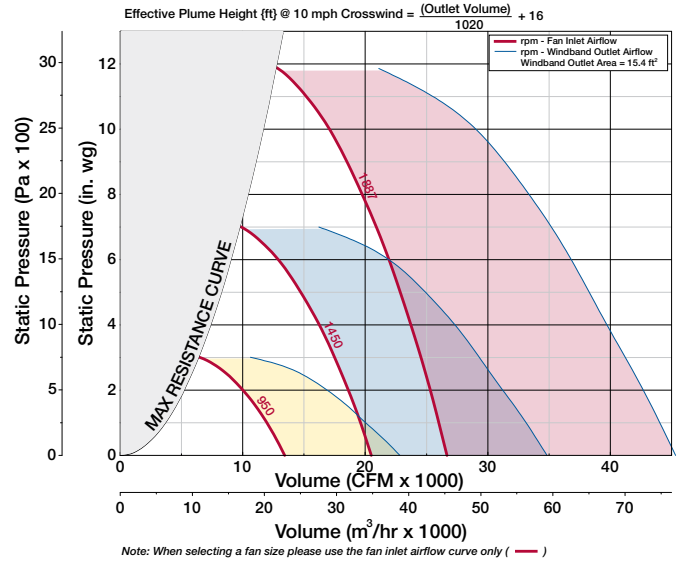
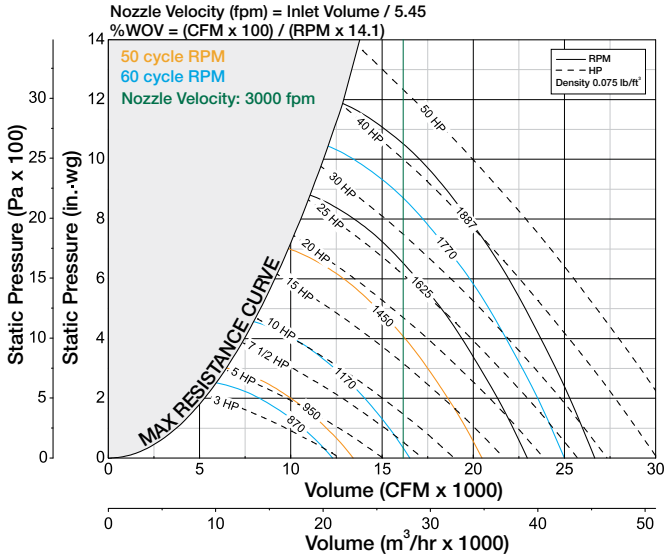

MV
Medium Velocity

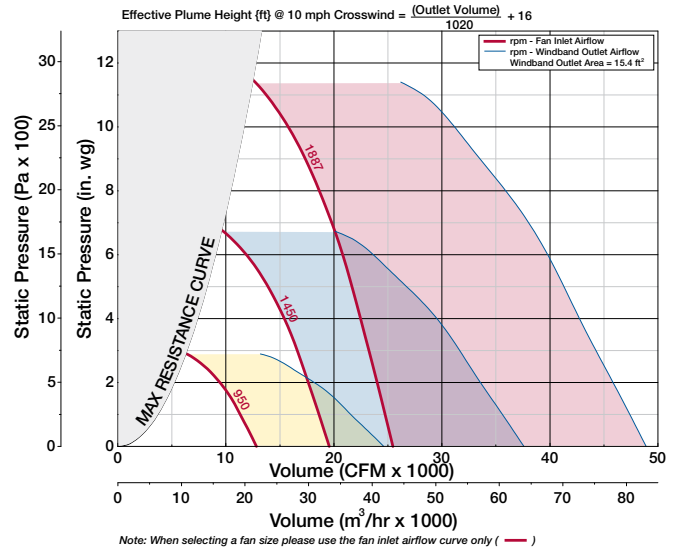
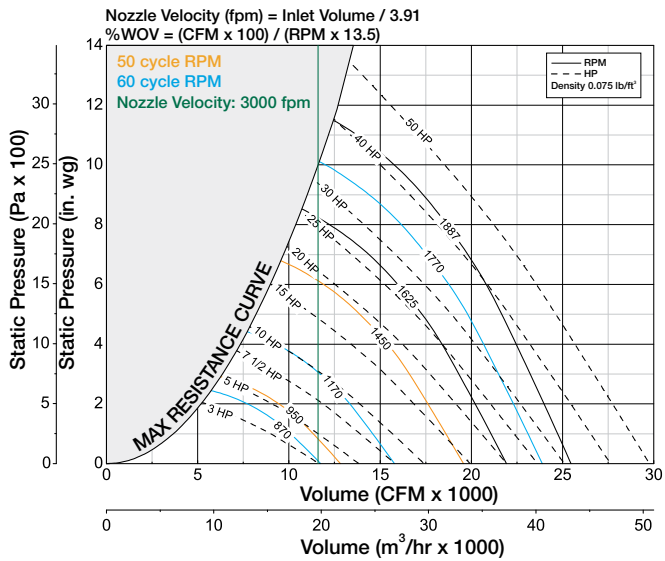

HV
High Velocity

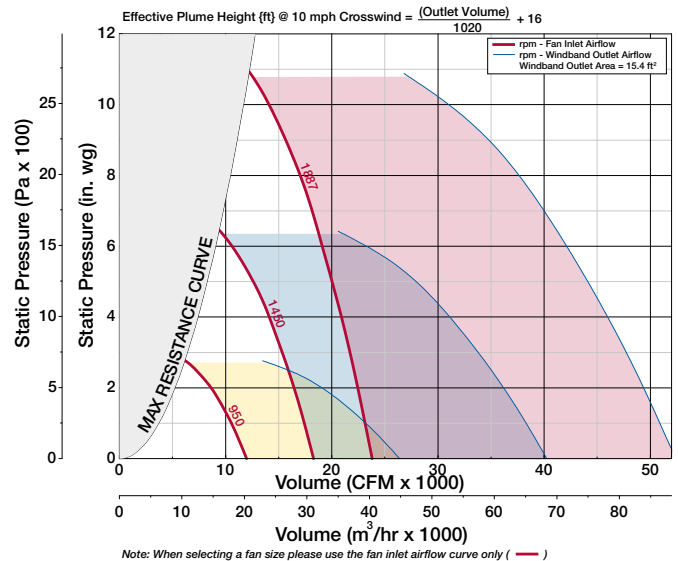
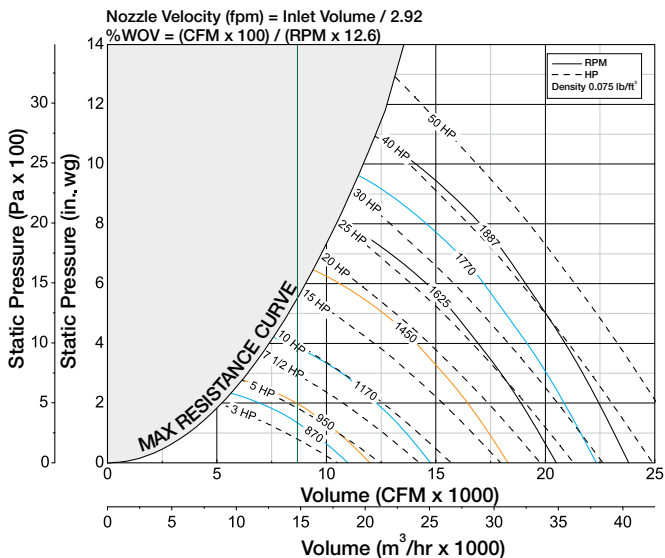

Performance certified is for installation Type A: Free inlet, Free outlet. Power rating (Bhp) does not include transmission losses. Performance ratings do not include the effects of cross winds. Performance ratings do not include the effects of appurtenances (accessories).

50% Wheel Width

Inlet Airflow

Outlet Airflow

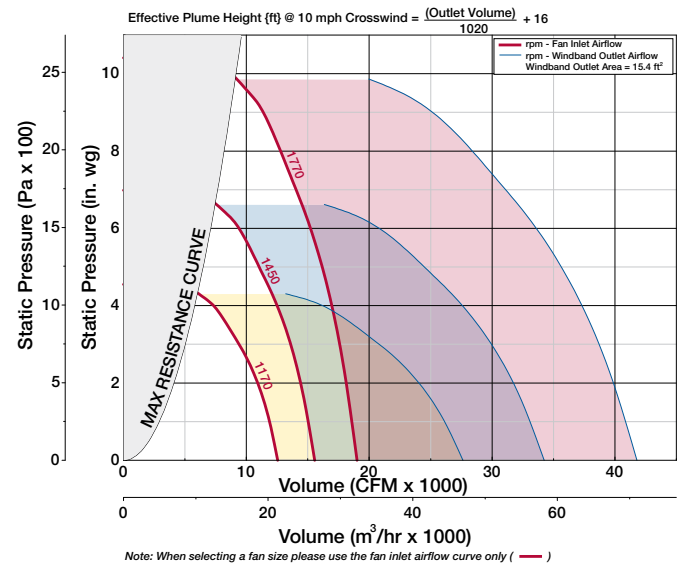
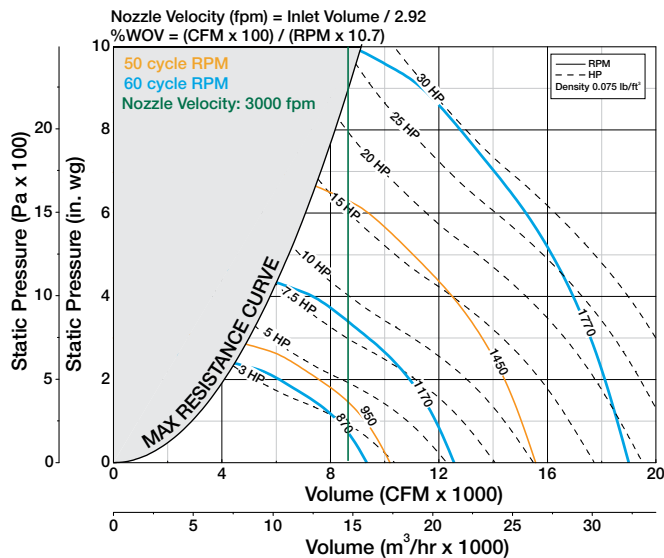
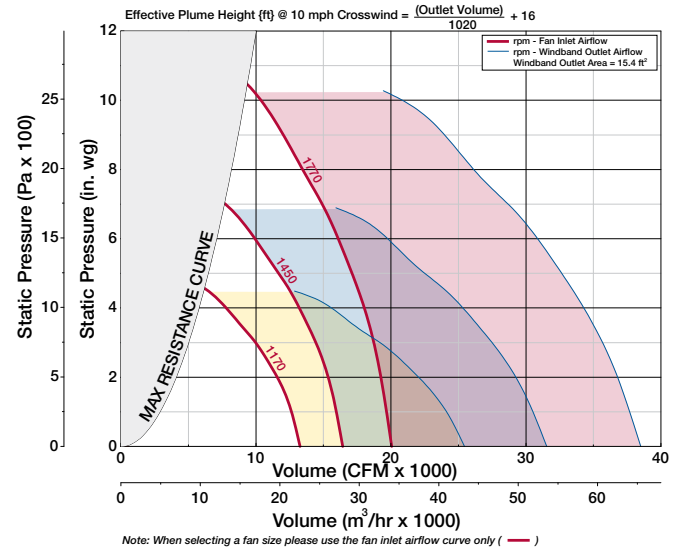
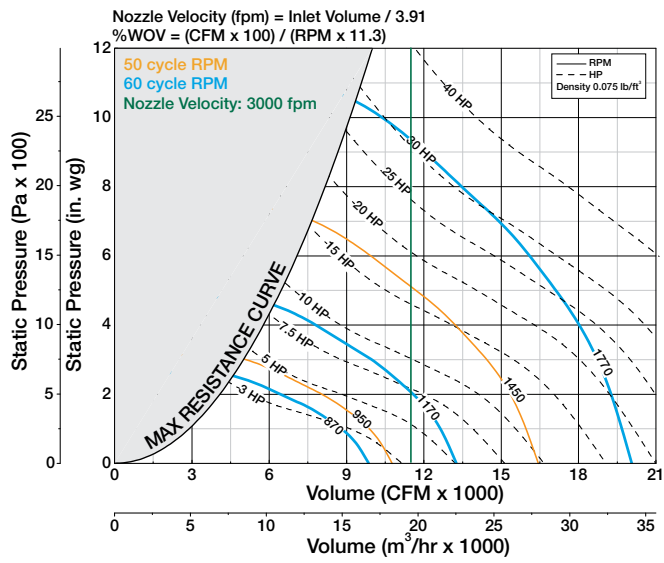
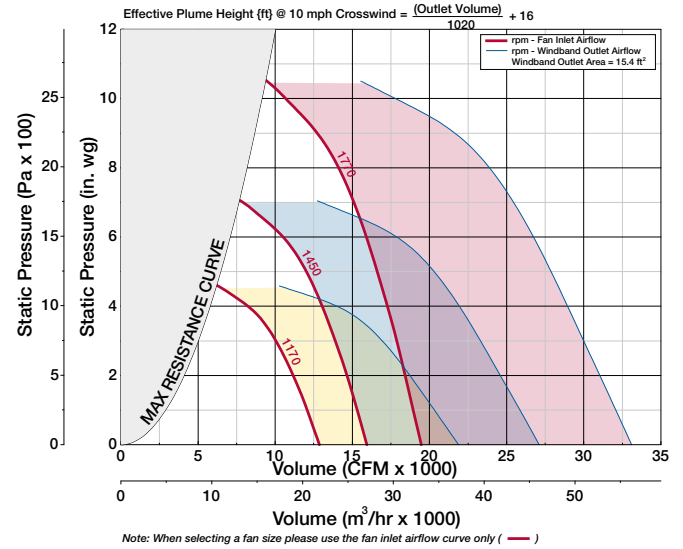
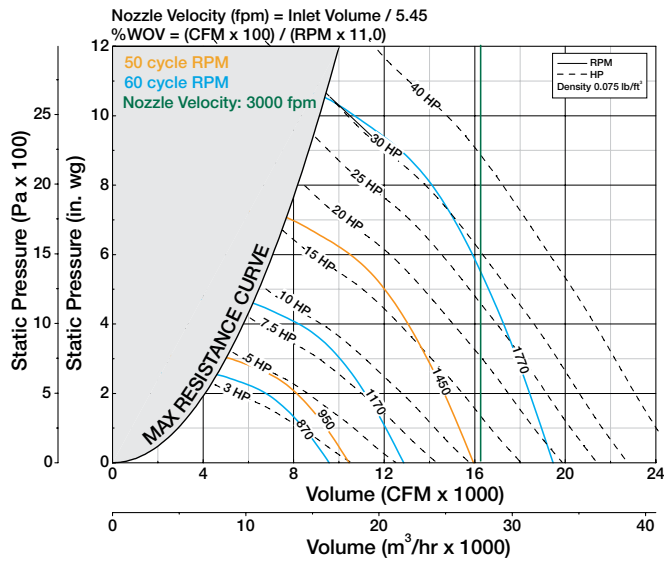

Performance certified is for installation Type A: Free inlet, Free outlet. Power rating (Bhp) does not include transmission losses. Performance ratings do not include the effects of cross winds. Performance ratings do not include the effects of appurtenances (accessories).

AIR DATA

LV
Low Velocity

MV
Medium Velocity

HV
High Velocity

AIR DATA

Inlet Airflow

100% Wheel Width

Outlet Airflow

LV
Low Velocity

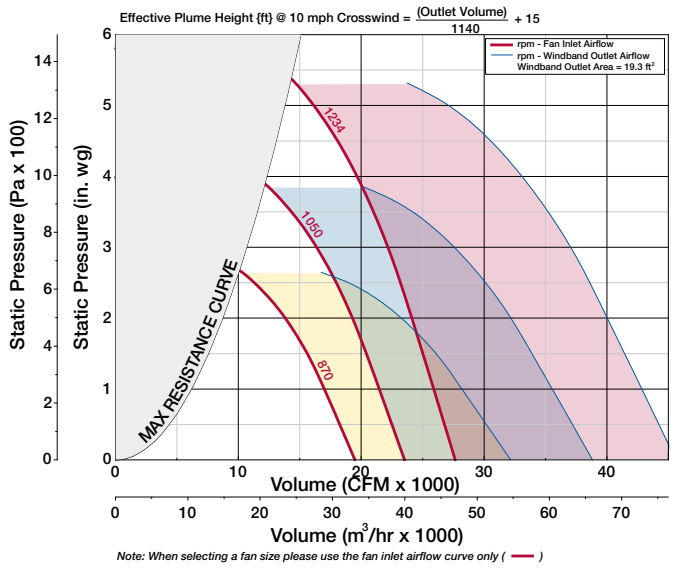
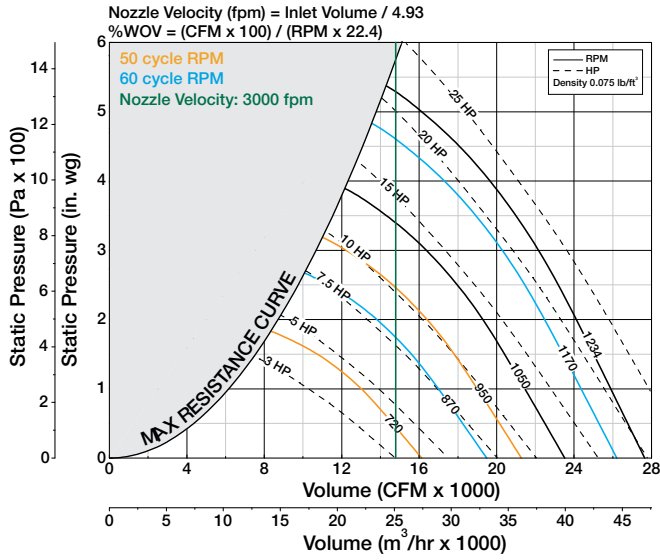

MV
Medium Velocity

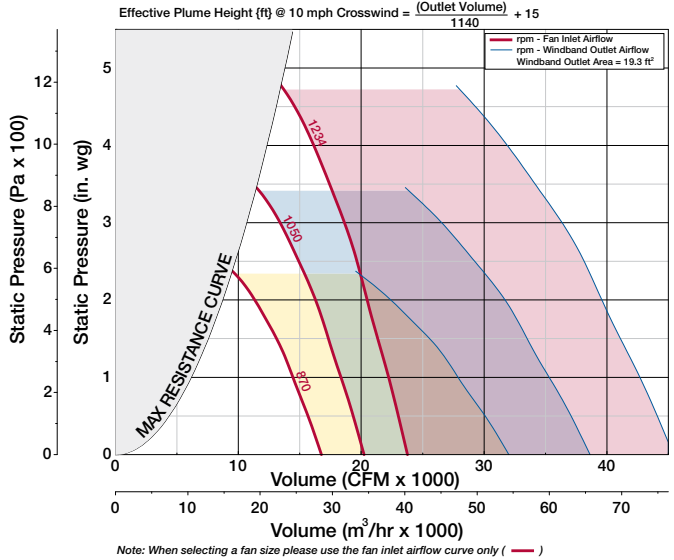
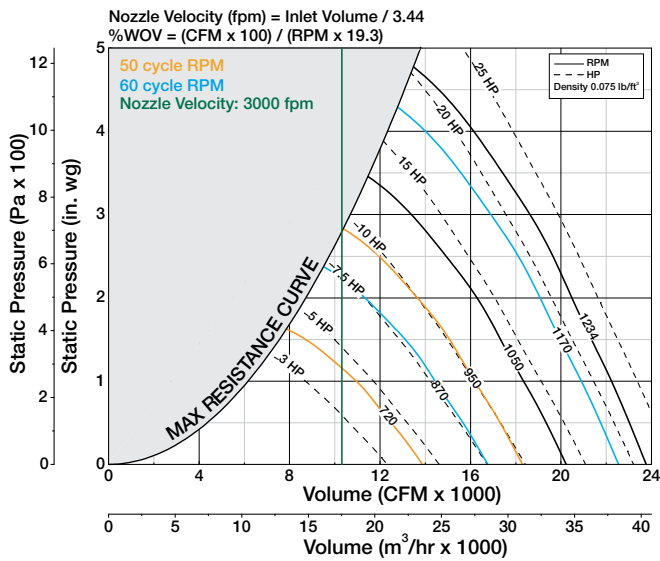

HV
High Velocity

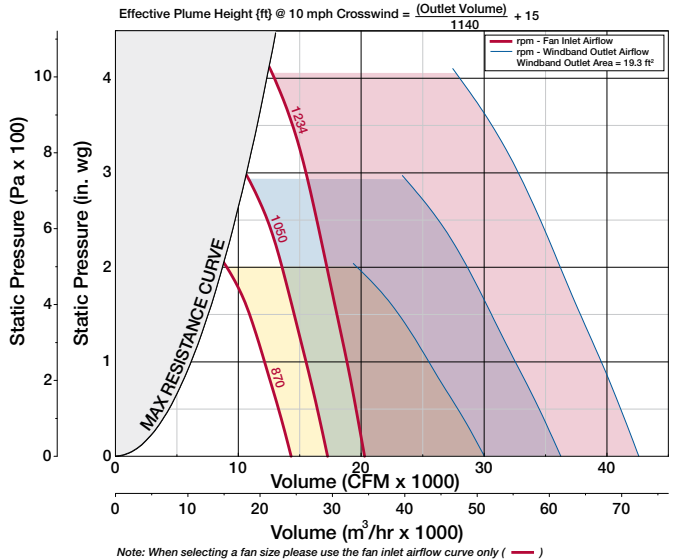
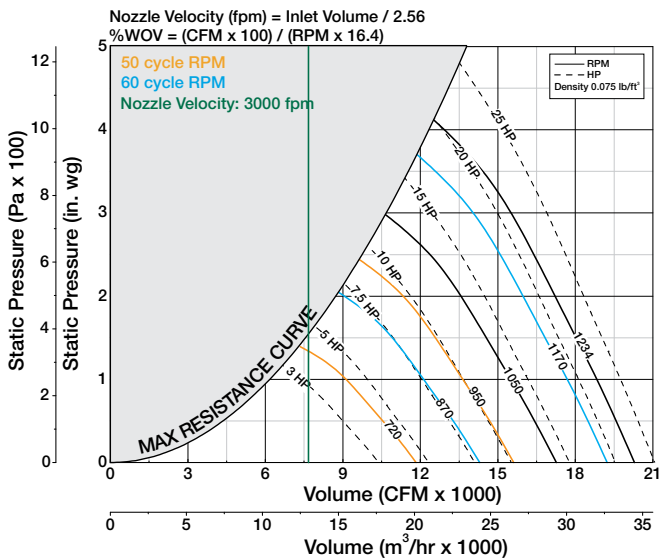

Performance certified is for installation Type A: Free inlet, Free outlet. Power rating (Bhp) does not include transmission losses. Performance ratings do not include the effects of cross winds. Performance ratings do not include the effects of appurtenances (accessories).

Inlet Airflow 85% Wheel Width Outlet Airflow

AIR DATA
LV
Low Velocity

MV
Medium Velocity

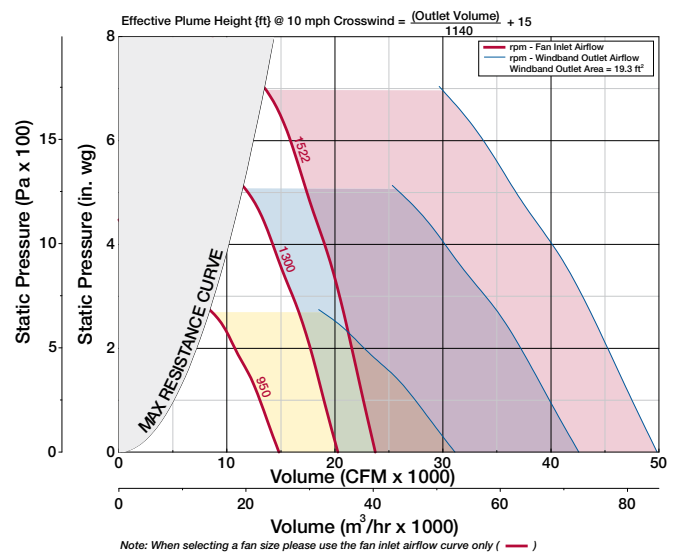
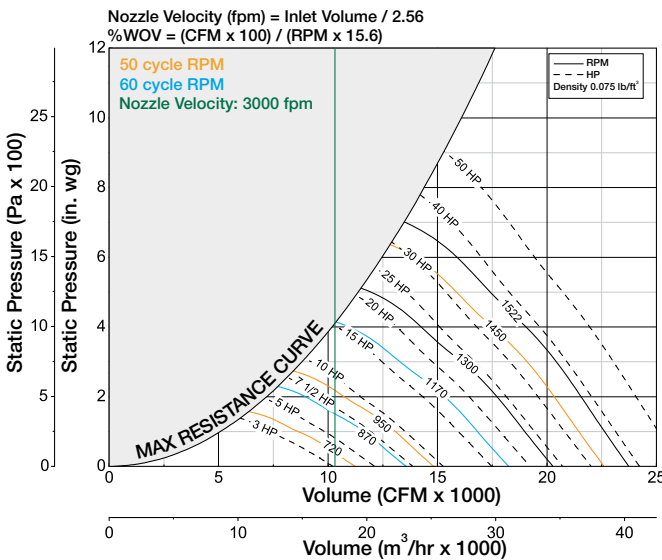
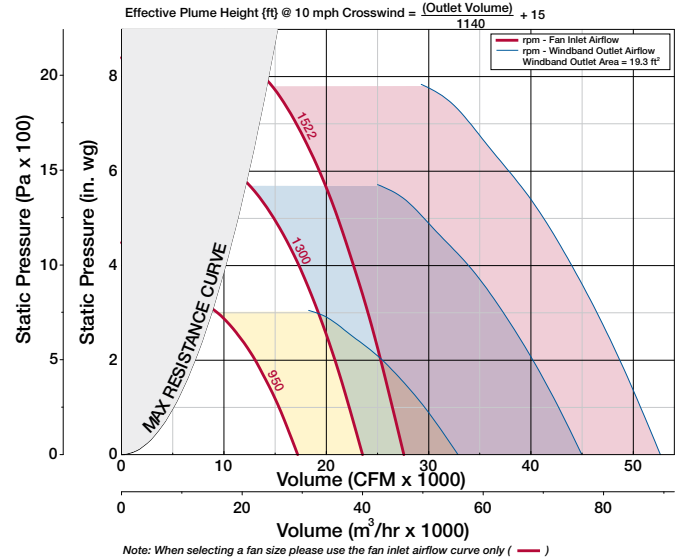
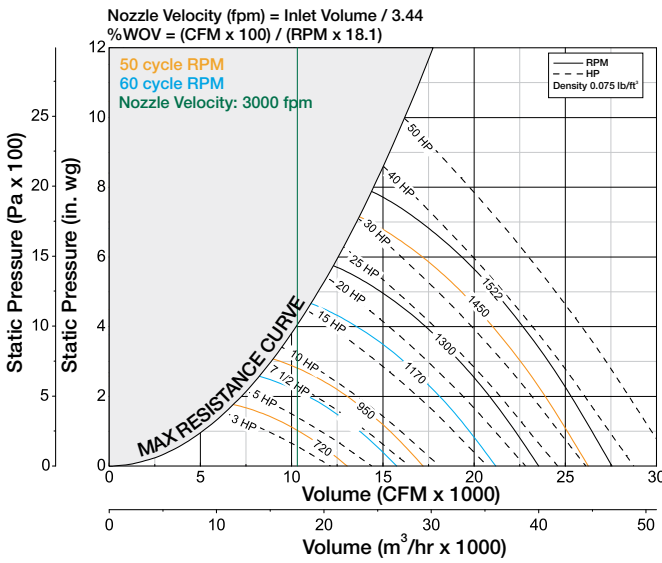
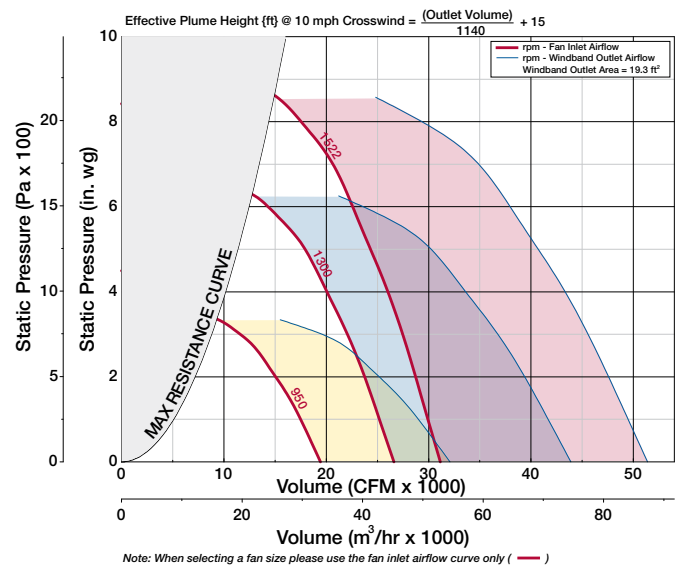
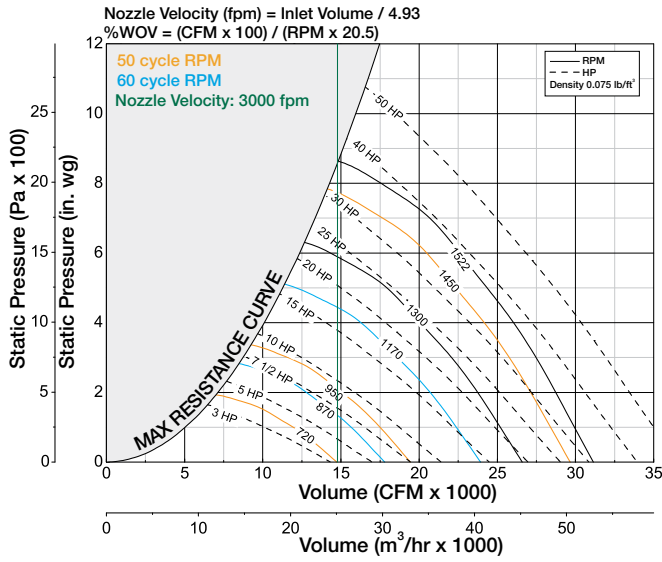
HV
High Velocity

Performance certified is for installation Type A: Free inlet, Free outlet. Power rating (Bhp) does not include transmission losses. Performance ratings do not include the effects of cross winds. Performance ratings do not include the effects of appurtenances (accessories).

AIR DATA

Inlet Airflow

70% Wheel Width

Outlet Airflow

Nozzle Velocity (fpm) = Inlet Volume / 4.93
 %WOV = (CFM x 100) / (RPM x 18.1)

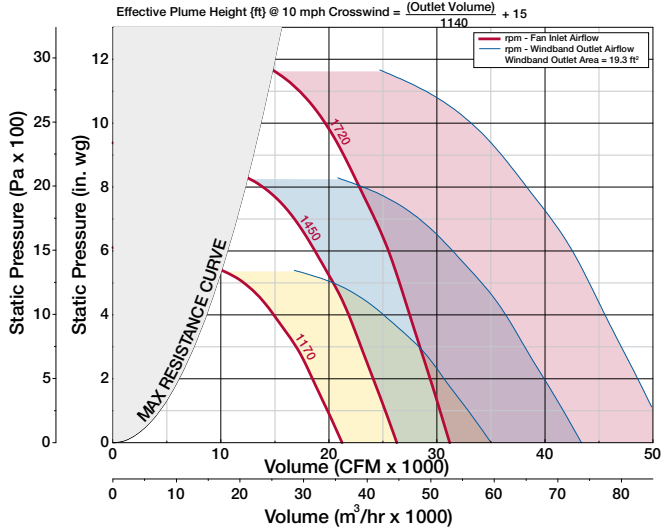
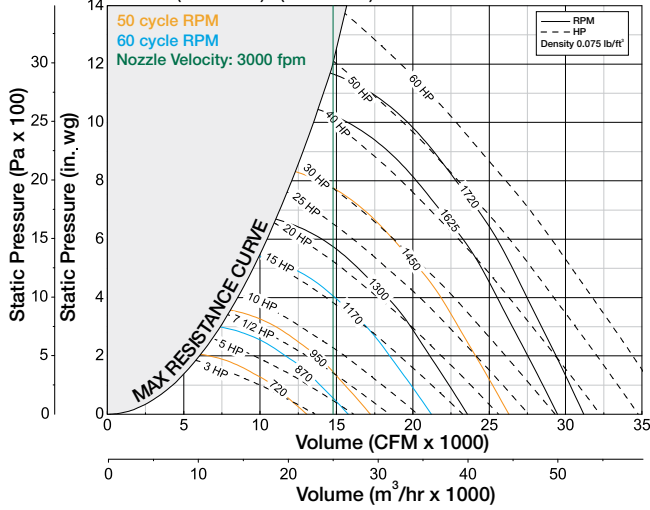

Nozzle Velocity (fpm) = Inlet Volume / 3.44
 %WOV = (CFM x 100) / (RPM x 16.6)

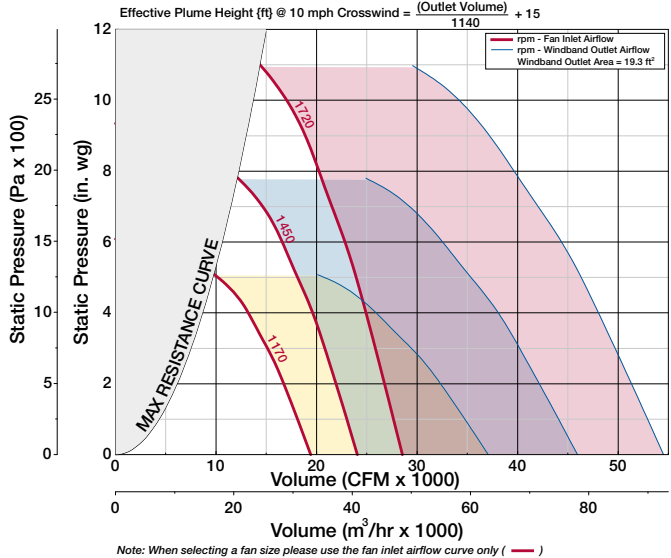
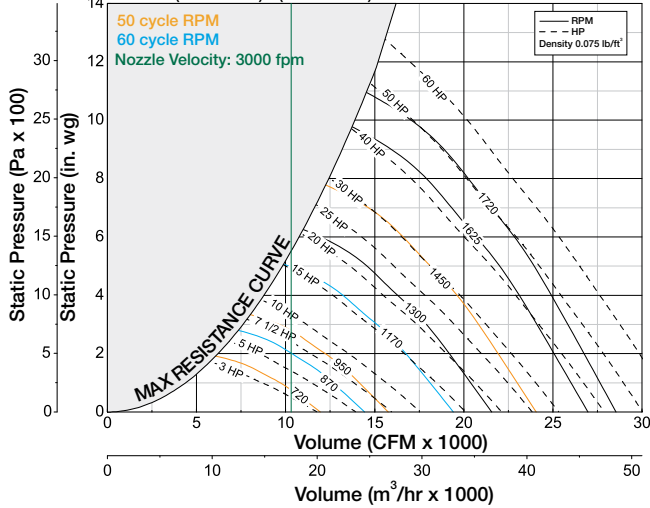

Nozzle Velocity (fpm) = Inlet Volume / 2.56
 %WOV = (CFM x 100) / (RPM x 14.6)

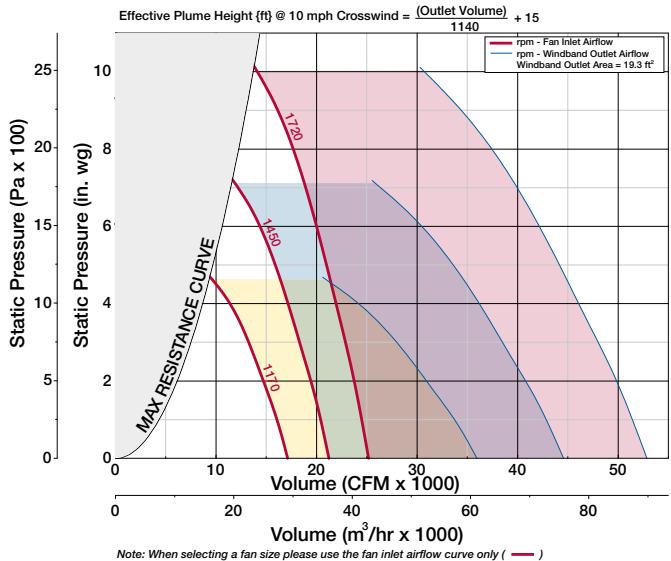
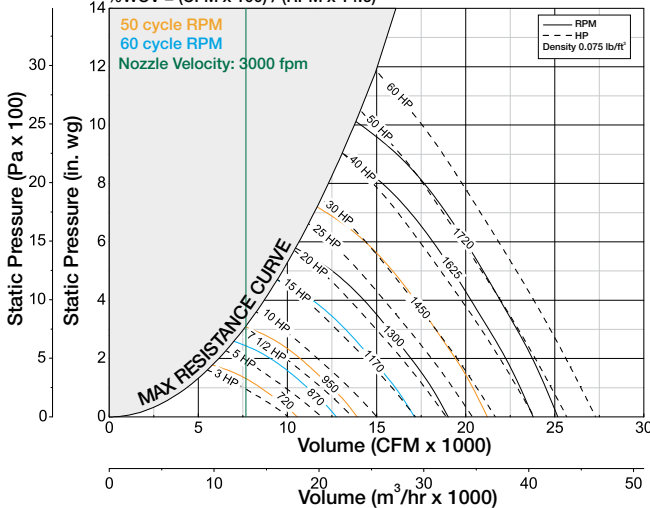

Performance certified is for installation Type A: Free inlet, Free outlet. Power rating (Bhp) does not include transmission losses. Performance ratings do not include the effects of cross winds. Performance ratings do not include the effects of appurtenances (accessories).

Inlet Airflow 50% Wheel Width Outlet Airflow

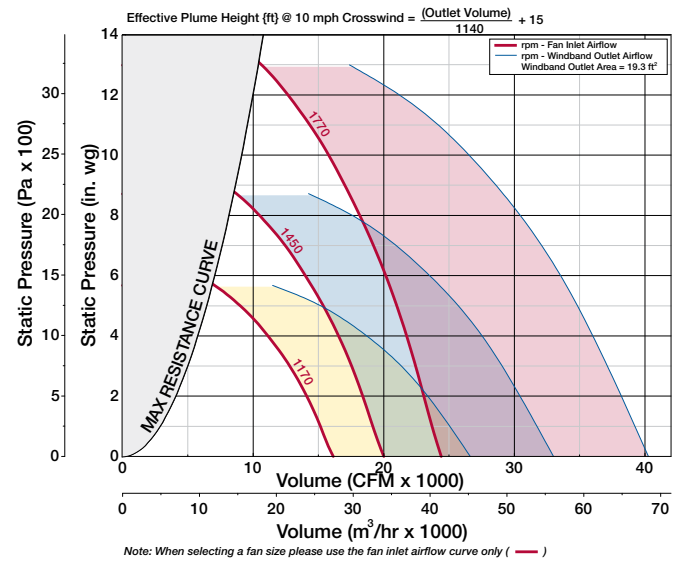
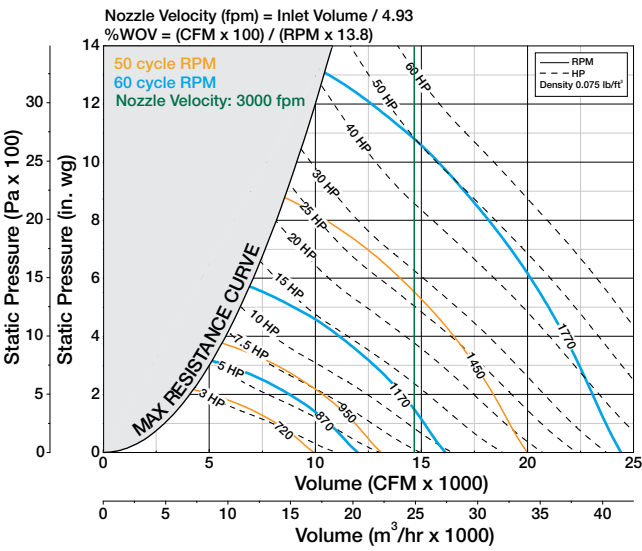
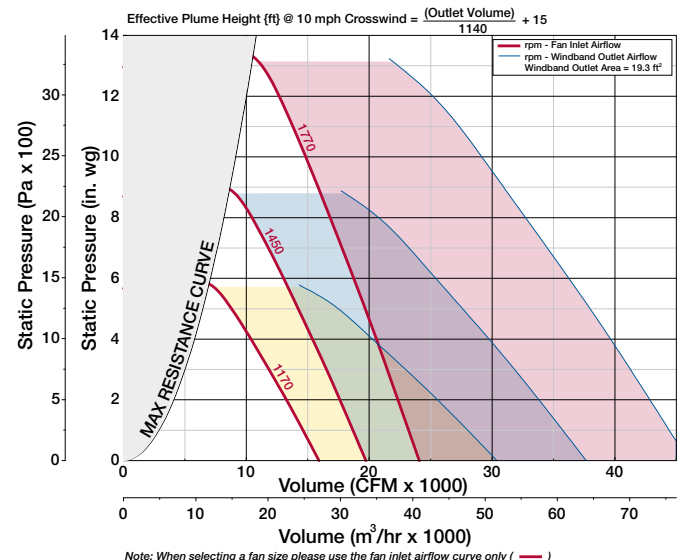
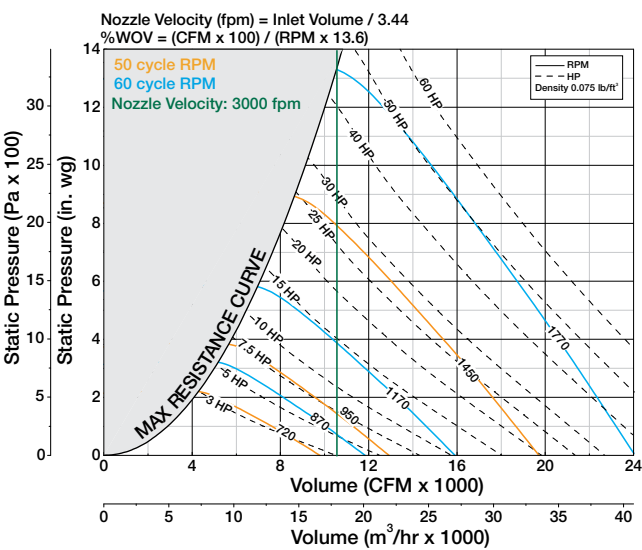
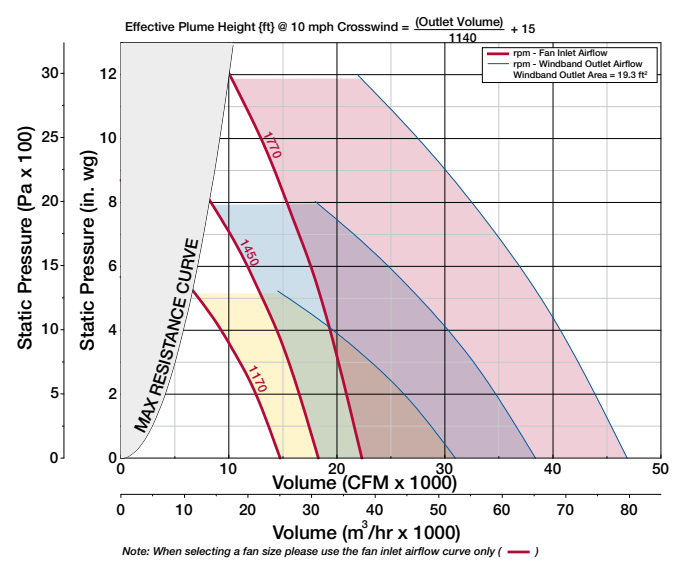
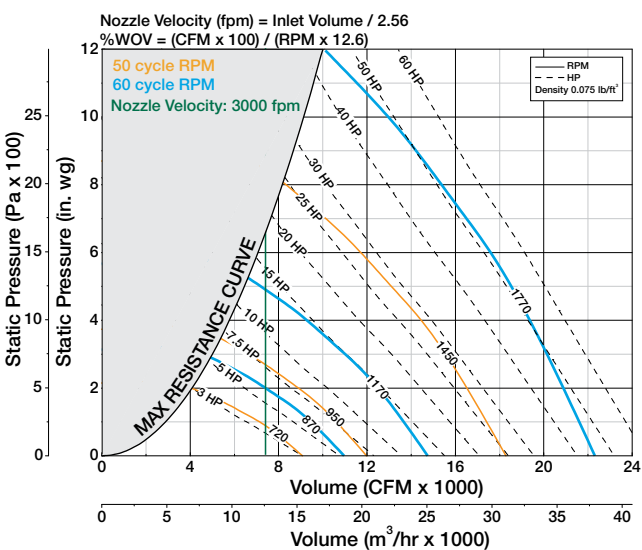
AIR DATA

LV
Low Velocity

MV
Medium Velocity

HV
High Velocity

Performance certified is for installation Type A: Free inlet, Free outlet. Power rating (Bhp) does not include transmission losses. Performance ratings do not include the effects of cross winds. Performance ratings do not include the effects of appurtenances (accessories).

Inlet Airflow

100% Wheel Width

Outlet Airflow

LV
Low Velocity

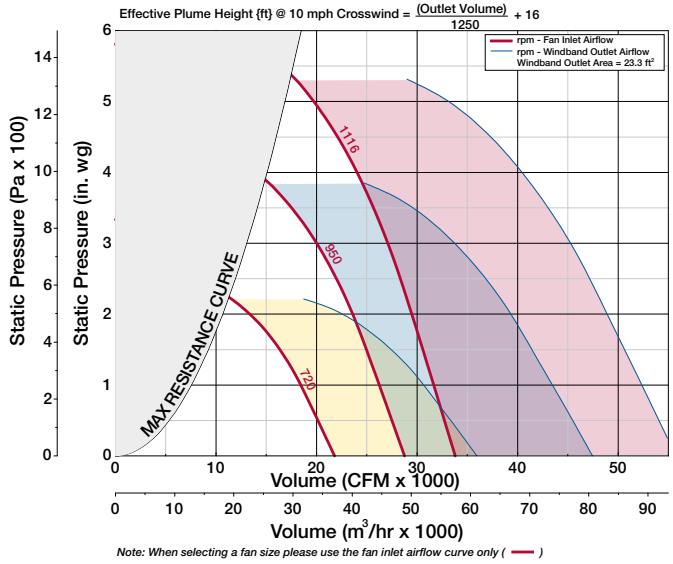
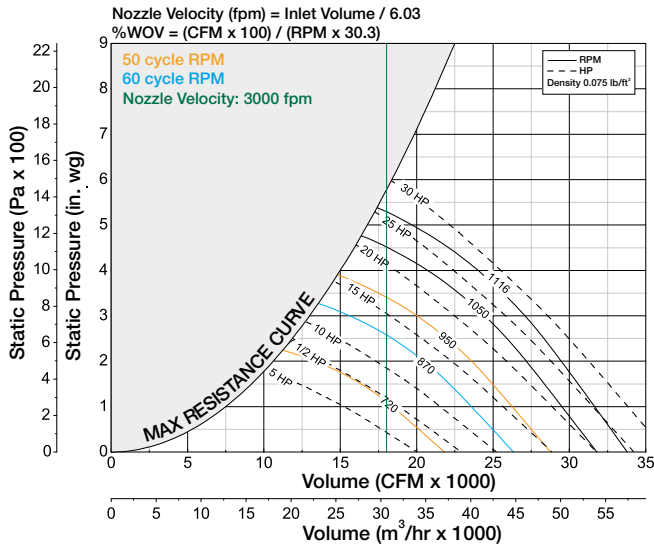

MV
Medium Velocity

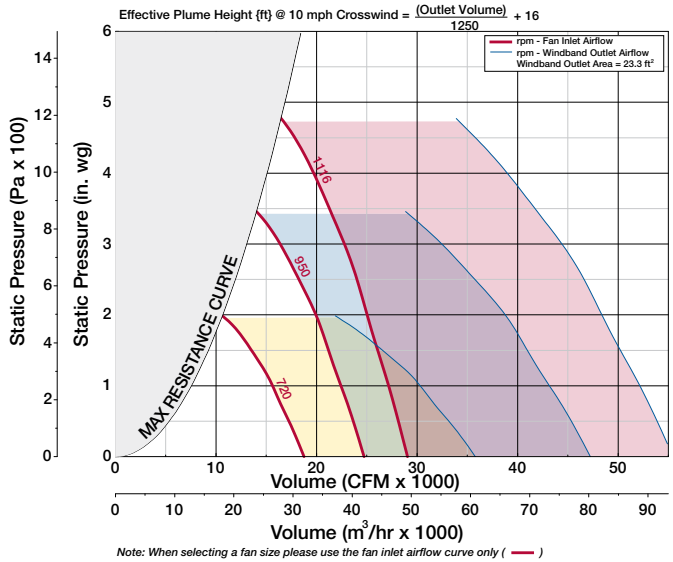
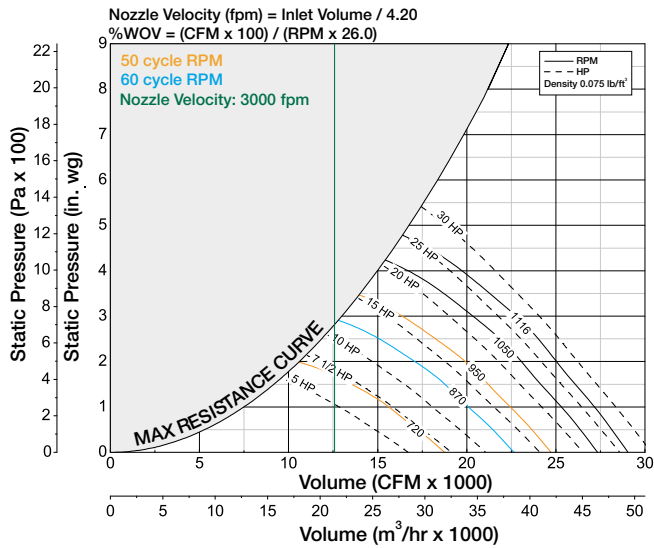

HV
High Velocity

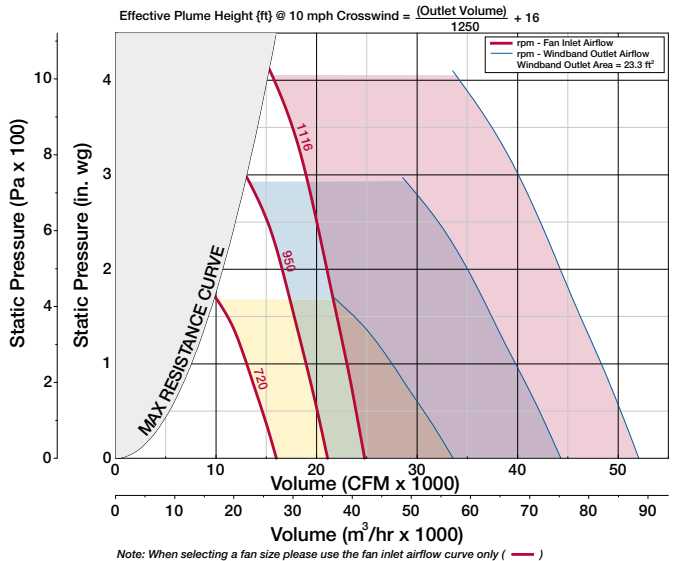
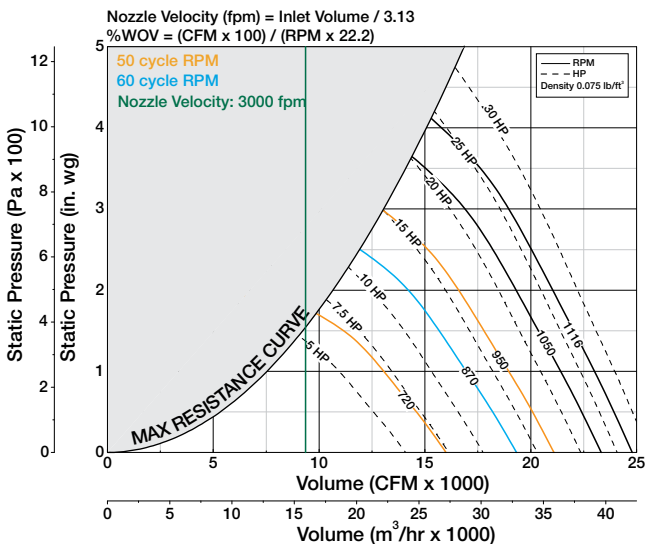

Performance certified is for installation Type A: Free inlet, Free outlet. Power rating (Bhp) does not include transmission losses. Performance ratings do not include the effects of cross winds. Performance ratings do not include the effects of appurtenances (accessories).

Inlet Airflow

85% Wheel Width

Outlet Airflow

AIR DATA

Low Velocity LV

Medium Velocity MV

High Velocity HV

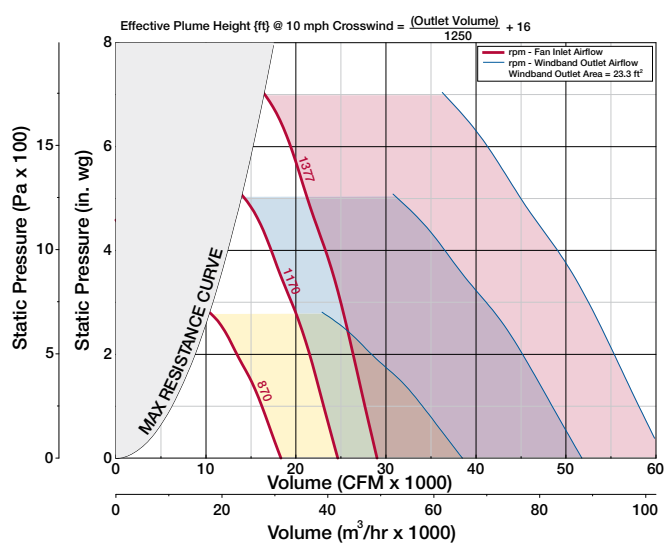
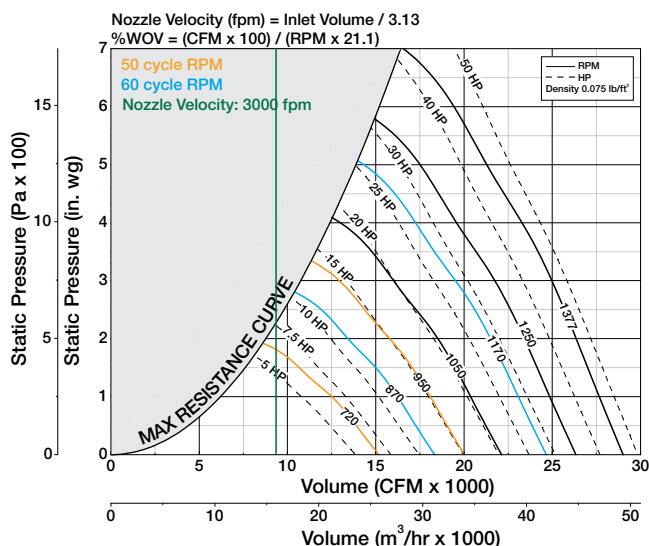
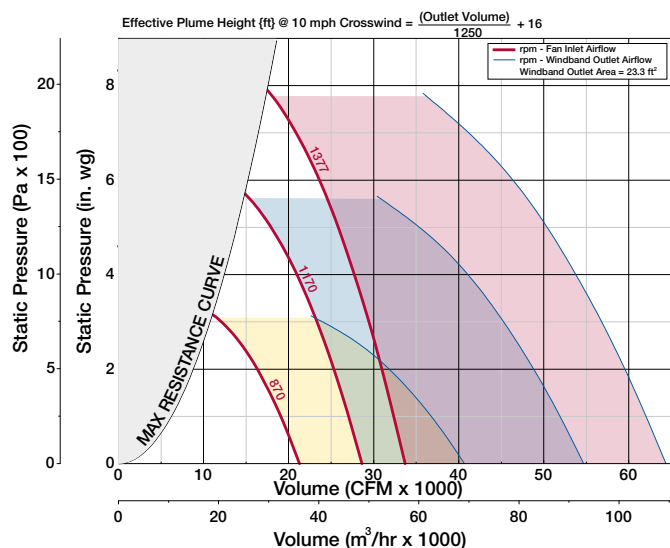
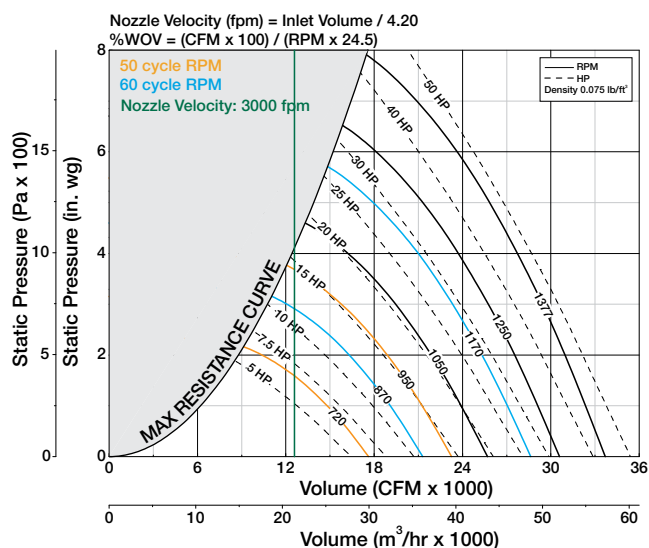
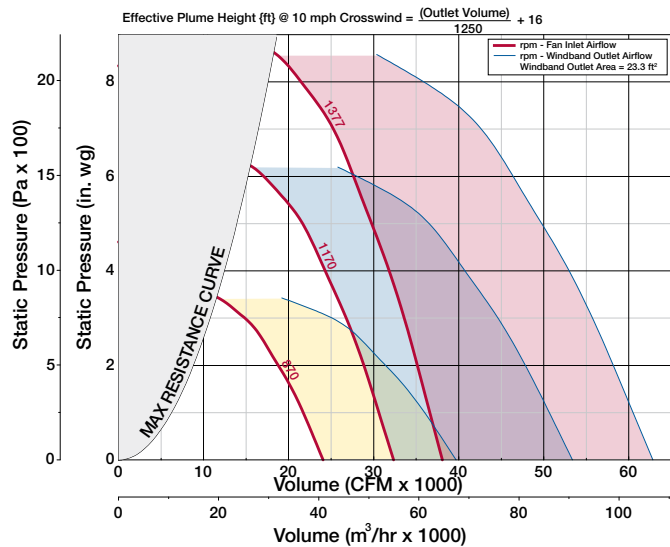
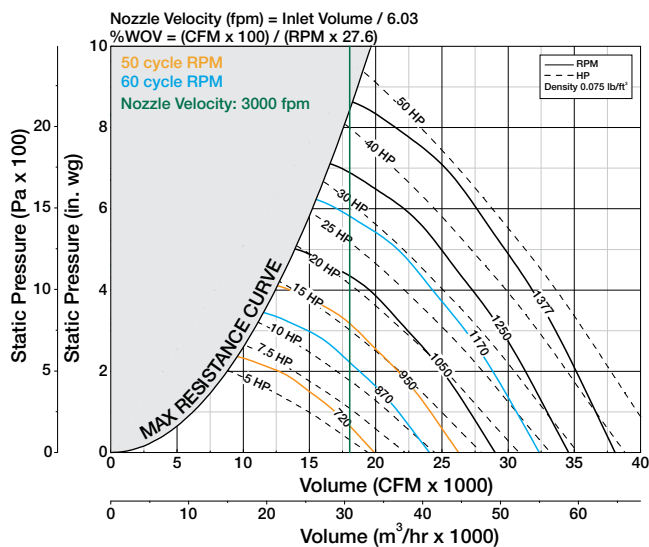

Performance certified is for installation Type A: Free inlet, Free outlet. Power rating (Bhp) does not include transmission losses. Performance ratings do not include the effects of cross winds. Performance ratings do not include the effects of appurtenances (accessories).

AIR DATA

Inlet Airflow

70% Wheel Width

Outlet Airflow

LV
Low Velocity

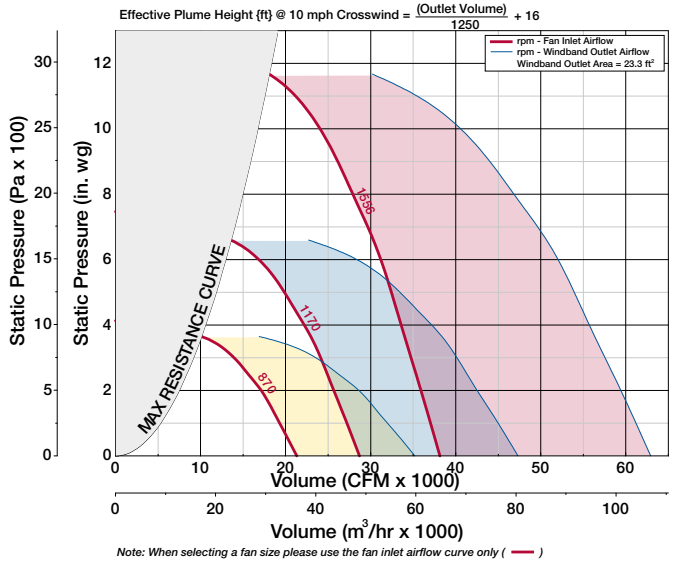
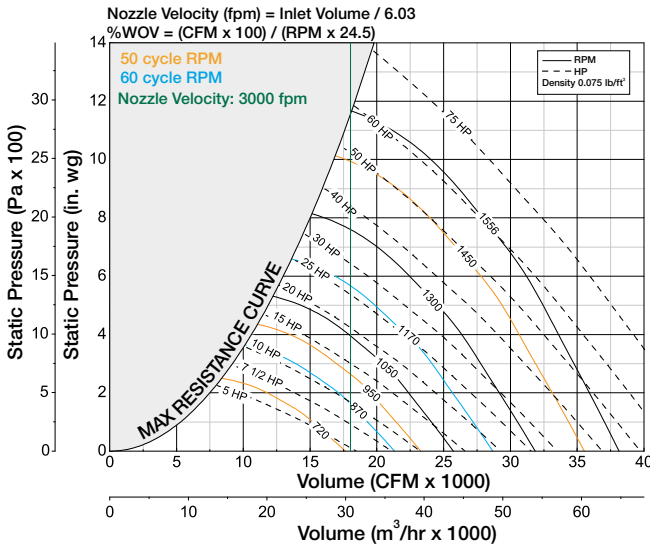

MV
Medium Velocity

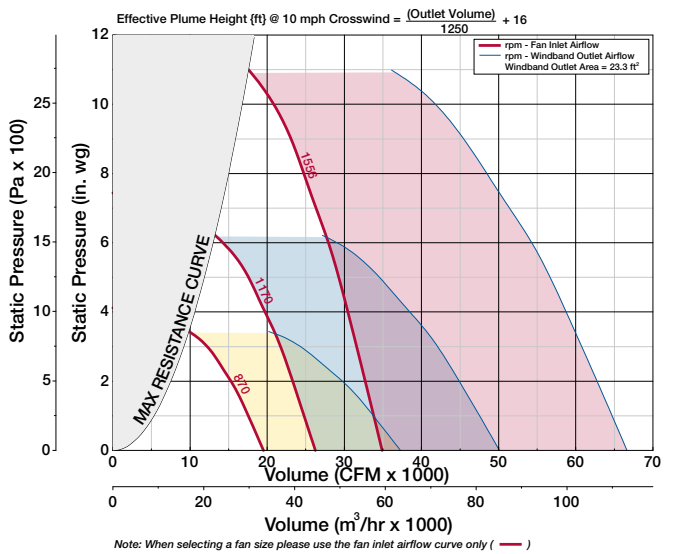
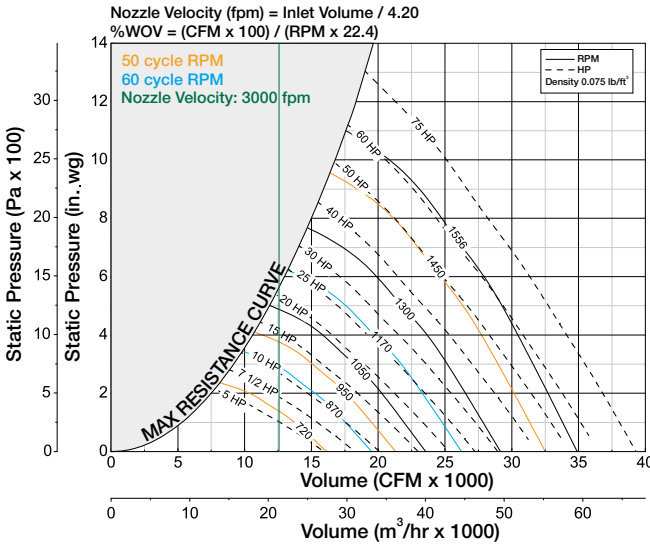

HV
High Velocity

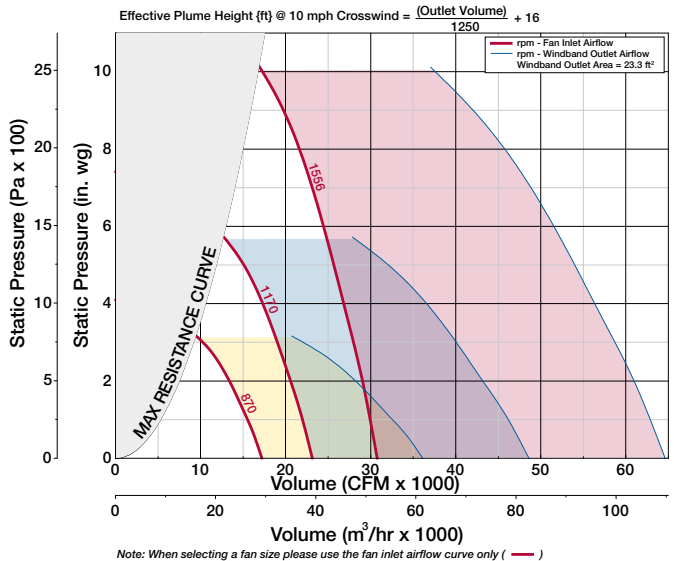
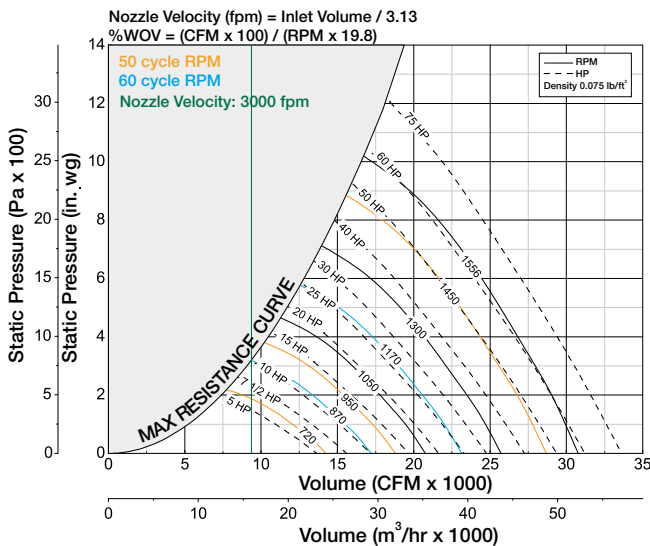

Performance certified is for installation Type A: Free inlet, Free outlet. Power rating (Bhp) does not include transmission losses. Performance ratings do not include the effects of cross winds. Performance ratings do not include the effects of appurtenances (accessories).

Inlet Airflow

50% Wheel Width

Outlet Airflow

AIR DATA

LV
Low Velocity

MV
Medium Velocity

HV
High Velocity

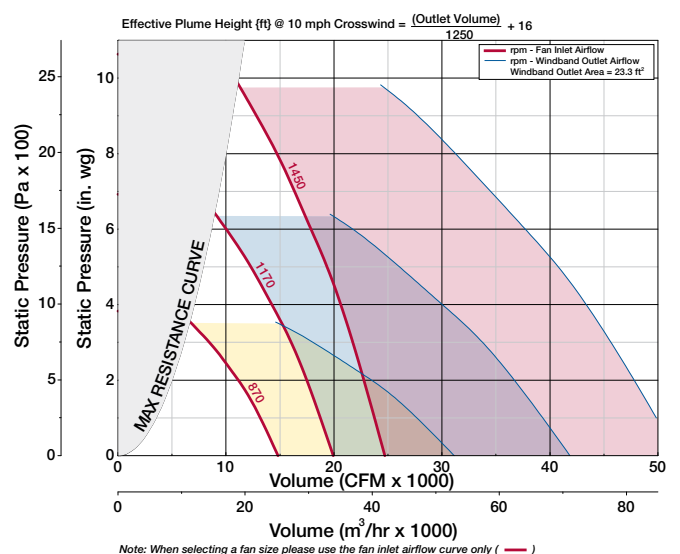
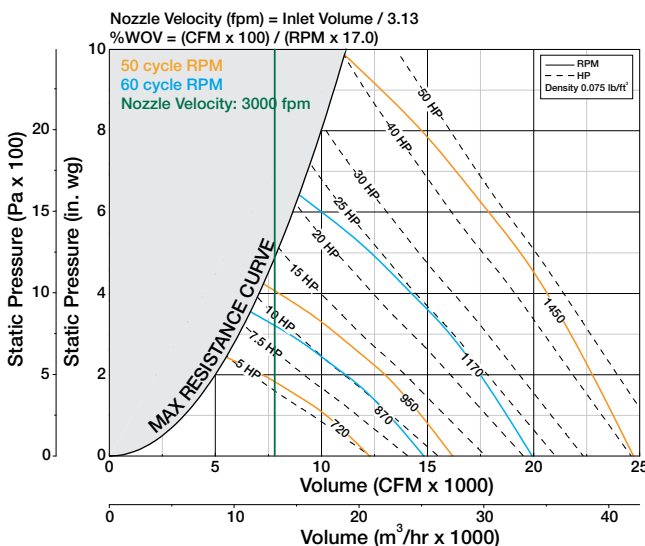
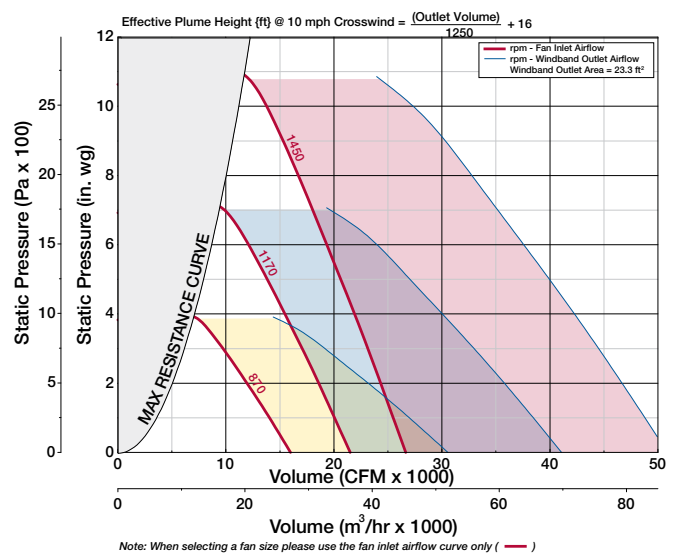
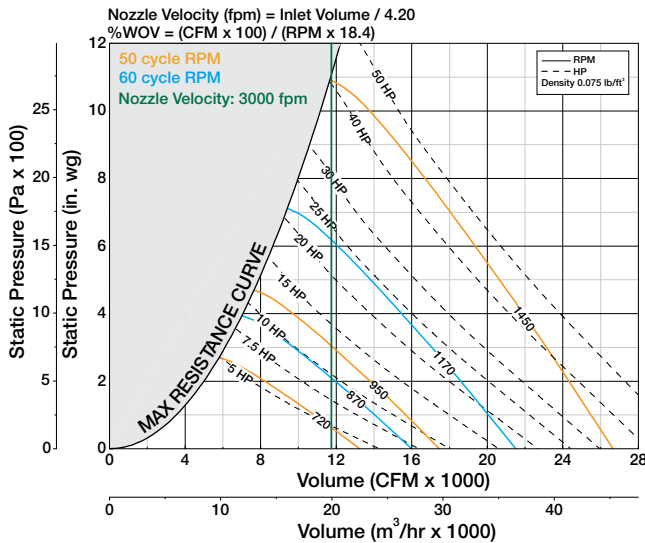
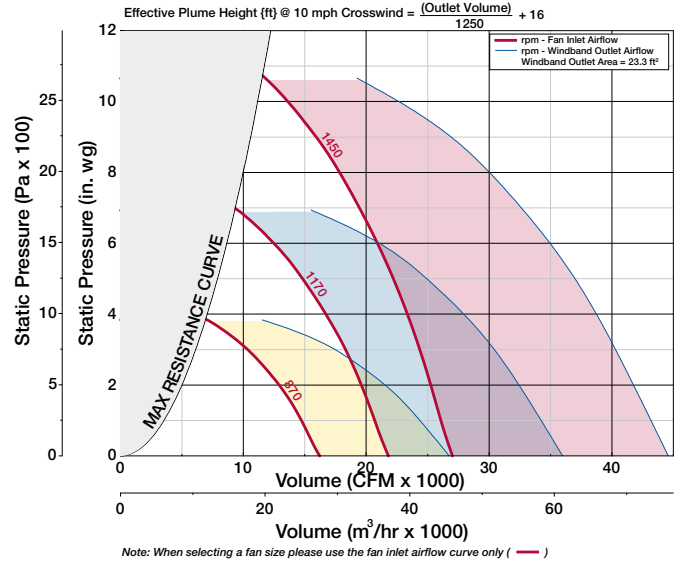
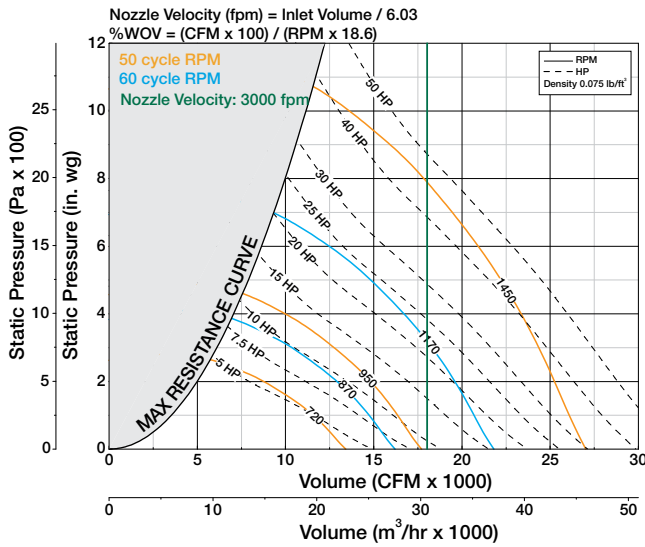

Performance certified is for installation Type A: Free inlet, Free outlet. Power rating (Bhp) does not include transmission losses. Performance ratings do not include the effects of cross winds. Performance ratings do not include the effects of appurtenances (accessories).

AIR DATA

Inlet Airflow

100% Wheel Width

Outlet Airflow

Nozzle Velocity (fpm) = Inlet Volume / 7.31
 %WOV = (CFM x 100) / (RPM x 40.4)

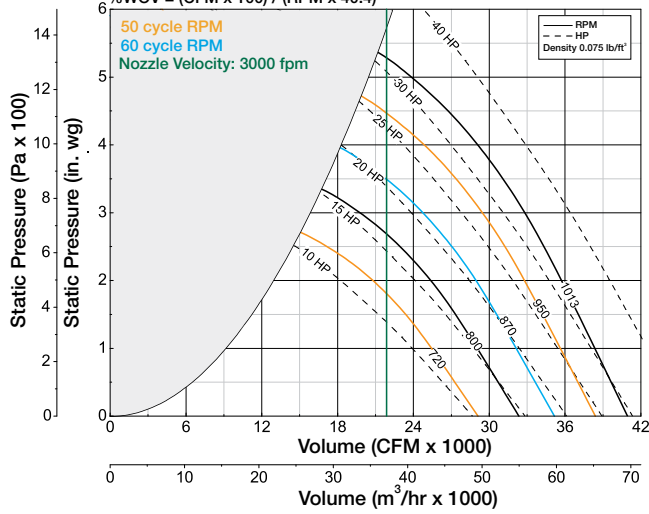

Effective Plume Height (ft) @ 10 mph Crosswind = (Outlet Volume) / 1380 + 17

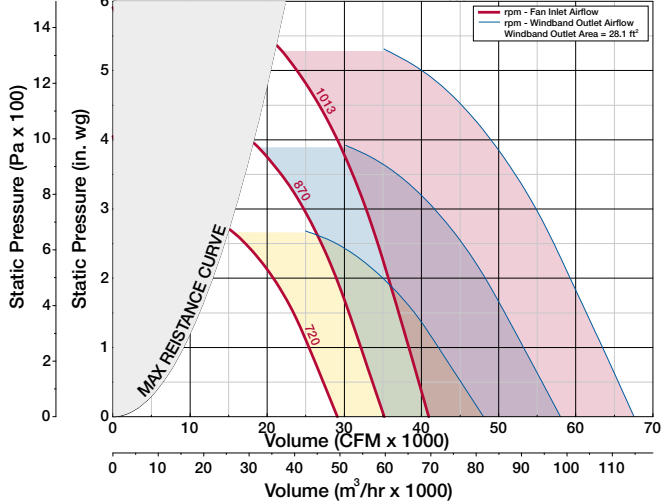

Note: When selecting a fan size please use the fan inlet airflow curve only (—)

Nozzle Velocity (fpm) = Inlet Volume / 5.10
 %WOV = (CFM x 100) / (RPM x 34.8)

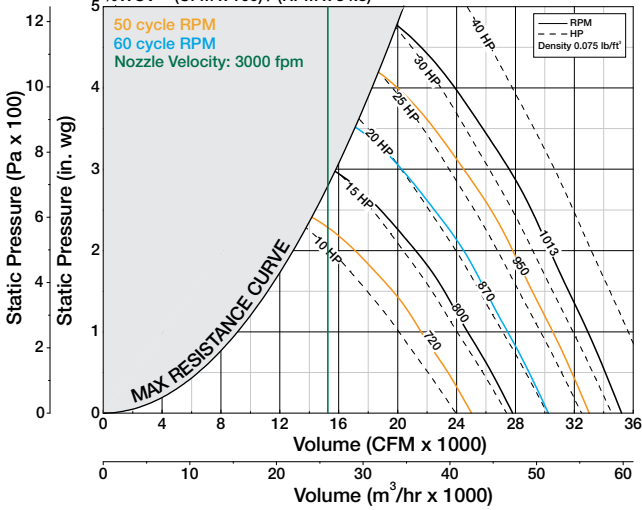

Effective Plume Height (ft) @ 10 mph Crosswind = (Outlet Volume) / 1380 + 17

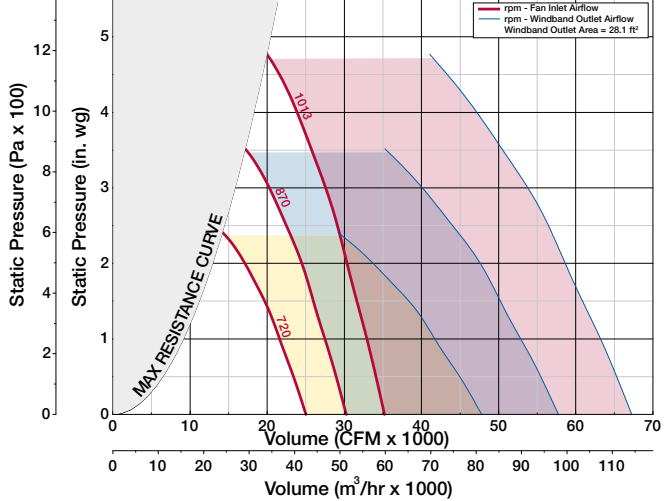

Note: When selecting a fan size please use the fan inlet airflow curve only (—)

Nozzle Velocity (fpm) = Inlet Volume / 3.79
 %WOV = (CFM x 100) / (RPM x 29.7)

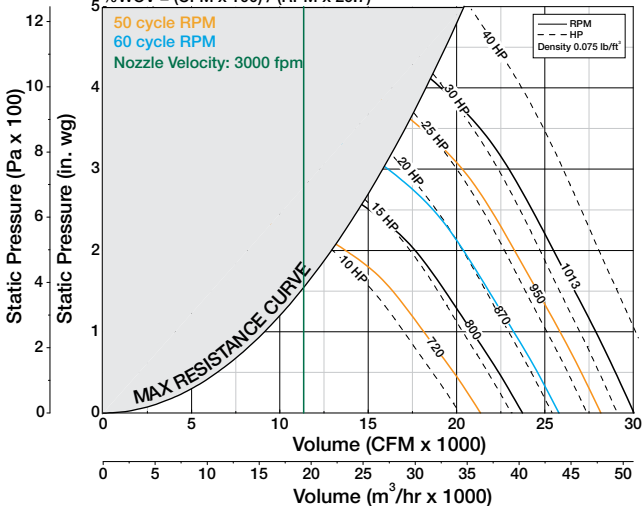

Effective Plume Height (ft) @ 10 mph Crosswind = (Outlet Volume) / 1380 + 17

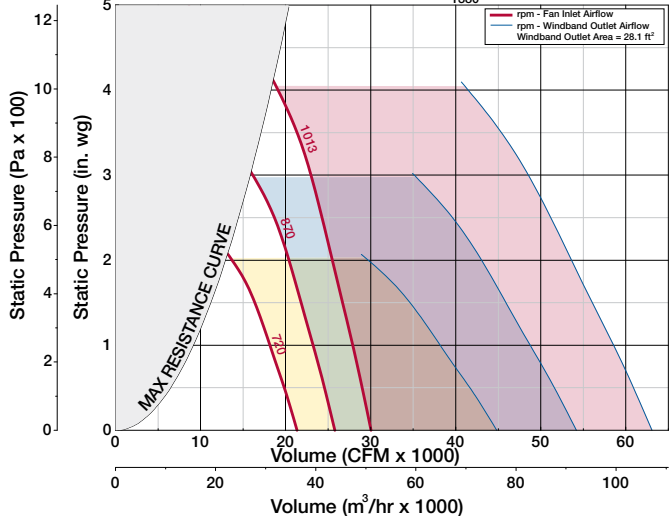

Note: When selecting a fan size please use the fan inlet airflow curve only (—)

Performance certified is for installation Type A: Free inlet, Free outlet. Power rating (Bhp) does not include transmission losses. Performance ratings do not include the effects of cross winds. Performance ratings do not include the effects of appurtenances (accessories).

Inlet Airflow

85% Wheel Width

Outlet Airflow

AIR DATA

LV
Low Velocity

MV
Medium Velocity

HV
High Velocity

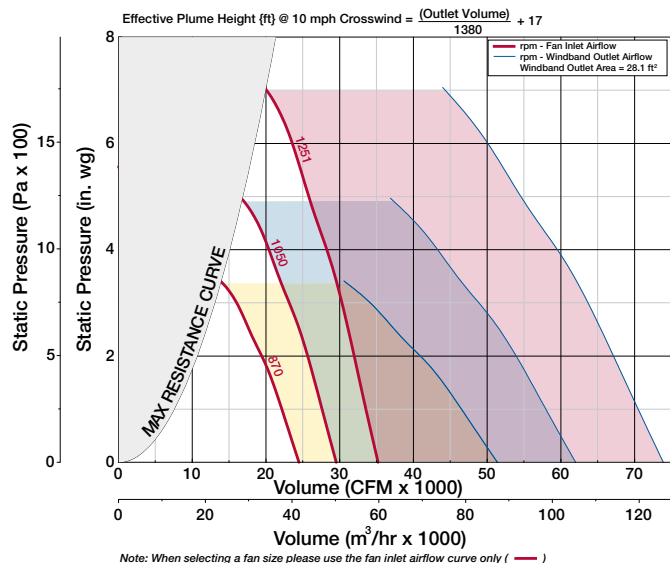
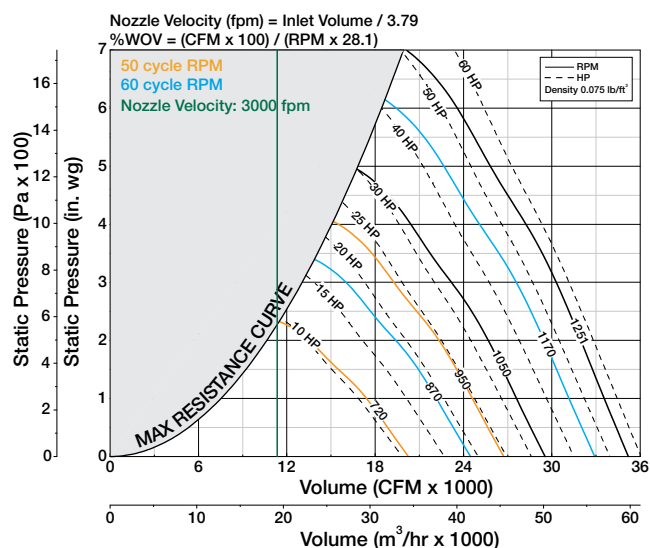
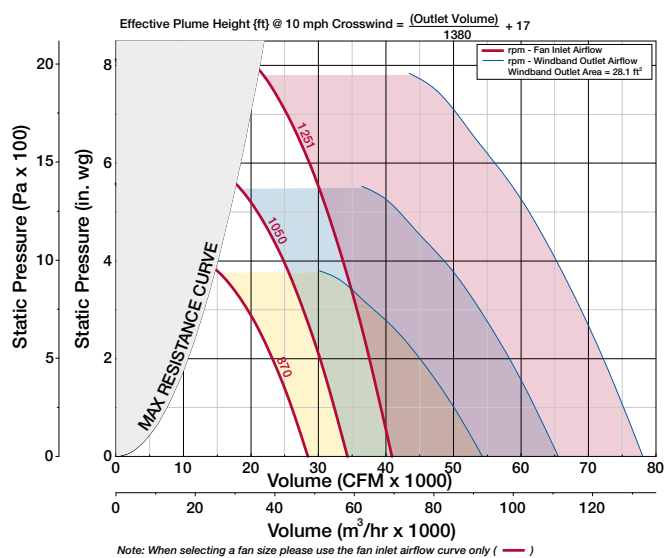
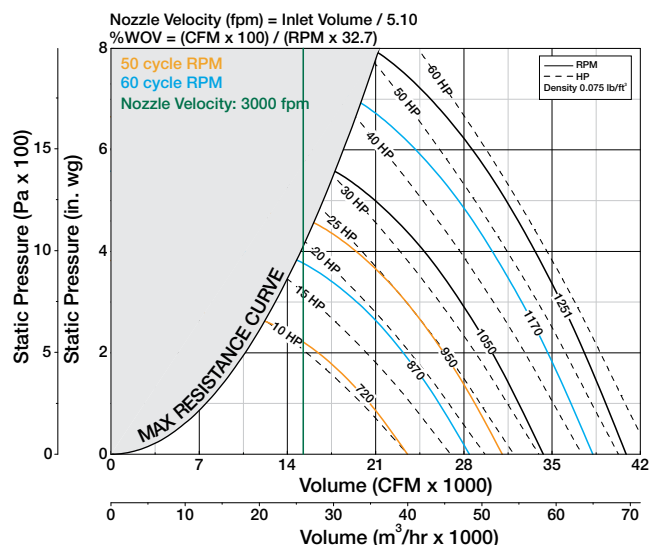
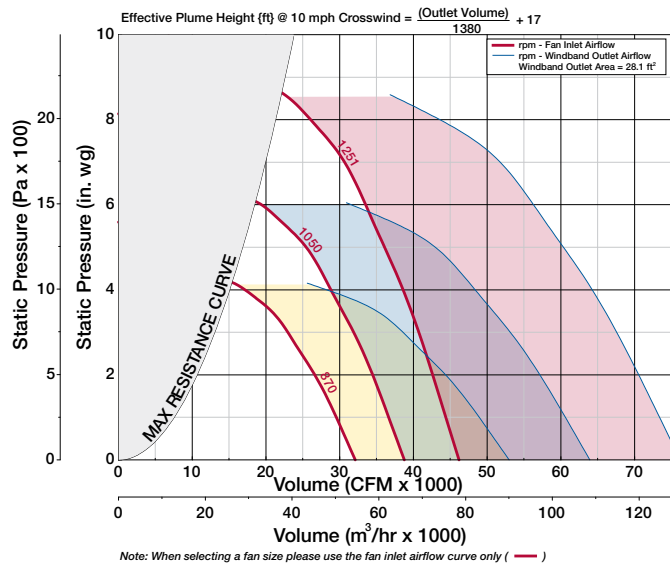
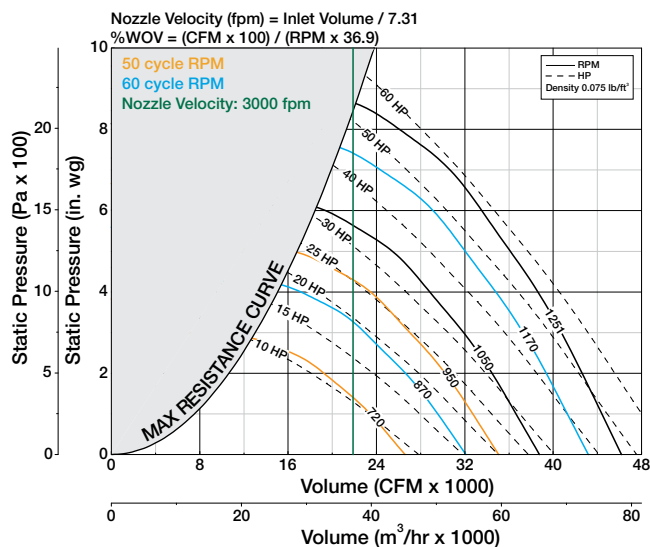

Performance certified is for installation Type A: Free inlet, Free outlet. Power rating (Bhp) does not include transmission losses. Performance ratings do not include the effects of cross winds. Performance ratings do not include the effects of appurtenances (accessories).

Inlet Airflow

70% Wheel Width

Outlet Airflow

LV
Low Velocity

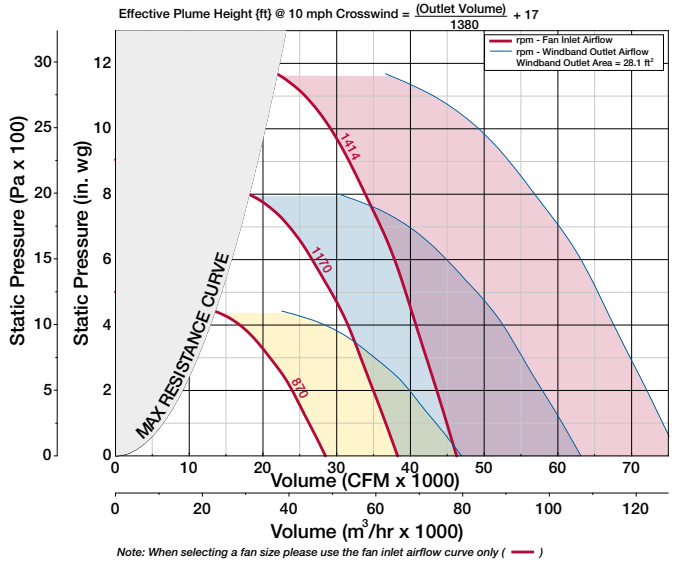
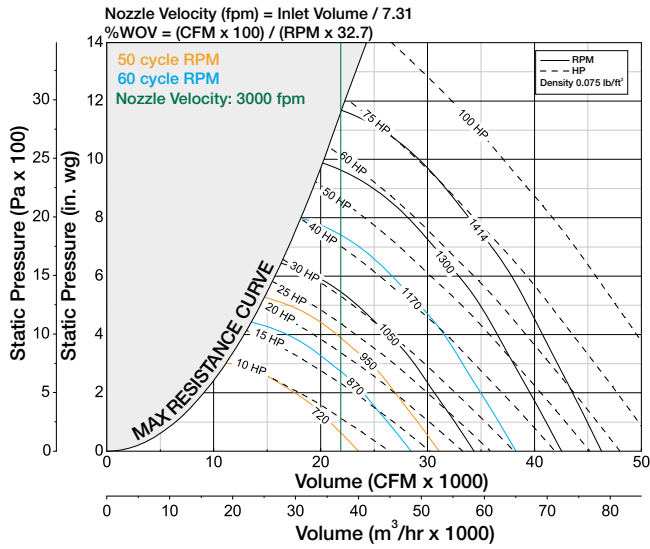

MV
Medium Velocity

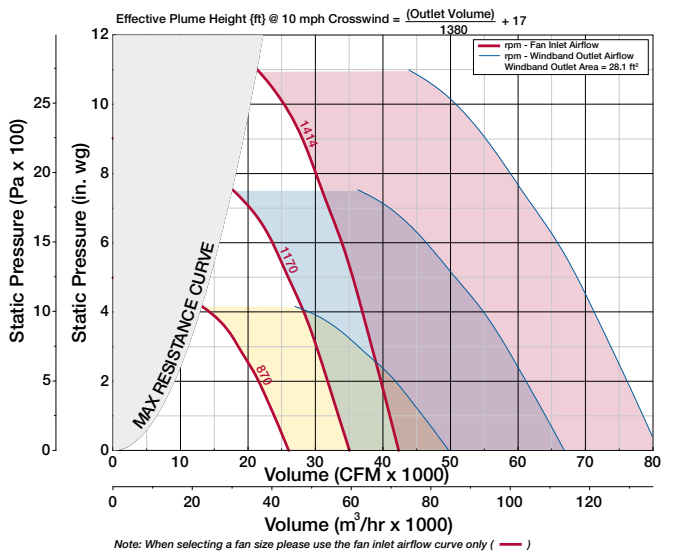
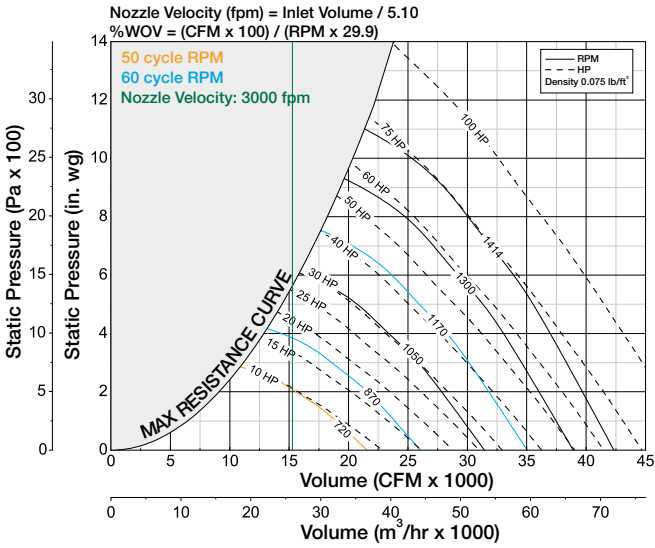

HV
High Velocity

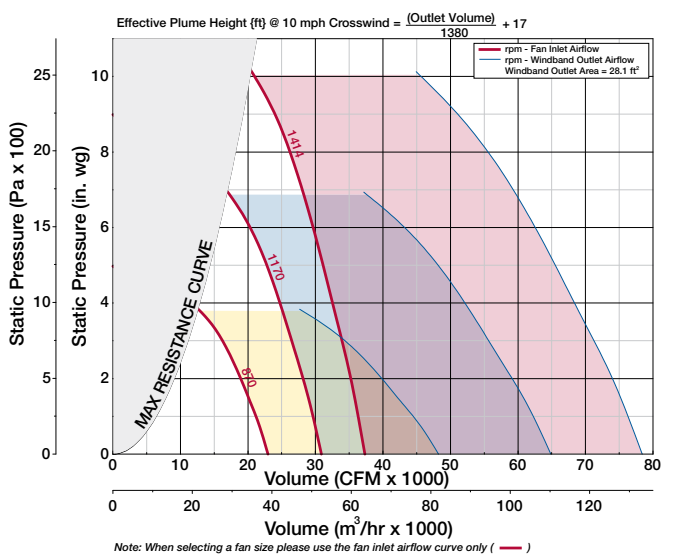
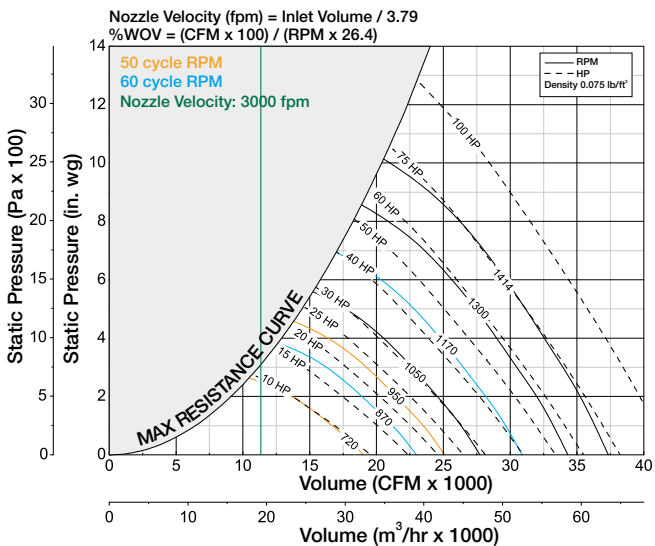

Performance certified is for installation Type A: Free inlet, Free outlet. Power rating (Bhp) does not include transmission losses. Performance ratings do not include the effects of cross winds. Performance ratings do not include the effects of appurtenances (accessories).

Inlet Airflow

50% Wheel Width

Outlet Airflow

AIR DATA

Low Velocity LV

Medium Velocity MV

High Velocity HV

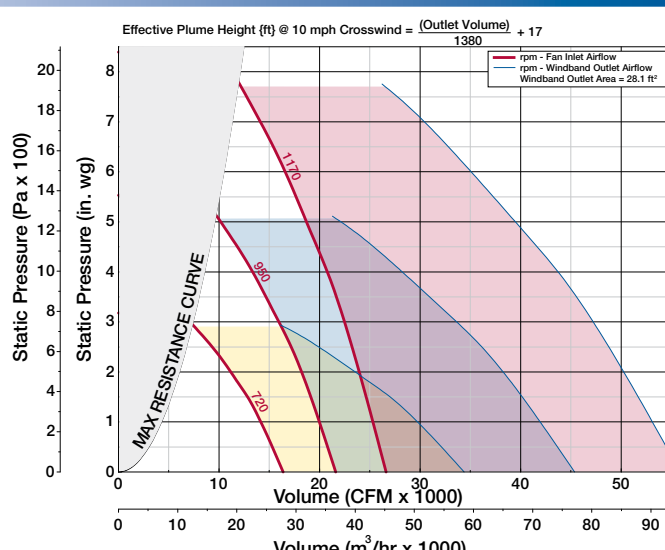
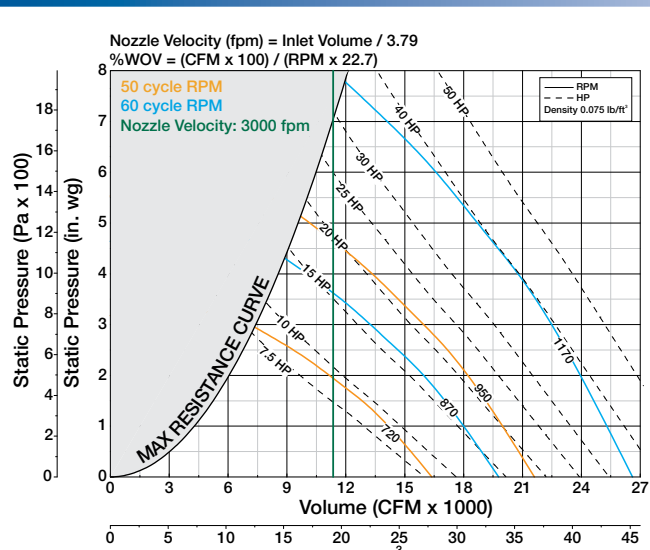
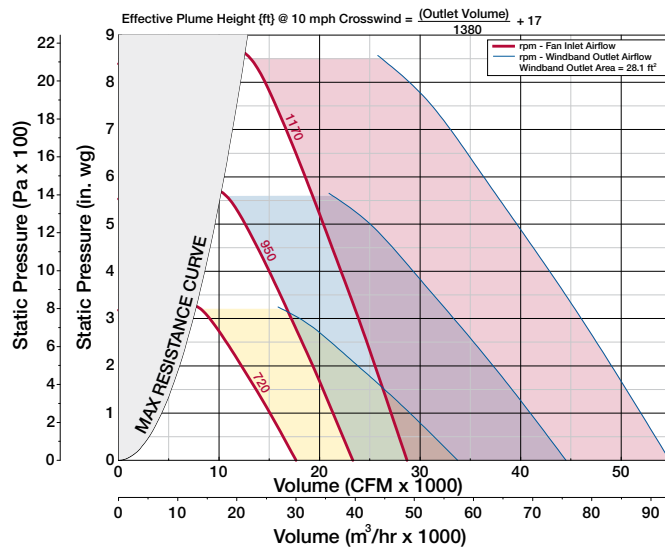
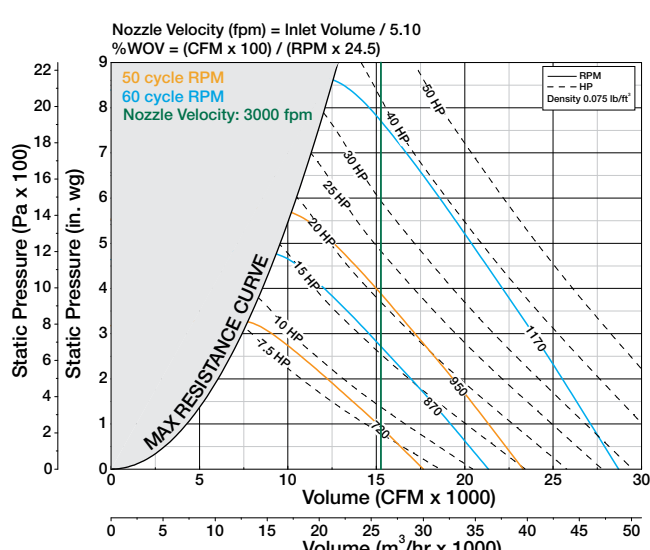
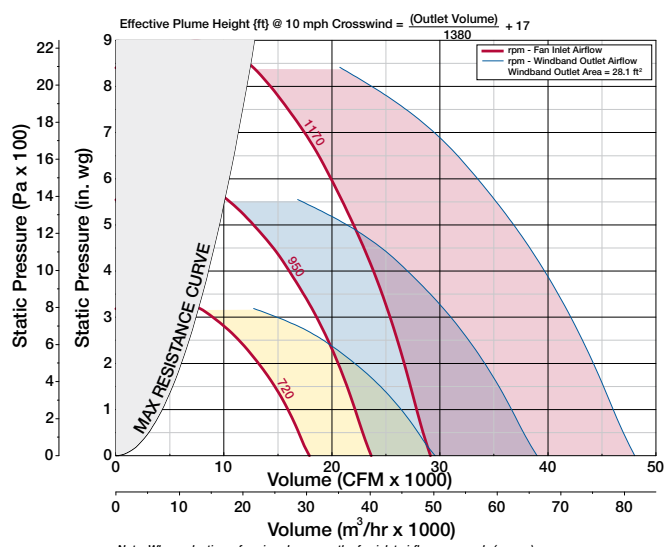
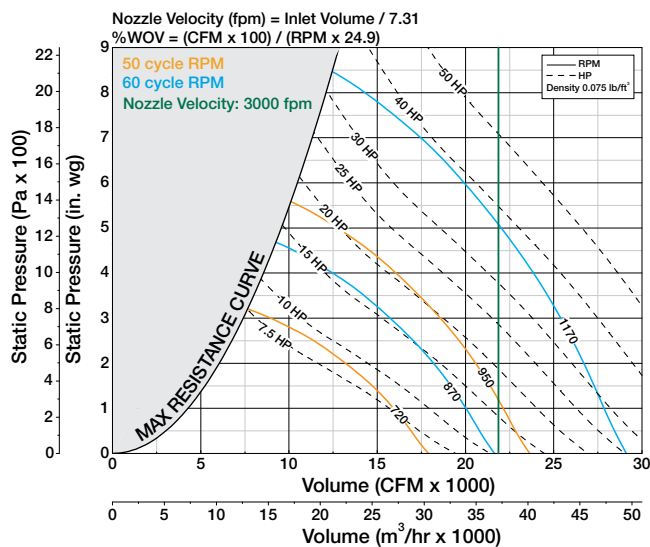

Performance certified is for installation Type A: Free inlet, Free outlet. Power rating (Bhp) does not include transmission losses. Performance ratings do not include the effects of cross winds. Performance ratings do not include the effects of appurtenances (accessories).

AIR DATA

Inlet Airflow

100% Wheel Width

Outlet Airflow

LV
Low Velocity

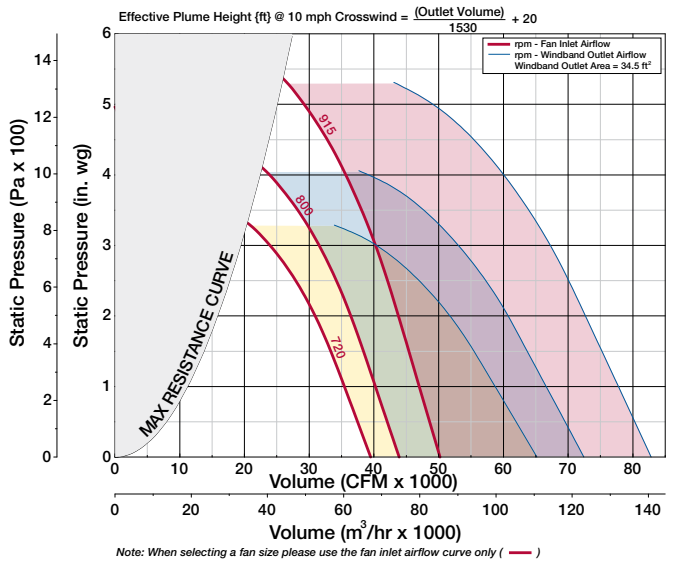
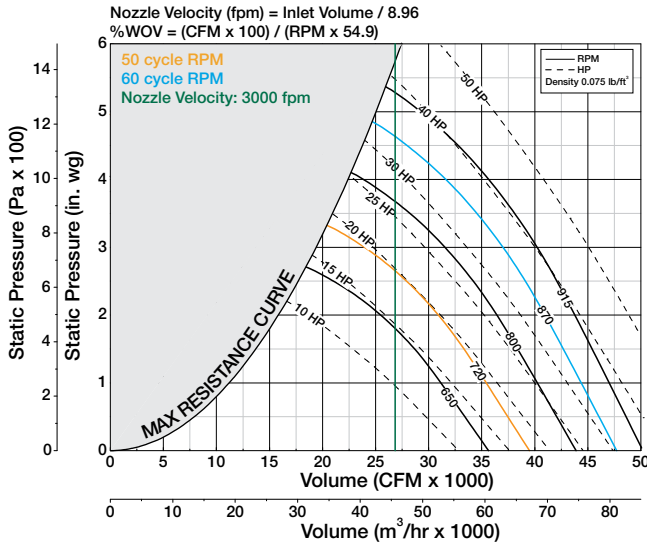

MV
Medium Velocity

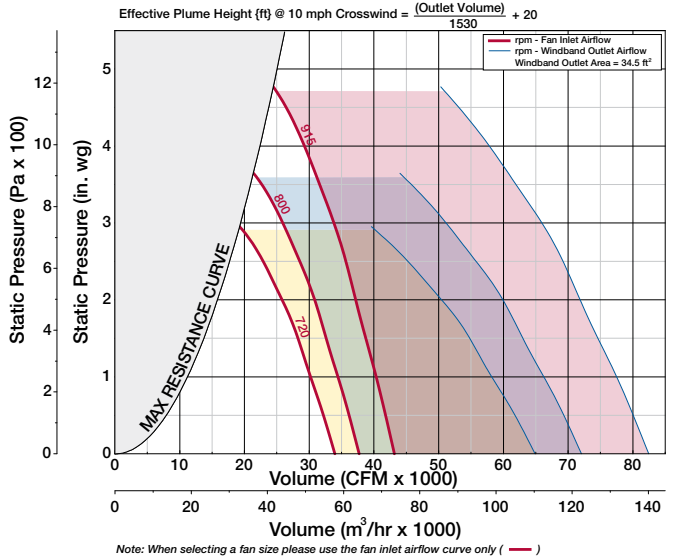
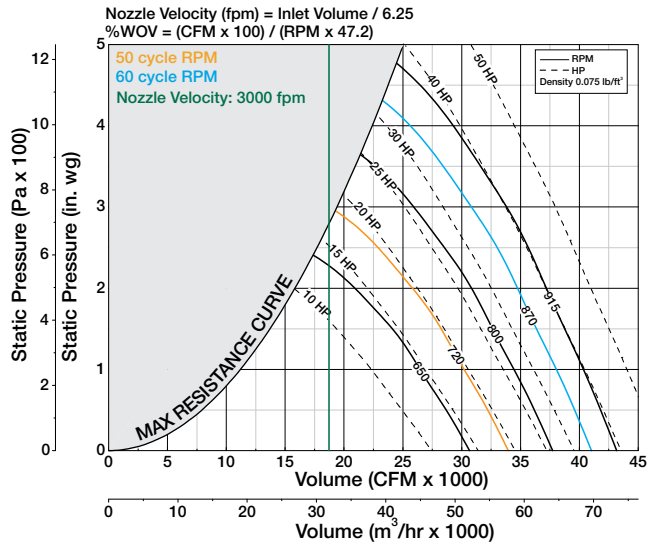

HV
High Velocity

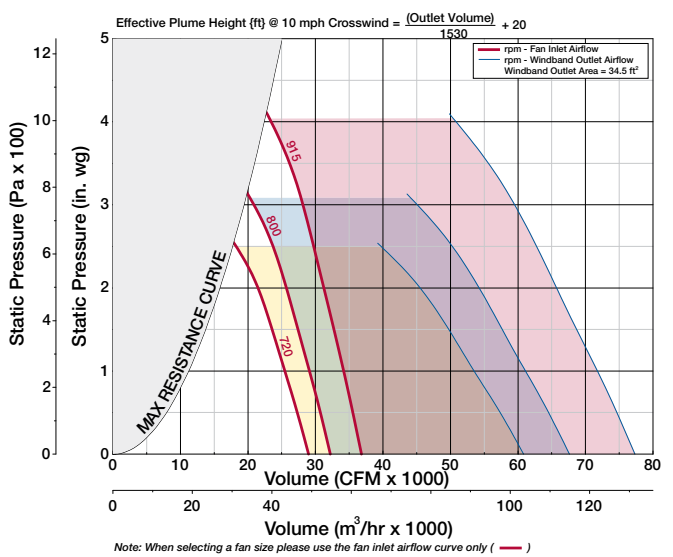
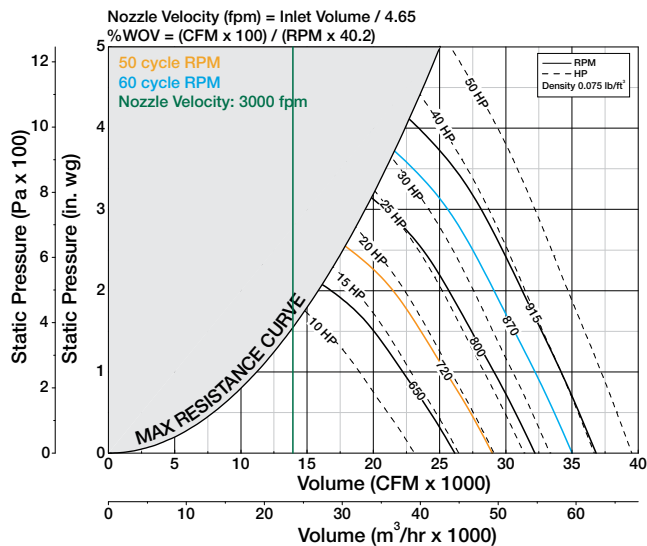

Performance certified is for installation Type A: Free inlet, Free outlet. Power rating (Bhp) does not include transmission losses. Performance ratings do not include the effects of cross winds. Performance ratings do not include the effects of appurtenances (accessories).

Inlet Airflow

85% Wheel Width

Outlet Airflow

AIR DATA

LV
Low Velocity

MV
Medium Velocity

HV
High Velocity

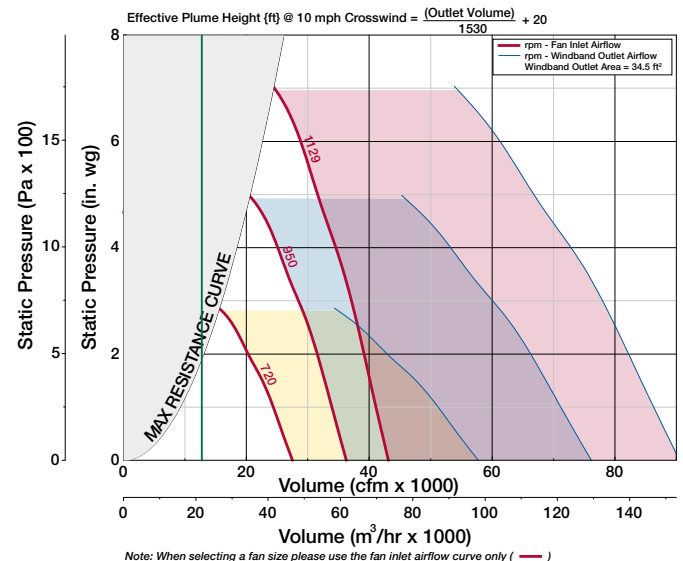
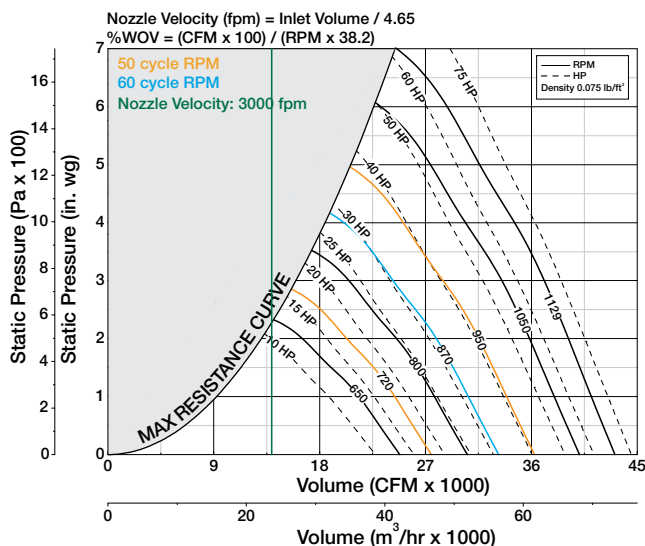
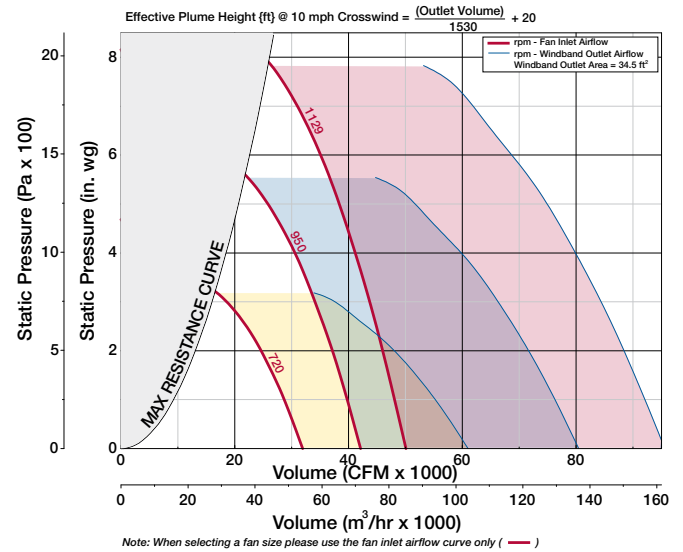
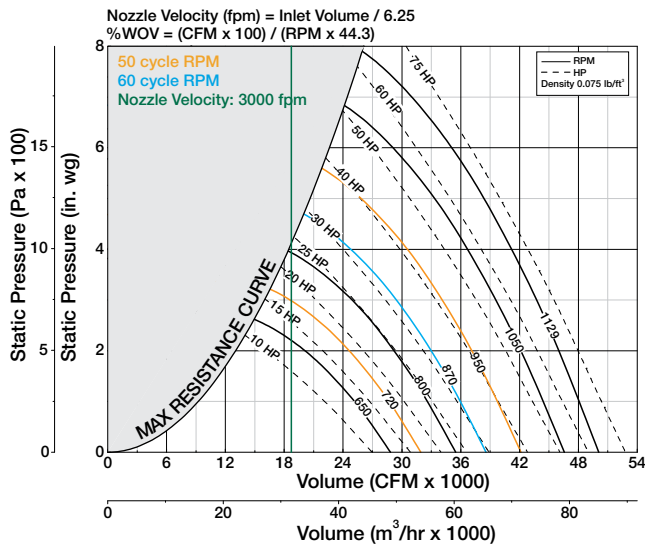
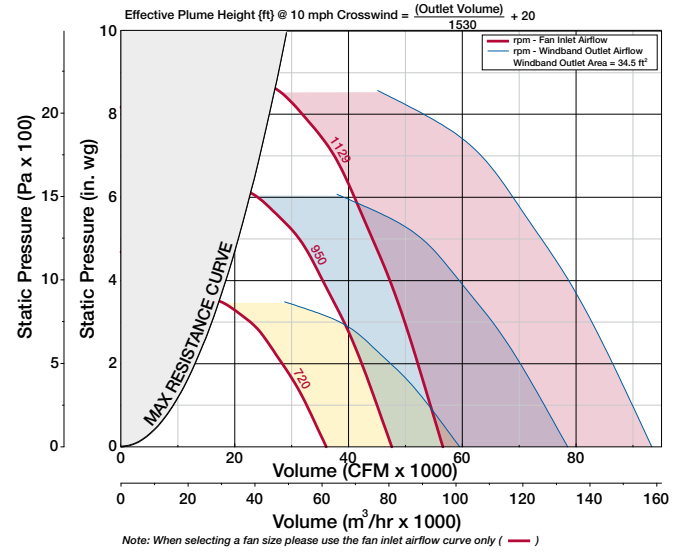
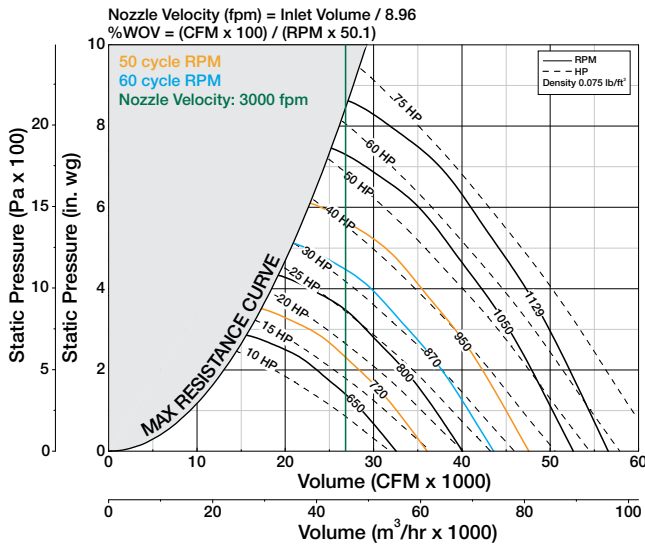

Performance certified is for installation Type A: Free inlet, Free outlet. Power rating (Bhp) does not include transmission losses. Performance ratings do not include the effects of cross winds. Performance ratings do not include the effects of appurtenances (accessories).

Inlet Airflow

70% Wheel Width

Outlet Airflow

Nozzle Velocity (fpm) = Inlet Volume / 8.96
 %WOV = (CFM x 100) / (RPM x 44.4)

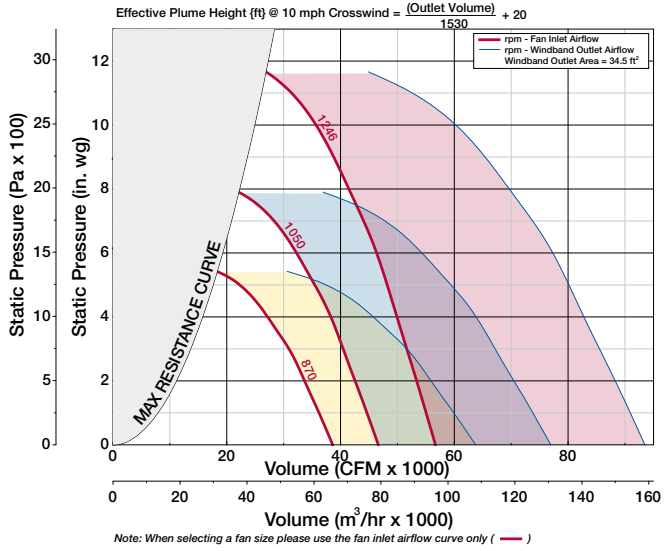
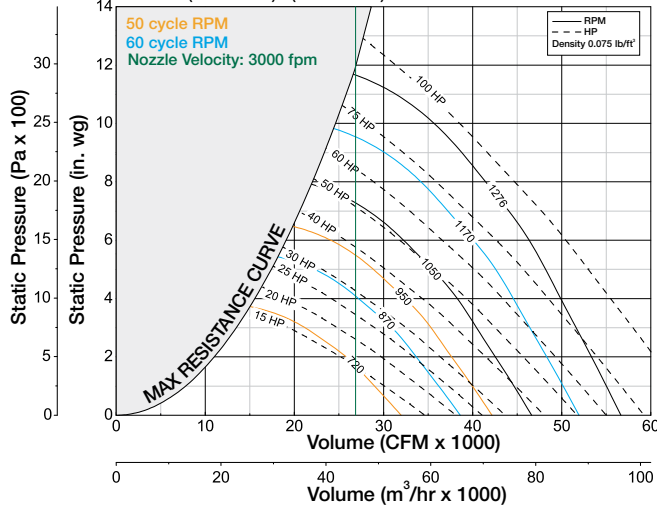

Nozzle Velocity (fpm) = Inlet Volume / 6.25
 %WOV = (CFM x 100) / (RPM x 40.6)

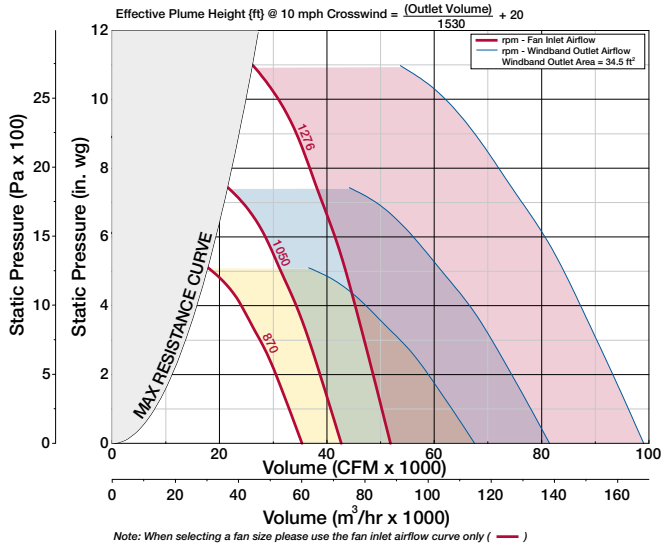
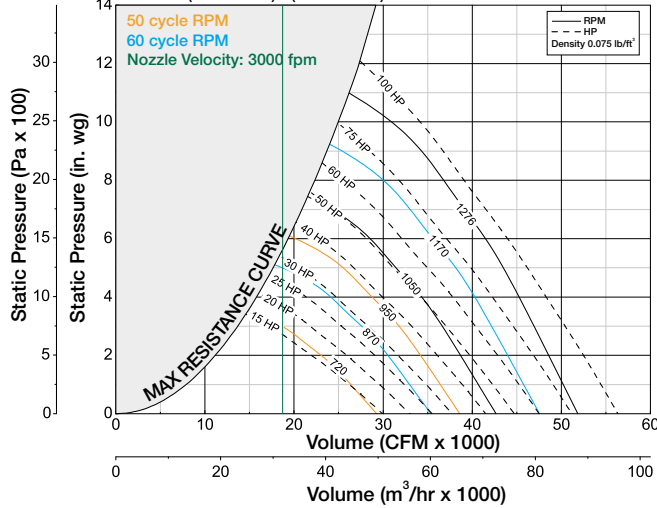

Nozzle Velocity (fpm) = Inlet Volume / 4.65
 %WOV = (CFM x 100) / (RPM x 35.8)

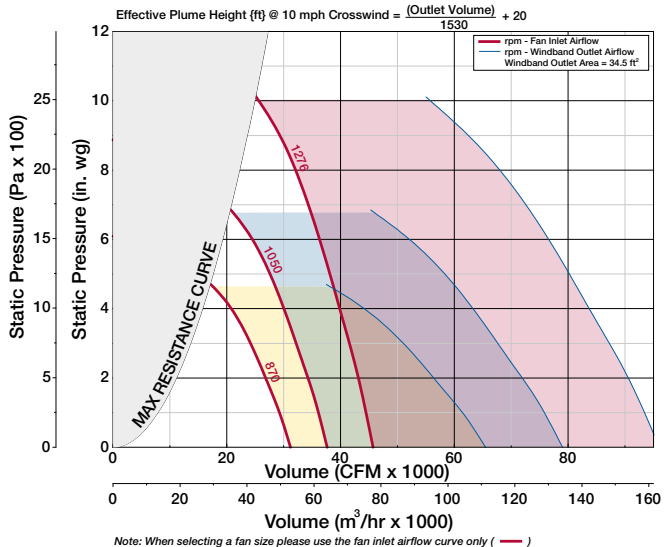
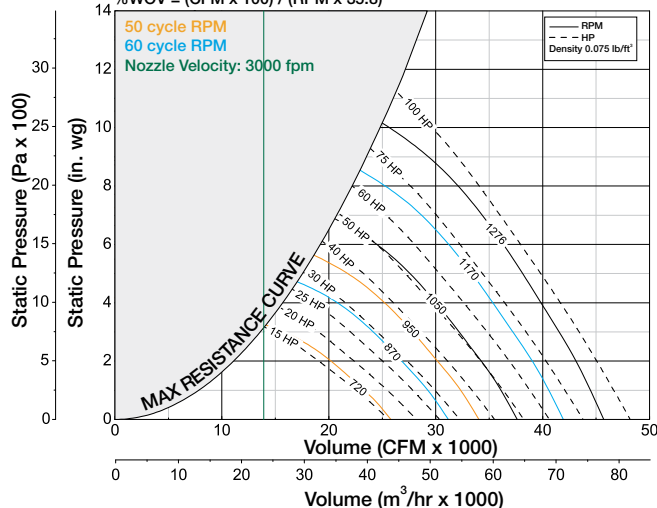

Performance certified is for installation Type A: Free inlet, Free outlet. Power rating (Bhp) does not include transmission losses. Performance ratings do not include the effects of cross winds. Performance ratings do not include the effects of appurtenances (accessories).

Inlet Airflow

50% Wheel Width

Outlet Airflow

AIR DATA

LV
Low Velocity

MV
Medium Velocity

HV
High Velocity

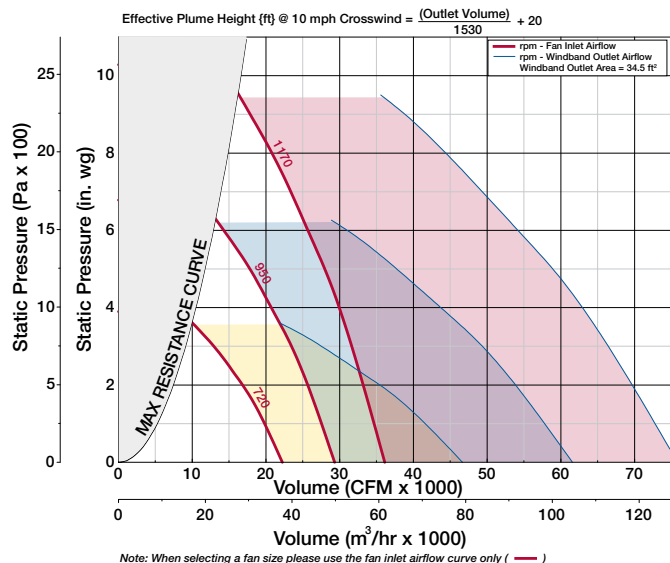
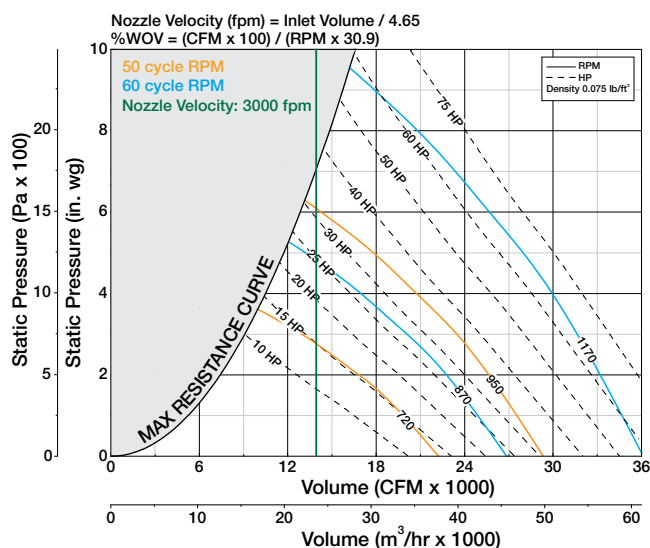
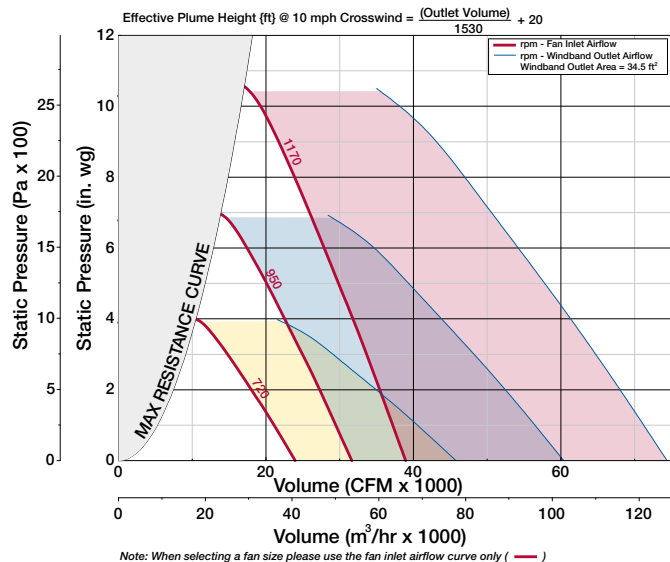
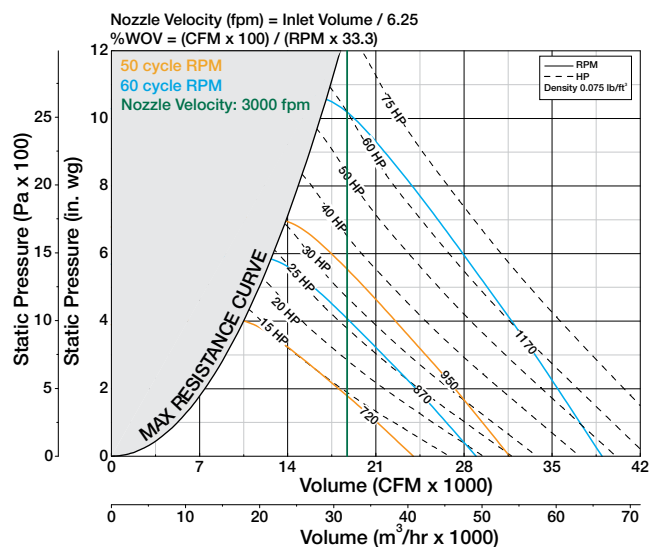
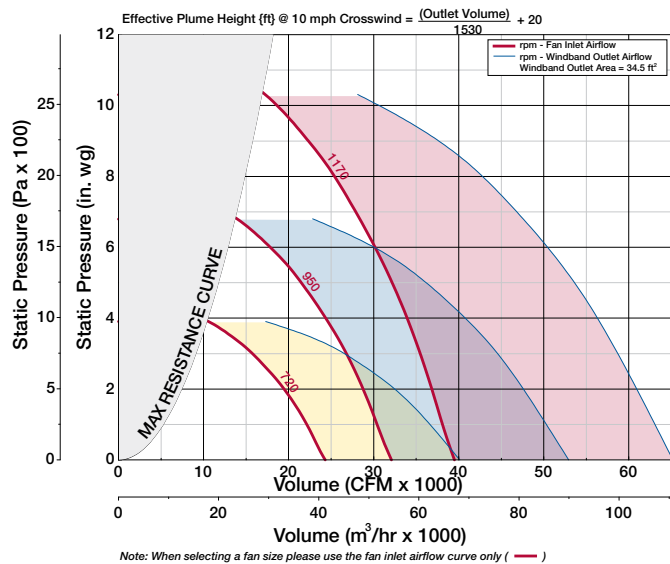
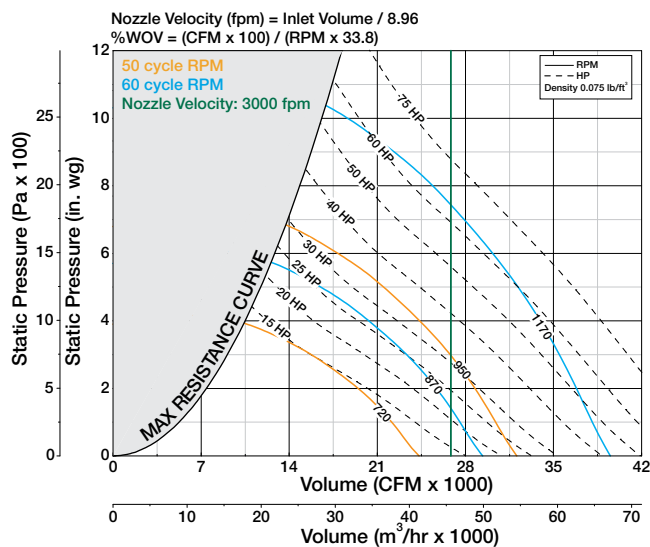

Performance certified is for installation Type A: Free inlet, Free outlet. Power rating (Bhp) does not include transmission losses. Performance ratings do not include the effects of cross winds. Performance ratings do not include the effects of appurtenances (accessories).

AIR DATA

Inlet Airflow

100% Wheel Width

Outlet Airflow

LV
Low Velocity

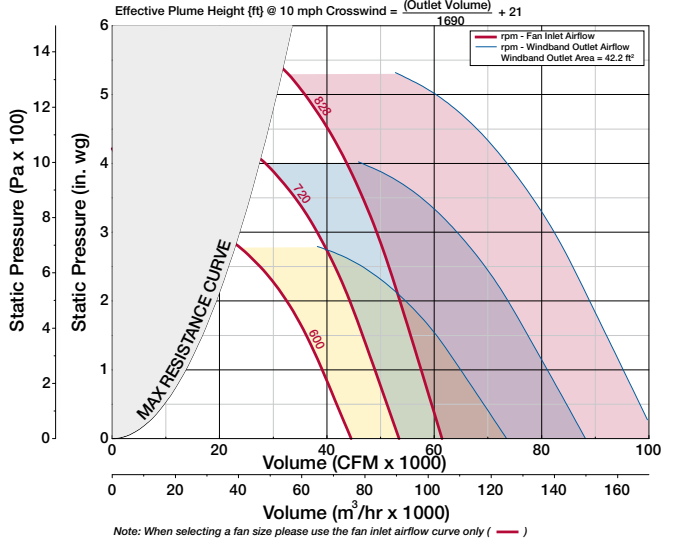
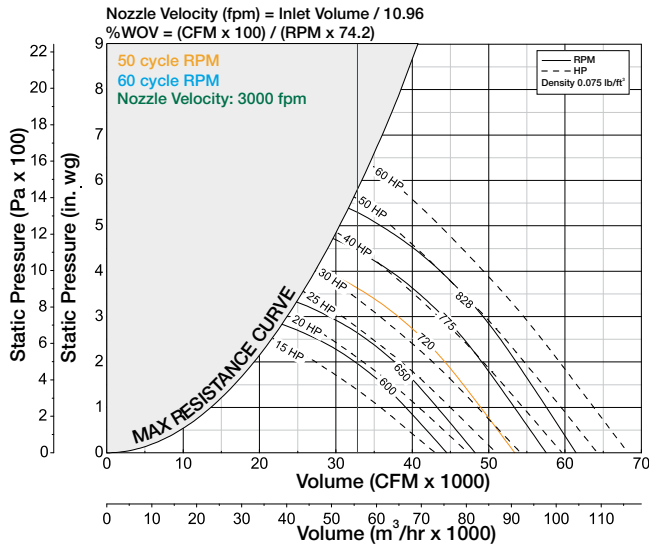

MV
Medium Velocity

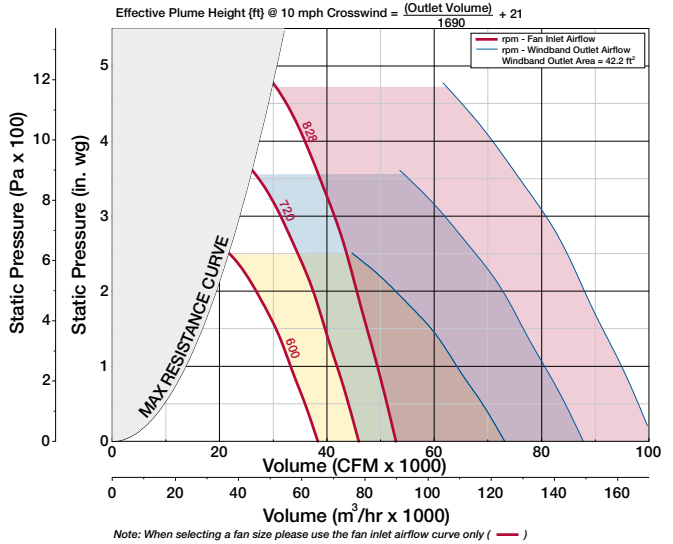
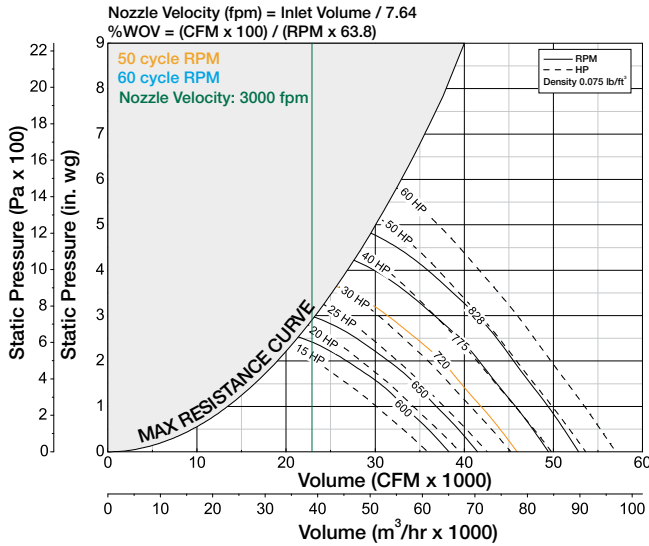

HV
High Velocity

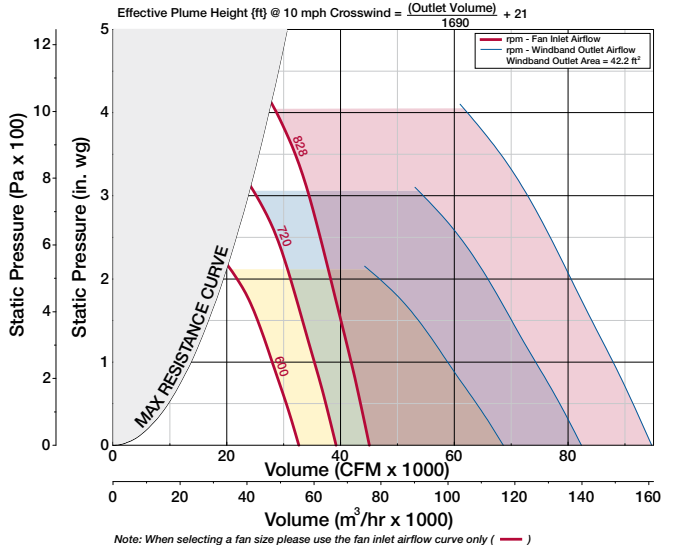
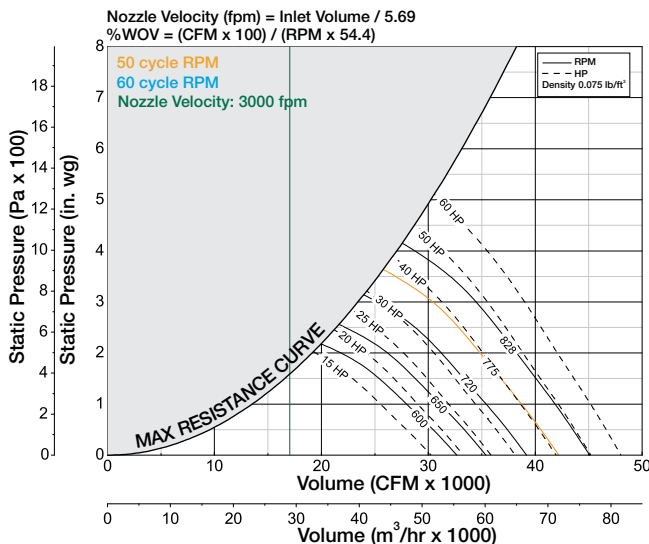

Performance certified is for installation Type A: Free inlet, Free outlet. Power rating (Bhp) does not include transmission losses. Performance ratings do not include the effects of cross winds. Performance ratings do not include the effects of appurtenances (accessories).

Inlet Airflow

85% Wheel Width

Outlet Airflow

AIR DATA

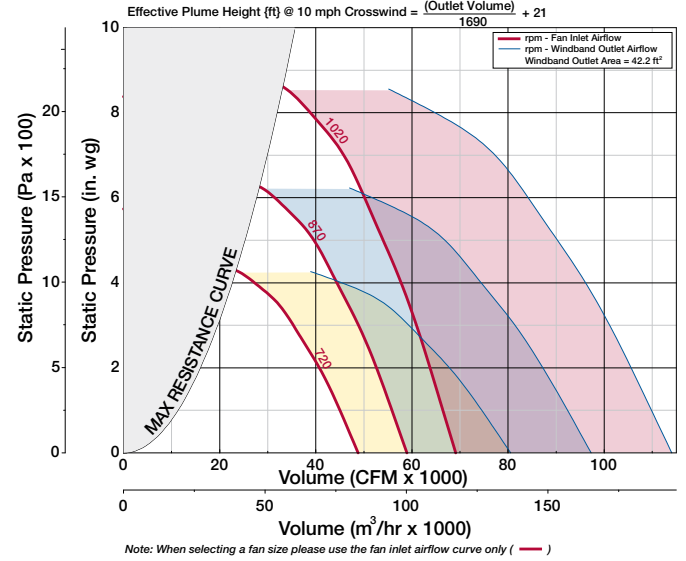
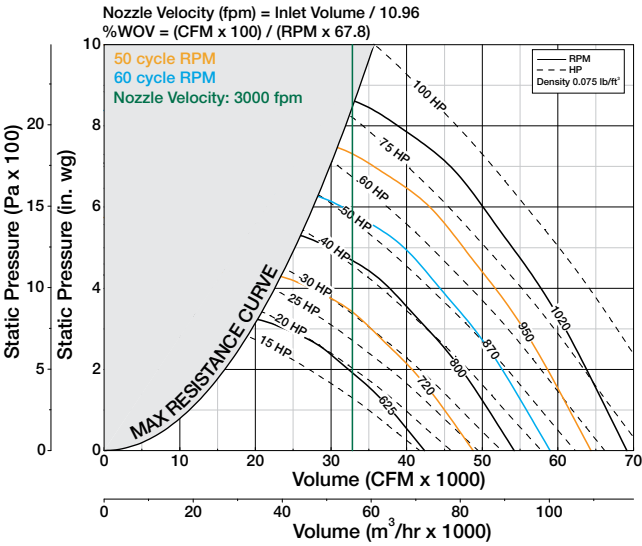

LV
Low Velocity

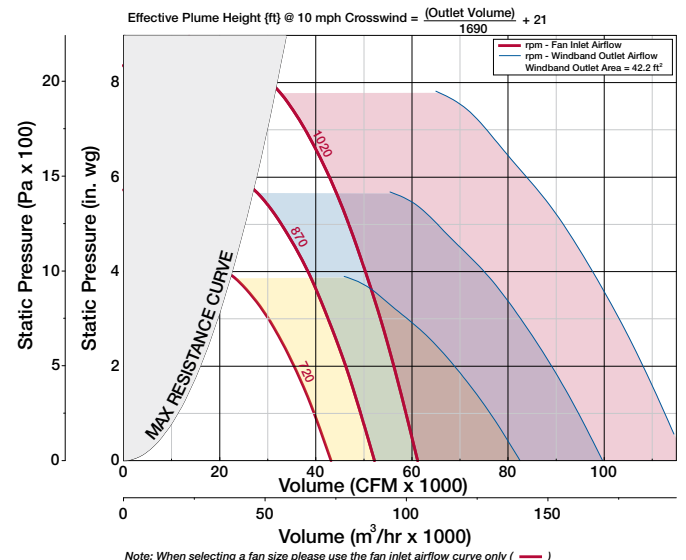
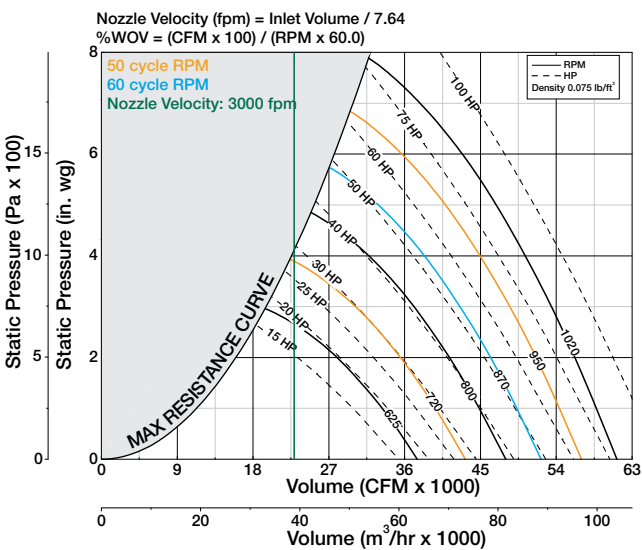

MV
Medium Velocity

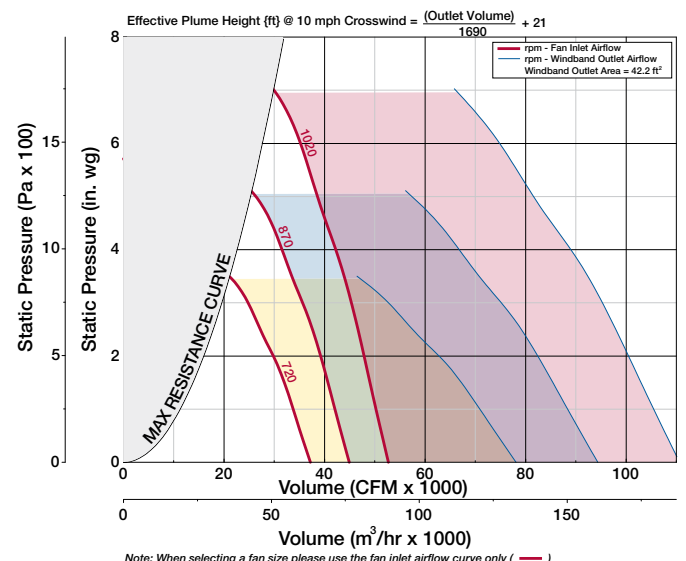
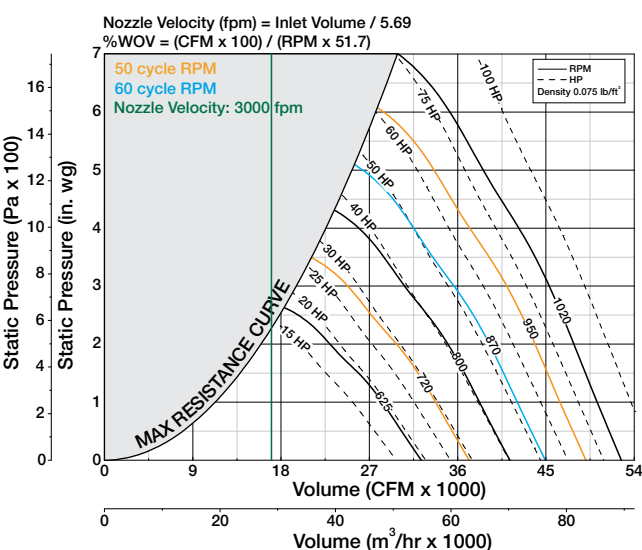

HV
High Velocity

Performance certified is for installation Type A: Free inlet, Free outlet. Power rating (Bhp) does not include transmission losses. Performance ratings do not include the effects of cross winds. Performance ratings do not include the effects of appurtenances (accessories).

AIR DATA

Inlet Airflow

70% Wheel Width

Outlet Airflow

LV
Low Velocity

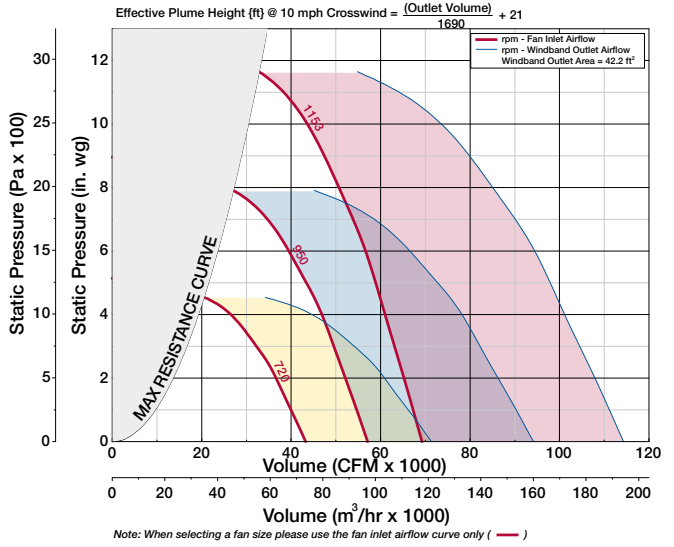
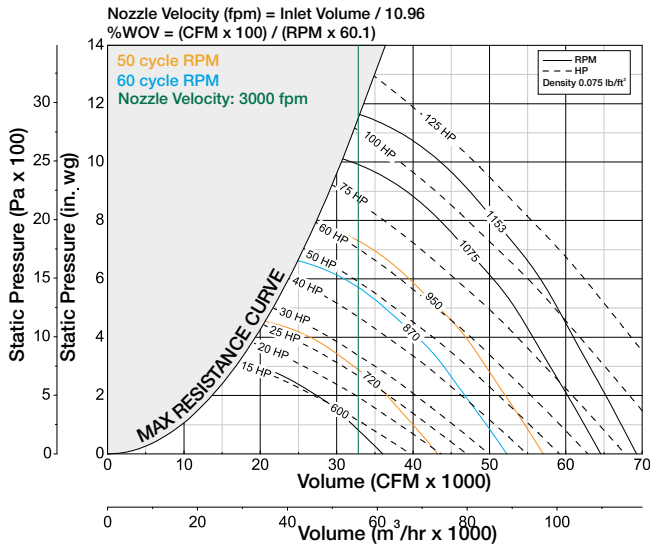

MV
Medium Velocity

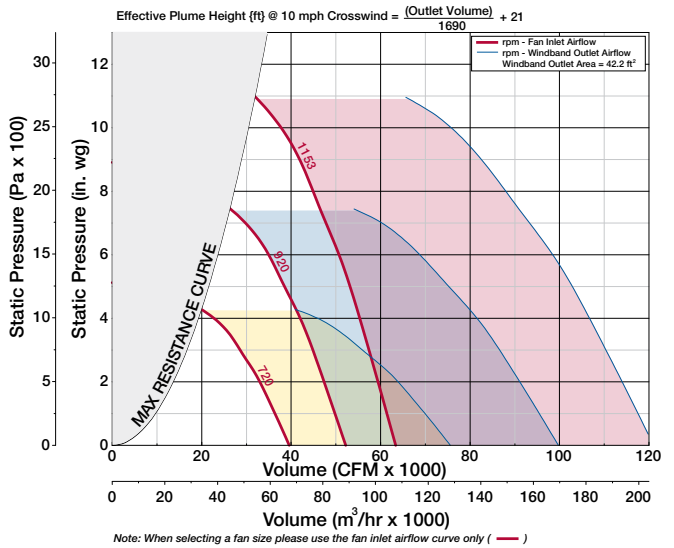
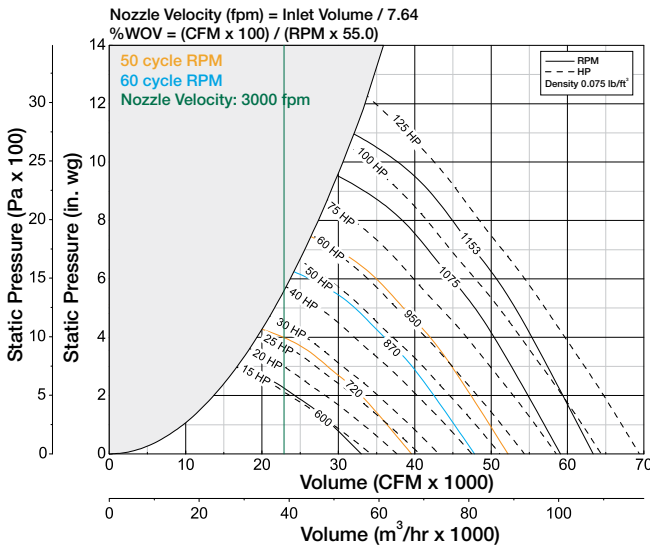

HV
High Velocity

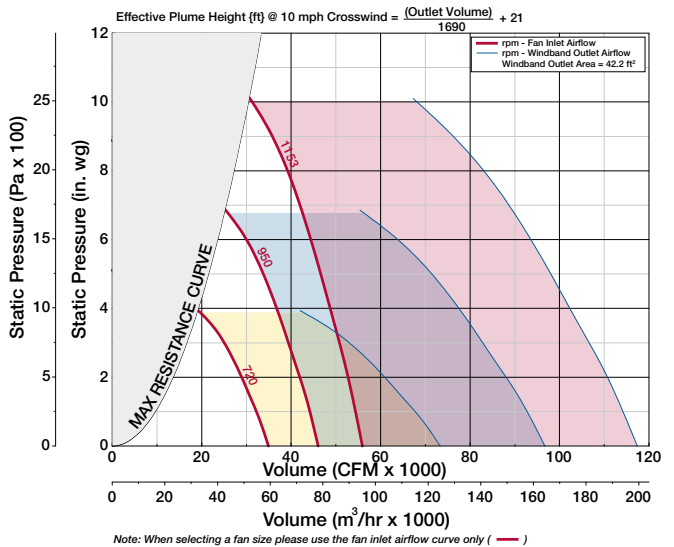
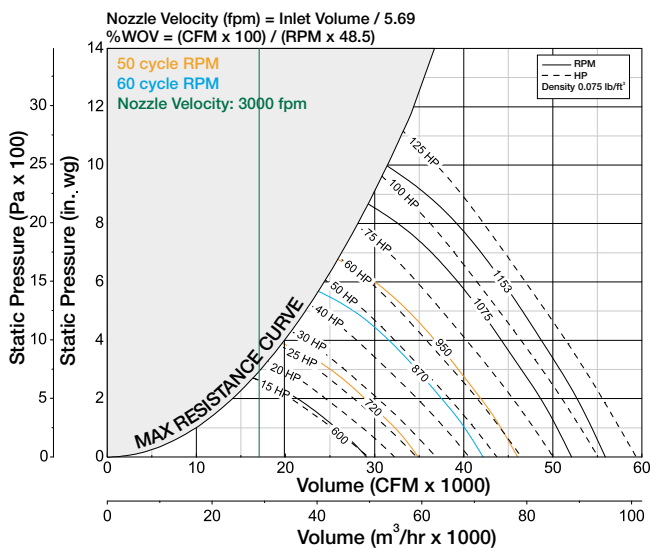

Performance certified is for installation Type A: Free inlet, Free outlet. Power rating (Bhp) does not include transmission losses. Performance ratings do not include the effects of cross winds. Performance ratings do not include the effects of appurtenances (accessories).

Inlet Airflow

50% Wheel Width

Outlet Airflow

AIR DATA

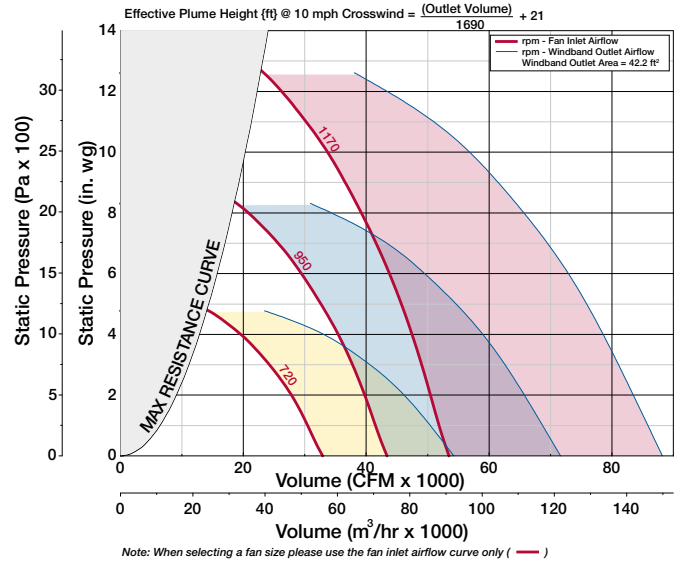
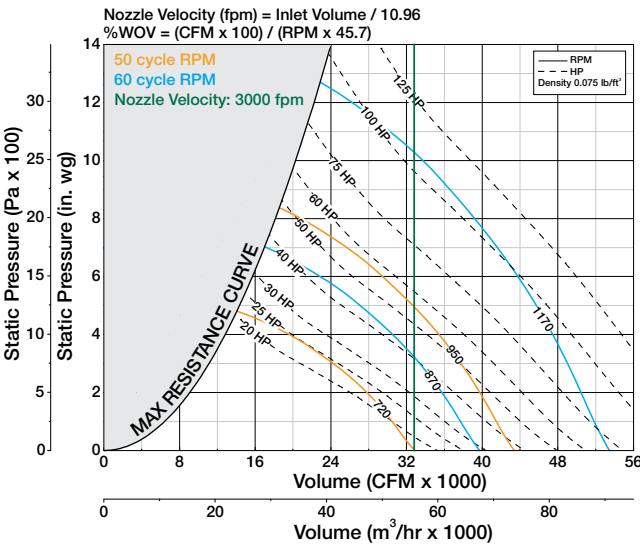

LV
Low Velocity

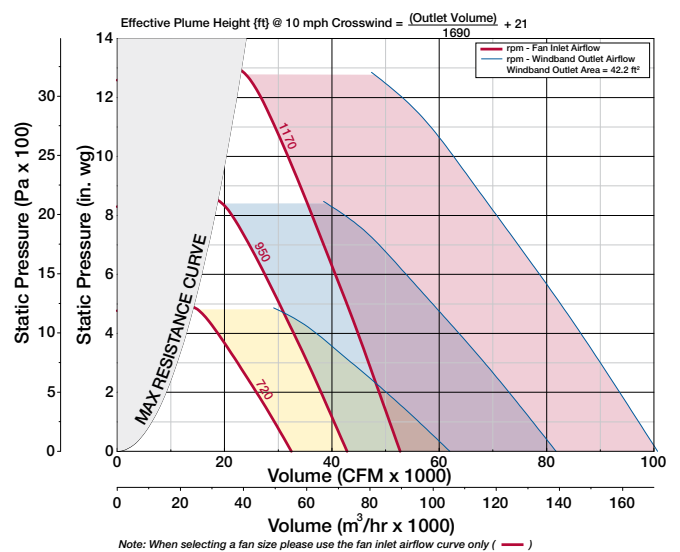
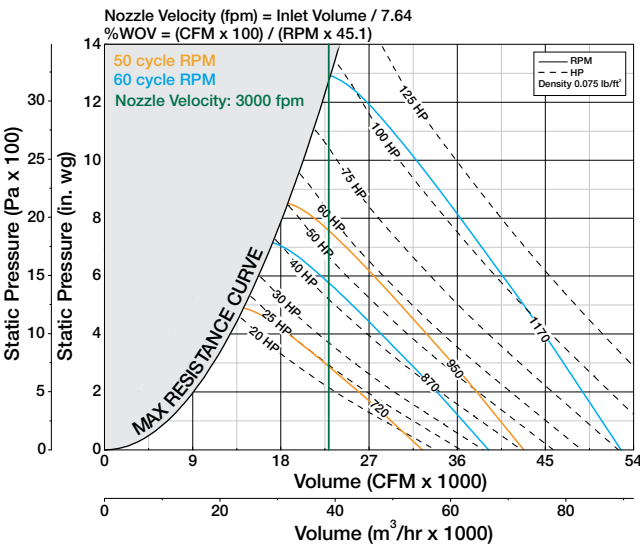

MV
Medium Velocity

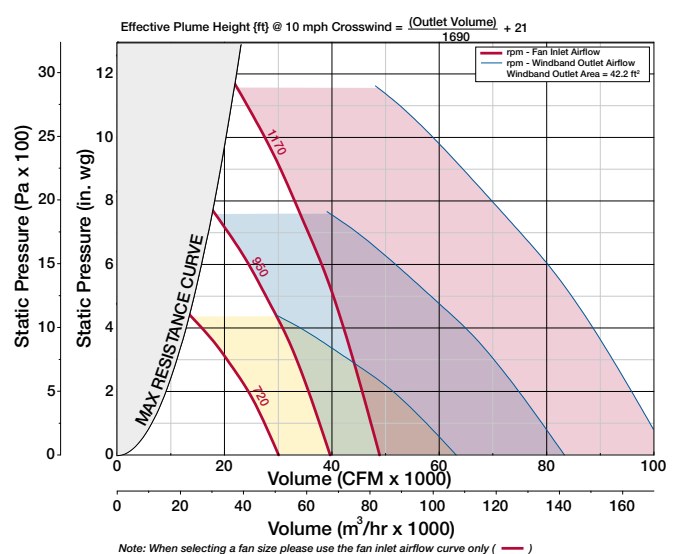
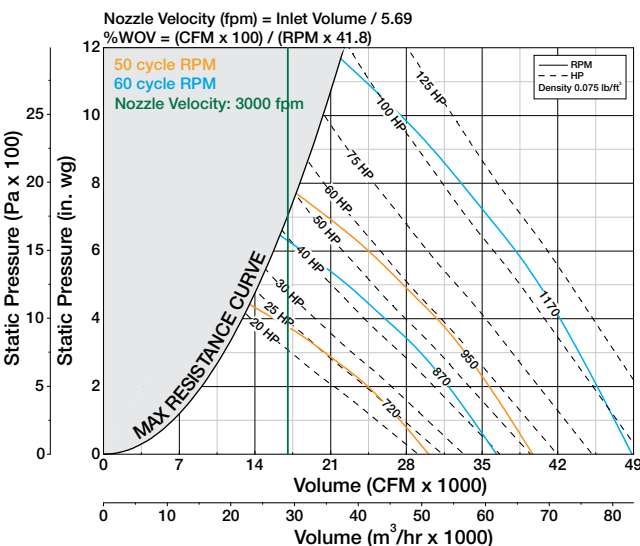

HV
High Velocity

Performance certified is for installation Type A: Free inlet, Free outlet. Power rating (Bhp) does not include transmission losses. Performance ratings do not include the effects of cross winds. Performance ratings do not include the effects of appurtenances (accessories).

How to Calculate Sound Performance

Once a Vektor-MD low velocity fan has been selected that meets performance specifications, use the following procedure to attain sound data for the specific fan rpm and percent wide open volume (%WOV). Interpolation will be used to determine the eight sound power levels, the total sound power (L_{wA}) and sound pressure (dBA) rating.

The Vektor-MD Size 30, Low Velocity Nozzle is operating at 1000 rpm and 68% WO. Viewing the size 30 sound power table, interpolation between 60 and 80% WO is needed to find values for 68% WO.

Example of Sound Performance:

Vektor-MD Size 30 100% Wheel Width (LV Nozzle)

Sound Power by Octave Band																					
Inlet Sound Power												Outlet Sound Power									
rpm	%WOV	1	2	3	4	5	6	7	8	L_{wA}	dBA	1	2	3	4	5	6	7	8	L_{wA}	dBA
500	100	83	78	70	72	74	69	56	46	77	65	80	79	77	82	80	69	62	56	83	72
500	80	81	77	69	72	73	70	57	46	76	65	78	80	76	82	80	71	64	56	83	72
500	60	78	77	67	71	73	70	57	46	76	65	79	79	76	82	80	72	64	56	83	72
500	50	86	77	68	71	73	70	57	45	76	65	79	79	76	83	80	72	64	56	84	72
700	100	84	87	79	78	79	75	65	54	82	71	81	83	83	83	84	77	69	58	86	75
700	80	83	84	78	76	77	75	67	53	81	70	81	83	82	81	84	77	71	59	86	75
700	60	81	82	76	75	76	75	68	54	81	69	81	84	81	80	83	78	71	59	86	74
700	50	90	85	77	76	76	75	68	54	81	70	83	85	82	81	83	78	71	59	86	74
1000	100	91	95	87	87	84	83	74	66	90	78	85	91	92	91	89	84	77	67	93	82
1000	80	88	93	84	84	83	78	74	64	87	76	83	88	90	89	88	82	77	66	92	80
1000	60	87	89	82	82	82	78	74	64	86	74	83	86	88	87	87	82	77	66	90	79
1000	50	94	92	85	84	82	78	74	64	87	75	88	90	90	89	88	82	78	66	92	80
1400	100	96	94	100	96	93	90	86	77	99	87	91	93	99	100	96	92	88	78	101	90
1400	80	93	90	96	93	91	86	80	73	95	84	89	90	96	98	94	90	85	76	99	88
1400	60	92	90	92	91	89	85	80	73	93	82	90	91	95	96	92	88	84	76	97	86

Example

Interpolate the low velocity sound data at 1000 rpm between 80% and 60% WO to find 68% WO for each octave band.

1st Octave Inlet Sound

$$1000 \text{ rpm @ } 68\% \text{ WO, dB} = \left[88 \text{ dB} - \left\{ \left(\frac{80\% - 68\%}{80\% - 60\%} \right) \times (88 \text{ dB} - 87 \text{ dB}) \right\} \right] = 87 \text{ dB}$$

2nd Octave Inlet Sound

$$1000 \text{ rpm @ } 68\% \text{ WO, dB} = \left[93 \text{ dB} - \left\{ \left(\frac{80\% - 68\%}{80\% - 60\%} \right) \times (93 \text{ dB} - 89 \text{ dB}) \right\} \right] = 91 \text{ dB}$$

The same procedure should be followed to calculate the remaining inlet and outlet sound values. If the fan selection results in a fan RPM not shown, sound power levels are calculated at the next RPM above and below the operating RPM, then interpolated to the operating RPM.

Results for above example are as follows:

Sound Power by Octave Band																					
Inlet Sound Power												Outlet Sound Power									
rpm	%WOV	1	2	3	4	5	6	7	8	L_{wA}	dBA	1	2	3	4	5	6	7	8	L_{wA}	dBA
1000	68	87	91	83	83	82	78	74	64	86	75	83	87	89	88	87	82	77	66	91	79

SOUND DATA

Vektor-MD Size 15 100% Wheel Width

Sound Power by Octave Band																					
Inlet Sound Power												Outlet Sound Power									
rpm	%WOV	1	2	3	4	5	6	7	8	L _w A	dBA	1	2	3	4	5	6	7	8	L _w A	dBA
1000	100	73	75	74	67	67	58	51	41	71	60	79	79	75	72	73	65	62	52	76	65
1000	80	73	72	74	65	67	58	51	41	71	59	80	79	75	71	72	64	62	52	75	64
1000	60	73	72	74	65	66	57	50	40	70	59	82	78	75	71	71	64	61	51	75	63
1000	50	74	75	74	65	66	57	50	40	70	59	82	80	75	71	71	63	58	49	75	63
1400	100	75	81	73	69	70	65	59	50	74	63	76	83	77	74	73	68	64	52	78	66
1400	80	76	79	72	68	69	64	58	49	73	61	75	80	76	73	72	67	62	52	76	65
1400	60	80	80	72	67	68	63	57	50	72	61	74	80	76	73	71	67	63	53	76	65
1400	50	79	81	72	68	68	63	57	50	73	61	77	82	76	73	71	66	62	53	76	65
1900	100	74	76	79	76	77	73	66	59	80	69	83	78	80	79	79	74	68	61	82	71
1900	80	76	76	76	74	76	71	66	59	79	68	82	81	80	77	77	71	66	58	81	69
1900	60	78	79	77	74	74	70	64	59	78	67	79	80	81	77	76	70	65	59	80	69
1900	50	81	84	78	75	75	70	64	60	79	68	80	82	81	78	77	71	66	60	81	70
2700	100	83	81	84	83	85	82	78	70	89	77	84	86	87	87	88	85	79	71	92	80
2700	80	79	83	84	81	83	80	76	69	87	75	82	88	86	86	86	82	76	69	90	78
2700	60	81	85	83	83	83	80	75	69	87	76	83	88	88	86	85	80	75	69	89	78
2700	50	84	90	86	84	83	80	75	69	88	76	84	88	89	87	85	80	75	69	89	78
3732	100	93	90	88	92	91	92	87	80	97	85	92	94	94	96	95	94	89	82	100	88
3732	80	87	91	88	91	89	90	86	80	95	84	92	96	93	95	93	92	86	80	98	87
3732	60	87	93	91	90	89	90	85	78	95	84	93	96	94	96	93	90	84	79	98	86
3732	50	88	97	96	92	90	89	85	78	96	84	93	97	96	97	93	90	85	79	98	87

Values shown are for inlet L_{wi}A and outlet L_{wO}A sound power levels for installation Type A: Free inlet, Free outlet. The sound power level ratings shown are in decibels, referred to 10⁻¹² watts calculated per AMCA Standard 301. The A-weighted sound ratings shown have been calculated per AMCA International Standard 301. dBA levels are not licensed by AMCA International. The AMCA Certified Ratings Seal applies to L_{wi}A and L_{wO}A values only.

Vektor-MD Size 16 100% Wheel Width

Sound Power by Octave Band																					
Inlet Sound Power												Outlet Sound Power									
rpm	%WOV	1	2	3	4	5	6	7	8	L _w A	dBA	1	2	3	4	5	6	7	8	L _w A	dBA
900	100	71	77	73	67	66	58	50	40	71	59	77	79	75	72	71	64	61	51	75	64
900	80	71	74	72	66	65	58	50	40	70	58	77	79	75	71	70	64	62	51	75	63
900	60	72	74	72	65	64	57	49	39	69	57	79	78	76	70	69	64	61	50	74	63
900	50	73	76	72	65	64	57	49	39	69	58	79	80	75	70	69	63	58	48	74	62
1300	100	76	83	73	70	71	66	59	50	75	64	77	85	78	75	74	69	64	53	78	67
1300	80	77	81	73	69	70	65	58	50	74	63	76	82	77	74	73	68	63	52	77	66
1300	60	81	82	72	68	69	64	58	50	73	62	76	82	77	73	72	67	63	53	77	65
1300	50	81	82	72	69	69	63	58	51	74	62	79	84	77	74	72	67	63	53	77	66
1800	100	76	78	80	78	78	74	67	60	82	70	84	80	82	81	80	75	69	62	84	72
1800	80	79	78	77	76	77	73	67	60	80	69	85	82	82	79	78	72	67	59	82	70
1800	60	80	81	79	76	76	72	65	61	80	68	81	81	82	79	78	72	67	60	82	70
1800	50	84	85	80	77	76	72	65	61	81	69	83	83	83	80	78	72	68	61	82	71
2500	100	83	82	86	84	86	83	78	70	90	78	85	87	89	88	89	85	79	71	92	81
2500	80	81	83	86	82	84	81	77	70	88	76	84	88	88	87	87	82	77	70	91	79
2500	60	83	86	84	83	84	80	75	70	88	76	85	88	89	87	86	81	75	69	90	78
2500	50	87	90	87	85	84	81	75	70	89	77	86	89	91	88	86	81	75	70	90	79
3440	100	95	91	89	93	93	92	88	81	98	86	95	95	95	97	96	94	89	82	101	89
3440	80	88	93	90	92	91	90	86	80	96	85	93	99	94	97	95	92	86	80	99	88
3440	60	89	95	92	91	90	91	85	79	96	85	94	99	95	97	94	90	85	79	99	87
3440	50	91	99	96	93	91	90	85	79	97	85	95	99	97	98	94	91	85	80	99	88

Values shown are for inlet L_{wi}A and outlet L_{wO}A sound power levels for installation Type A: Free inlet, Free outlet. The sound power level ratings shown are in decibels, referred to 10⁻¹² watts calculated per AMCA Standard 301. The A-weighted sound ratings shown have been calculated per AMCA International Standard 301. dBA levels are not licensed by AMCA International. The AMCA Certified Ratings Seal applies to L_{wi}A and L_{wO}A values only.

SOUND DATA

Vektor-MD Size 18 100% Wheel Width



Sound Power by Octave Band																					
		Inlet Sound Power										Outlet Sound Power									
rpm	%WOV	1	2	3	4	5	6	7	8	L _W A	dBA	1	2	3	4	5	6	7	8	L _W A	dBA
800	100	70	80	68	65	65	63	56	47	71	59	66	72	69	73	71	64	58	51	74	63
800	80	68	78	66	64	64	61	56	48	69	58	66	72	68	74	71	64	58	51	75	63
800	60	70	76	65	64	64	61	56	49	69	57	66	71	69	73	71	64	59	52	75	63
800	40	73	75	65	64	63	61	56	48	68	57	68	73	71	73	71	64	59	51	75	63
1200	100	78	82	87	74	74	70	64	56	81	69	73	81	82	79	80	72	65	58	83	71
1200	80	79	80	84	71	72	69	65	58	79	67	73	81	81	77	78	71	65	58	81	70
1200	60	80	79	80	71	71	68	64	58	77	65	73	81	80	76	77	71	65	59	80	69
1200	40	81	80	80	71	71	68	64	57	77	65	75	81	80	76	77	71	65	59	80	69
1600	100	81	79	89	80	80	77	70	63	85	74	77	82	89	84	83	79	75	64	88	76
1600	80	81	78	86	78	78	75	69	63	83	72	76	82	86	83	82	78	75	63	86	75
1600	60	83	78	84	77	76	74	69	63	82	70	77	83	85	82	80	78	75	64	85	74
1600	40	83	81	83	78	76	74	69	63	82	70	78	84	86	82	81	78	75	64	86	74
2200	100	86	84	95	88	89	85	80	72	93	82	82	87	93	92	91	87	81	74	95	83
2200	80	86	83	92	86	87	84	78	71	91	80	81	86	90	90	89	84	79	72	93	81
2200	60	89	85	90	86	85	82	77	72	90	78	82	87	91	89	88	83	78	71	92	80
2200	40	90	87	91	87	85	82	77	72	90	79	83	88	91	90	88	83	78	71	92	81
3138	100	87	97	92	104	96	95	91	84	103	92	85	96	96	103	100	97	92	85	105	93
3138	80	89	96	92	101	94	94	89	82	101	90	85	95	96	101	98	96	89	83	103	91
3138	60	92	98	93	99	92	91	88	82	99	88	86	96	98	101	97	94	88	82	102	91
3138	40	93	99	95	100	92	91	88	82	100	88	86	96	99	101	97	94	88	82	102	91

Values shown are for inlet L_WiA and outlet L_WoA sound power levels for installation Type A: Free inlet, Free outlet. The sound power level ratings shown are in decibels, referred to 10⁻¹² watts calculated per AMCA Standard 301. The A-weighted sound ratings shown have been calculated per AMCA International Standard 301. dBA levels are not licensed by AMCA International. The AMCA Certified Ratings Seal applies to L_WiA and L_WoA values only.

Vektor-MD Size 20 100% Wheel Width

Sound Power by Octave Band																					
		Inlet Sound Power										Outlet Sound Power									
rpm	%WOV	1	2	3	4	5	6	7	8	L _W A	dBA	1	2	3	4	5	6	7	8	L _W A	dBA
800	100	74	84	71	68	68	66	59	49	74	62	70	76	73	76	74	67	61	54	77	66
800	80	72	82	69	67	67	64	59	51	72	61	70	76	72	77	74	67	61	54	78	66
800	60	73	79	69	67	67	64	59	52	72	60	70	75	73	76	74	67	62	54	78	66
800	40	76	79	68	67	66	64	59	51	71	60	72	76	74	76	74	67	61	54	78	66
1100	100	80	87	80	74	75	71	64	56	80	68	75	83	79	81	80	72	65	58	83	72
1100	80	81	84	77	72	73	70	65	58	78	66	75	83	79	79	78	71	65	58	81	70
1100	60	81	82	76	72	72	69	64	58	77	65	75	83	77	78	78	71	65	59	81	70
1100	40	83	82	76	72	72	69	64	58	77	65	77	83	77	78	77	71	65	59	81	69
1500	100	83	81	91	82	82	78	71	64	87	76	80	84	91	86	84	80	76	65	89	78
1500	80	82	80	88	80	80	76	70	64	85	73	79	84	89	85	83	79	76	64	88	76
1500	60	84	80	86	78	78	75	70	65	83	72	80	85	87	84	82	79	76	65	87	76
1500	40	85	82	85	79	78	75	70	65	83	72	81	86	88	84	82	79	76	65	87	76
2100	100	89	86	97	90	91	87	81	73	95	83	85	89	96	94	93	88	82	75	97	85
2100	80	88	85	94	88	89	85	80	73	93	82	84	88	93	92	91	86	80	73	95	83
2100	60	91	87	92	87	87	83	79	73	91	80	84	90	94	91	90	84	79	73	94	82
2100	40	92	89	94	88	86	83	79	74	92	80	86	91	93	92	89	84	79	73	94	82
2844	100	92	97	93	104	98	95	91	83	104	92	88	98	97	103	101	97	92	85	105	94
2844	80	93	97	93	101	96	93	89	82	102	90	87	97	96	101	99	95	89	83	103	92
2844	60	96	99	94	99	94	91	88	82	100	88	87	97	98	101	98	94	88	82	102	91
2844	40	97	99	96	100	94	91	88	82	100	89	88	98	100	101	98	93	88	82	102	91

Values shown are for inlet L_WiA and outlet L_WoA sound power levels for installation Type A: Free inlet, Free outlet. The sound power level ratings shown are in decibels, referred to 10⁻¹² watts calculated per AMCA Standard 301. The A-weighted sound ratings shown have been calculated per AMCA International Standard 301. dBA levels are not licensed by AMCA International. The AMCA Certified Ratings Seal applies to L_WiA and L_WoA values only.

SOUND DATA

Vektor-MD Size 22 100% Wheel Width



Sound Power by Octave Band																					
rpm	%WOV	Inlet Sound Power										Outlet Sound Power									
		1	2	3	4	5	6	7	8	L _w A	dBA	1	2	3	4	5	6	7	8	L _w A	dBA
700	100	77	80	73	69	72	69	61	48	76	64	75	78	77	78	81	72	63	57	83	71
700	80	74	78	72	68	71	70	62	49	75	64	74	77	77	78	81	73	65	58	83	71
700	60	75	76	72	67	71	70	62	48	75	64	74	77	77	78	81	73	66	58	83	71
700	50	82	81	72	68	71	70	62	48	76	64	76	78	77	78	81	74	66	58	83	72
1000	100	81	87	80	76	77	76	69	57	82	71	82	84	81	82	82	79	72	62	86	74
1000	80	81	85	78	74	75	75	70	57	81	69	81	84	79	80	81	79	73	63	85	74
1000	60	79	82	76	73	75	74	71	58	80	68	81	85	79	80	81	79	73	63	85	74
1000	50	87	87	78	74	75	74	71	58	81	69	82	86	80	80	81	79	74	63	85	74
1300	100	88	83	90	85	83	80	74	64	88	77	79	82	87	89	87	82	77	67	91	79
1300	80	84	80	88	81	81	77	72	63	86	74	78	80	84	88	86	80	76	67	90	78
1300	60	84	80	84	79	79	76	72	63	84	72	77	81	83	85	85	80	76	67	88	77
1300	50	90	88	85	82	80	76	72	63	85	74	82	85	86	86	85	80	76	67	89	77
1800	100	92	88	97	91	92	87	85	75	96	84	85	88	95	97	94	90	87	77	99	87
1800	80	89	85	92	87	89	84	79	71	92	81	84	85	92	94	92	87	83	75	96	85
1800	60	89	85	89	85	87	83	78	71	91	79	84	87	91	92	90	86	82	75	94	83
1800	50	94	91	93	88	87	84	78	72	92	80	87	91	94	94	91	87	83	75	96	84
2559	100	96	100	100	104	100	97	93	88	105	94	91	97	100	104	104	100	96	91	108	96
2559	80	94	97	96	100	97	94	89	83	102	90	92	94	97	101	102	98	93	88	105	94
2559	60	95	97	96	96	94	92	88	83	99	88	92	96	97	100	100	96	92	87	104	92
2559	50	100	102	101	100	96	94	89	83	102	90	94	99	101	103	101	97	93	87	105	94

Values shown are for inlet L_{wi}A and outlet L_{wO}A sound power levels for installation Type A: Free inlet, Free outlet. The sound power level ratings shown are in decibels, referred to 10⁻¹² watts calculated per AMCA Standard 301. The A-weighted sound ratings shown have been calculated per AMCA International Standard 301. dBA levels are not licensed by AMCA International. The AMCA Certified Ratings Seal applies to L_{wi}A and L_{wO}A values only.

Vektor-MD Size 24 100% Wheel Width

Sound Power by Octave Band																					
rpm	%WOV	Inlet Sound Power										Outlet Sound Power									
		1	2	3	4	5	6	7	8	L _w A	dBA	1	2	3	4	5	6	7	8	L _w A	dBA
600	100	79	80	71	70	72	68	58	46	75	64	75	79	76	79	80	69	62	56	82	70
600	80	76	79	69	69	71	69	59	46	75	63	74	78	75	79	80	71	64	56	82	71
600	60	75	77	68	68	71	69	59	46	75	63	75	78	75	79	80	72	64	56	82	71
600	50	82	81	69	68	71	69	59	46	75	64	76	78	75	79	80	72	65	56	82	71
900	100	84	87	79	77	78	77	68	56	83	71	83	84	82	83	84	79	71	61	87	75
900	80	83	84	78	75	76	75	70	56	81	69	83	83	80	82	83	79	73	62	86	75
900	60	81	82	76	74	76	75	70	56	81	69	83	84	80	80	83	79	74	62	86	75
900	50	89	86	78	75	76	75	70	56	81	70	83	86	81	81	83	79	74	62	86	75
1200	100	88	87	92	85	84	81	75	65	89	78	81	85	90	90	88	83	77	67	92	81
1200	80	85	85	91	82	82	77	73	64	87	76	80	82	87	89	87	81	77	67	91	79
1200	60	85	83	86	80	80	77	73	64	85	73	79	83	85	86	86	81	77	67	89	78
1200	50	91	89	87	83	81	77	73	64	86	75	84	87	88	88	86	81	77	67	90	79
1700	100	94	90	99	93	93	88	86	76	97	86	88	90	97	99	96	91	88	79	100	89
1700	80	91	87	94	90	91	86	80	73	94	83	87	87	94	96	94	89	85	77	98	87
1700	60	91	87	91	88	88	84	79	73	92	80	87	89	93	94	92	88	84	76	96	85
1700	50	96	94	95	91	89	86	80	73	94	83	90	93	96	96	93	89	84	76	98	86
2300	100	101	100	104	103	101	97	94	88	105	94	94	98	102	105	104	100	97	90	108	97
2300	80	98	97	100	98	98	95	89	83	102	91	94	96	99	102	102	98	94	87	106	94
2300	60	98	96	98	95	95	93	88	82	100	88	94	97	99	101	100	96	92	87	104	92
2300	50	103	102	103	98	96	94	89	82	102	90	95	101	103	103	101	97	93	87	105	94

Values shown are for inlet L_{wi}A and outlet L_{wO}A sound power levels for installation Type A: Free inlet, Free outlet. The sound power level ratings shown are in decibels, referred to 10⁻¹² watts calculated per AMCA Standard 301. The A-weighted sound ratings shown have been calculated per AMCA International Standard 301. dBA levels are not licensed by AMCA International. The AMCA Certified Ratings Seal applies to L_{wi}A and L_{wO}A values only.

SOUND DATA

Vektor-MD Size 27 100% Wheel Width



Sound Power by Octave Band																					
Inlet Sound Power												Outlet Sound Power									
rpm	%WOV	1	2	3	4	5	6	7	8	L _w A	dBA	1	2	3	4	5	6	7	8	L _w A	dBA
600	100	82	84	74	72	75	71	61	49	78	67	79	82	79	82	83	72	65	58	85	73
600	80	79	82	72	72	74	72	62	49	78	66	78	82	79	82	83	74	67	59	85	74
600	60	78	80	71	71	74	72	62	49	78	66	78	82	78	82	83	75	67	59	85	74
600	50	85	85	72	71	74	72	62	48	78	67	80	82	78	82	82	75	67	59	85	73
800	100	84	88	79	77	79	76	67	56	83	71	80	85	83	83	84	78	70	60	87	75
800	80	83	85	78	75	77	75	68	55	81	70	80	84	81	81	83	78	72	60	86	74
800	60	81	82	76	74	76	75	69	55	81	69	80	85	81	80	83	79	73	61	86	75
800	50	89	86	77	75	76	75	69	55	81	70	83	87	82	81	83	79	73	61	86	75
1100	100	90	93	87	86	84	82	74	66	89	78	83	89	90	91	88	84	77	67	93	81
1100	80	86	91	84	83	82	78	74	64	86	75	82	86	88	89	87	82	77	66	91	80
1100	60	86	87	81	81	81	77	74	64	85	74	81	84	86	86	87	81	77	66	90	78
1100	50	93	90	84	83	82	78	74	64	86	75	86	88	88	88	87	82	77	67	91	79
1500	100	94	91	100	94	92	88	85	76	98	86	89	91	97	99	95	91	88	78	100	89
1500	80	91	87	95	92	90	85	79	72	94	83	88	87	95	97	93	89	84	75	98	87
1500	60	91	88	92	89	87	84	79	72	92	80	89	89	94	95	91	87	83	75	96	85
1500	50	96	94	95	91	88	85	79	72	94	82	92	93	97	96	92	88	83	75	97	86
2087	100	102	100	106	101	101	97	95	87	106	94	95	99	104	106	105	100	97	89	108	97
2087	80	99	96	102	97	99	95	89	82	103	91	95	96	101	103	103	98	94	87	106	95
2087	60	99	96	99	95	96	93	88	82	100	89	95	97	101	102	100	96	92	86	104	93
2087	50	104	102	104	98	97	94	89	82	102	91	97	102	105	104	101	98	93	86	106	95

Values shown are for inlet L_{wi}A and outlet L_{wO}A sound power levels for installation Type A: Free inlet, Free outlet. The sound power level ratings shown are in decibels, referred to 10⁻¹² watts calculated per AMCA Standard 301. The A-weighted sound ratings shown have been calculated per AMCA International Standard 301. dBA levels are not licensed by AMCA International. The AMCA Certified Ratings Seal applies to L_{wi}A and L_{wO}A values only.

Vektor-MD Size 30 100% Wheel Width

Sound Power by Octave Band																					
Inlet Sound Power												Outlet Sound Power									
rpm	%WOV	1	2	3	4	5	6	7	8	L _w A	dBA	1	2	3	4	5	6	7	8	L _w A	dBA
500	100	83	78	70	72	74	69	56	46	77	65	80	79	77	82	80	69	62	56	83	72
500	80	81	77	69	72	73	70	57	46	76	65	78	80	76	82	80	71	64	56	83	72
500	60	78	77	67	71	73	70	57	46	76	65	79	79	76	82	80	72	64	56	83	72
500	50	86	77	68	71	73	70	57	45	76	65	79	79	76	83	80	72	64	56	84	72
700	100	84	87	79	78	79	75	65	54	82	71	81	83	83	83	84	77	69	58	86	75
700	80	83	84	78	76	77	75	67	53	81	70	81	83	82	81	84	77	71	59	86	75
700	60	81	82	76	75	76	75	68	54	81	69	81	84	81	80	83	78	71	59	86	74
700	50	90	85	77	76	76	75	68	54	81	70	83	85	82	81	83	78	71	59	86	74
1000	100	91	95	87	87	84	83	74	66	90	78	85	91	92	91	89	84	77	67	93	82
1000	80	88	93	84	84	83	78	74	64	87	76	83	88	90	89	88	82	77	66	92	80
1000	60	87	89	82	82	82	78	74	64	86	74	83	86	88	87	87	82	77	66	90	79
1000	50	94	92	85	84	82	78	74	64	87	75	88	90	90	89	88	82	78	66	92	80
1400	100	96	94	100	96	93	90	86	77	99	87	91	93	99	100	96	92	88	78	101	90
1400	80	93	90	96	93	91	86	80	73	95	84	89	90	96	98	94	90	85	76	99	88
1400	60	92	90	92	91	89	85	80	73	93	82	90	91	95	96	92	88	84	76	97	86
1400	50	97	96	96	92	90	86	80	74	95	83	94	96	98	97	94	89	84	76	99	87
1887	100	104	99	108	101	102	97	95	86	106	95	97	100	106	107	105	100	98	88	109	98
1887	80	101	96	104	97	100	95	89	82	103	92	96	97	103	104	103	98	94	86	107	95
1887	60	101	96	101	95	97	93	88	82	101	89	97	99	102	103	101	97	93	86	105	94
1887	50	105	103	105	99	98	94	89	82	103	91	99	103	106	104	102	98	93	86	107	95

Values shown are for inlet L_{wi}A and outlet L_{wO}A sound power levels for installation Type A: Free inlet, Free outlet. The sound power level ratings shown are in decibels, referred to 10⁻¹² watts calculated per AMCA Standard 301. The A-weighted sound ratings shown have been calculated per AMCA International Standard 301. dBA levels are not licensed by AMCA International. The AMCA Certified Ratings Seal applies to L_{wi}A and L_{wO}A values only.

SOUND DATA

Vektor-MD Size 33 100% Wheel Width



Sound Power by Octave Band																					
		Inlet Sound Power										Outlet Sound Power									
rpm	%WOV	1	2	3	4	5	6	7	8	L _{wA}	dBA	1	2	3	4	5	6	7	8	L _{wA}	dBA
500	100	87	85	76	78	75	68	60	52	79	68	75	84	82	83	79	73	64	58	84	73
500	80	89	86	76	77	74	69	61	53	79	68	76	85	82	82	80	74	65	58	84	72
500	60	87	85	75	76	74	69	61	53	79	67	77	86	82	83	80	74	66	58	84	73
500	40	87	86	76	76	74	69	61	53	79	67	77	85	82	83	80	74	66	59	84	73
700	100	87	91	83	81	80	77	67	57	85	73	82	89	86	86	83	78	70	62	87	76
700	80	86	89	81	80	80	77	68	58	84	73	82	88	85	84	83	79	72	63	87	76
700	60	84	86	80	78	79	77	69	58	83	72	83	89	85	83	83	79	72	63	87	75
700	40	86	86	80	79	79	77	69	59	83	72	84	89	86	84	83	79	73	63	87	76
900	100	88	91	86	86	84	80	72	64	88	77	84	90	91	91	87	83	77	68	92	81
900	80	87	89	84	83	82	79	72	63	86	75	82	89	91	90	86	83	77	68	92	80
900	60	88	88	83	81	80	78	72	65	85	73	82	88	89	87	85	83	77	68	90	79
900	40	97	93	87	84	82	79	73	65	87	76	86	90	91	89	86	83	77	69	91	80
1300	100	97	94	102	97	94	90	87	77	100	88	92	94	99	100	95	92	88	81	101	89
1300	80	97	93	101	95	92	88	83	75	98	86	90	92	99	99	94	91	87	81	100	88
1300	60	96	91	98	92	89	86	83	76	95	84	89	92	100	96	91	89	86	80	98	86
1300	40	98	93	98	91	89	86	83	76	95	84	92	95	99	97	93	90	86	80	99	87
1770	100	104	103	110	102	103	98	96	87	107	96	98	102	107	106	104	100	97	91	108	97
1770	80	104	103	109	100	101	97	93	86	106	94	96	100	106	106	103	99	95	91	108	96
1770	60	102	103	105	97	97	94	92	86	103	91	95	99	107	103	99	97	94	90	106	94
1770	40	104	104	106	98	97	94	91	86	103	91	98	103	106	105	101	98	94	91	107	95

Values shown are for inlet L_{wiA} and outlet L_{wO}A sound power levels for installation Type A: Free inlet, Free outlet. The sound power level ratings shown are in decibels, referred to 10⁻¹² watts calculated per AMCA Standard 301. The A-weighted sound ratings shown have been calculated per AMCA International Standard 301. dBA levels are not licensed by AMCA International. The AMCA Certified Ratings Seal applies to L_{wiA} and L_{wO}A values only.

Vektor-MD Size 36 100% Wheel Width

Sound Power by Octave Band																					
		Inlet Sound Power										Outlet Sound Power									
rpm	%WOV	1	2	3	4	5	6	7	8	L _{wA}	dBA	1	2	3	4	5	6	7	8	L _{wA}	dBA
400	100	85	83	75	74	72	63	56	47	76	65	75	82	81	79	77	67	61	54	81	70
400	80	86	83	75	73	72	63	57	48	76	65	77	82	80	78	78	68	61	54	81	69
400	60	85	83	74	72	72	64	57	48	76	64	78	83	81	79	78	69	61	54	81	70
400	40	85	84	74	72	72	64	57	48	76	64	77	83	81	79	78	69	62	54	81	70
600	100	88	90	83	81	80	74	65	55	84	73	85	88	86	84	83	76	68	60	87	75
600	80	86	88	81	80	80	75	66	56	84	72	85	88	85	83	83	77	70	60	86	75
600	60	85	85	79	78	80	74	66	56	83	71	86	88	84	82	83	77	70	60	86	75
600	40	86	85	80	78	80	74	66	56	83	71	86	88	85	82	83	77	71	61	86	75
800	100	88	92	86	86	84	80	71	63	88	77	85	92	92	91	87	83	76	67	92	81
800	80	87	90	84	84	82	78	71	62	86	75	84	90	91	90	87	83	76	67	92	80
800	60	88	89	83	81	81	78	71	64	85	74	84	90	89	86	86	82	76	67	90	78
800	40	97	93	86	85	82	78	72	64	87	76	88	92	91	88	86	82	77	68	91	79
1100	100	95	102	96	96	92	89	84	75	98	86	92	97	98	98	93	90	86	79	99	88
1100	80	95	101	95	94	90	87	81	73	96	84	90	96	98	98	93	89	85	78	99	87
1100	60	95	97	92	91	88	85	81	74	93	82	89	98	97	94	90	87	85	77	96	85
1100	40	97	98	93	91	88	85	81	74	94	82	93	97	98	95	91	88	85	78	97	86
1556	100	105	103	110	103	102	98	95	86	107	96	99	102	106	107	103	99	96	90	108	97
1556	80	105	103	109	101	101	96	92	84	106	94	98	100	106	106	102	99	95	90	108	96
1556	60	103	103	105	98	97	94	91	84	103	91	97	99	107	103	99	97	94	89	105	94
1556	40	105	104	106	98	97	94	91	85	103	91	100	103	106	105	100	98	94	89	106	95

Values shown are for inlet L_{wiA} and outlet L_{wO}A sound power levels for installation Type A: Free inlet, Free outlet. The sound power level ratings shown are in decibels, referred to 10⁻¹² watts calculated per AMCA Standard 301. The A-weighted sound ratings shown have been calculated per AMCA International Standard 301. dBA levels are not licensed by AMCA International. The AMCA Certified Ratings Seal applies to L_{wiA} and L_{wO}A values only.

SOUND DATA

Vektor-MD Size 40 100% Wheel Width



Sound Power by Octave Band																					
Inlet Sound Power												Outlet Sound Power									
rpm	%WOV	1	2	3	4	5	6	7	8	L _w A	dBA	1	2	3	4	5	6	7	8	L _w A	dBA
400	100	88	86	78	77	75	66	59	50	79	68	79	85	84	82	80	70	63	57	84	72
400	80	90	87	78	76	75	66	59	51	79	68	80	86	84	81	81	71	64	57	84	73
400	60	88	86	77	75	75	67	60	51	79	67	81	87	84	82	81	72	64	57	84	73
400	40	88	87	77	75	75	67	60	50	79	67	81	86	84	82	81	72	65	57	84	73
550	100	91	89	83	81	81	74	64	55	84	73	87	87	87	85	83	76	68	60	87	76
550	80	89	87	81	80	81	75	65	56	84	73	88	87	86	84	84	77	70	60	87	76
550	60	86	85	80	78	81	75	66	56	84	72	88	87	85	82	84	77	70	60	87	75
550	40	87	85	80	78	81	75	66	56	84	72	88	88	86	83	84	78	71	61	87	76
750	100	89	94	88	88	85	81	72	64	90	78	88	94	94	92	88	84	77	68	93	82
750	80	88	92	85	85	83	79	72	63	88	76	86	92	93	91	88	84	77	67	93	81
750	60	89	91	84	83	82	79	72	65	87	75	86	92	91	87	87	83	77	68	91	80
750	40	98	95	87	86	83	79	73	65	88	77	90	94	93	89	88	84	77	68	92	81
1000	100	95	103	95	97	93	90	83	75	98	87	94	98	99	98	94	91	86	79	100	88
1000	80	96	102	93	95	91	87	81	73	96	85	92	98	99	98	93	90	86	77	99	88
1000	60	96	98	91	91	88	86	81	74	94	82	91	100	96	94	91	88	85	77	97	85
1000	40	97	99	91	91	88	85	81	74	94	82	95	98	98	95	92	89	85	77	98	86
1414	100	105	103	111	104	103	99	95	86	108	96	101	103	108	107	103	100	96	90	109	97
1414	80	106	102	110	102	101	96	92	84	106	95	99	101	108	107	103	99	95	90	108	97
1414	60	104	102	106	99	97	95	91	84	103	92	98	100	109	104	99	97	94	89	106	95
1414	40	106	103	107	99	97	95	91	85	104	92	101	104	108	105	101	98	95	89	107	96

Values shown are for inlet L_{wi}A and outlet L_{wO}A sound power levels for installation Type A: Free inlet, Free outlet. The sound power level ratings shown are in decibels, referred to 10⁻¹² watts calculated per AMCA Standard 301. The A-weighted sound ratings shown have been calculated per AMCA International Standard 301. dBA levels are not licensed by AMCA International. The AMCA Certified Ratings Seal applies to L_{wi}A and L_{wO}A values only.

Vektor-MD Size 44 100% Wheel Width

Sound Power by Octave Band																					
Inlet Sound Power												Outlet Sound Power									
rpm	%WOV	1	2	3	4	5	6	7	8	L _w A	dBA	1	2	3	4	5	6	7	8	L _w A	dBA
350	100	87	87	80	76	74	64	58	49	79	68	81	86	86	80	80	69	62	56	84	72
350	80	89	88	80	75	75	65	58	49	79	68	82	86	85	80	80	70	63	56	83	72
350	60	87	88	79	74	75	65	58	49	79	68	84	87	85	81	80	70	63	55	84	72
350	40	87	89	79	74	75	65	58	49	79	68	82	86	85	81	80	71	64	56	84	72
500	100	93	88	83	82	82	74	64	56	85	73	90	87	88	85	84	76	68	61	88	76
500	80	90	87	82	80	82	75	65	56	85	73	90	87	87	84	85	77	69	60	88	76
500	60	87	85	81	78	82	75	65	56	84	73	91	87	86	83	85	78	70	60	88	76
500	40	88	85	81	78	82	75	66	56	84	73	91	88	87	83	85	78	70	61	88	76
650	100	89	93	88	87	84	80	70	63	89	78	89	93	94	91	88	83	75	66	93	81
650	80	88	91	85	85	83	78	70	62	87	76	88	92	93	90	88	83	75	66	92	81
650	60	89	90	83	82	82	78	71	64	86	74	88	91	90	86	87	82	75	66	90	79
650	40	96	94	86	86	83	78	71	64	88	77	90	93	92	88	88	83	76	67	92	80
900	100	96	104	96	97	93	90	82	75	99	87	94	100	100	98	94	91	86	79	100	88
900	80	96	103	94	95	91	87	81	73	97	85	92	99	100	98	93	90	86	76	99	88
900	60	96	99	92	92	89	86	81	74	94	83	91	101	97	94	91	88	85	76	97	85
900	40	98	100	92	92	89	86	81	75	94	83	95	99	99	95	92	89	85	77	98	86
1276	100	107	103	111	105	103	99	95	85	108	97	102	104	109	108	104	100	97	90	109	98
1276	80	107	102	110	104	101	97	92	84	107	95	101	102	108	108	103	99	96	89	109	97
1276	60	106	100	107	100	98	95	91	84	104	92	99	102	109	104	100	97	94	89	106	95
1276	40	108	102	107	100	98	95	91	85	104	92	103	105	108	106	101	98	95	89	107	96

Values shown are for inlet L_{wi}A and outlet L_{wO}A sound power levels for installation Type A: Free inlet, Free outlet. The sound power level ratings shown are in decibels, referred to 10⁻¹² watts calculated per AMCA Standard 301. The A-weighted sound ratings shown have been calculated per AMCA International Standard 301. dBA levels are not licensed by AMCA International. The AMCA Certified Ratings Seal applies to L_{wi}A and L_{wO}A values only.

SOUND DATA

Sound Power by Octave Band																					
rpm	%WOV	Inlet Sound Power										Outlet Sound Power									
		1	2	3	4	5	6	7	8	L_{wA}	dBA	1	2	3	4	5	6	7	8	L_{wA}	dBA
300	100	89	80	79	75	73	62	56	47	77	66	84	83	85	80	78	67	61	54	82	71
300	80	91	81	78	74	74	63	56	47	78	66	85	83	84	80	79	68	61	54	83	71
300	60	90	80	78	74	73	64	56	47	77	66	86	83	84	80	79	69	61	54	83	71
300	40	90	80	78	74	73	64	56	46	77	66	85	83	84	80	79	69	62	54	83	71
450	100	94	87	83	82	82	73	63	55	85	74	91	88	89	85	84	76	67	61	88	76
450	80	92	86	82	81	82	74	64	55	85	73	91	87	88	85	85	77	69	60	88	77
450	60	88	84	81	79	82	74	65	56	84	73	91	87	87	84	85	77	69	60	88	76
450	40	88	85	82	79	82	74	65	56	84	73	91	88	87	84	85	78	70	61	88	76
600	100	92	95	89	88	85	80	70	64	90	78	92	96	95	91	89	83	75	67	94	82
600	80	91	92	86	86	84	79	70	63	88	77	90	94	94	90	89	83	76	66	93	82
600	60	91	91	84	84	83	79	71	65	87	76	90	93	91	87	88	83	76	67	92	80
600	40	97	95	88	87	84	79	71	65	89	78	92	95	93	89	89	84	76	67	93	81
850	100	98	105	98	99	94	92	83	76	100	89	96	102	102	100	96	93	87	81	101	90
850	80	98	104	96	97	92	88	82	74	98	87	94	101	102	99	95	91	87	77	101	89
850	60	97	101	94	93	90	87	82	76	96	84	93	102	99	95	93	90	86	78	98	87
850	40	99	101	94	93	90	87	82	76	96	84	97	101	101	97	94	90	86	78	100	88
1170	100	107	112	109	107	103	100	95	86	109	97	104	108	109	109	104	101	97	90	110	99
1170	80	108	111	108	105	101	97	92	84	107	95	103	107	109	109	103	100	96	89	110	98
1170	60	107	108	105	101	98	96	92	85	104	93	101	109	109	105	101	98	95	89	107	96
1170	40	109	109	106	101	98	96	92	85	104	93	105	108	109	107	102	99	96	89	108	97

Values shown are for inlet L_{wI} and outlet L_{wO} sound power levels for installation Type A: Free inlet, Free outlet. The sound power level ratings shown are in decibels, referred to 10^{-12} watts calculated per AMCA Standard 301. The A-weighted sound ratings shown have been calculated per AMCA International Standard 301. dBA levels are not licensed by AMCA International. The AMCA Certified Ratings Seal applies to L_{wI} and L_{wO} values only.

Vektor-MD Dimensions

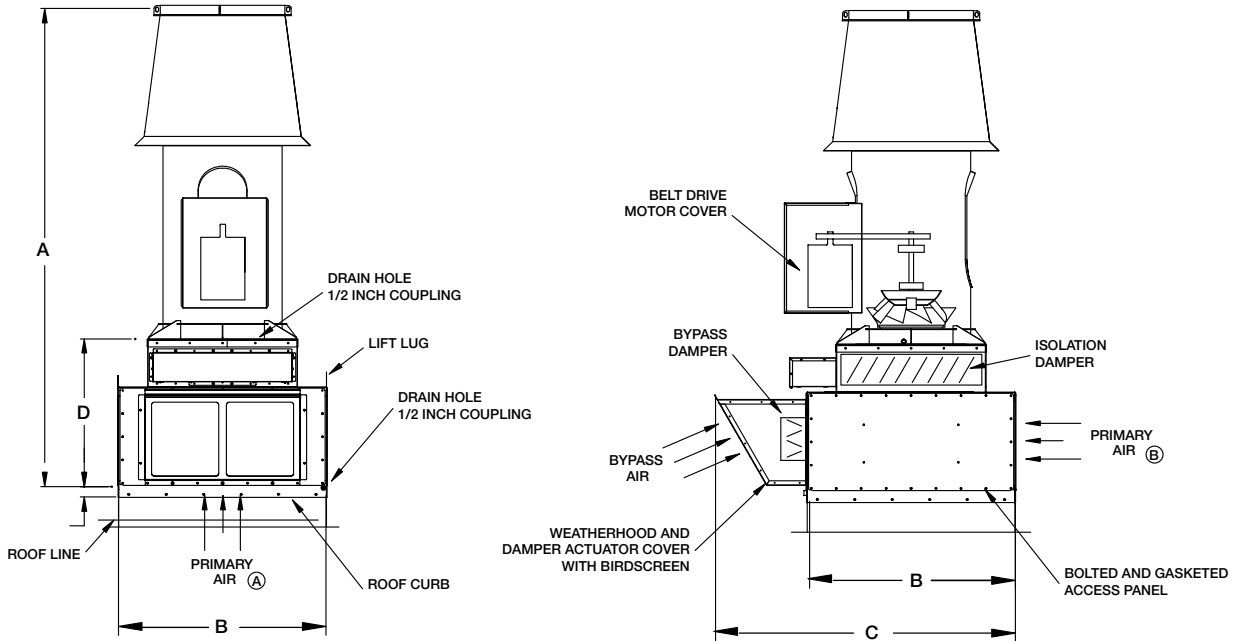

*Weight includes a single-wall bypass air plenum (excludes motor & drives) and roof curb.
 Data shown on this page is for general information only and should not be used for exact installation dimensions. For detailed dimensional data, please refer to the appropriate submittal drawing.

Imperial Units

Size	A (in.)	B (in.)	C (in.)	D (in.)	Roof Curb Height (in.)	High Velocity Windband Exit Diameter (in.)	High Plume Windband Exit Diameter (in.)	Weight (lbs)*
15	117	46.63	73.5	42	12	17.44	26.74	1161
16	119	46.63	73.5	42	12	18.26	27.99	1185
18	139	58.63	88	48	12	21.19	32.49	1592
20	152	58.63	88	48	12	23.51	36.04	1704
22	147	58.63	88	48	12	25.79	39.54	1756
24	155	66.63	96	48	12	28.41	43.56	2145
27	171	66.63	96	48	12	31.41	48.16	2533
30	186	72.63	105	54	12	34.69	53.19	3501
33	178	72.63	105	54	12	38.81	59.51	3796
36	191	86.63	121.5	60	12	42.56	65.26	4942
40	199	86.63	121.5	60	12	46.31	71.01	5292
44	239	100.63	146	84	12	51.19	73.98	7292
49	254	100.63	146	84	12	56.27	81.98	7912

SI Units

Size	A (mm)	B (mm)	C (mm)	D (mm)	Roof Curb Height (mm)	High Velocity Windband Exit Diameter (mm)	High Plume Windband Exit Diameter (mm)	Weight (kg)*
15	2972	1184	1867	1067	305	443	679	527
16	3023	1184	1867	1067	305	464	711	538
18	3531	1489	2235	1219	305	538	825	722
20	3861	1489	2235	1219	305	597	915	773
22	3734	1489	2235	1219	305	655	1004	797
24	3937	1692	2438	1219	305	722	1106	973
27	4343	1692	2438	1219	305	798	1223	1149
30	4724	1845	2667	1372	305	881	1351	1588
33	4521	1845	2667	1372	305	986	1512	1722
36	4851	2200	3086	1524	305	1081	1658	2242
40	5055	2200	3086	1524	305	1176	1804	2400
44	6071	2556	3708	2134	305	1300	1879	3294
49	6452	2556	3708	2134	305	1429	2082	3588

DIMENSIONS

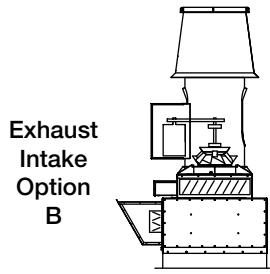

**Vektor-MD Exhaust Intake
Option A
Side View**

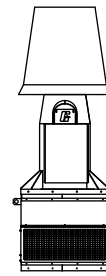

**Vektor-MD 1 x 1
Single Unit System**

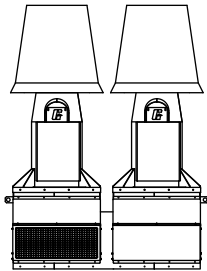

**Vektor-MD 2 x 1
Dual Unit System**

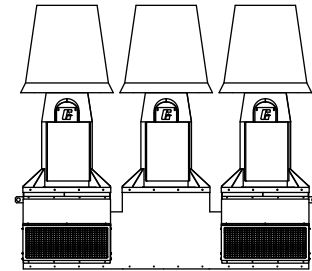

**Vektor-MD 3 x 1
Triple Unit System**

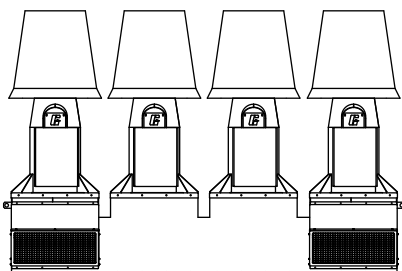

**Vektor-MD 4 x 1
Quad Unit System**

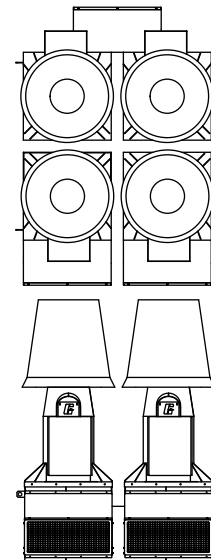

**Vektor-MD 2 x 2
Quad Unit System**

**AMCA
260
Tested**

Family of Lab Exhaust Systems



Other Patents
Pending

Other Patents
Pending

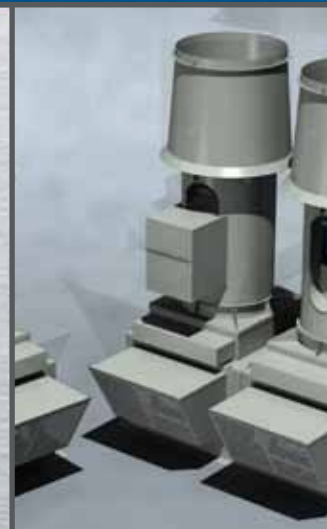

	Vektor-H	Vektor-MD	Vektor-CD
Housing Style	Inline Centrifugal	Inline Mixed Flow	Centrifugal
Stack Style	High Plume Nozzle	High Plume Dilution Nozzle	High Plume Dilution Nozzle
Minimum Flow	270 cfm (459 m ³ /hr)	1,500 cfm (2,549 m ³ /hr)	500 cfm (850 m ³ /hr)
Maximum Flow	24,000 cfm (40,776 m ³ /hr)	80,000 cfm (135,921 m ³ /hr)	140,000 cfm (237,862 m ³ /hr)
Maximum ESP	Up to 3.5 in. wg (875 Pa)	Up to 8 in. wg (2000 Pa)	Up to 14 in. wg (3500 Pa)
 LISTED Underwriters Laboratories	UL/cUL Listed for Electrical 705 (File no. 40001) and UL Listed for Grease Removal 762 Power Ventilators for Restaurant Exhaust Appliances (File no. MH11745)	UL/cUL Listed for Electrical 705 (File no. 40001)	UL/cUL Listed for Electrical 705 (File no. 40001)
AMCA Certification	Sound and Air Performance	Induced Flow Fan Air and Sound Performance	Induced Flow Fan Air and Sound Performance
Warranty	1 Year	3 Years	3 Years
Patents	—	United States: 7320636, 7682231, 7048499 Singapore: 124135, 124106 Mexico: 258949, 243465 P.R. China: 20058006160.6, 01813109.3 Hong Kong: 1114659	United States: 7547249 Singapore: 124105

Our Warranty

Greenheck warrants this equipment to be free from defects in material and workmanship for a period of one year (Vektor-H) or three years (Vektor-MD, Vektor-CD) from the shipment date. Any units or parts which prove defective during the warranty period will be replaced at our option when returned to our factory, transportation prepaid. Should motors furnished by Greenheck prove defective during this period, they should be returned to the nearest authorized motor service station. Greenheck will not be responsible for any removal or installation costs.

As a result of our commitment to continuous improvement, Greenheck reserves the right to change specifications without notice.



Prepared to Support
Green Building Efforts

