

Indoor Air Handling Units

IAH Series

MSCF-FC • MSCF-BI • LFC-FC • VFC-FC • VFCD-FC

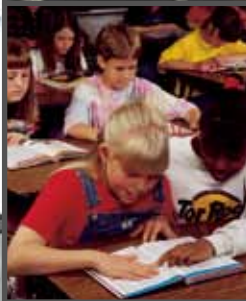

 **GREENHECK**
Building Value in Air.

July
2011

Greenheck's Indoor Air Handling Series, models MSCF, LFC and VFC, provide air conditioning and/or heating for buildings and specific spaces. The series was designed with low-profile construction to fit within tight spaces in applications such as schools, office buildings, apartments, medical facilities and many other commercial applications. Each model has a variety of sizes and a wide performance range with quiet, trouble-free operation.

Modular Indoor Air Handler
Model MSCF-FC
Model MSCF-BI



Modular construction allows the design engineer to configure a unit to meet their exact requirements. The modular construction also makes the MSCF ideal for retrofit applications. (See pages 5 thru 9 for more information.)

Horizontal Fan Coil
Model LFC-FC



A horizontal fan coil unit is ideal for price sensitive applications. The LFC, all-in-one construction, results in a shorter unit which is ideal for space constrained applications. (See pages 10 and 11 for more information.)

Vertical Fan Coil
Model VFC-FC
Model VFCD-FC



A vertical fan coil unit, all-in-one construction, is ideal for providing cooling and/or heating for applications requiring a small footprint. (See pages 12 thru 15 for more information.)

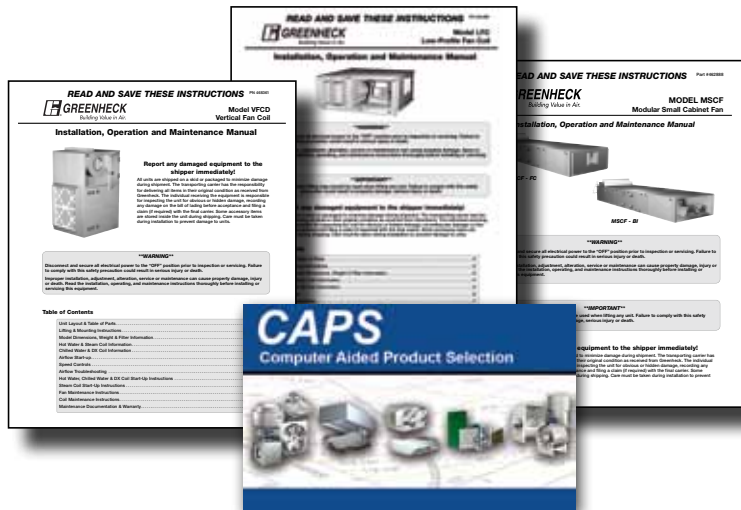

Enjoy Greenheck's extraordinary service, before, during and after the sale.

Greenheck offers added value to our wide selection of top performing, energy-efficient products by providing several unique Greenheck service programs.

- Our Quick Delivery Program ensures shipment of our in-stock products within 24 hours of placing your order. Our Quick Build made-to-order products can be produced in 1-3-5-10- or 15-day production cycles, depending upon their complexity.
- Greenheck's free Computer Aided Product Selection program (CAPS), rated by many as the best in the industry, helps you conveniently and efficiently select the right products for the challenge at hand.
- Greenheck has been Green for a long time! Our energy-saving products and ongoing corporate commitment to sustainability can help you qualify for LEED credits.
- Our 3D service allows you to download, at no charge, easy-to-use AutoDesk™ Revit™ 3D drawings for many of our ventilation products.

Find out more about these special Greenheck services at greenheck.com

Standard Features and Benefits

Greenheck's Indoor Air Handling products have been designed with superior quality and come standard with premium features that make it ideal for any installation.



Low-Profile — Every model has been designed as a space saving alternative to other products on the market. The height of each unit will be 4 to 8 inches less than any competitor model.



Side Access Panels — Units are constructed with easily removable access panels. Panels are formed and positioned on both sides of every module or unit to provide extra rigidity and help maintain cabinet pressure.



One-Inch Double-Wall — Double-wall construction on all units provides excellent indoor air quality as well as improved radiated sound characteristics over traditional single wall and exposed insulation models.



Internal Isolation — Internal neoprene isolation and flexible blower to housing connection is standard on every unit. This isolation improves longevity of the unit and reduces the potential of noise and vibration generated from fan vibration that could be transmitted to the attaching ductwork. Internal spring isolation is also available on all VFC sizes and on MSCF and LFC sizes 20 thru 85.



Drain Pan — The double-wall constructed insulated stainless steel drain pan utilizes a double pitch slope directing condensation to a main or auxiliary drain connection. The pan improves indoor air quality by preventing the growth of mold and bacteria. The drain pan removes easily for coil cleaning.

Model Number Code(s)

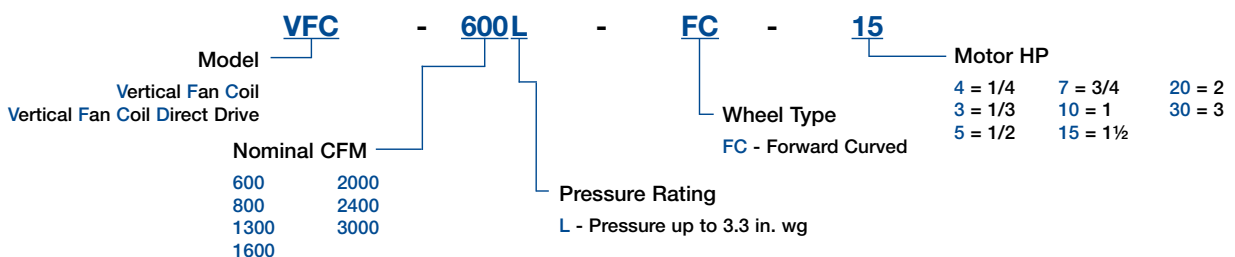
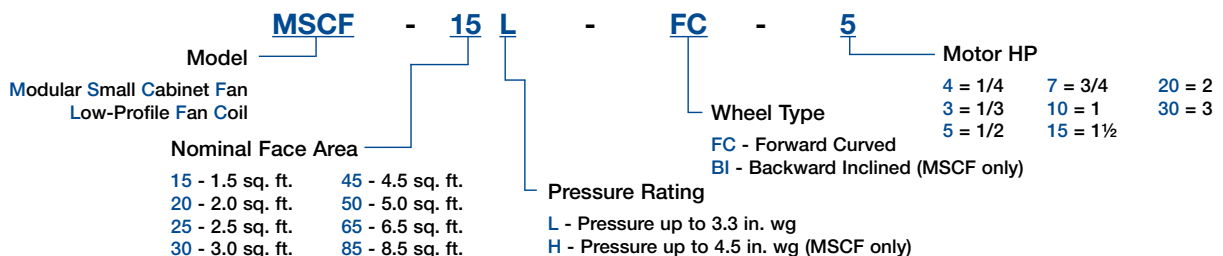

Heating and Cooling Coils — Heating and reheating selections include hot water, steam, or electric. Cooling selections include chilled water or direct expansion. All cooling coils are supplied with a standard insulated double-wall stainless steel drain pan.

Coils	MSCF-FC/BI					LFC					VFC, VFCD				
	1 Row	2 Row	4 Row	6 Row	8 Row	1 Row	2 Row	4 Row	6 Row	8 Row	1 Row	2 Row	4 Row	6 Row	8 Row
HW	x	x	x			x	x	x			x	x	x		
Steam	x	x				x	x				x	x			
CW			x	x	x			x	x	x			x	x	x
DX			x	x	x			x	x	x			x	x	x

Maximum kW Available in Electrical Heat

Unit Size	Model MSCF-FC/BI				
	1 Stage		2 Stage		SCR
	1 Phase	3 Phase	1 Phase	3 Phase	
15	13	14	14	14	14
20	13	19	19	19	19
25	13	40	26.5	40	40
30	13	47.5	26.5	56	56
45	13	47.5	26.5	65	65
50	13	47.5	26.5	65	65
65	13	47.5	26.5	65	65
85	13	47.5	26.5	65	65

Mixing Box — The mixing box module can be configured using any of the three inlet connections (top, bottom and inline or inline, right and left) and three damper styles (“V” blades, low leakage, and airfoil low leakage). The mixing box can also be configured with a filter to reduce overall unit length.



MSCF-FC/BI, LFC-FC

Disconnect Switch — An optional NEMA-1 disconnect switch is available. The J-box is mounted and wired at the factory. The switch is installed in the field.



Control Center — This control center is equipped with a 24-volt starter, transformer, and terminal strip all mounted in a NEMA-1 enclosure. Standard features include an interlocking door disconnect switch and an adjustable electronic thermal overload. This reliable control center reduces installation time, ensures safety and decreases demand on panel space. The control center is UL Listed for Safety for Industrial Control Panels, UL 508A.



Dimensions are 14 x 8.5 x 6.5 inches (355.6 x 215.9 x 165.1 mm) (L x W x H)

Filters — Vertical or sloped filters are available depending on model. Filter efficiency selections include: 30% MERV 8, 65% MERV 11, 95% MERV 15.



MSCF-FC/BI



LFC, VFC, VFCD

Fan Types —

- **Forward-Curved** — Double-width, double-inlet forward-curved blowers are designed to efficiently move high volumes of air with low sound levels. Available on all models and sizes.
- **Backward-Inclined** — A backward-inclined plenum fan is available on the MSCF. Backward-inclined fans are ideal for high-pressure applications across the entire CFM range. Available on MSCF sizes 25 thru 85.



Standard Construction

Model MSCF-FC (Modular Small Cabinet Fan, Forward Curved) and Model MSCF-BI (Modular Small Cabinet Fan, Backward-Inclined) are low-profile, modular constructed small cabinet fans, essentially small air handling units.

- Performance range 300 - 4,700 cfm at 4.5 in. wg
- 1-inch double-wall construction
- Low profile
- Internal isolation (neoprene or spring)
- Internal flex connection
- Side access panels (standard on all modules)
- Stainless steel drain pan (insulated double-wall)

Available Modules

- Pre and/or post filters (vertical and sloped)
- Mixing box
- Mixing box with filter
- Pre and/or post access plenums (12 or 24 inch lengths)
- Heating coils (hot water, steam or electric)
- Cooling coils (chilled water or direct expansion)
- Re-heating coils (hot water or steam)
- Vertical inlet filter
- Inlet damper

Dimensional Data

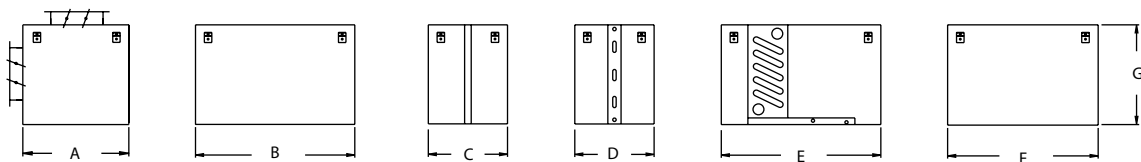

Unit Size	A		B		C		D		E	F	G	Unit Width	Inlet		Outlet	
	No Filter	With Filter	12 in.	24 in.	Per/Post Vertical	Pre/Post Sloped	Hot Water 1 & 2 Row	4 Row HW and Steam					Height	Width	Height	Width
15	11	24½	12¾	24½	12¾	24½	12¾	15½	24½	25	11	38	9	36	4	6¾
20	14	24½	12¾	24½	12¾	24½	12¾	15½	24½	25	14	38	12	36	6½	6¾
25	16	27	12¾	24½	12¾	27	12¾	15½	24½	29	16	38	14	36	8	8½
30	18½	31	12¾	24½	12¾	31	12¾	15½	24½	32	18½	38	16½	36	9	9
45	18½	32	12¾	24½	12¾	32	12¾	15½	24½	32	18½	50	16½	48	9	10
50	21	32	12¾	24½	12¾	32	12¾	15½	24½	38	21	50	19	48	10	10¾
65	26	38	12¾	24½	12¾	38	12¾	15½	24½	42	26	50	24	48	12	12¾
85	26	38	12¾	24½	12¾	38	12¾	15½	24½	42	26	62	24	60	12	15

All dimensions are in inches. For complete dimensional information, see CAPS submittal drawings. Also available as the first module only, is a vertical inlet filter that will add 2 or 4 inches in length to the unit.

MSCF-L-FC



MSCF-15L-FC

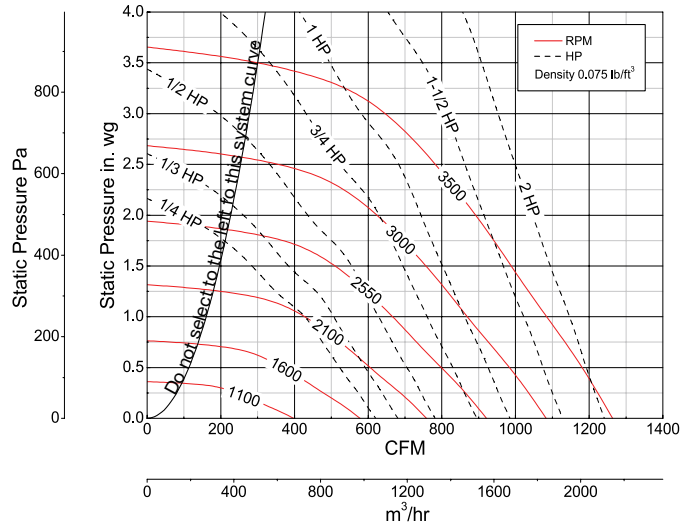

MSCF-20L-FC

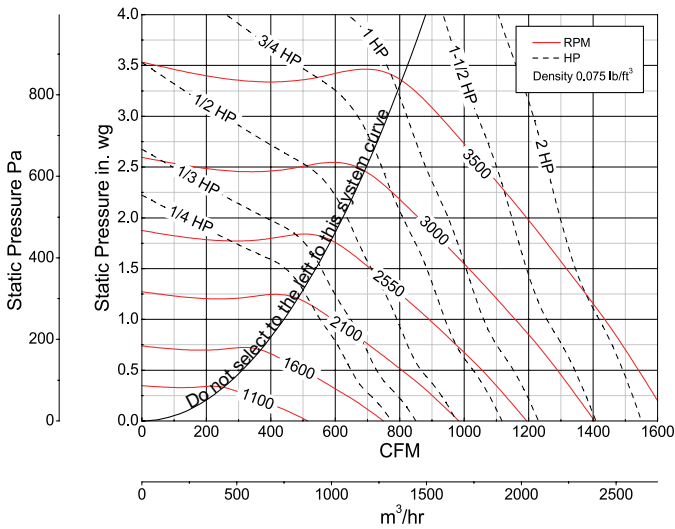

MSCF-25L-FC

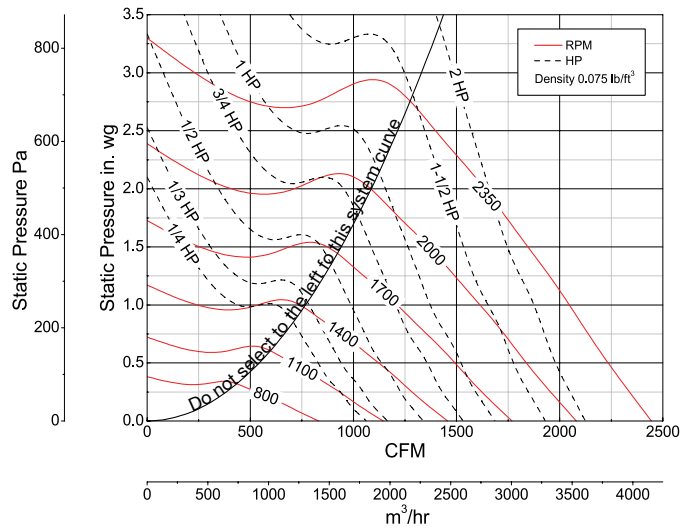

MSCF-30L-FC

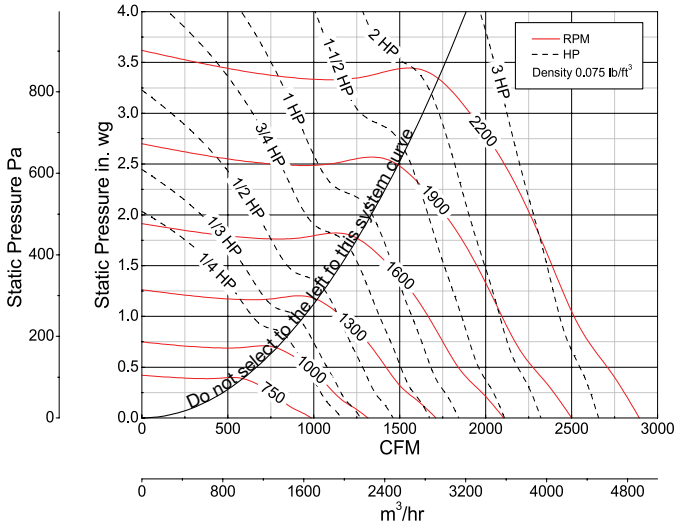

MSCF-45L-FC

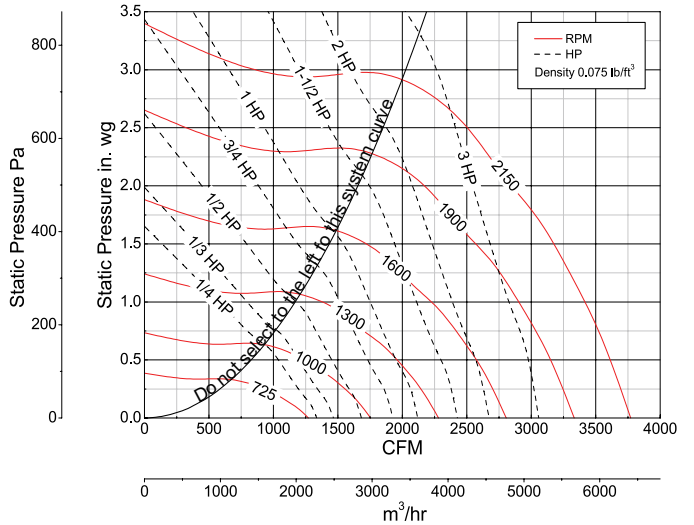

MSCF-50L-FC

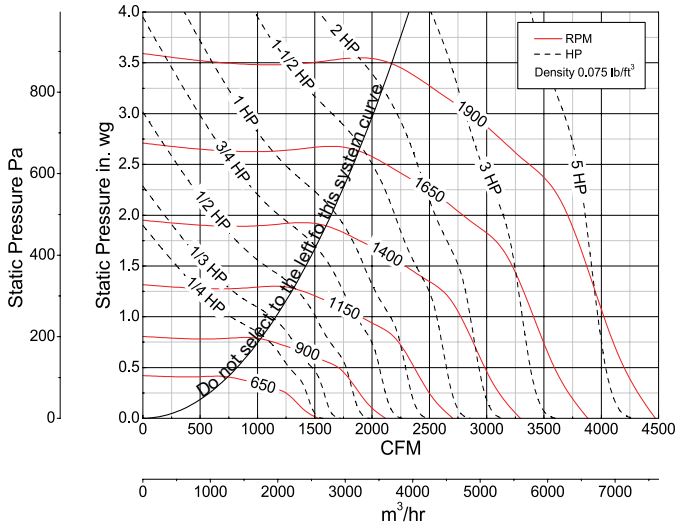

MSCF-65L-FC

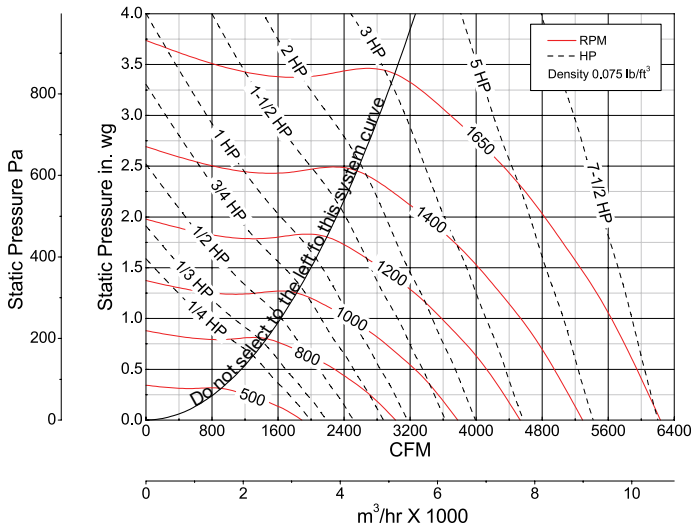

MSCF-85L-FC

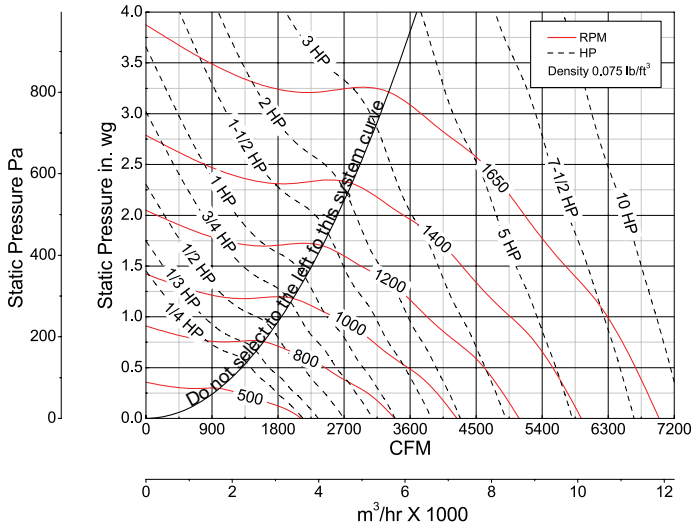

MSCF-H-FC



MSCF-25H-FC

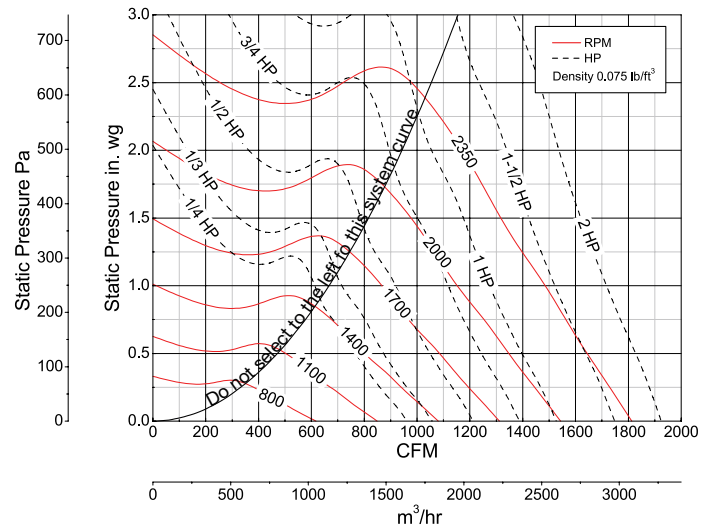

MSCF-30H-FC

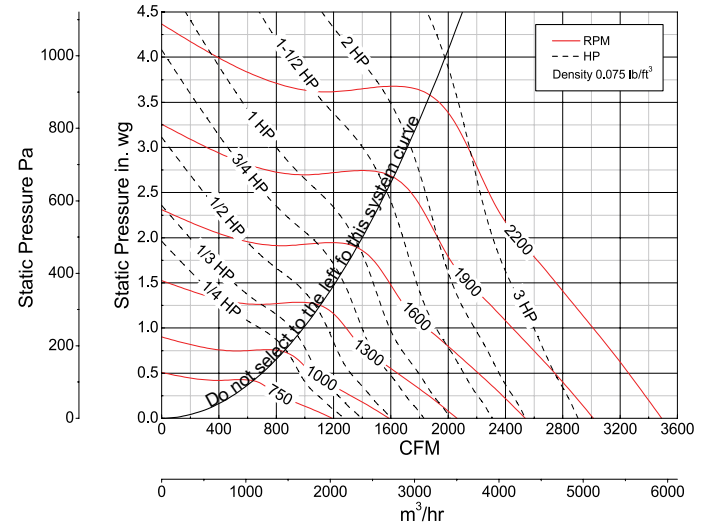

MSCF-45H-FC

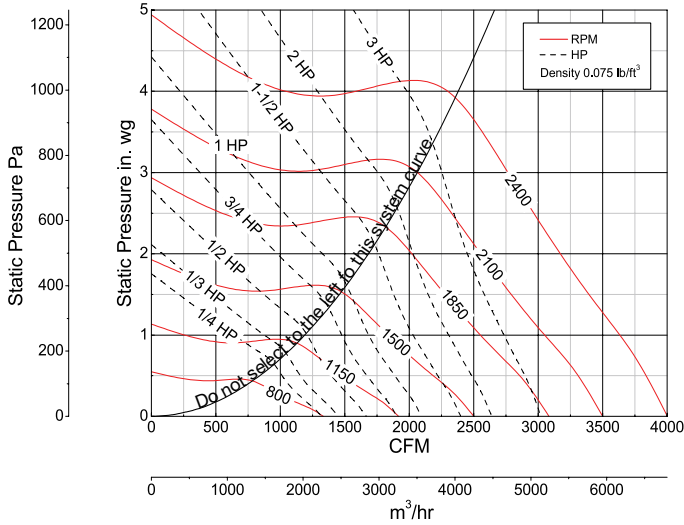

MSCF-50H-FC

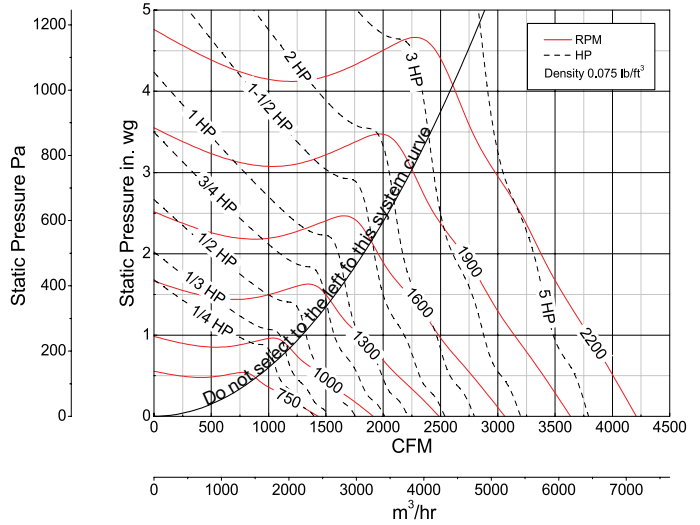

MSCF-65H-FC

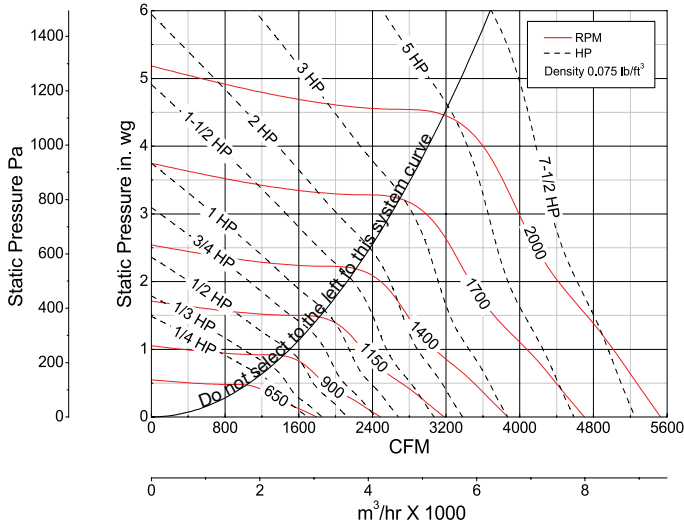

MSCF-85H-FC

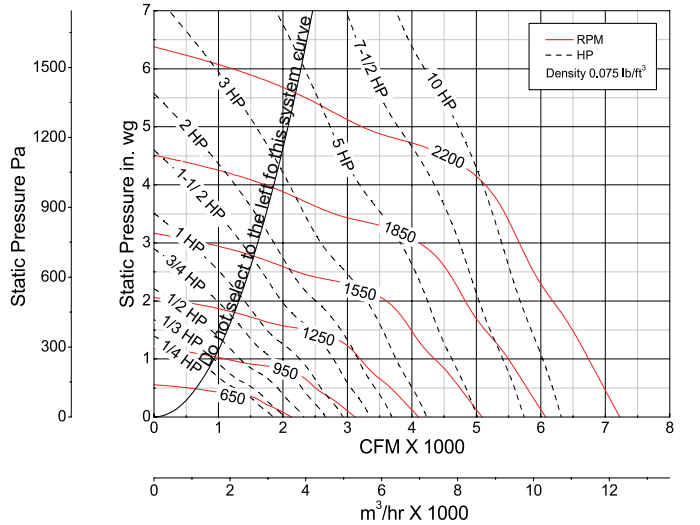

MSCF-BI

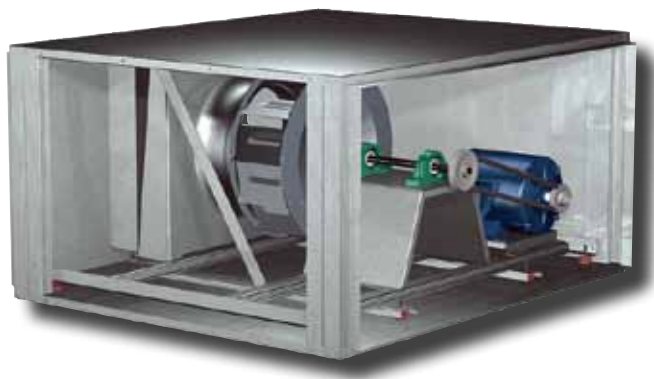

MSCF-25-BI

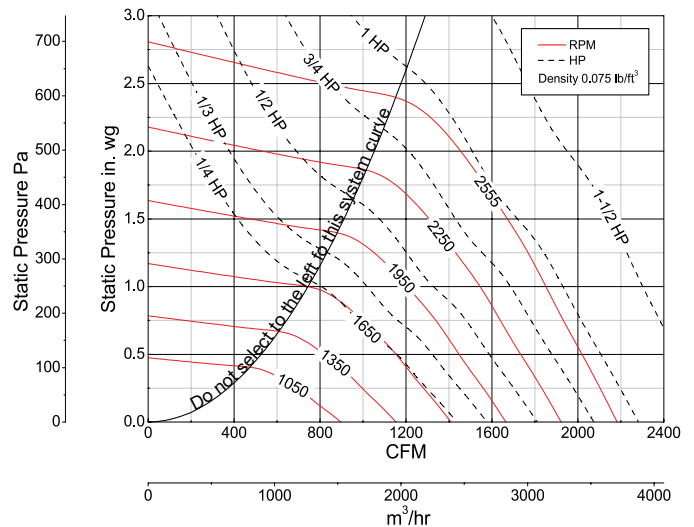

MSCF-30-BI

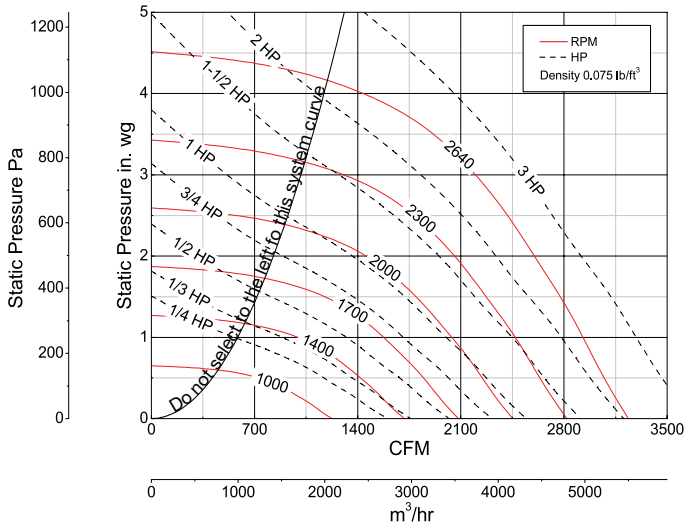

MSCF-45-BI

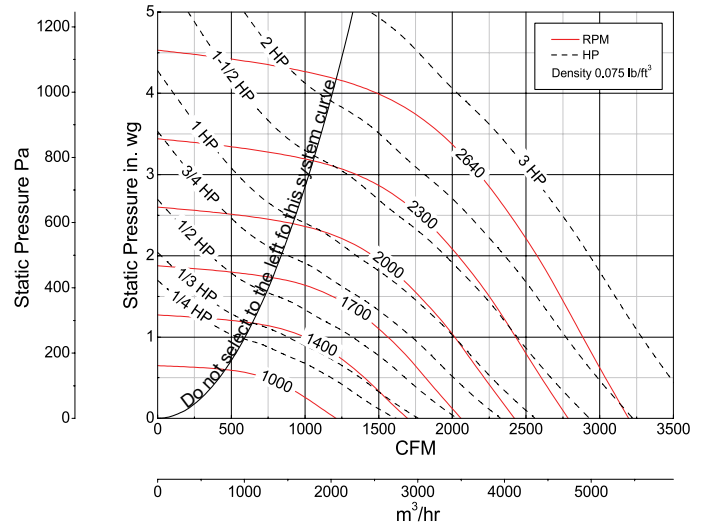

MSCF-50-BI

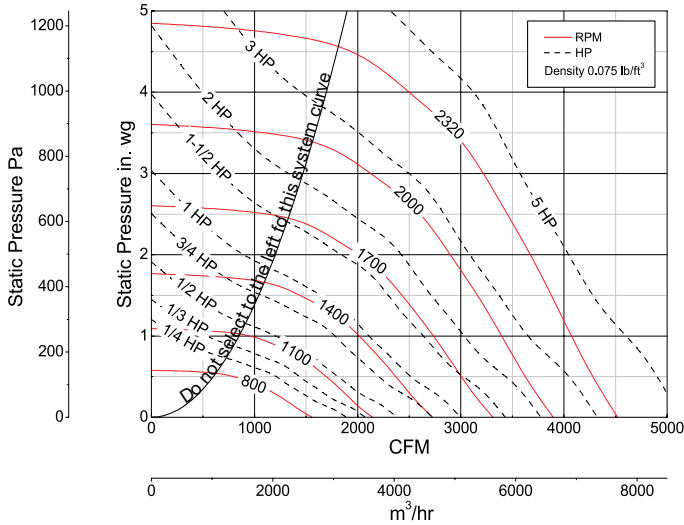

MSCF-65-BI

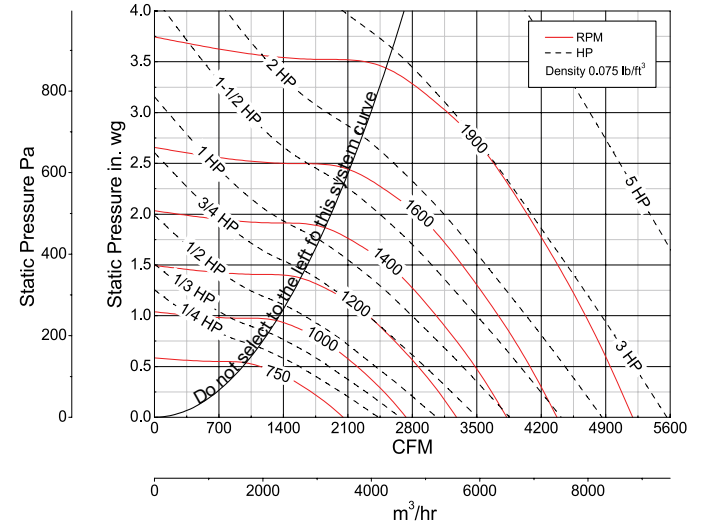

MSCF-85-BI

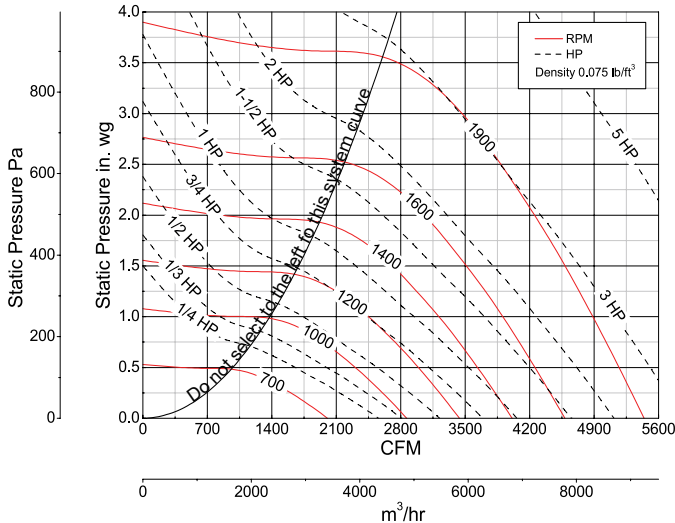

What's This...

Each MSCF modular section maintains its own access panel providing excellent accessibility to all components. All panels have formed edges, which provide additional rigidity and enables the MSCF to maintain cabinet pressure.

Standard Construction

Model LFC (Low-Profile Fan Coil) is a low-profile unit available in eight sizes. Specially designed for a low cost method of air conditioning and/or heating featuring a forward-curved wheel and an option of up to 8 rows of heating and cooling coils.



- Performance range 300 - 4,700 cfm at 3.5 in. wg
- 1-inch double-wall construction
- Low-profile
- Internal isolation (neoprene or spring)
- Internal flex connection
- Side access panels (standard on all models)
- Pre-filter (vertical)
- Heating coils (hot water or steam)
- Cooling coils (chilled water or direct expansion)
- Stainless steel drain pan (insulated double wall)
- Mixing box with filter

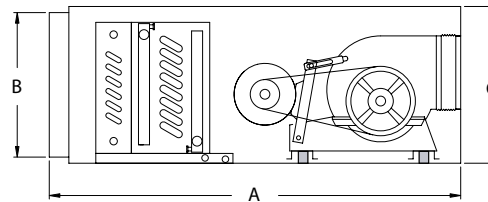

Dimensional Data

Unit Size	A				B	C	Unit Width	Inlet		Outlet	
	No Filter	With 2 in. Filter	With 4 in. Filter	With Mixing Box				Height	Width	Height	Width
15	40	42	44	22½	8	11	38	9	36	4	6¾
20	40	42	44	22½	11	14	38	12	36	6½	6¾
25	40	42	44	25	13	16	38	14	36	8	8½
30	45	47	49	29	15½	18½	38	16½	36	9	9
45	45	47	49	31	14¾	18½	50	16½	48	9	10
50	48	50	52	31	16¾	21	50	19	48	10	10¾
65	52	54	56	37	21¾	26	50	24	48	12	12¾
85	52	54	56	37	21¾	26	62	24	60	12	15

All dimensions are in inches. For complete dimensional information, see CAPS submittal drawings.

Performance

LFC-15L-FC

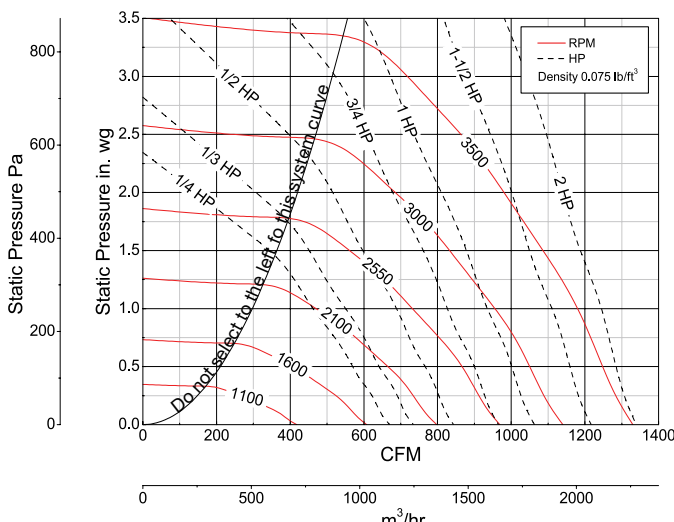

LFC-20L-FC

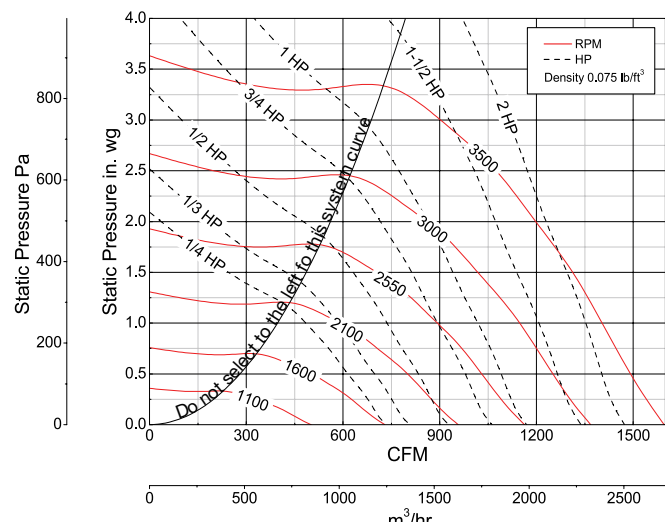

LFC-25L-FC

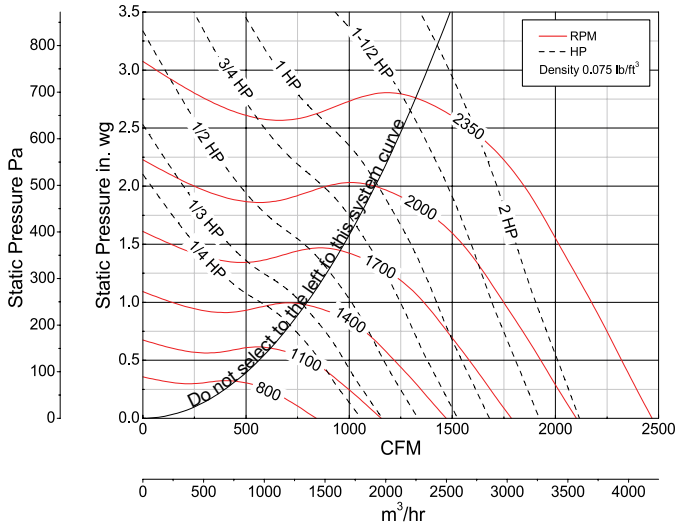

LFC-30L-FC

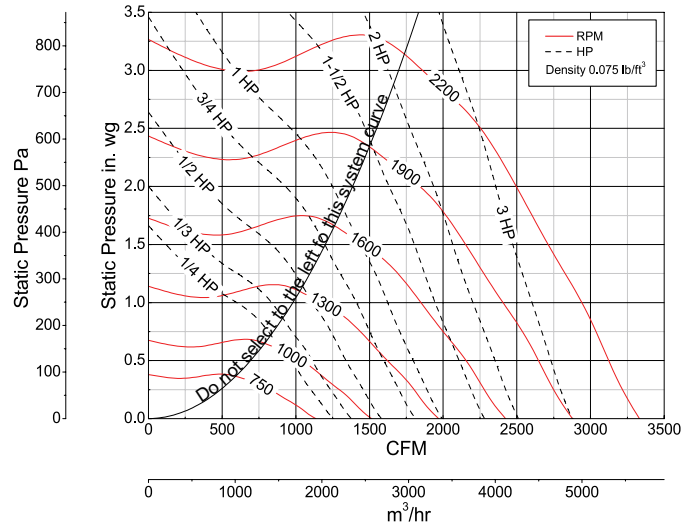

LFC-45L-FC

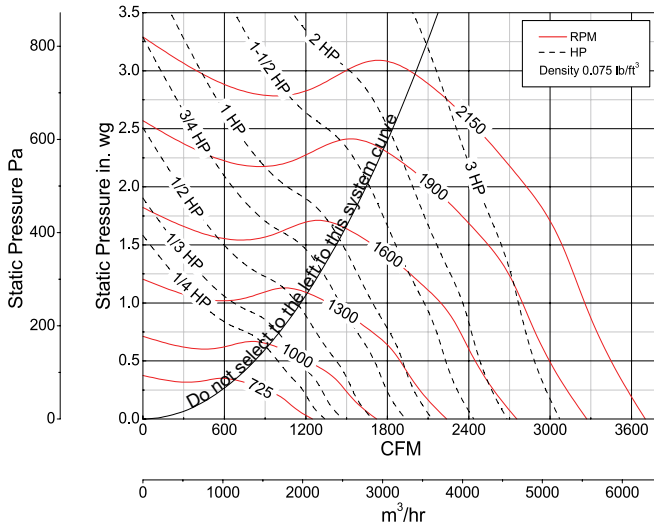

LFC-50L-FC

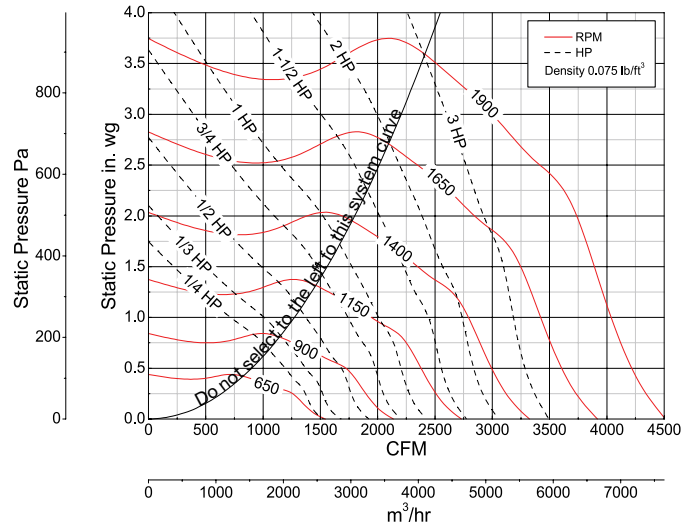

LFC-65L-FC

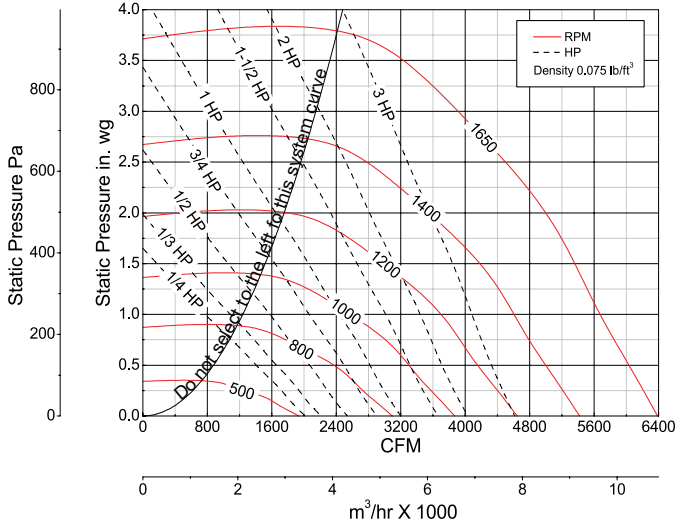

LFC-85L-FC

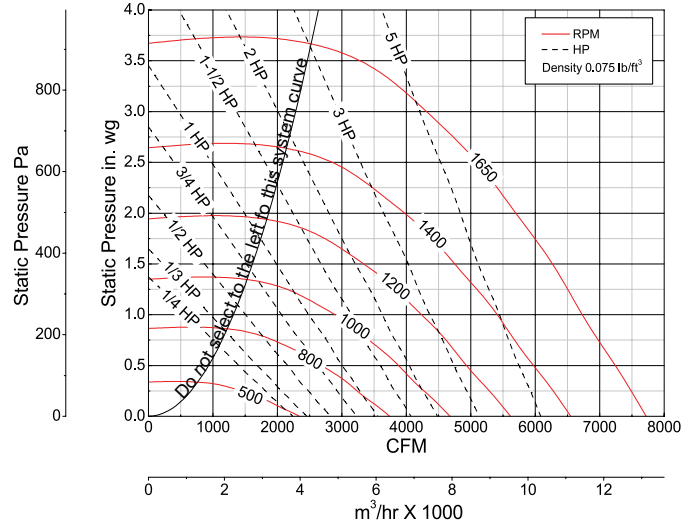

Standard Construction

Model VFC (Vertical Fan Coil) is a vertical, low cost, forward-curved fan coil unit available in seven sizes. Up to 8 rows of heating and cooling coils for sizes 600-800 and up to 10 rows for sizes 1300-3000 are available.



- Performance range 300 - 4,000 cfm at 3.5 in. wg
- 1-inch double-wall construction
- Internal isolation (neoprene or spring)
- Internal flex connection
- Side access panels (standard on all models)
- Hinged access to blower
- Pre-filter (vertical)
- Heating coils (hot water or steam)
- Cooling coils (chilled water or direct expansion)
- Stainless steel drain pan (insulated double wall)

Dimensional Data

Unit Size	A	B	C	Inlet		Outlet	
				D	E	F	G
600	40	24	24	18	22	6¾	4
800	40	24	24	18	22	6¾	6½
1300	44	24	28	18	22	8½	8
1600	44	30	28	22	22	9	9
2000	52	34	28	29	23	10	9
2400	52	34	28	29	23	10¼	10
3000	52	50	32	45	22	12¾	12

All dimensions are in inches. For complete dimensional information, see CAPS submittal drawings.

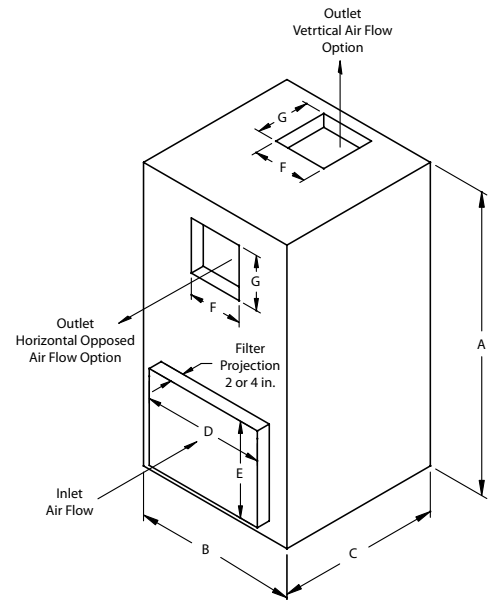

Performance

VFC-600L-FC

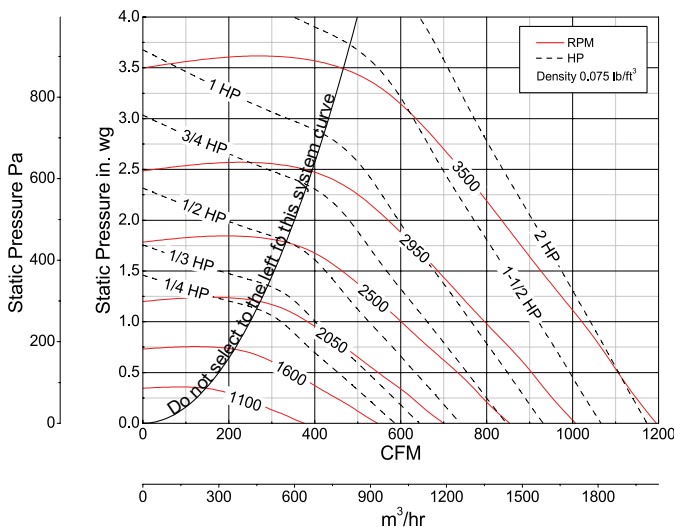

VFC-800L-FC

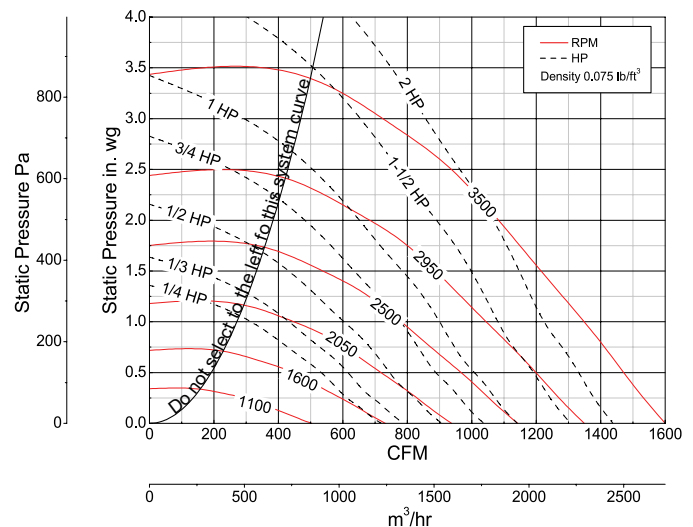

VFC-1300L-FC

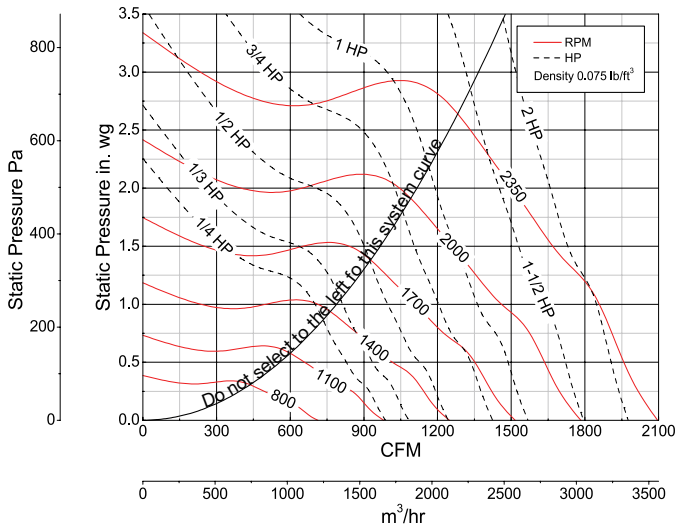

VFC-1600L-FC

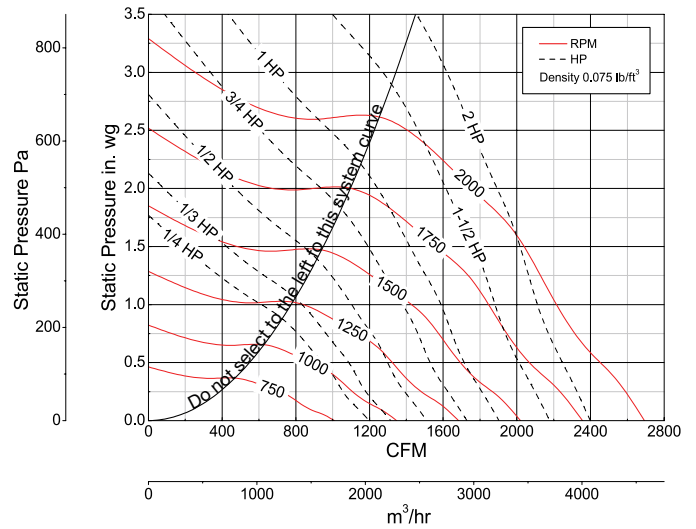

VFC-2000L-FC

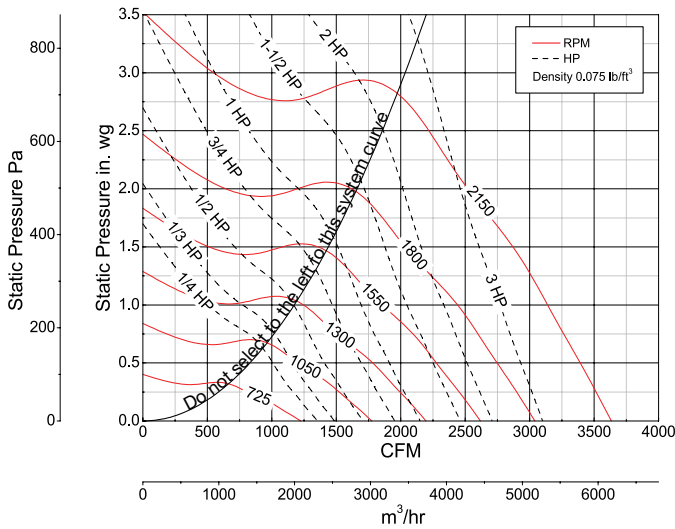

VFC-2400L-FC

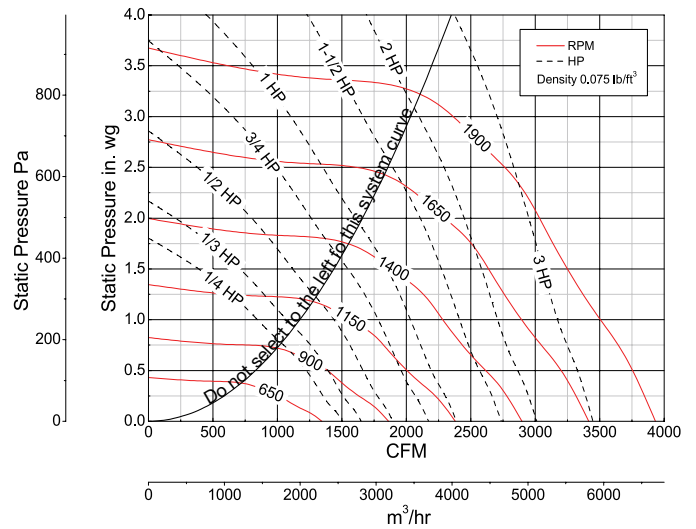

VFC-3000L-FC

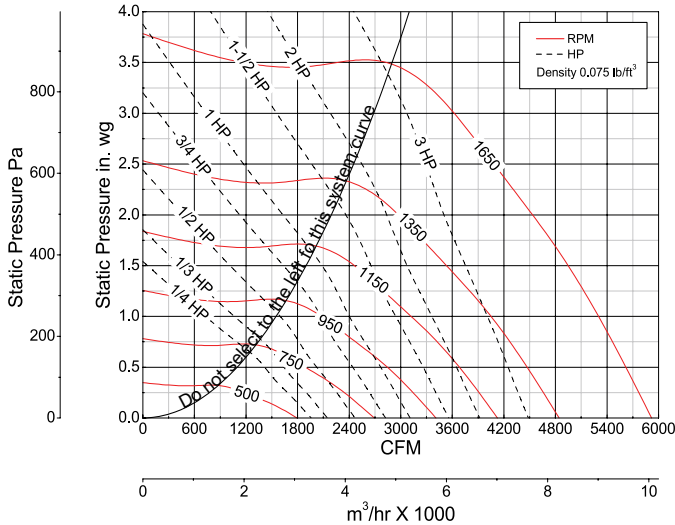

What's This...

Belt drive fans offer the ability to adjust fan speed for system balancing if necessary. They also offer more flexibility in speed and motor selections than direct drive fans.

Standard Construction

Model VFCD (Vertical Fan Coil - Direct Drive) is a vertical, low cost, forward-curved fan coil unit available in seven sizes. Up to 8 rows of heating and cooling coils for sizes 600-800 and up to 10 rows for sizes 1300-3000 are available. The motor and scroll assembly can be slid out and easily removed for accessibility.

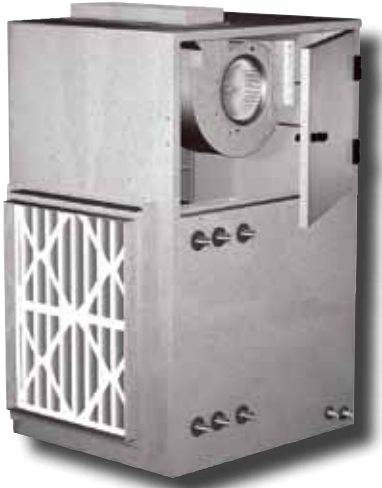

- Performance range 300 - 4,000 cfm at 2.0 in. wg
- 1-inch double-wall construction
- Side access panels (standard on all models)
- Pre-filter (vertical)
- Hinged access to blower
- Heating coils (hot water or steam)
- Cooling coils (chilled water or direct expansion)
- Dual pitched stainless steel drain pan (insulated double wall)

Dimensional Data

Unit Size	A	B	C	Inlet		Outlet	
				D	E	F	G
600	40	24	24	18	22	5½	5½
800	40	24	24	18	22	5½	7¼
1300	44	24	28	18	22	5⅝	18
1600	44	30	28	22	22	5⅝	18
2000	52	34	28	29	23	5⅝	26
2400	52	34	28	29	23	5⅝	26
3000	52	50	32	45	22	10⅜	32⅞

All dimensions are in inches. For complete dimensional information, see CAPS submittal drawings.

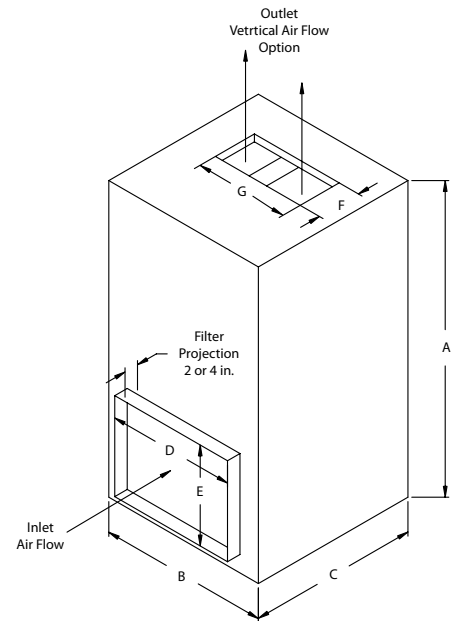

Performance

VFCD-600L-FC

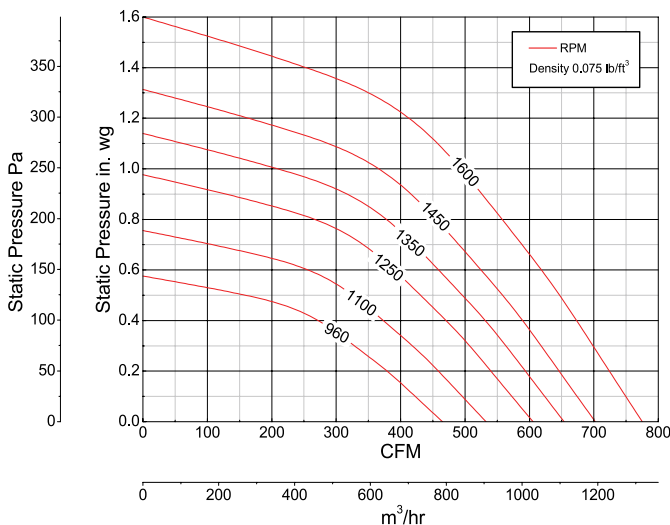

VFCD-800L-FC

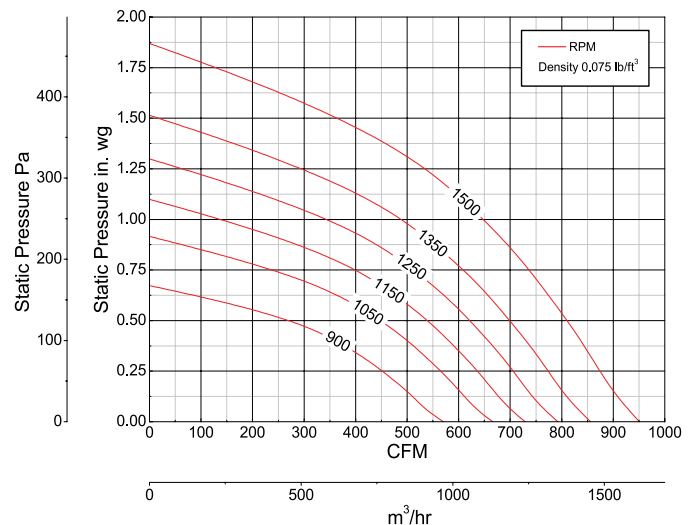

VFCD-1300L-FC

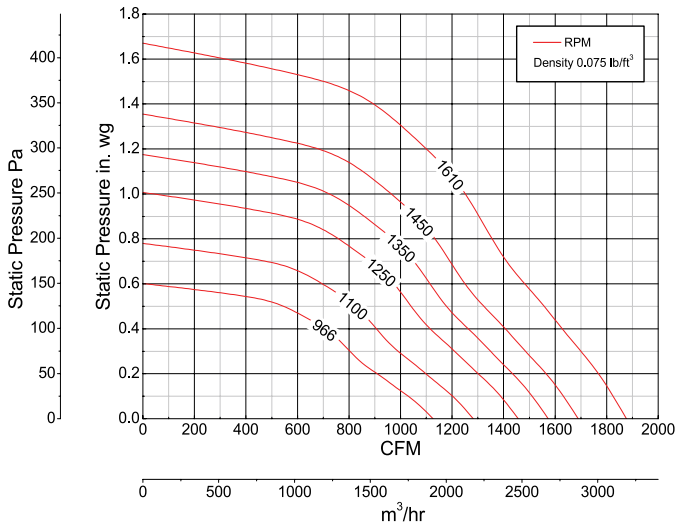

VFCD-1600L-FC

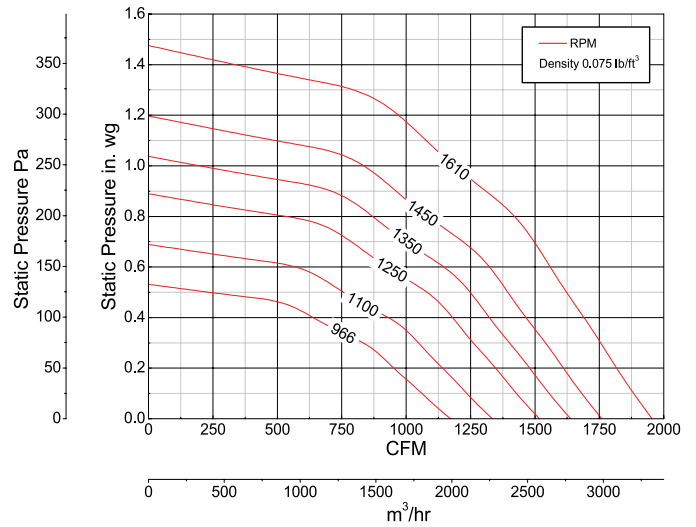

VFCD-2000L-FC

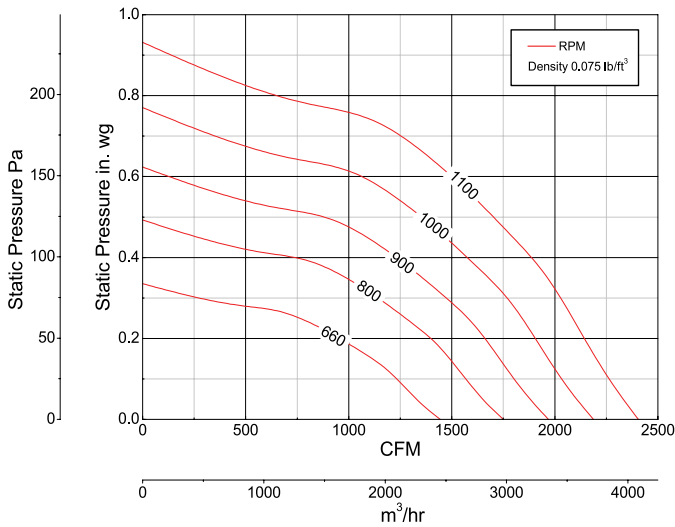

VFCD-2400L-FC

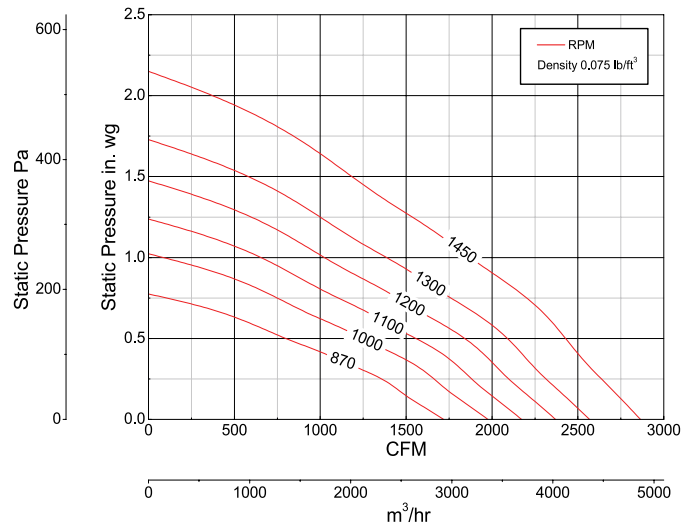

VFCD-3000L-FC

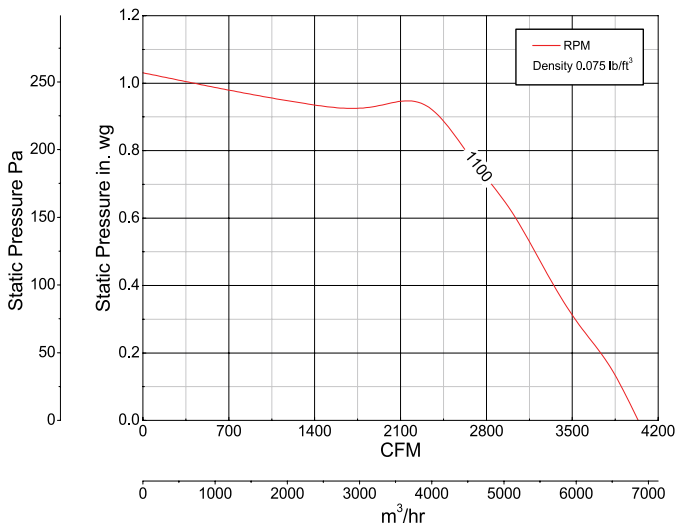

What's This...

An optional 10 Amp solid state speed control is available on VFCD sizes 600-FC thru 2400-FC. Model 10WSSC speed control will ship with the unit, mounted in the factory mounted J-Box.



Product Characteristic Comparison

Model	MSCF	LFC	VFC/VFCD
Drive	Belt	Belt	Belt, Direct
Fan Type	FC, BI	FC	FC
Typical Application	Space Constrained	Space Constrained	Small Footprint
Cabinet Design	Horizontal	Horizontal	Vertical
Cabinet Material	Galvanized 18 ga	Galvanized 18 ga	Galvanized 18 ga
Normal SP Range	0 - 4.5 in. wg	0 - 3.5 in. wg	0 - 3.3 in. wg
Filters	30%, 65%, 95%	30%, 65%	30%, 65%
Insulation Density	1.5 lb., 3 lb.	1.5 lb., 3 lb.	1.5 lb., 3 lb.
Construction	Double Wall	Double Wall	Double Wall
Ducted/Unducted	Ducted	Ducted	Ducted
Nominal cfm Range	800 - 4,700	800 - 4,700	600 - 4,000
Heating/Cooling	Either, Both	Either, Both	Either, Both
Mounting Brackets	Hanging, Base	Hanging, Base	6 in. Extended Base
Disconnect Switch	NEMA-1 Control Center	NEMA-1 Control Center	NEMA-1 Control Center
Pre/Post Plenums	12, 24 inch	N/A	N/A
Mixing Box	Yes	Yes	No



Building Value in Air

Greenheck delivers value to mechanical engineers by helping them solve virtually any air quality challenges their clients face with a comprehensive selection of

top quality, innovative air-related equipment. We offer extra value to contractors by providing easy-to-install, competitively priced, reliable products that arrive on time.

And building owners and occupants value the energy efficiency, low maintenance and quiet dependable operation they experience long after the construction project ends.

Our Warranty

Greenheck warrants this equipment to be free from defects in material and workmanship for a period of one year from the shipment date. Any units or parts which prove defective during the warranty period will be replaced at our option when returned to our factory, transportation prepaid. Motors are warranted by the motor manufacturer for a period of one year. Should motors furnished by Greenheck prove defective during this period, they should be returned to the nearest authorized motor service station. Greenheck will not be responsible for any removal or installation costs.

As a result of our commitment to continuous improvement, Greenheck reserves the right to change specifications without notice.

