

PD2-6060

Helios Dual-Input Process Meter

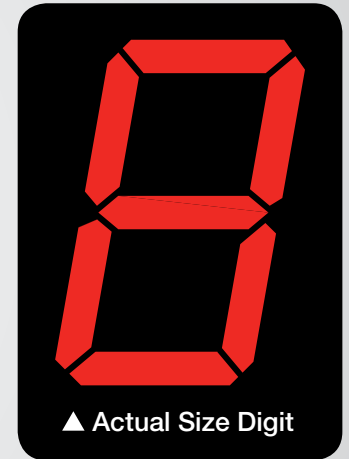

HELIOS



**DUAL-INPUT
PROCESS**

- Dual-Input Process Meter with Math Functions
- Addition, Difference, Average, Multiplication, Division, Min, Max, Weighted Average, Ratio, Concentration, & More
- Large 1.80" Dual-Line 6-Digit Display Readable from up to 100 Feet Away
- Superluminous Sunlight Readable Display
- Displays Two Process Inputs Simultaneously
- NEMA 4X, IP65 Rated Field Mountable Enclosure
- Two (2) 0-20 mA, 4-20 mA, 0-5 V, 1-5 V, and ± 10 V Inputs
- Universal 85-265 VAC, or 12-24 VDC Input Power Models
- Isolated 24 VDC @ 200 mA Transmitter Power Supply
- Programmable Display & Function Keys
- 32-Point, Square Root, or Exponential Linearization
- Multi-Pump Alternation Control
- Four (4) Relays + Isolated 4-20 mA Output Option
- External 4-Relay, Dual Analog Output, and Digital I/O Expansion Modules
- Onboard USB & RS-485 Serial Communication Options
- Modbus[®] RTU Communication Protocol Standard
- On-Board Digital Input
- Program the Meter from a PC with Onboard USB and MeterView[®] Pro

PRECISION DIGITAL CORPORATION

**PRECISION
DIGITAL** 
www.predig.com

PD2-6060 Helios Dual-Input Process Meter

NEMA 4X, IP65
Rated Enclosure



UV Resistant
Sunlight Readable Display



Extra-Large
1.8" Digits

User Configurable
Display (Showing
math function result)

Dual-Line
6-Character
Display

User Configurable
Display (Showing
Custom Tag)

Alarm Status
Indicators

Connections and
Function Keys Easily
Accessible Behind
Front Panel Door.



ADVANCED, VERSATILE, & CUSTOMIZABLE

The Helios PD2-6060 meter combines two independently programmed analog inputs with powerful math functions to make an advanced meter capable of handling complex math requirements common in the process industry. Various math functions may be applied to the inputs including addition, difference, average, multiplication, division, ratio, and more. A customizable dual-line display allows a wide variety of input variables, math calculations, or units and tags to be displayed based on your application needs.

KEY FEATURES

The PD2-6060 meter is the mathematician of the Helios family. Its two process input channels and math functions make it unique while still maintaining all the great features of the Helios family.

Dual-Input Process Meter

The PD2-6060 has two process input channels (A & B) capable of accepting current (0-20, 4-20 mA) and voltage (± 10 , 0-5, 1-5, 0-10 VDC). Each input is programmed separately, with independent input type selection and scaling. These inputs may be displayed individually as part of the customizable dual-line display, or used with a wide range of math functions. Each input has a custom unit or tag that may be displayed. A 24 V transmitter power supply is standard and may be used to power the inputs.

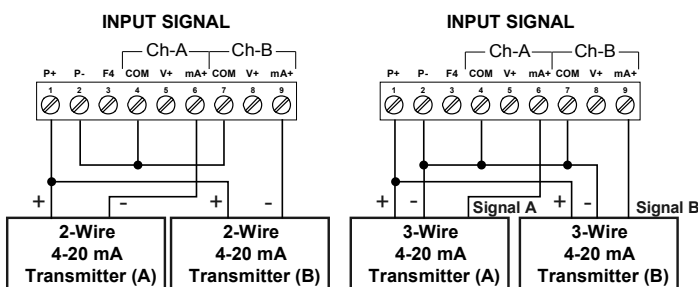

Powerful Math Functions

The PD2-6060 uses two process input channels (A & B) in a variety of powerful math functions designed for a wide range of process applications. Programmable adder (P) and factor (F) constants allow each formula to be customized as needed for a specific application. The math function (C) may be displayed with units, tags, channel A or B, and in other useful combinations.

Name	Function	Setting
Addition	$(A+B+P)*F$	Summ
Difference	$(A-B+P)*F$	dif
Absolute diff.	$((\text{Abs}(A-B))+P)*F$	difAbs
Average	$((A+B)/2+P)*F$	Avg
Multiplication	$((A*B)+P)*F$	mult
Divide	$((A/B)+P)*F$	div
Max of A or B	$((\text{AB-Hi})+P)*F$	Hi
Min of A or B	$((\text{AB-Lo})+P)*F$	Lo
Draw	$((A/B)-1)*F$	draw
Weighted Avg.	$((B-A)*F)+A$	WtAvg
Ratio	$(A/B)*F$	ratio
Ratio 2	$(A/B)*F$	ratio2
Concentration	$(A/(A+B))*F$	ConcEn

Note: The F constant can be any value from 0.00001 to 999999. If the value is less than 1, it will have the same effect as a divider. For example, the average could also be derived by using $(A+B)*F$, where $F = 0.500$.

Superluminous Sunlight Readable Display

PD2-6060's standard SunBright display features extraordinarily bright LEDs. It is perfect for applications where the meter is in direct sunlight or in applications where visibility may be impaired by smoke, fog, dust, or distance.

Precise, Accurate, and More Informative

The Helios' large 1.8" display provides a highly accurate and precise dual line, 6-digit view of the process measurement. Its 24-bit A/D is accurate to $\pm 0.03\%$ of calibrated span ± 1 count.

PD2-6060 Helios Dual-Input Process Meter

Customizable Displays

The Helios has two red LED displays, one Upper display and one Lower display both at 1.8" high. Each display is a full 6 digits (-99999 to 999999). The displays can be set up to read input channels (A or B), math function channel C, toggle between A & B, B & C, A & C, A & B & C, toggle between channels A, B, or C & units, the max/min of any of the channels, including the math channel (C), set points, gross (without tare) or net (with tare) & gross values of channel A or B, or the Modbus input. This allows the display to be setup to display whatever variables are most valuable to the application. Here are just a few examples.



Math Function & Tag

The Upper display shows the math function result (C). The Lower display shows a custom label, in this case the math function used.



Math Function & Inputs A & B

The Upper display shows the math function result (C). The Lower display alternates between channels A and B, with an indicator for each when being displayed.



Input Channels A & B

Both input channels are displayed, input A on the Upper display and input B on the Lower display. Indicators show A or B to label the display.

Max/Min Display

Max/Min (or Peak/Valley) is standard on the PD2-6060. Either display can be configured to show either maximum or minimum excursion since last reset. The displays can be configured to toggle between Max and Min values. Any of the F1-F3 function keys (buttons) and the digital inputs can be programmed to reset the max & min readings.

Easy to Program

The user friendly dual-line display makes the PD2-6060 easy to set up & program with its programming buttons located behind the front door panel. There are three levels of password protection to help maintain the integrity of the programming and there are no jumpers to set for the meter input selection.



Input Setup



Display Setup

Alternation Display

Certain display options alternate the display information. A single display can show input variable information as well as that channel's unit or tag. Input and math function channels, gross and net values, and select inputs and the math result may also alternate on a single display. Below are just a few of the options for setting up a single display to alternate information.

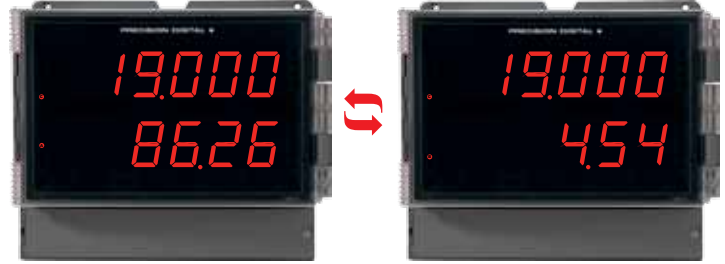

Lower Display Alternating Input Channels A & B



Both Displays Alternating Input Value and Unit

Advanced Linearization Capability

The Helios includes a 32-point linearizer for each input. In non-linear level applications (i.e. some pumping or lift stations), it can easily compensate for submerged equipment or plumbing that displace usable volume. In addition to the 32-point linearization, the Helios can perform a square root or programmable exponent function on one or both inputs, or automatically calculate level in round horizontal tanks by inputting the length and height of the tank. Each input's linearization is performed independently prior to the input value being used in any math function. Precision Digital's free MeterView Pro PC-based software greatly simplifies the construction of the linearization tables. The software can save this data to the meter and/or PC.

On-Board Digital Input

The PD2-6060 includes a digital input as standard. This digital input can operate with the tare, reset tare, or interlock relays feature, force relays on from a signal from a PLC or relay on other equipment, and much more. This is ideal for installations where the meter is inaccessible behind a cover, or where an additional function key is needed for customized operation.

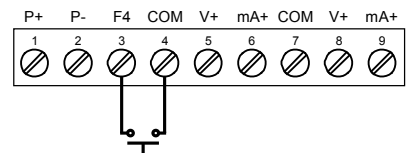

Rounding

The rounding feature is used to give the user a steadier display with fluctuating signals. It causes the display to round to the nearest value according to the rounding value selected (1, 2, 5, 10, 20, 50, or 100). For example, with a rounding value of 10, and a input of 12346, the display would indicate 12350.

PD2-6060 Helios Dual-Input Process Meter

Free USB Programming Software

The Helios comes with free programming software that connects to your PC with a standard USB cable that is provided with each instrument. A new and very useful feature of this software is that it is resident on the Helios meter and installed directly into your PC. This eliminates the need to install drivers or download software from the internet. Just connect the Helios to your PC (the Helios even gets its power from the PC so you don't have to provide external power!) and within minutes you will be programming it with the free software.



MOUNTING OPTIONS

Pipe Mounting Kit

The meter can also be mounted to a pipe using the optional pipe mounting kit (PDA6260). This kit includes two mounting plates, two U-bolts, and the necessary nuts and bolts. See PD2-6060 manual for instructions.

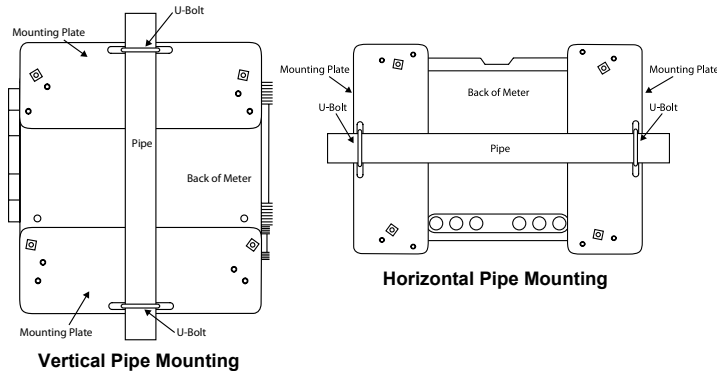

Wall Mounting

The meter can be mounted to any wall using the four provided mounting holes. Note that the bottom mounting holes are located behind the front door panel. See manual for instructions.

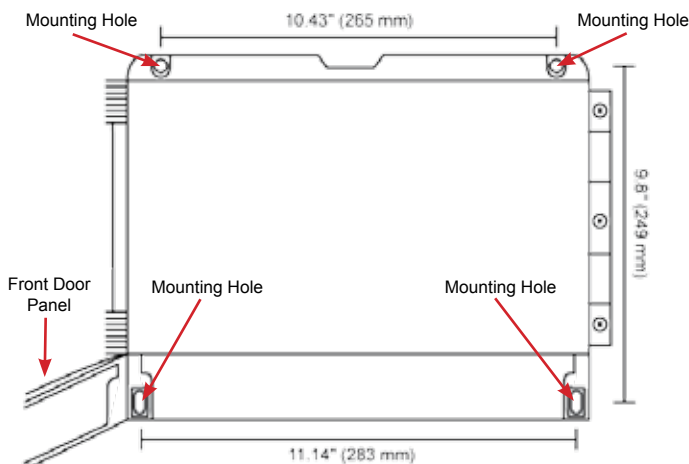

METERVIEW® PRO SOFTWARE

Configure, monitor, and datalog a PD2-6060 from a PC using Meter View Pro Software (available with each Helios meter via USB or for download at www.predig.com).

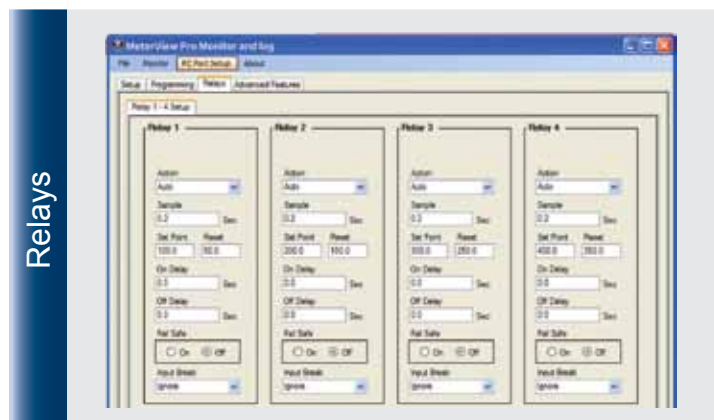
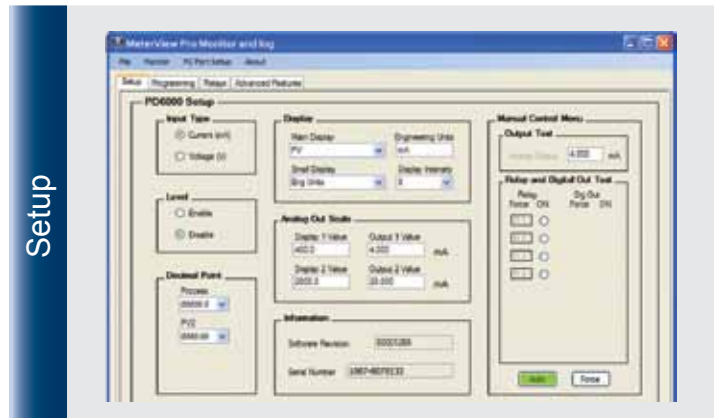
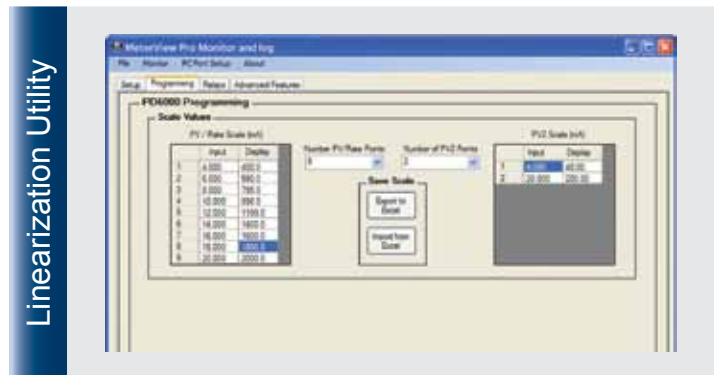
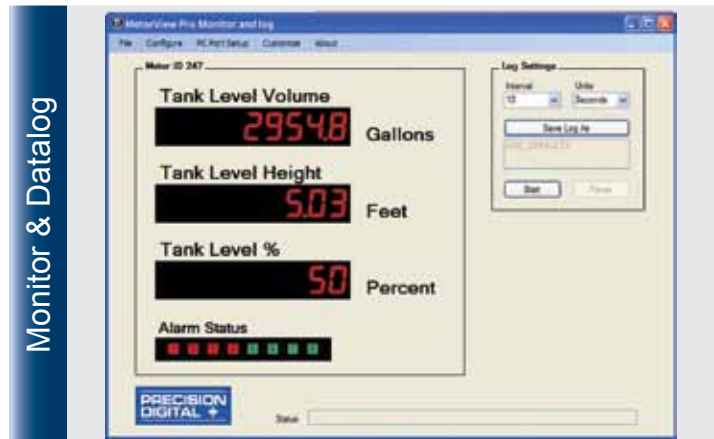

OUTPUTS

Relay Outputs

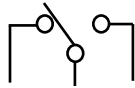

The Helios has up to four 3 A Form C relays (SPDT) with multiple power loss fail-safe options. Each relay may be assigned to input channel A or B, or math result (C). Relays can be configured for proper protective action upon input loop break. Relay ON and OFF delay times are user adjustable. Up to four front panel indicators show alarm and/or relay state. All relays can be configured for 0-100% deadband.

Relay Operation/Configuration

There are powerful relay functions that can be configured in the Helios meter, including:

- Automatic reset only (non-latching)
- Automatic + manual reset at any time (non-latching)
- Latching (manual reset only)
- Latching with clear (manual reset only after alarm condition has cleared)
- Pump alternation control (automatic reset only)
- Sampling (activated for a user-specified time)
- User selectable fail-safe operation
- Relay action for loss (break) of 4-20 mA input signal
- Time delay (on and off), independent for each relay
- Manual control mode
- Interlock relay mode

Analog Output

The isolated analog retransmission signal can be configured to represent process input channel A or B, math result (C), max or min for channel A, B, or highest or lowest max or min of A and B, set points, Modbus input, or manual control mode. While the output is nominally 4-20 mA, the signal will accurately accommodate under- and over-ranges from 1 to 23 mA.

Manual Output Control

Take control of any output with this feature. All relays can be forced ON or OFF, and the 4-20 mA output signal can be set to any value within its range. When the relays and 4-20 mA output are controlled manually, an LED labeled "M" is turned on and the associated Alarm LEDs (1-4) flash every 10 seconds indicating that the meter is in manual control mode.



Isolated Transmitter Power Supplies

A powerful 24 V @ 200 mA power supply is a standard feature on the Helios meter. It can be configured for 5, 10, or 24 V (default) by means of a simple internal jumper (see manual). An additional power supply (24 V @ 40 mA) is standard with the 4-20 mA output option.

Sampling Function (PV Triggered Timed Relay)

The sampling function allows the operator to set a set point for a "sampling" relay. The relay can be assigned to input channels A or B, or the math result (C). When the PV reaches that set point, it will close that relay's contacts for a preset period of time (0.1 to 5999.9 seconds). An example of its use may be for beer/ale fermentation. When the batch reaches a certain pH, the relay contacts would close and alert someone or automatically take a sample of the batch. This function can be used whenever a timed relay output closure is required when the PV reaches a certain set point.

Interlock Relay(s)

This function allows a process to use one or more very low voltage input signals or simple switch contacts to control the state of one or more internal "interlock" relays. A violation (i.e. loss of input, open switch, or open circuit) forces one or more N/O interlock relay contacts to open. One input can be used in series with a number of interlock switches, or up to four inputs can be required to force-on one (or more) internal interlock relays. Please see *Safety Interlock on the ProVu Series* whitepaper on our website for more information.

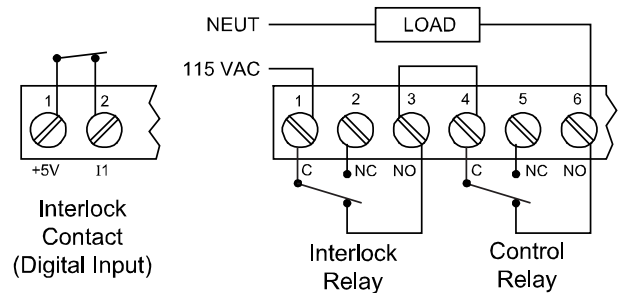

SIGNAL INPUT CONDITIONING

Non-linear input signals (i.e. weirs & flumes, differential pressure, etc.) can be linearized with the Helios's simple to use built-in signal input conditioning, such as: square-root extractor, exponential linearizer, horizontal round tank linearizer, or the Helios powerful general purpose 32-point linearizer.

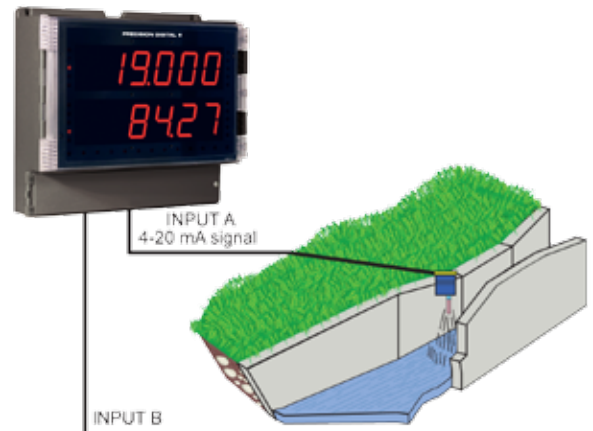

Weir Flow Calculated Using Exponential Signal Input Conditioning

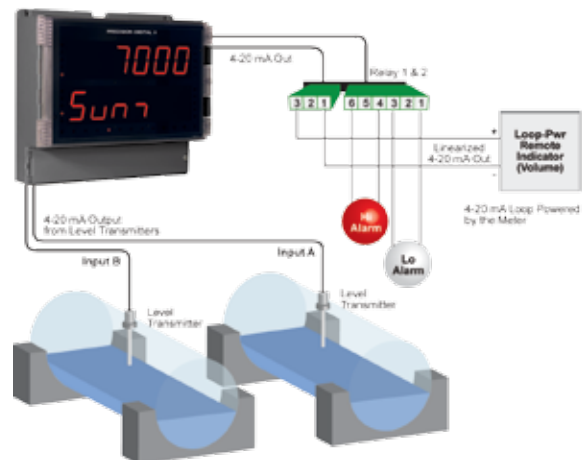

Round Horizontal Tank Signal Input Conditioning

PD2-6060 Helios Dual-Input Process Meter

Multi-Pump Alternation

For pump control applications where 2 or more similar pumps are used to control the level of a tank or a well, it is desirable to have the pumps operate alternately; this prevents excessive wear and overheating of one pump over the lack of use of the others. The Helios can accommodate up to 4 pumps. In the example below, a pair of relays have been set up to alternate every time an on/off pump cycle is completed. Another pair of relays is used for low and high alarms.

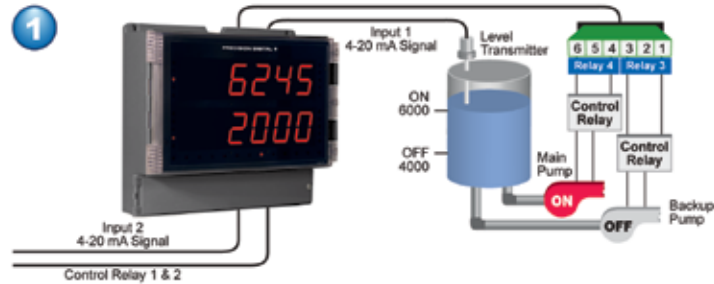

Relay #4 turns the main pump on at 6000 gallons and turns it off at 1000 gallons.

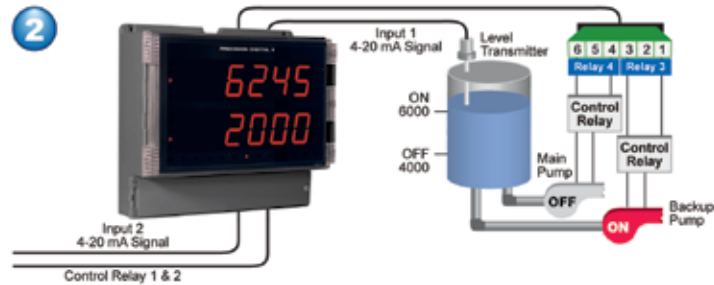

With the Pump Alternation feature activated, the next time the level reaches 6000 gallons, relay #3 transfers and starts the backup pump.

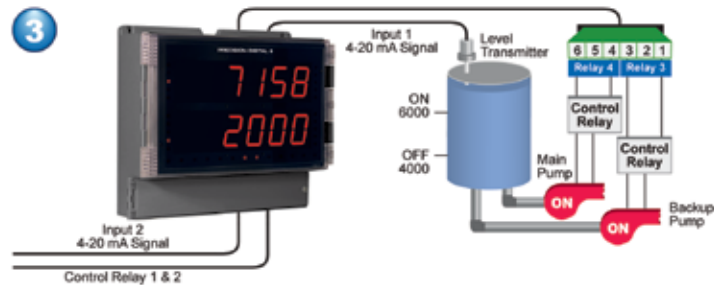

If the backup pump is not able to keep up, and the level reaches 7000 gallons, relay #4 transfers and starts the main pump as well.

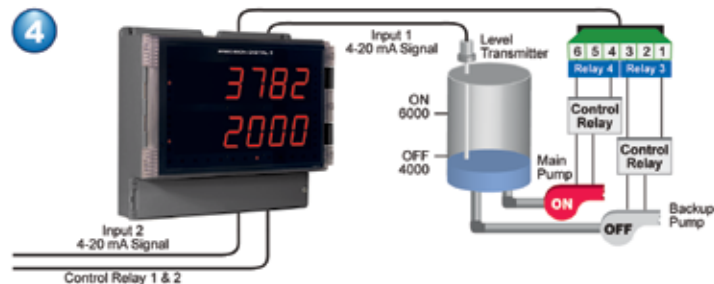

At 4000 gallons, relay 3 turns off and the system returns to normal pump alternation control.

SPECIFICATIONS

Except where noted all specifications apply to operation at +25°C.

General

Display: Two lines with 1.8" (46 mm) high digits, red LEDs; 6 digits per line (-99999 to 999999), with lead zero blanking

Display Intensity: Eight user selectable intensity levels

Display Update Rate: 5/second (200 ms)

Overrange: Display flashes 999999

Underrange: Display flashes -99999

Display Assignment: Display lines 1 & 2 may be assigned to process values for Channels A (Ch-A), B (Ch-B), or C (Ch-C), toggle between (Ch-A & Ch-B, Ch-A & Ch-C, Ch-B & Ch-C, and Ch-A, Ch-B, & Ch-C), toggle between Channel & units, show channel gross value (no tare) or toggle net (tare) and gross values, show relay set points, max & min values, or Modbus input. The lower display may also be set to show engineering units or be off, with no display.

Programming Methods: Four programming buttons, digital inputs, PC and MeterView Pro software, or Modbus registers.

Noise filter: Programmable from 2 to 199 (0 will disable filter)

Filter Bypass: Programmable from 0.1 to 99.9% of calibrated span

Recalibration: All ranges are calibrated at the factory. Recalibration is recommended at least every 12 months.

Max/Min Display: Max/min readings reached by the process are stored until reset by the user or until power to the meter is turned off.

Password: Three programmable passwords restrict modification of programmed settings.

Pass 1: Allows use of function keys and digital inputs

Pass 2: Allows use of function keys, digital inputs and editing set/reset points

Pass 3: Restricts all programming, function keys, and digital inputs.

Non-Volatile Memory: All programmed settings are stored in non-volatile memory for a minimum of ten years if power is lost.

Power Options: 85-265 VAC 50/60 Hz, 90-265 VDC, 20 W max or 12-24 VDC ± 10%, 15 W max. Powered over USB for configuration only.

Fuse: Required external fuse: UL Recognized, 5 A max, slow blow; up to 6 meters may share one 5 A fuse.

Isolated Transmitter Power Supply: Terminals P+ & P-: 24 VDC ± 10%. 12-24 VDC powered models selectable for 24, 10, or 5 VDC supply (internal P+/P- switch).

85-265 VAC models rated @ 200 mA max, 12-24 VDC powered models rated @ 100 mA max, @ 50 mA max for 5 or 10 VDC supply.

Normal Mode Rejection: Greater than 60 dB at 50/60 Hz

Isolation: 4 kV input/output-to-power line. 500 V input-to-output or output-to-P+ supply.

Overvoltage Category: Installation Overvoltage Category II: Local level with smaller transient overvoltages than Installation Overvoltage Category III.

Environmental: Operating temperature range: -40 to 150°F (-40 to 65°C); Storage temperature range: -40 to 185°F (-40 to 85°C); Relative humidity: 0 to 90% non-condensing

Connections: Removable and integrated screw terminal blocks accept 12 to 22 AWG wire.

Enclosure: UL Type 4X, IP65 rated. Polycarbonate & glass blended plastic case, color: gray. Includes four PG11 through-hole conduit openings, with two factory installed PG11, IP68, black nylon threaded hole plugs with backing nuts.

Wall Mounting: Four (4) mounting holes provided for mounting meter to wall.

Pipe Mounting: Optional pipe mounting kit (PDA6260) allows for pipe mounting. Sold separately. See manual for mounting instructions.

Tightening Torque: Screw terminal connectors: 5 lb-in (0.56 Nm); Digital I/O and RS485 Terminals: 2.2 lb-in (0.25 Nm)

Overall Dimensions: 10.63" x 12.59" x 4.77" (270 mm x 319.7 mm x 121.2 mm) (W x H x D)

Weight: 6.10 lbs (2.76 kg)

UL File Number: UL & C-UL Listed. E160849; 508 Industrial Control Equipment.

Warranty: 3 years parts & labor

USB Connection: Compatibility: USB 2.0 Standard, Compliant Connector Type: Micro-B receptacle

Cable: USB A Male to Micro-B Cable

Driver: Windows 98/SE, ME, 2000, Server 2003/2008, XP 32/64-Bit, Vista 32/64-Bit, Windows 7 32/64-Bit, Windows 10 32/64-Bit

Power: USB Port

PD2-6060 Helios Dual-Input Process Meter

Dual Process Input

Inputs: Two non-isolated inputs, each separately field selectable: 0-20, 4-20 mA, ± 10 V (0-5, 1-5, 0-10 V), Modbus PV (Slave)

Channels: Channel A, Channel B, Channel C (Math channel)

Programmable Constants: Constant P (Adder): -99999 to 999999, default: 0.000; Constant F (Factor): 0.00001 to 999999, default: 1.000

Math Functions: Addition, difference, absolute difference, average, multiplication, divide, max of A or B, min of A or B, draw, weighted average, ratio, and concentration.

Sequence of Operations for Input Programming:

1. Select Input for A and B
2. Set up the engineering units for A, B, and C
3. Set up decimal point for A, B, and C
4. Scale A & B
5. Set up the displays for A, B, or C
6. Select the transfer function for A & B (e.g. Linear)
7. Select Math function for Channel C
8. Program constants for Factor (F) and Adder (P).
9. Program cutoff values for A and B

Accuracy: $\pm 0.03\%$ of calibrated span ± 1 count, square root & programmable exponent accuracy range: 10-100% of calibrated span

Temperature Drift: 0.005% of calibrated span/ $^{\circ}$ C max from 0 to 65 $^{\circ}$ C ambient, 0.01% of calibrated span/ $^{\circ}$ C max from -40 to 0 $^{\circ}$ C ambient

Signal Input Conditioning: Linear, square root, programmable exponent, or round horizontal tank volume calculation.

Multi-Point Linearization: 2 to 32 points for channel A and B

Programmable Exponent: 1.0001 to 2.9999

Low-Flow Cutoff: 0-999999 (0 disables cutoff function)

Decimal Point: Up to five decimal places or none: d.ddddd, d.dddd, d.ddd, d.dd, d.d, or dddddd

Calibration Range:

Input Range	Minimum Span Input 1 & Input 2
4-20 mA	0.15 mA
± 10 V	0.01 V

An error message will appear if the input 1 and input 2 signals are too close together.

Input Impedance: Voltage ranges: greater than 500 k Ω . Current ranges: 50 - 100 Ω (depending on resettable fuse impedance).

Input Overload: Current input protected by resettable fuse, 30 VDC max. Fuse resets automatically after fault is removed.

F4 Digital Input Contacts: 3.3 VDC on contact. Connect normally open contacts across F4 to COM.

F4 Digital Input Logic Levels: Logic High: 3 to 5 VDC; Logic Low: 0 to 1.25 VDC

Relays

Rating: 2 or 4 SPDT (Form C) internal and/or 4 SPST (Form A) external; rated 3 A @ 30 VDC and 125/250 VAC resistive load; 1/14 HP (≈ 50 W) @ 125/250 VAC for inductive loads.

Noise Suppression: Noise suppression is recommended for each relay contact switching inductive loads.

Deadband: 0-100% of span, user programmable

High or Low Alarm: User may program any alarm for high or low trip point. Unused alarm LEDs and relays may be disabled (turned off).

Relay Operation: automatic (non-latching), latching (requires manual acknowledge), sampling (based on time), pump alternation control (2 to 8 relays), Off (disable unused relays and enable interlock feature, manual on/off control mode).

Relay Reset: User selectable via buttons behind front panel or digital inputs.

1. Automatic reset only (non-latching), when input passes the reset point.
2. Automatic + manual reset at any time (non-latching).
3. Manual reset only, at any time (latching).
4. Manual reset only after alarm condition has cleared (latching).

Note: Button behind front panel or digital input may be assigned to acknowledge relays programmed for manual reset.

Time Delay: 0 to 999.9 seconds, on & off relay time delays. Programmable and independent for each relay.

Fail-Safe Operation: Programmable and independent for each relay.

Note: Relay coil is energized in non-alarm condition. In case of power failure, relay will go to alarm state.

Auto Initialization: When power is applied to the meter, relays will reflect the state of the input to the meter.

Serial Communications

Protocol: Modbus[®] RTU

Meter Address/Slave ID: 1 - 247

Baud Rate: 300 - 19,200 bps

Transmit Time Delay: Programmable between 0 and 199 ms

Data: 8 bit (1 start bit, 1 or 2 stop bits)

Parity: Even, odd, or none with 1 or 2 stop bits

Byte-to-Byte Timeout: 0.01 - 2.54 seconds

Turn Around Delay: Less than 2 ms (fixed)

Note: Refer to the ProVu[®] Modbus Register Tables located at www.predig.com for details.

Isolated 4-20 mA Transmitter Output

Output Source: Process channel A, B, or C, max or min for channel A, B, or highest or lowest max or min of A and B, set points 1-4, Modbus input, or manual control mode

Scaling Range: 1.000 to 23.000 mA for any display range

Calibration: Factory calibrated: 4.000 to 20.000 = 4-20 mA output

Analogue Output Programming: 23.000 mA maximum for all parameters: Overrange, underrange, max, min, and break

Accuracy: $\pm 0.1\%$ of span ± 0.004 mA

Temperature Drift: 0.4 μ A/ $^{\circ}$ C max from 0 to 65 $^{\circ}$ C ambient, 0.8 μ A/ $^{\circ}$ C max from -40 to 0 $^{\circ}$ C ambient

Note: Analogue output drift is separate from input drift.

Isolated Transmitter Power Supply: Terminals I+ & R: 24 VDC $\pm 10\%$. Isolated from the input at >500 V. May be used to power the 4-20 mA output or other devices. All models rated @ 40 mA max.

External Loop Power Supply: 35 VDC maximum

Output Loop Resistance:

Power Supply	Minimum	Maximum
24 VDC	10 Ω	700 Ω
35 VDC (external)	100 Ω	1200 Ω

Digital Input & Output Terminal

Channels: 4 digital inputs & 4 digital outputs

Digital Input Logic High: 3 to 5 VDC

Digital Input Logic Low: 0 to 1.25 VDC

Digital Output Logic High: 3.1 to 3.3 VDC

Digital Output Logic Low: 0 to 0.4 VDC

Source Current: 10 mA maximum output current

Sink Current: 1.5 mA minimum input current

+5 V Terminal: To be used as pull-up for digital inputs only. Connect normally open pushbuttons across +5 V & DI 1-4.



PD2-6060 Helios Dual-Input Process Meter

CONNECTIONS

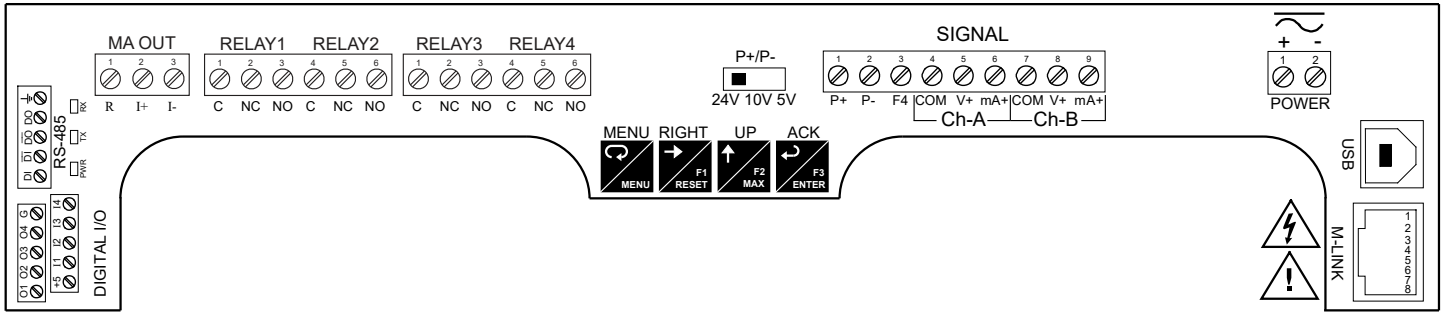

Connector Labeling for Fully Loaded PD2-6060

DIMENSIONS

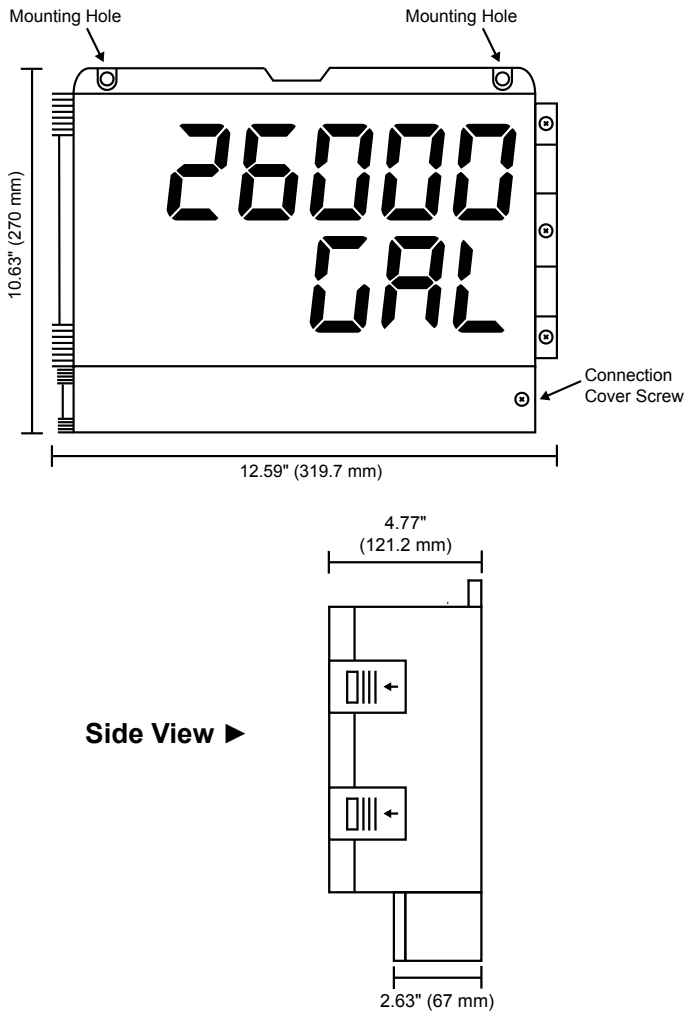

ORDERING INFORMATION

PD2-6060 • Standard Models		
85-265 VAC Model	12-24 VDC Model	Options Installed
PD2-6060-6H0	PD2-6060-7H0	No Options
PD2-6060-6H7	PD2-6060-7H7	4 Relays & 4-20 mA Output

Note: 24 V Transmitter power supply standard on all models.

Accessories	
Model	Description
PDA6260	Pipe Mounting Kit
PDA7485-I	RS-232 to RS-422/485 Isolated Converter
PDA7485-N	RS-232 to RS-422/485 Non-Isolated Converter
PDA8485-I	USB to RS-422/485 Isolated Converter
PDA8485-N	USB to RS-422/485 Non-Isolated Converter
PDAPLUG2	Plastic Conduit Plug
PDX6901	Suppressor (snubber): 0.01 μ F/470 Ω , 250 VAC

Your Local Distributor is:

Disclaimer

The information contained in this document is subject to change without notice. Precision Digital Corporation makes no representations or warranties with respect to the contents hereof, and specifically disclaims any implied warranties of merchantability or fitness for a particular purpose. ©2016-2018 Precision Digital Corporation. All rights reserved.

LDS2-6060_C 08/18