



bürkert
FLUID CONTROL SYSTEMS



bürkert
FLUID CONTROL SYSTEMS

Product Overview Measurement Devices

Bürkert Fluid Control Systems
Christian-Bürkert-Straße 13-17
74653 Ingelfingen
Germany
Tel. +49 7940 100
Fax +49 7940 1091204
info@burkert.com
www.burkert.com



01 SOLENOID VALVES

02 PROCESS VALVES

03 PNEUMATICS

04

05 MICROFLUIDICS

06 MASS FLOW CONTROLLERS

07 PROPORTIONAL VALVES

Content

3	Introduction
4	Fascination Bürkert
6	Bürkert Provides Process Solutions
8	Overview Measurement Solutions
10	Overview Digital Communication
14	Electronics
16	Online Analysis System Type 8905
18	multiCELL Type 8619
20	eControl Type 8611
22	Process Controller Types 8693/8793
26	Flow
68	Level
78	Pressure
84	Temperature
88	pH/ORP
100	Conductivity
114	Disinfectants/Oxidants
120	Iron
122	SAC
124	Turbidity
126	Online Analysis Sensor Cubes – Overview
128	Accessories
130	Typical sensor loop applications
134	Systemhaus solutions
136	Bürkert worldwide

The Complete Control Loop Market Leader

Across thousands of individual solutions and spanning dynamic conditions of global competition our mission is to work towards your success.

We have decades of global experience and we have always been positioned at the forefront of sensor technology.

Our innovative approach to your success is to secure your process efficiency, lower your downtime, increase your safety and boost your competitive advantage.

We intend to collaborate with you where we can share our control loop experience.

All of our combined knowledge is available to you through consultation, engineering support, selection and commissioning.

Everyone in our organization is interested in listening to you with the aim of presenting you only the most appropriate solution fluently in your daily application language.

Welcome to the Fascinating World of Fluid Control Systems

Measurement and control: When it comes to working with liquids and gases, we are at your side – as a manufacturer of sophisticated products, as a problem-solver with an eye for the big picture, and as a partner offering you reliable advice. Since we started in 1946, we have developed into one of the world's leading suppliers of Fluid Control Systems. At the same time we have kept our status as a family-owned business with a foundation of strong basic values to highlight the way we think and act.

EXPERIENCE

There are things which are not inherently yours. You have to gather them bit by bit. You receive them from others. And you constantly have to acquire them anew. That is what makes them so valuable. Experience is one of those things. For instance, because of our many years of experience with metering, controlling and analysing of fluids, we can provide our extensive services to you – from consulting, development, and 3D CAD simulating to testing and after-sales service. Whether individual product solutions or a pioneering new system for the entire control process: Benefit from our experience!

COURAGE

Those who only work toward optimizing things that already exist will eventually reach the limits – technically, financially, or personally. In order to overcome these limits, courage is needed: The courage to be different and trust one's own ideas; the courage to venture into the unknown, searching for new ways to develop products that have never existed before. We have this courage. By pooling and utilizing our competencies across all sectors, you benefit from our cumulative knowledge in metering of fluids – whether it is in water treatment, cooling or hygienic processing applications.

CLOSENESS

There are things we simply take for granted. Only when they are gone, do we realize how important these things really were. This applies in particular to closeness. Without closeness, it is very difficult to build relationships and a good understanding of one another. As an established medium-sized company, we know that. And that is why we are always there for you. Working with you, we develop the best possible solutions for your projects. Our global presence in 35 locations enables us to press ahead with sensor innovations for our customers around the world.

Bürkert Product Program

We are one of the few suppliers on the market to cover the complete control loop. Our current product range extends from solenoid valves through process and analytical valves to pneumatic actuators and sensors.

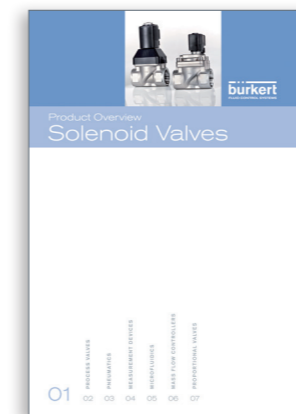

Bürkert offers a remarkable range of servo-assisted and direct acting solenoid valves. Read more about them in this brochure.

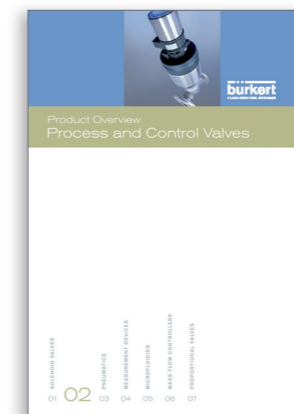

Bürkert offers unlimited modularity for process control with angle-seat, globe and diaphragm valves in the widest range of configurations.



Here you can find our product range of pneumatic valves, valve units and automation systems as well as information on our control cabinet building.



Here you can find our sensors, transmitters and controllers for measuring and controlling flow, temperature, pressure, level, pH/ORP and conductivity.

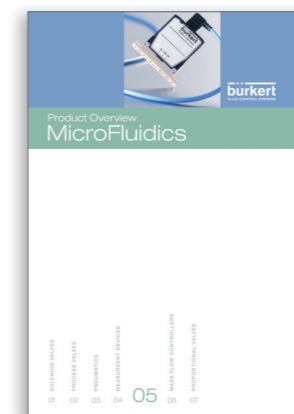

The brochure contains an overview of Bürkert miniature valves and micro pumps, which allow for precise and safe handling of small volumes of liquids.

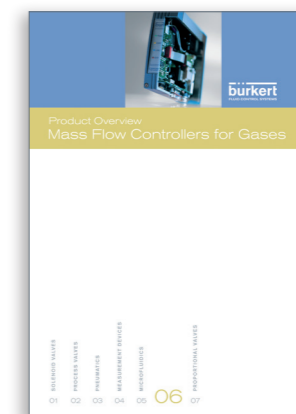

This brochure provides technical background information as well as a detailed product overview for the mass flow controller and meter product range.

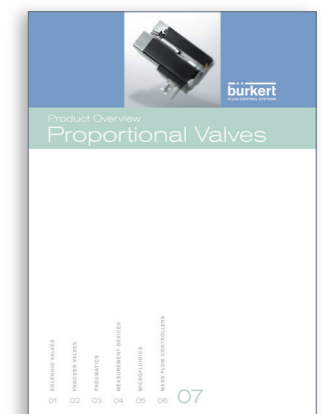

This brochure presents our solenoid control valves including their respective features, functions and typical applications.



Providing Process Vision

For more than 20 years we have been providing our customers with sensors, transmitters and controllers where fit-for-purpose is optimized. At the same time our sensor range has become a key ingredient of our offer to complete the control loop and take care of your process headaches.

From the outset our clients, large and small, have appreciated the practical orientation, man-machine interface and architecture of the sensor range characterized by extremely simple installation, commissioning, calibration and teach functionality. Standardized layout, electrical interfaces, process connections and, above all, intuitive menus, make the whole range simple to work with.

Designed to Fit Our Clients Applications – Perfectly

When we define quality as fit-for-purpose, Bürkert sensors prove their exceptional quality in all relevant applications. Wherever you need to display process values, perform control functions, monitor alarms to control flow rates, monitor leaks or control pH values Bürkert sensors make the difference.

EDIP – Efficient device integration platform

After mechanical production systems were established worldwide, begins now the new industrial era “Industry 4.0” in which industrial processes are to be implemented digitally in every respect. Bürkert supports this development with the Efficient Device Integration Platform (EDIP), which enables intelligent networking down to the sensor and actuator level.

The platform not only makes it significantly easier for users to operate the field devices but also simplifies integration into existing systems which are based on various fieldbus standards or Industrial Ethernet. The modular design of the platform allows the adaptation of devices according to individual customer requirements and enables shorter delivery times. The customer also benefits from a standardized device interface that provides a convenient operation and display concept, faster and easier start-up and an uncomplicated transfer and backup of device settings.

1. User interface

– Intuitive and modular user interface (HMI, menus, device drivers, etc.) standardize the operation of all EDIP devices.

2. CANopen – Communication standard

– Communication between the EDIP devices takes place via an interface based on the industry standard CANopen. This digital interface is nothing other than CANopen with additional features.

3. Integrated adaptability

– The integration of EDIP modules in plants based on industry standards, such as PROFINET, EtherNet/IP, Modbus TCP, PROFIBUS etc. is made possible by a modular concept.

4. Communicator – the universal tool

– ‘Bürkert Communicator’ is the software for the parametrization, configuration and service of field devices. It also features monitoring and diagnostic capabilities.

5. Decentralized intelligence in the field

– With the help of the graphical programming integrated in the Communicator it is possible to implement decentralized control of sub-systems. Various control functions can be created using the function blocks from the tool’s library.





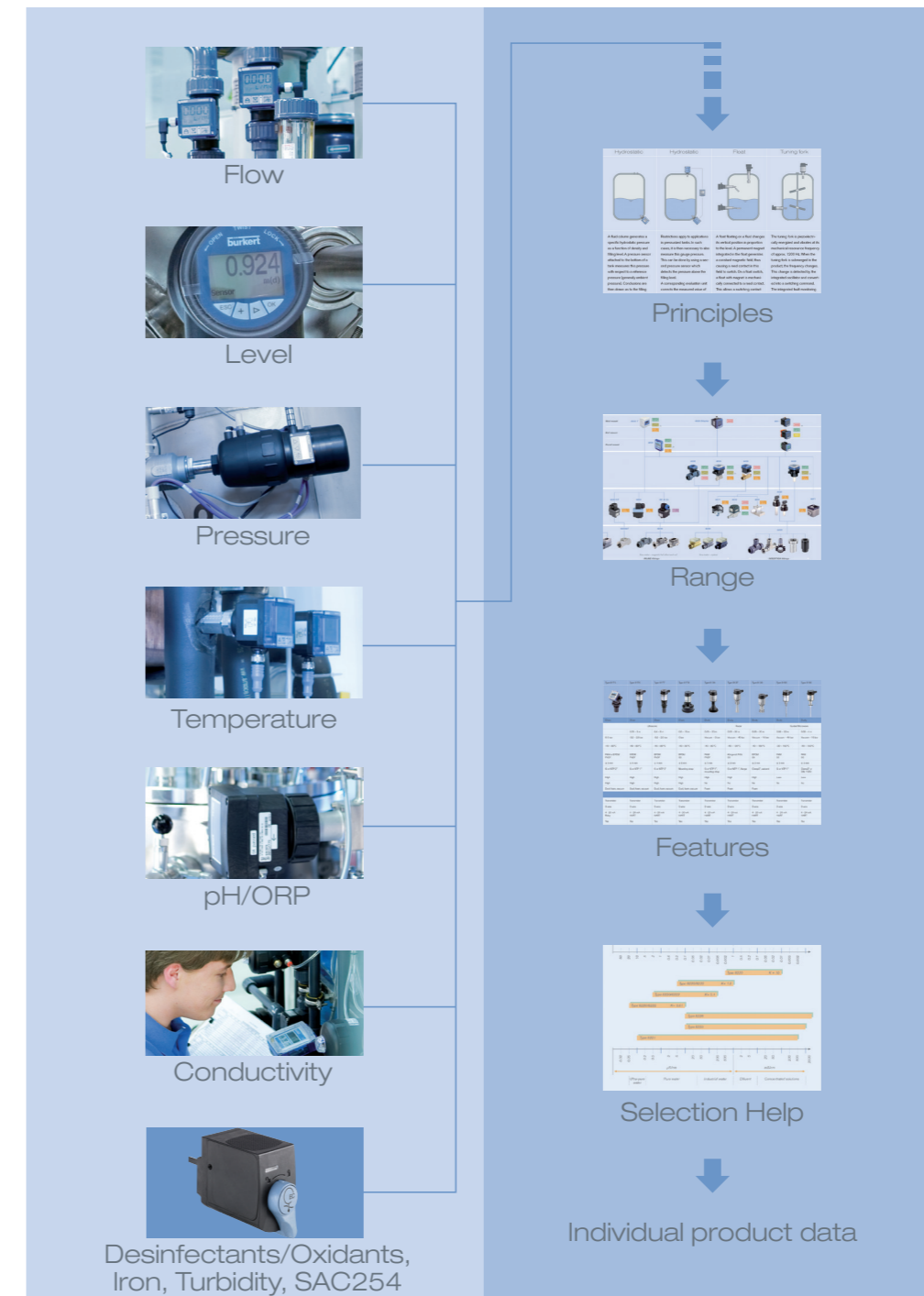



How to Use this Brochure

Each measured process variable has information to help you choose the correct equipment for your purpose. In this brochure you will find technical principles, range overviews, features and selection help. Datasheets for each type are always available online at www.burkert.com. Subject to change, the current specifications can be found in the respective data sheets!

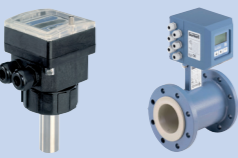

Disclaimer: Subject to change; for more information please see the corresponding datasheets

A Complete World of Measurement Solutions

Electronics	Flow	Level	Pressure	Temperature	pH/ORP	Conductivity	Desinfectants Oxidants	Iron	Turbidity
 <p>Online Analysis System Type 8905</p>	 <p>Paddle wheel</p>	 <p>Ultrasonic</p>	 <p>Transmitter / Switch / Display</p>	 <p>PT100 sensor</p>	 <p>Glass electrode</p>	 <p>Conductive</p>	 <p>Chlorine</p>	 <p>Flow injection analysis</p>	 <p>Scattered light</p>
 <p>multiCELL Type 8619</p>	 <p>Oval gear</p>	 <p>Radar</p>	 <p>Transmitter</p>	 <p>Transmitter / Switch / Display</p>	 <p>Enamel electrode</p>	 <p>Inductive</p>	 <p>Chlorine dioxide</p>		
 <p>eControl Type 8611</p>	 <p>Magmeter Magmeter insertion inline (full bore)</p>	 <p>Guided microwave</p>			 <p>ISFET MEMS</p>				
 <p>Process controller Type 8693/8793</p>	 <p>Ultrasonic</p>	 <p>Tuning fork</p>							
	 <p>Differential pressure</p>	 <p>Float switch</p>							
	 <p>Surface Acoustic Wave (SAW)</p>								
Page 14	Page 28	Page 66	Page 76	Page 82	Page 88	Page 100	Page 114	Page 120	Page 126

Overview Digital Communication

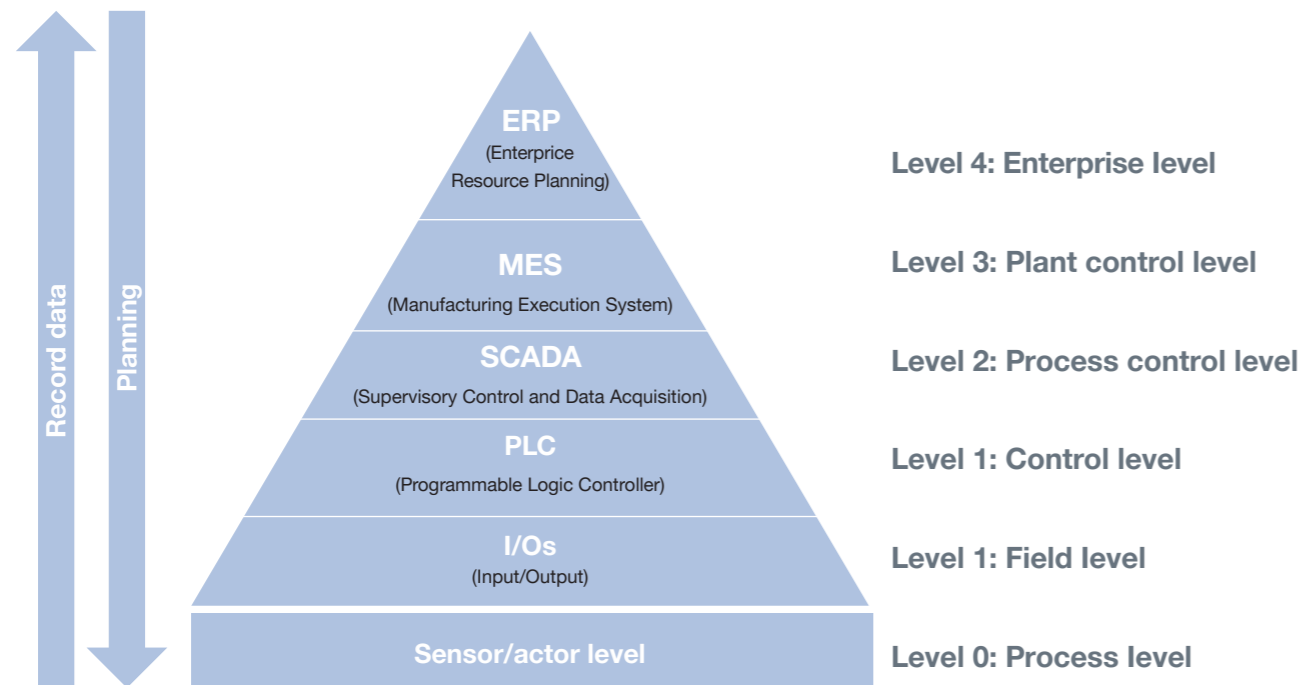

Bürkert supports this new industrial era where most processes are implemented digitally in every respect by following the trend of intelligent networking of devices down to the sensor and actuator level. We are members of the following organisations: CiA (CAN in Automation), PNO (PROFIBUS Nutzer Organisation), IO-Link Consortium and subscription holder at ODVA.

Bürkert offers support for Ethernet, CAN, RS-485 or 3-wire sensor technology based digital communication.

Supported protocols are shortly described within this chapter. For detailed information please see the official websites of the respective organisations.

Industrial Ethernet Protocols



is the innovative open standard for Industrial Ethernet, developed by Siemens and the Profibus User Organization (PNO). With PROFINET, solutions can be implemented for factory and process automation, for safety applications and for the entire range of drive technology right up to clock-synchronized motion control. PROFINET is standardized in IEC 61158 and IEC 61784. PROFINET products are certified by the PNO user organization, guaranteeing worldwide compatibility.

PROFINET is based on Ethernet and uses TCP/IP and IT standards and complements them with specific protocols and mechanisms to archive a good real time performance. PROFINET enables the integration of existing fieldbus systems like PROFIBUS, DeviceNet etc. without changes to existing devices. That means that the investments of plant operators, machine and system builders, and device manufacturers are protected. PROFINET supports the setting up of a redundant topology in the form of a ring for communication with the help of MRP (Media Redundancy Protocol).

For detailed information please see PI Organisation (www.profibus.com).

EtherNet/IP™

is an open network which supports the widespread TCP/IP protocol. EtherNet/IP is managed by the Open DeviceNet Vendors Association (ODVA) and is based on the IEEE 802.3 standard. It is an already well established Industrial Ethernet communication system with good real-time capabilities. Devices based on this international standard are certified by ODVA for interoperability and conformance.

EtherNet/IP extends commercial off-the-shelf Ethernet to the Common Industrial Protocol (CIP) — the same upper-layer protocol and object model found in DeviceNet and ControlNet. It offers various topology options including a conventional star with standard Ethernet infrastructure devices, or device level ring (DLR) with EtherNet/IP. EtherNet/IP adapts key elements of Ethernet's standard capabilities and services to the CIP object model framework, such as the User Datagram Protocol (UDP), which EtherNet/IP uses to transport I/O messages. EtherNet/IP promotes transparency from sensors to the enterprise software.

For detailed organisation please see ODVA (www.odva.org).

Modbus TCP

Modbus was originally developed by Modicon and today it is managed by the Modbus Organization. Modbus is an open Master/Slave application protocol that can be used on several different physical layers. Modbus is an application-layer messaging protocol, positioned at level 7 of the OSI model. The simply structured data model is based on client/server architecture and transfers data inside TCP/IP packets. Modbus is thus fully compatible with standard Ethernet networks.

It provides client/server communication between devices connected on different types of buses or networks. Modbus-TCP is an open Industrial Ethernet based protocol which is basically TCP/IP protocol implemented over the Modbus protocol. Modbus devices are certified by the Modbus Organization for interoperability and conformance to the Modbus specification.

The well-proven Modbus services and the object model which has been available since the original Modbus protocol version are unchanged, and have simply been adapted to TCP/IP as the data transmission protocol. Different versions of Modbus such as Modbus-RTU, Modbus-Plus and Modbus-TCP share the same application protocol, which specifies a universal object module for user data and communication

For detailed information please see the Modbus Organisation (www.modbus.org).

Fieldbus Protocols



(PROcess Field BUS) is a universal, open, digital communication system. It opens up diverse applications from factory automation through to process automation. PROFIBUS is suitable for fast, time-critical and complex communication tasks.

PROFIBUS was originally defined under the German standard DIN 19245 and is today part of the international standard series IEC 61158. Based on the initial functionality, many new features have been added and today, PROFIBUS consists of a family of 3 protocol variations (DP, DPV1, DPV2) that can be used with different physical transmission media.

For detailed information please see PI Organisation (www.profibus.com).



is an open and flexible higher layer protocol that is used in an ever-increasing range of applications. It combines low cost with high performance and represents an attractive distributed control solution for many industrial applications.

The CANopen communication protocol is based on CAN (Controller Area Network). It comprises higher-layer protocols and profile specifications. It has been developed as a standardized embedded network with highly flexible configuration capabilities. CANopen networks provide point-to-point connections for service data objects (SDO, e.g. parameters and diagnostics) and multicast connections for process data objects (PDO).

Bürkert System Bus (büS): The new Bürkert products based on the digital platform EDIP use CANopen as the basis for communication with some additional features. However, all of them are also 100% compatible with standard CANopen.

For detailed information please see CiA Organisation (www.CAN-CIA.org).

Point to Point Communication



IO-Link is a standardized IO technology worldwide (IEC 61131-9) for the communication with sensors as well as actuators. The powerful point-to-point communication is based on the long established 3-wire sensor and actuator connection without additional requirements regarding the cable material. IO-Link is not a fieldbus but the further development of the existing, tried-and-tested connection technology for sensors and actuators.

For detailed information please see www.io-link.com/en/.

A Large Range of Sensors Need an Optimum Offering of Transmitters and Controllers

Our electronics are the gate to the process and realize the connection to the control level. The transmitters read, digitalise, interpret and amplify all kind of our sensors analogue or digital signals into electronic information, available to operators in the field as well as to the automation system. Our controllers are the heart of reliable loops whether they are positioned at the sensor, in a panel, on a wall or integrated onto a control valve. It is that flexible and that simple.

With multiple channels, relay outputs and digital communication using RS485, CAN and Ethernet as standard we offer solutions for all your process variables. Data logging, process tune, digital calibration, SD card interfaces and specific user friendly programming for cooling towers, boilers and reverse osmosis facilities means we can control pumps or valves, in real time, in any application.

Each device fits inside an architecture arranged around common interfaces and communication structures which are characterized by similar menus, displays, materials and connections. You can decide when to centralize or decentralize intelligence. The interface with our valves is designed to be as simple as possible. Even complete PID loops can be made with just two components.

Simplicity and flexibility from one source.



Online Analysis System Type 8905

One System – All Important Water Parameters

Online Analysis System stands for a modular system which combines electronic units of the EDIP platform from Bürkert with Sensor Cubes to measure the quality of water. On the electronic side the range of modules consists of:

- 7" Touch screen and the related HMIU (1)
- I/O modules for analogue or digital inputs and outputs
- Bus connection modules
- Examples: EtherNet/IP, PROFINET, Modbus TCP, PROFIBUS DP

1. The Human Machine Interface Unit (HMIU) includes the functionality to connect the 7" Touch display

- Data logger for the measurements as well as for messages or event notes
- USB Port for logged data download and software upload
- Ethernet connector for network access to data and for remote operations
- Software to operate f(x) functions (2)

2. f(x) functions are integral content of the product platform of Bürkert. It's the name for user defined or predefined (to be loaded from web or any data storage) functions to do calculations of values from any data sources within a network of Bürkert EDIP components. The Bürkert Communicator is the tool to provide the full range of functions which is possible with the platform techniques. Please refer to the specific literature on the web or the related brochures.

Type 8905 is the more economical solution

- No wiring and piping on site needed when installing the integrated system
- Just ONE training to handle ONE kind of menu operations on ONE display
- ONE contact for maintenance and service issues
- Low electrical power consumption – low sample water demand and so not only economical but also ecological duty

Type 8905 is the more future proof solution

- The system is prepared for the next generation of communication and data handling
- New Sensor Cubes can be retro fitted by just being plugged into a spare backplane within the system
- New Sensor Cubes are in the development loop and a lot more parameters will be available in future



Usually there are a lot of different measurement systems packed together on a mounting wall – most often with several displays which are to be operated differently. All the most important water parameters can be measured with the Online Analysis System Type 8905 on one unit.

If there are more than six different parameters to be measured there could be one specific analyser cabinet. These cabinets are customer or application specific system designed. The analyser cabinet shows Systemhouse Solution form a small town's water treatment plant with seven different sample waters.

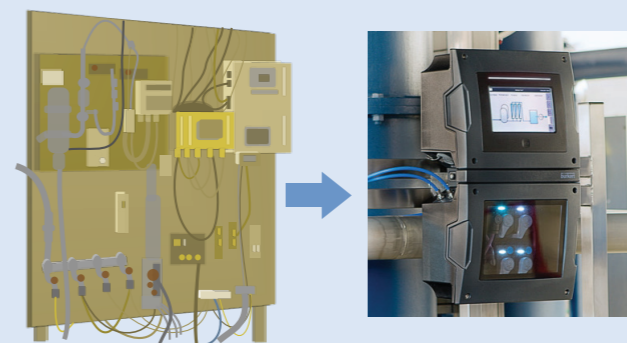
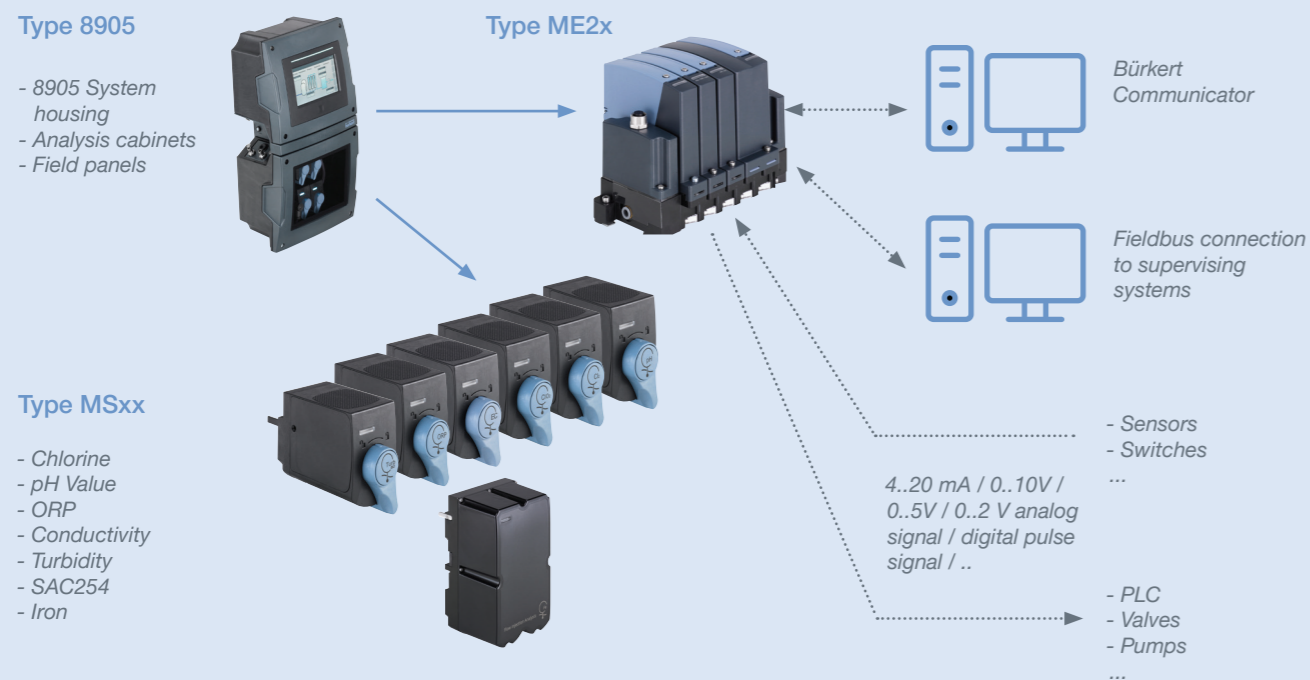

A huge and growing wall with numerous different sensors

Combined into one platform with all important parameters



multiCELL Type 8619 – Maximum Flexibility and Productivity

multiCELL Type 8619 is a remote multichannel transmitter / controller with extended input and output capabilities. Thanks to the modular software and hardware concept, it can be easily adjusted to satisfy individually the needs of nearly every application. The easy adjustment to an analytical transmitter, flow transmitter, PID-controller (and many other possibilities) underlines its outstanding flexibility. In addition if needed all functionalities can be combined freely.

Industrial environments with demanding conditions are the homeland of multiCELL Type 8619. Besides the wide ambient temperature range and the glass- and metal-free design, the remote transmitting unit Type 8619 ensures unaffected functionality even at corrosive atmospheres or during demanding cleaning processes and in addition there's no risk of any glass breakage. A big robust monochromatic display with big push-buttons underline the good readability and easy operating in harsh and dusty areas even equipped with heavy gloves. If no control cabinet is available, the wall-mount housing can be easily mounted on walls, pipes or stanchions.

Thanks its advanced Ethernet skills a system-integration into industrial real-time networks is easily possible. Due to the integrated two-port Ethernet switch daisy-chain-topologies can be realized for saving wiring-effort and invest in expensive industrial switches. In addition to increase drastically the system availability, closed ring topologies are supported.¹⁾ Process diagnostics, measurement values, feedback signals can be as easily transferred as set-points and commands for the controlling functionalities such as PID or Dosing.

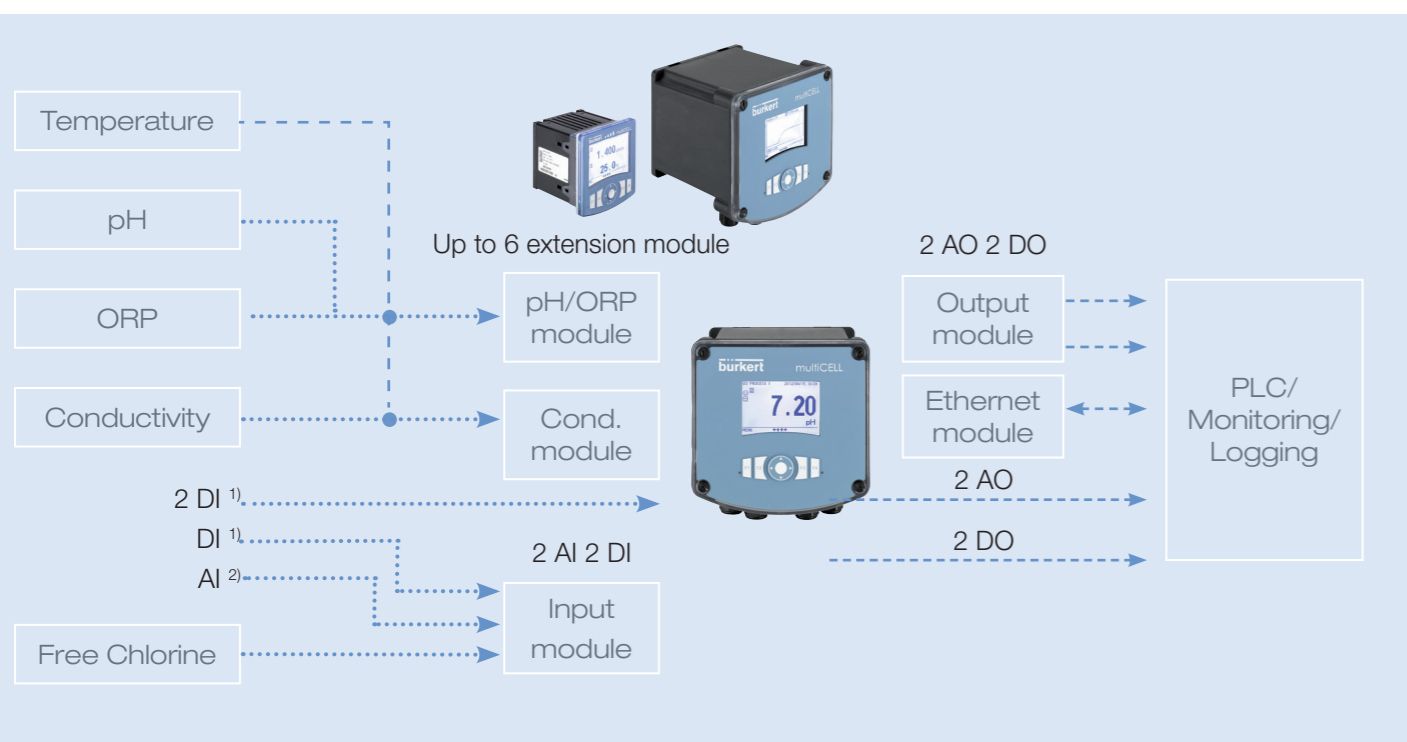

AI: Analogue Input; DI: Digital Input; AO: Digital output; DO: Digital Output

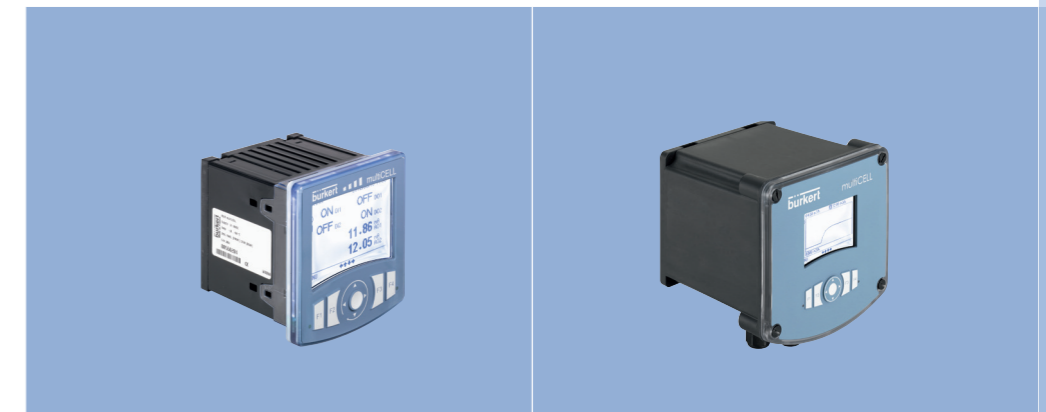

Type		8619 Panel	8619 Wallmount
Mounting size		¼ DIN Cut out	181 x 186 x 172 mm
Mounting type		Panel, control cabinet	Wall; pipe
Ambient conditions		Max 70°C (reduced to 60°C with extension modules); Cover IP65/67; Case: IP20	Max 75°C (reduced to 60°C with extension modules); IP 65/67
Display		160x128 pixels 4" monochrome, backlight	160 x 128 pixels 4" monochrome, backlight
Controller type		PID	PID
Power supply		12...36 VDC	12...36 VDC; 110...240 VAC
Controller channels		max. 6 channels	max. 6 channels
Inputs	Analogue	2 (0/4-20 mA or 0-2V / 0-5V / 0-10V), extendable	2 (0/4-20 mA or 0-2V / 0-5V / 0-10V), extendable
	Digital (Static, frequency)	2 (also suitable for flow sensor input), extendable	2 (also suitable for flow sensor input), extendable
	Raw signal	Options: Conductivity pH/ORP, Pt100 /Pt1000	Options: Conductivity pH/ORP, Pt100 /Pt1000
Output	Analogue	Standard: 2 (4-20 mA), extendable	Standard: 2 (4-20 mA), extendable
	Digital	Standard: 2 transistors, extendable	Standard: 2 transistors, extendable
Communication interface		Industrial Ethernet two-port switch with support for daisy chain and closed ring topology (option ¹⁾)	Industrial Ethernet two-port switch with support for daisy chain and closed ring topology (option ¹⁾)
Supported protocols		EtherNet/IP, Modbus TCP, PROFINET ²⁾	EtherNet/IP, Modbus TCP, PROFINET ²⁾
Remarks		SD-Card slot for data logging & configuration. Software extensions for flow measurement, for dosing and mathematical functions, PID-control and / or concentration tables (specific measurement ranges for sulfuric acid, nitric acid, hydrochloric acid, sodium hydroxide or NaCl-Solution)	SD-Card slot for data logging & configuration. Software extensions for flow measurement, for dosing and mathematical functions, PID-control and / or concentration tables (specific measurement ranges for sulfuric acid, nitric acid, hydrochloric acid, sodium hydroxide or NaCl-Solution)

1) Depends on used Ethernet protocol and other system components

2) Support of conformance classes A and B

eCONTROL Type 8611 – Single Channel Universal Controller

The universal controller 8611 is especially designed for compact control system applications. It is compatible and tested with a wide range of proportional valves and sensors and can be connected to every Bürkert control valve via standard signals like 4...20 mA, 0...10 V or PWM-output. The proportional & integral (PI) process controller is equipped with many additional functions. The actual process value can be supplied as feedback as one of the three inputs: a standard signal (4...20 mA / 0...10 V), frequency or RTD signal, directly to the universal controller. The process switching points can be set via a 4...20 mA or 0...10 V signal or with the keypad. For temperature specific control, it is possible to set a cascade structure with both temperature and flow as inputs. Thanks to the proportional control capabilities, a wide range of control functions can be performed in a variety of liquids and gas media.



Type	8611	
Mounting size	54x54x50mm1/16 DIN Cut out	
Mounting type	Wall/rail/panel and valve	
Display	8-digit, 2-line with backlight	
Controller type	PI, 2-P control, cascade	
Power supply	24 VDC +/- 10%	
Controller channels	1 channel (2 for ratio control)	
Inputs	Analogue	4 (4-20mA, RTD)
	Digital	1
	Frequency	2 (Flow)
Output	Analogue	1 (4-20mA)
	Digital	3 transistor (NPN or PNP)
	Relay	
Communication interface	RS485 on request, IO-Link	
Remarks	Predefined loops for pressure, temperature, flow. Data for sensor and solenoid control valves are memorized. Ratio control function on request.	

Digital Electropneumatic Process Controller Types 8693 / 8793

The digital electropneumatic process controller Type 8693 is optimized for integrated mounting on ELEMENT Type 23xx/2103 pneumatic process valves and is uniquely designed to meet the requirements of any hygienic process environment.

The process controller is equipped with a unique feature "Process TUNE function" which automatically recognizes the control loop type and selects the right controller design with optimized parameters. This makes installation even for sophisticated processes very easy and safe by eliminating human errors. The actual value of the process variable is directly supplied to the controller by a suitable sensor as 4-20 mA, PT100 or a frequency signal. Depending on the magnitude of control deviation, the process controller computes the position set-point for the position control loop. The process variable is then changed by opening or closing the valve.

The easy handling and the selection of additional software functions are done either on a backlit graphical display with keypad or via PC interface with Bürkert-COMMUNICATOR software tool.

Thanks to diagnostic functions the process controller can monitor the actual process value including the operation conditions of the control valve round the clock. Therefore, improving the reliability of the entire plant while malfunction and unplanned plant shutdowns are avoided.



Control valve system ELEMENT
with process controller TopControl
Type 8693



Rotary control valve
with process controller SideControl
Type 8793

Digital electropneumatic process controller Type 8793 SideControl

Type 8793 process controller uses the same electronic platform and the same user-friendly operating concept as Type 8693 TopControl. It is designed for attachment to common linear and rotary actuators with standardization acc. to NAMUR/ IEC or remote for use in different applications. The remote version is extremely flexible in installation and can be combined with Bürkert ELEMENT control valves.

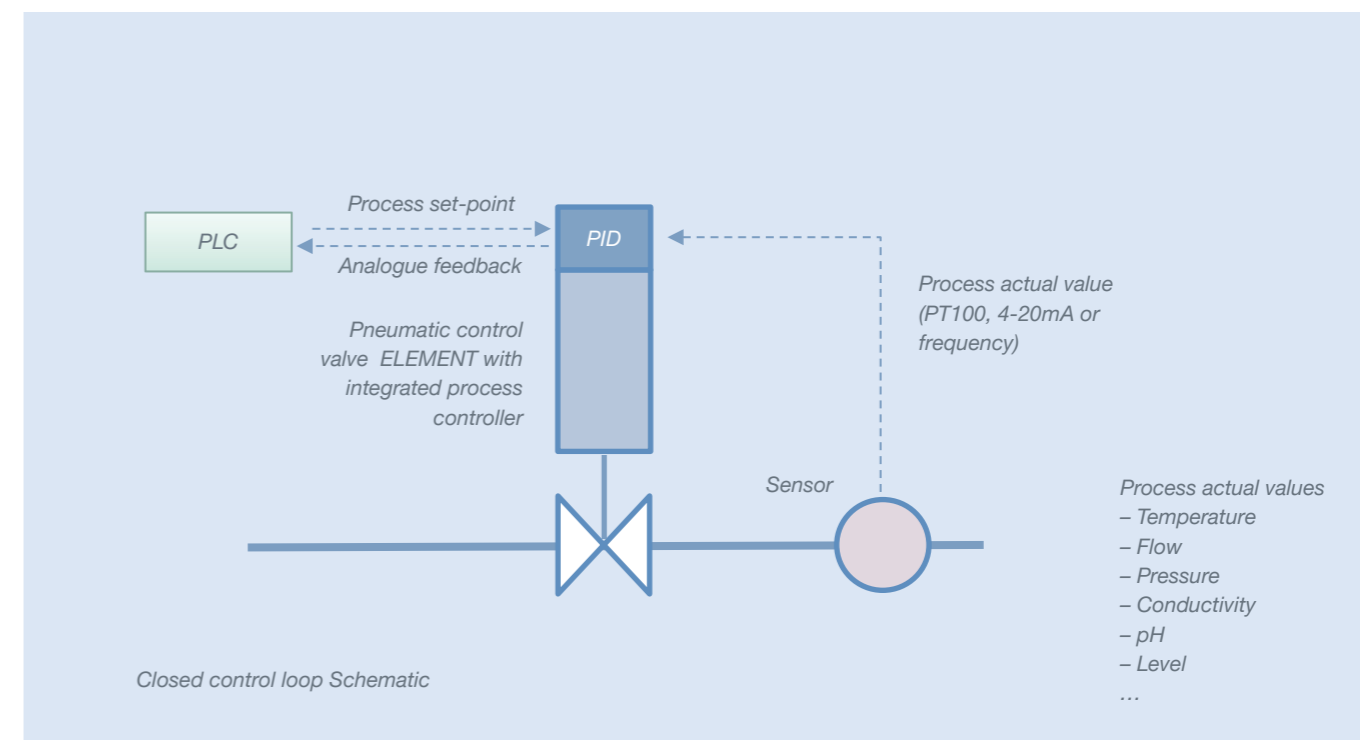

Process Controller Types 8693 / 8793



Type	8693 TopControl	8793 SideControl
Special features	<ul style="list-style-type: none"> – Compact and robust hygienic design suitable for wash-down applications – Direct top coupling with integrated control air routing and recycling for long valve lifecycle – Large backlit graphical display for easy operation – Easy and quick start-up via process TUNE function – Smart positioning system with no air consumption in steady state – Wear-free analogue position sensor – Integrated valve diagnostic functions supporting predictive maintenance and service 	<ul style="list-style-type: none"> – Compact and robust design – Large backlit graphical display for easy operation – Flexible mounting to common linear and rotary actuators – Remote mounting capability for high installation flexibility – Easy and quick start-up via process TUNE function – Smart positioning system with no air consumption in steady state – Integrated valve diagnostic functions supporting predictive maintenance and service
Mounting type	Integrated top mounting with ELEMENT process control valve	NAMUR / IEC 60534-6-1, VDI/VDE 3835 (60534-6-2) or remote
Process actual value	4 – 20 mA, Pt100 (measuring range – 20 to 220 °C), frequency signal	4 – 20mA, Pt100 (measuring range – 20 to 220°C), frequency signal
Set-point	0 / 4 – 20 mA, 0 – 5/10V	0 / 4 – 2 0mA, 0 – 5/10 V
Position sensor	Inductive contactless	Potentiometer, inductive (remote)
Power supply	24V DC, UL: NEC Class 2	24V DC
Output signals	Two binary, analogue (0 / 4 – 20mA, 0 – 5/10V)	Two binary, analogue (0 / 4 – 20 mA)
Communication interface	DeviceNet, Profibus DPV1	DeviceNet, Profibus DPV1
Ambient temperature	-10 to +55 °C	0 to +60 °C
IP Rating	IP65/ IP67, Type 4X acc. to NEMA 250 standard	IP65/ IP67, Type 4X acc. to NEMA 250 standard

Accurate and Reliable Flow Measurement Enhanced by Batch and Ratio Control

Flow monitoring and control is the foundation for the Bürkert sensor range.

In our factories we manufacture sensors and transmitters for a wide variety of customers around the world.

Liquid flow measurement is made by a wide range of principles which are explained in more detail on the next few pages but are composed of SAW (Surface Acoustic Wave), magmeter, ultrasonic, oval gear paddle wheel and differential pressure.

Each type of sensor fits inside an architecture arranged around common interfaces and communication structures. They are characterized by similar menus, displays, totalizers, Teach-In and volumetric calibration functions. Standard industry voltages, certifications, standards, and factory calibration certificates are always available. Materials such as stainless steel PEEK, ceramics, and PVDF are used to ensure long life and chemical compatibility.

Flow expertise combined with our valve history is a perfect match for simple and accurate batch control and fast acting ratio control. The interface with our valves is designed to be as simple as possible and complete PID flow loops can be made with just two components.

We make ideas flow.



Flow Measuring Principles

Paddle wheel sensors may be differentiated by the material used for the paddle wheel (plastic or stainless steel) or on the basis of signal detection/evaluation (coil sensor, HT coil sensor, Hall sensor or optical sensor). This results in four different paddle wheel versions whose principles are described here.

Plastic paddle wheel (PVDF or PP) with inductive detection and pulse output

A PVDF or PP paddle wheel with four molded permanent magnets in the arms rotates on a precision, wear resistant ceramic spindle and two ceramic bearings. A Hall sensor detects the magnetic field of the rotating paddle wheel is placed outside of the fluid area. Two output signals are generated per revolution and the frequency changes proportionally with the speed of rotation of the paddle wheel. An integrated electronics board converts this signal to a square-wave frequency signal.

Plastic paddle wheel (PVDF or PP) with inductive detection and sinusoidal output

A PVDF or PP paddle wheel with four molded permanent magnets in the arms rotates on a precision, wear resistant ceramic spindle and two ceramic bearings. A coil with a ferrite core, detecting the magnetic field of the rotating paddle wheel, is placed outside of the fluid area. The frequency and voltage change in proportion to the rotational speed of the paddle wheel and two positive signals are generated per re-revolution. The rotation of the paddle wheel generates a sinusoidal voltage signal in the coil proportional to the flow rate. This sensor is two-wire and requires no additional auxiliary energy supply. A connected, battery-operated display unit allows operation independent of mains voltage.

Plastic paddle wheel (PVDF) with optical detection and pulse output

The paddle wheel is made of PVDF material and the spindle and two bearings are made of wear-resistant ceramic material (Al_2O_3). Two infrared transmitters (IR) and receivers are placed in the electronics housing outside of the medium area, separated by plastic which allows infrared radiation to pass through it. The rotation of the paddle wheel is detected with these IR diodes and the integrated electronics converts the reflected IR-Signal to a square wave frequency signal, proportional to the flow rate. This optical method allows the flow rate to be detected in media with ferromagnetic particles and to detect the direction of the flow.

Stainless steel paddle wheel with inductive detection and pulse output

This paddle wheel consists of stainless steel with very low ferromagnetic characteristic. The spindle is made of a high-tech ceramic or stainless steel and the bearing is made of PEEK or ceramic. Inside the top-mounted electronics is a HT coil with permanent magnets and electronics which converts the coil signal into a square wave frequency signal proportional to the flow rate. The frequency changes in proportion to the speed of rotation of the paddle wheel. Two positive output signals are generated per revolution. This method is particularly used for media with temperatures up to 160°C (320°F). Ferromagnetic particles and contaminants in the fluid do not restrict the range of application.

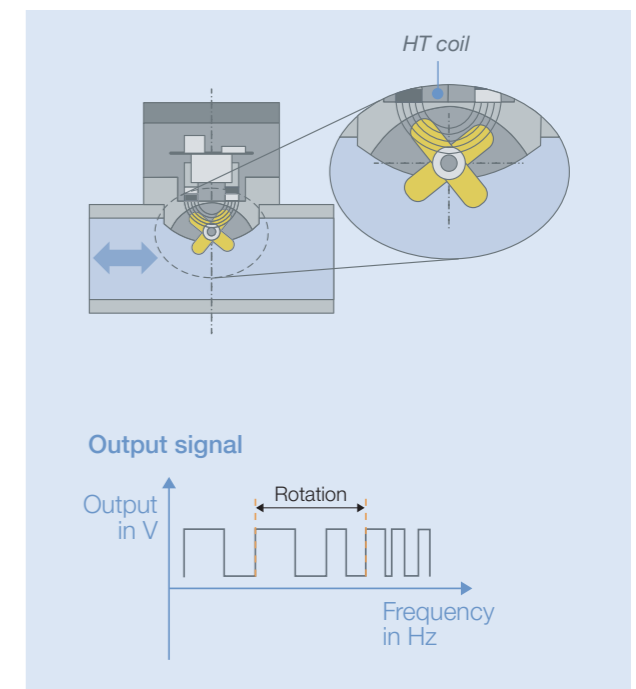
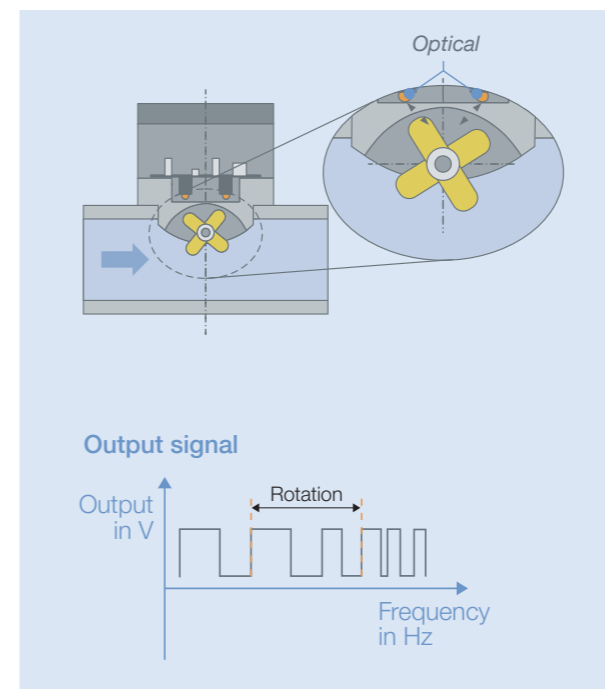
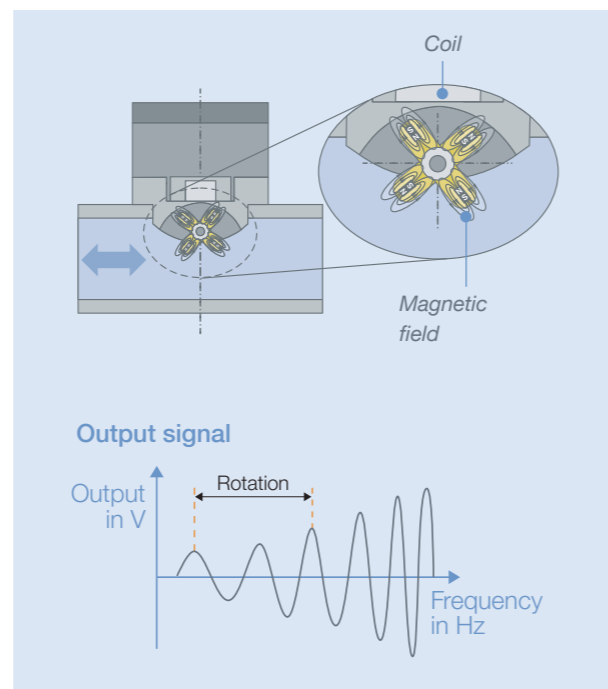
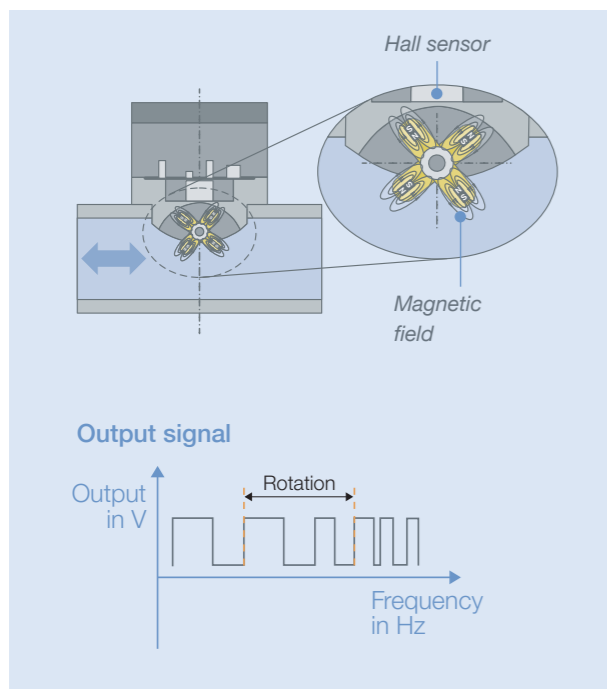

Plastic paddle with magnetic detection and switch output

A permanent magnet is integrated into a paddle. The paddle is able to turn on a stainless steel spindle in the flow cross-section and is in vertical position if there is no flow. A reed contact is positioned above the paddle outside the medium area in the electronics housing. If a specific flow velocity is exceeded, the paddle is deflected in flow direction and switches the reed contact. The switching point can be set for increasing and decreasing flow velocities by means of an adjusting screw. The devices are available in the following versions:

- Normally open (NO).
The flow closes the contact.
- Normally closed (NC).
The flow opens the contact.

Volumetric flow measuring: oval gear with inductive detection and pulse output

Two toothed oval rotors, mounted perpendicular to the flow direction in a special housing, are forced to rotate by a flowing fluid. Each rotor transmits fluid from inlet to outlet and forms a closed compartment when its major axis is aligned with the main flow direction. The volume passed per revolution of each rotor is four times the volume between the rotor and the oval housing when the rotor is confining liquid. Two small permanent magnets positioned in one of the oval gears are used to detect the rotary movement. A Hall sensor which detects the magnetic field of the oval gear and generates two square-wave output signals is placed outside of the medium area in an electronics housing. The number of pulses is directly proportional to the number of chamber volumes pumped and therefore making this method particularly suitable for flow measurement of viscous media even at high pressure.

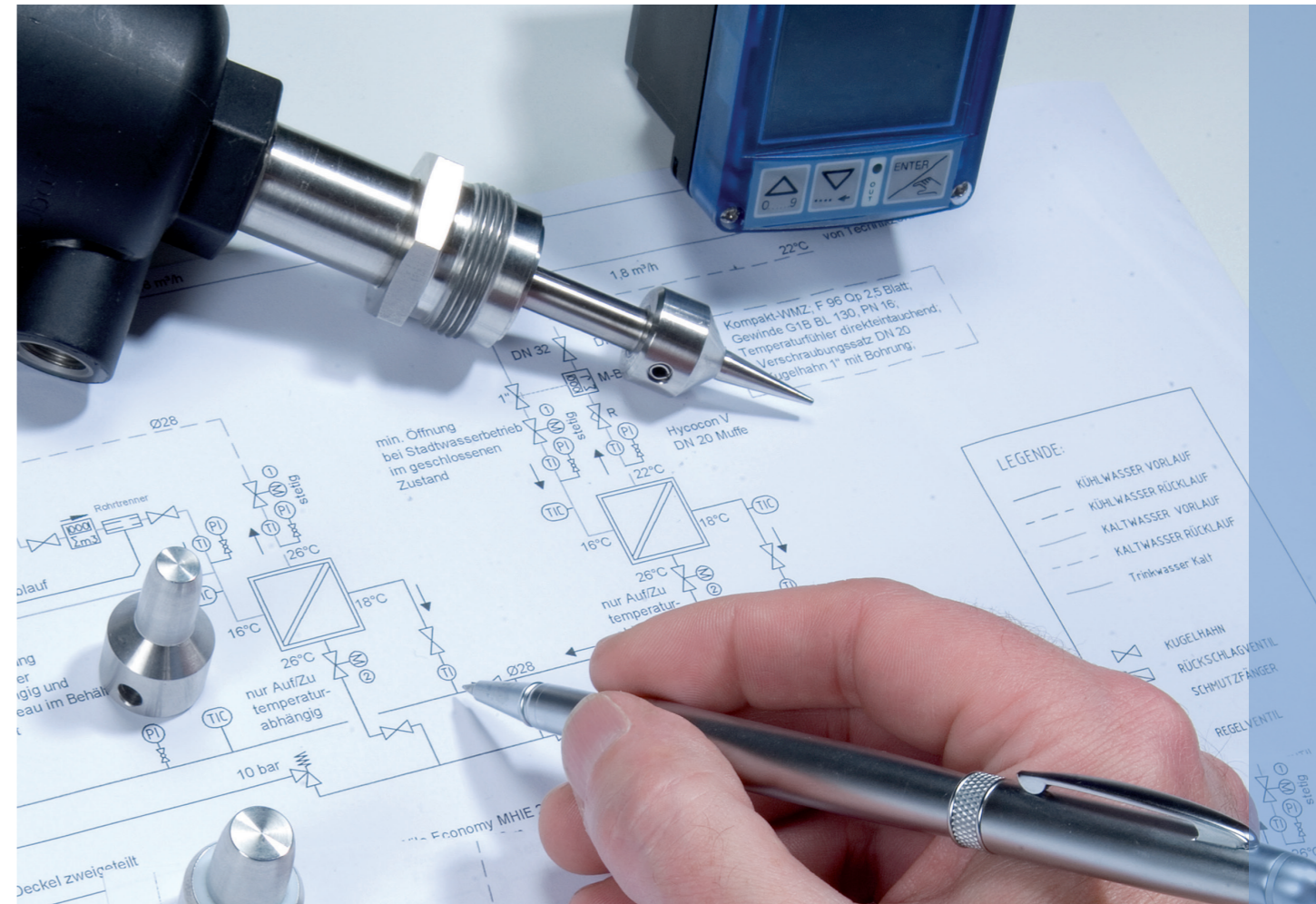
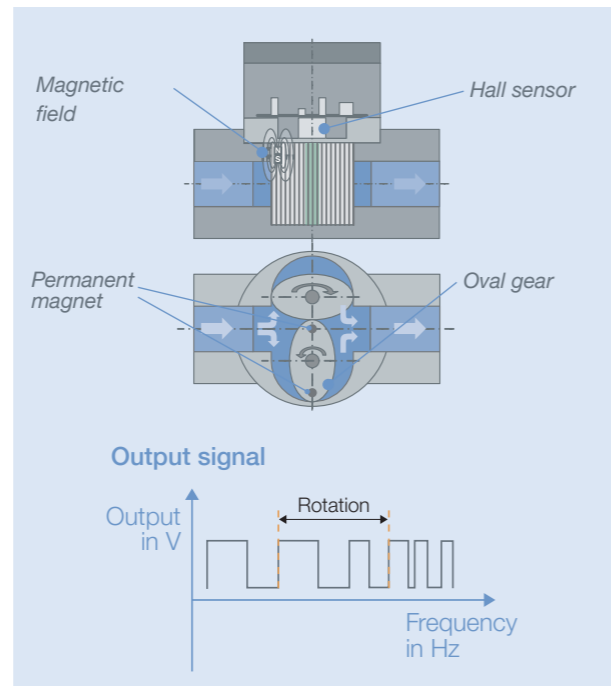
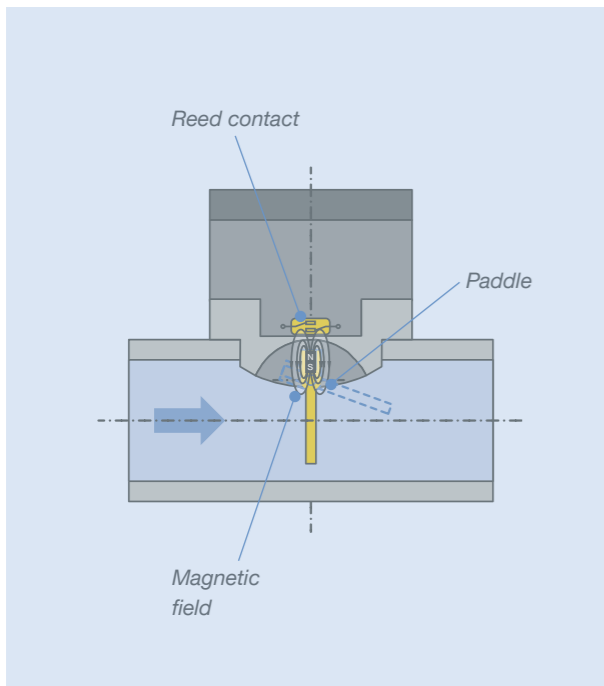

Measuring Principles – Non Moving Parts

Magnetic inductive flowmeters

Magnetic inductive flowmeters, also known as magmeters, obtain the flow velocity by measuring the changes of induced voltage of the conductive fluid passing across a controlled magnetic field. Magmeters may be designed as full bore magmeters or insertion magmeters.

Insertion magmeter

An insertion finger sensor element is mounted on one wall side and is in contact with the fluid. An electric coil which is placed near the top of the finger generates a constant alternating magnetic field (B) in the flow path. According to Faraday's law of electromagnetic induction, a conductive fluid passing across the magnetic field induces a current flow between the two electrodes which can be measured as a voltage. The two electrodes are placed at the tip of the flow finger. The higher the flow speed (v), the higher the created voltage. Integrated electronics convert the voltage signal into a standard signal (e.g. 4 - 20 mA or pulse).

The design of the insertion magmeter is very compact and can also be easily installed into existing pipe systems. Insertion magmeters are suitable for flow measurement of virtually all conductive fluid media – even with a high level of contamination. Only non-conductive fluids $<20 \mu\text{s}$, coating type liquids or highly abrasive fluids restrict application options. Due to the fact that only one point of the pipes cross section is used to measure the fluid velocity, the accuracy is slightly less than that of a full bore magmeter.

Full bore magmeter

Two electrical coils are placed around the pipe of the flow to be measured and sets up a pair of electrodes across the pipe wall. The two coils generate a constant and homogeneous alternating magnetic field in the flow cross section. According to Faraday's law of electromagnetic induction, a conductive fluid passing across the magnetic field induces a current flow between the two electrodes which can be measured as a voltage. The higher the flow speed v, the higher the created voltage. Integrated electronics convert the voltage signal into a standard signal (e.g., 4 - 20 mA or pulse).

For the full bore magmeter, the induced voltage is detected by electrodes, which are arranged directly opposite of each other measuring the induced voltage of the entire pipe cross section. The advantage is that the entire flow profile can be detected. This results in very precise measurement of the medium velocity. Only non-conductive fluids $<5 \mu\text{s}$, fluids causing coatings or highly abrasive fluids restrict application options.

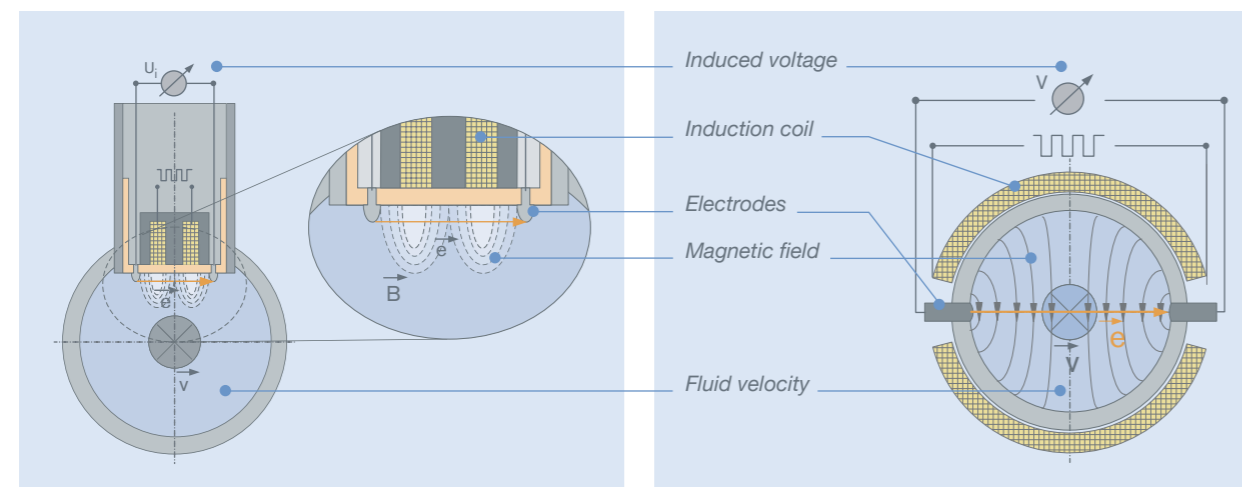

Ultrasonic flowmeter

A pair of transducers each working as a receiver or transmitter, are placed in the wall pipe with a specific distance (L). Both transducers send out an acoustic wave signal at the same time to the downstream and the upstream receiver. The signals are reflected by two mirrors; one on the upstream side of the pipe and the other on the downstream side of the pipe. The traveling time of both signals is measured by an integrated electronic board. The time for acoustic waves to travel from the upstream transducer 1 to the downstream transducer 2 is shorter than the time it requires for the same waves to travel from the downstream to the upstream. The difference in traveling time is directly proportional to the flow speed (V). The larger the difference, the higher the flow velocity. With this measuring principle it is possible to measure all kinds of water based fluids with a turn down ratio of up to 1:250. Conductive as well as non conductive fluids can be measured without any problems and having no moving parts means the maintenance costs are negligible.

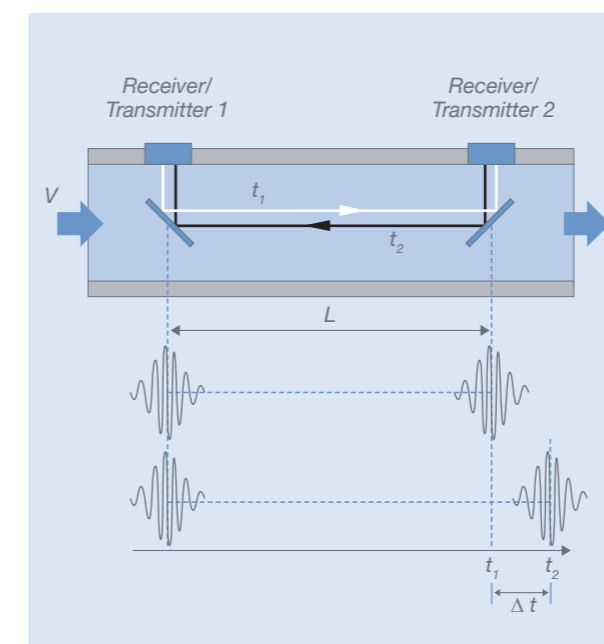

Differential pressure flowmeter

Differential pressure flowmeters employ the Bernoulli equation that describes the relationship between pressure and flow velocity.

A flat orifice plate with an opening is inserted into the pipe and placed perpendicular to the flow stream. As the fluid passes through the orifice plate, the restricted cross section area causes an increase in velocity and decrease in pressure. The pressure difference before and after the orifice plate is used to calculate the flow velocity. The larger the pressure difference, the higher the flow velocity. The turn down ratio between smallest and highest measurable flow is about 10:1. Conductive as well as non conductive fluids can be measured without any problems. Having no moving parts, the maintenance costs are negligible. The measurable liquids can vary between clean, dirty and viscous fluids. Depending on the orifice plate size, it may be necessary to filter the fluid.

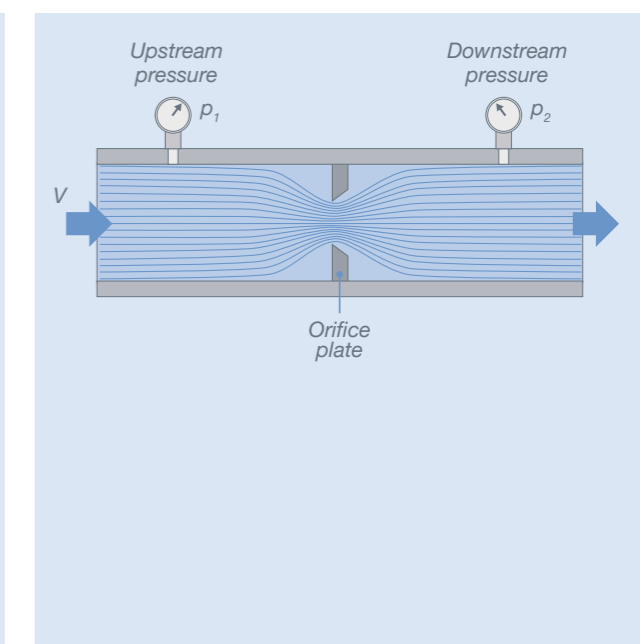

Surface Acoustic Wave (SAW) Flowmeter

This line of flowmeter which is called FLOWave is based on acoustic waves propagating on the surface of the measuring tube and in the liquid flowing through.

No sensor elements are located inside the measuring tube. Four interdigital transducers are placed outside of the tube on its surface. These IDTs consist of a specific piezo material with certain dimensions and special designed electrodes.

Per tube size their positions on the tube are optimized to maximize the effects which are needed to get accurate measurements.

The IDTs are excited by high frequency (> 1 MHz) pulses and by this they emit surface acoustic waves. These waves propagate on the surface of the measuring tube and as well couple out to the liquid inside the tube.

Each IDT acts as sender and as receiver. No. 1 and 4 are sending in the direction of no. 2 and 3, no. 2 and 3 are sending in the direction of no. 1 and 4.

IDTs only receive surface acoustic waves traveling on the surface of the tube.

With just the excitation of IDT 1 the signals are created named as 1 WG (1st wave Group) up to 5 WG represented by the different colours (see graphic above – e.g. the green line creates the signal circled in green).

The waves traveling from sender to receiver need different absolute travelling time and the longer the time the more they are influenced by properties of the liquid, e.g. gas bubbles inside or viscosity.

The red signal propagates from IDT1 to IDT 2 on the surface of the tube. The absolute travelling time allows calculating the temperature of the tube which in a stable situation is equal to the liquid temperature.

A huge part of the energy couples out as wave to the liquid. This happens with a certain angle called Rayleigh angle which is a relation between the propagation speed of the wave on the surface of the tube and the propagation speed of the wave in the liquid.

E.g. the green line representing a wave in the liquid creates a wave on the surface of the tube which propagates to IDT 3.

This surface wave itself creates a wave in the liquid gain (yellow colour) propagating to the other side of the tube and there propagating as surface acoustic wave to receiver 2. These effects continue represented by the orange, magenta and blue lines.

The information of the flow velocity is represented by the time difference of a wave traveling in flow direction compared to the time of a wave traveling against the flow direction. It is possible to do this several times, e.g. WG1 forward against WG1 backward and WG2 forward against WG2 backward. The flow volume then is calculated by the time differences which give the flow velocity and the tube cross section size. Just having IDT 1 and IDT 3 would allow having a flow measurement.

The design with four IDTs could give a multiple flow measurement and allows correlating all signals to give more information than just flow.

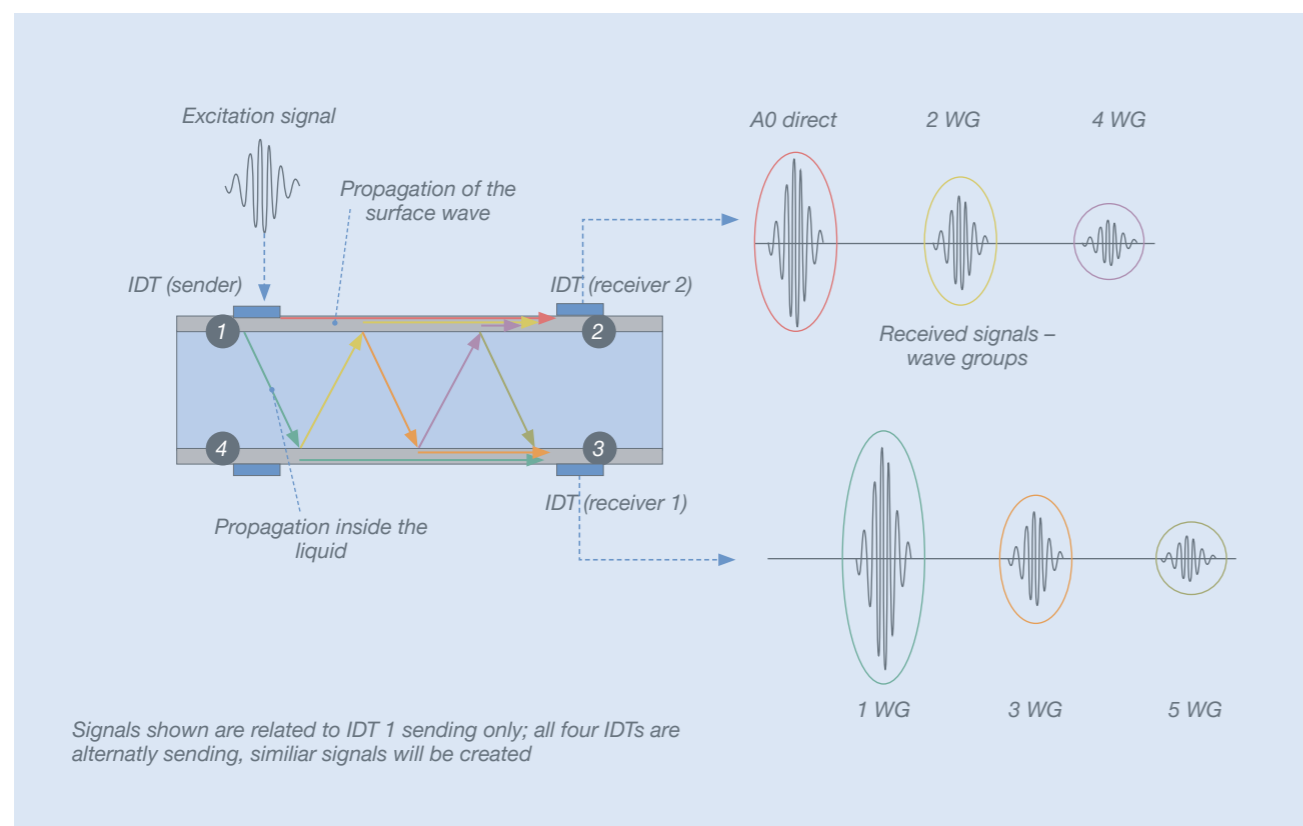

Flow Range – SAW (Surface Acoustic Waves)

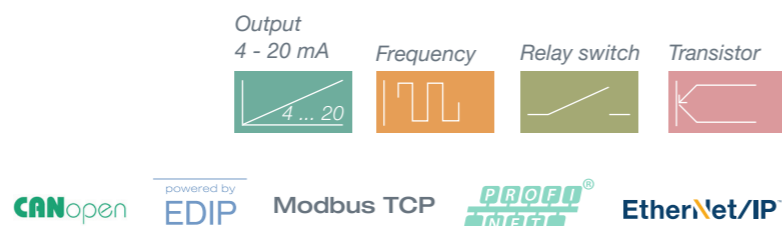

Compact transmitter



8098



FLOWave L

8098



FLOWave S

Sensor

Flow – Features

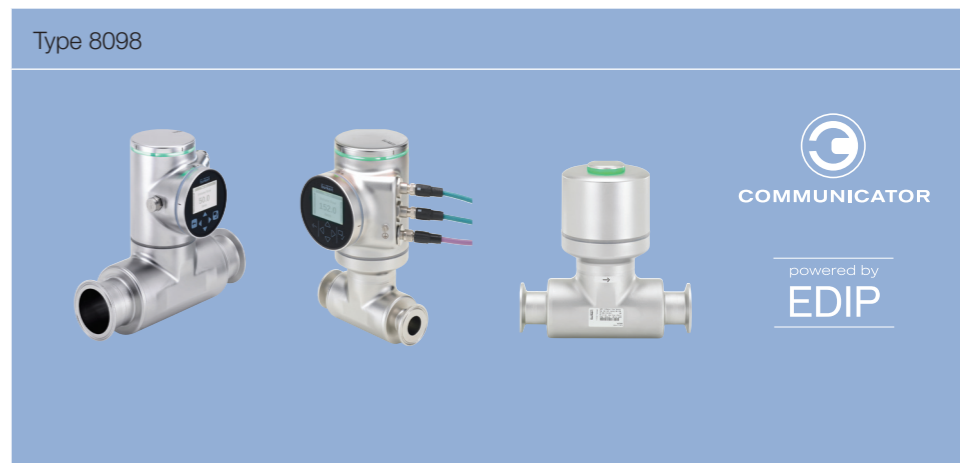

Sensor principle	SAW
Nominal diameter	¾" DN15 1" DN25 1 ½" DN40 2" DN50
Max. flow rate [m³/h]	7 10 14 25 35 56 64 90
Max. flow rate [US GPM]	31 44.0 61.6 110 151 246.5 281.8 396
Turndown ratio	1:100
Measurement deviation volume flow	0.4% o.r. for 1m/s to 10 m/s, 0.08% F.S. for 0.1 m/s to 1 m/s
Measurement deviation temperature	1°C (< 100 °C), 1.5 °C (>100 °C)
Medium temperature	Max. 110°C, 140°C for 1 h, details in temperature diagram ambient vs medium
Pressure range	PN25 (DN15, DN25, ¾", 1", 1 ½"), PN16 (DN40, DN50, 2")
Protection class	IP65, IP67, NEMA250 4x
Wetted parts: Measuring tube and process connection	316L / 1.4435 BN2
Conductivity	Measurement is independent from conductivity
Characteristics	
Basic function	Switch, sensor, transmitter, 2 volume flow totalizers
Outputs	2 AO, 1 DO or 1 AO, 2 DO (selectable by configuration), Industrial Ethernet, CANopen
Display	2.4" graphic display (240*160 pixel)
Approvals / certificates	EHEDG, 3A, ASME BPE

Flow Range – Paddle Wheel Sensors

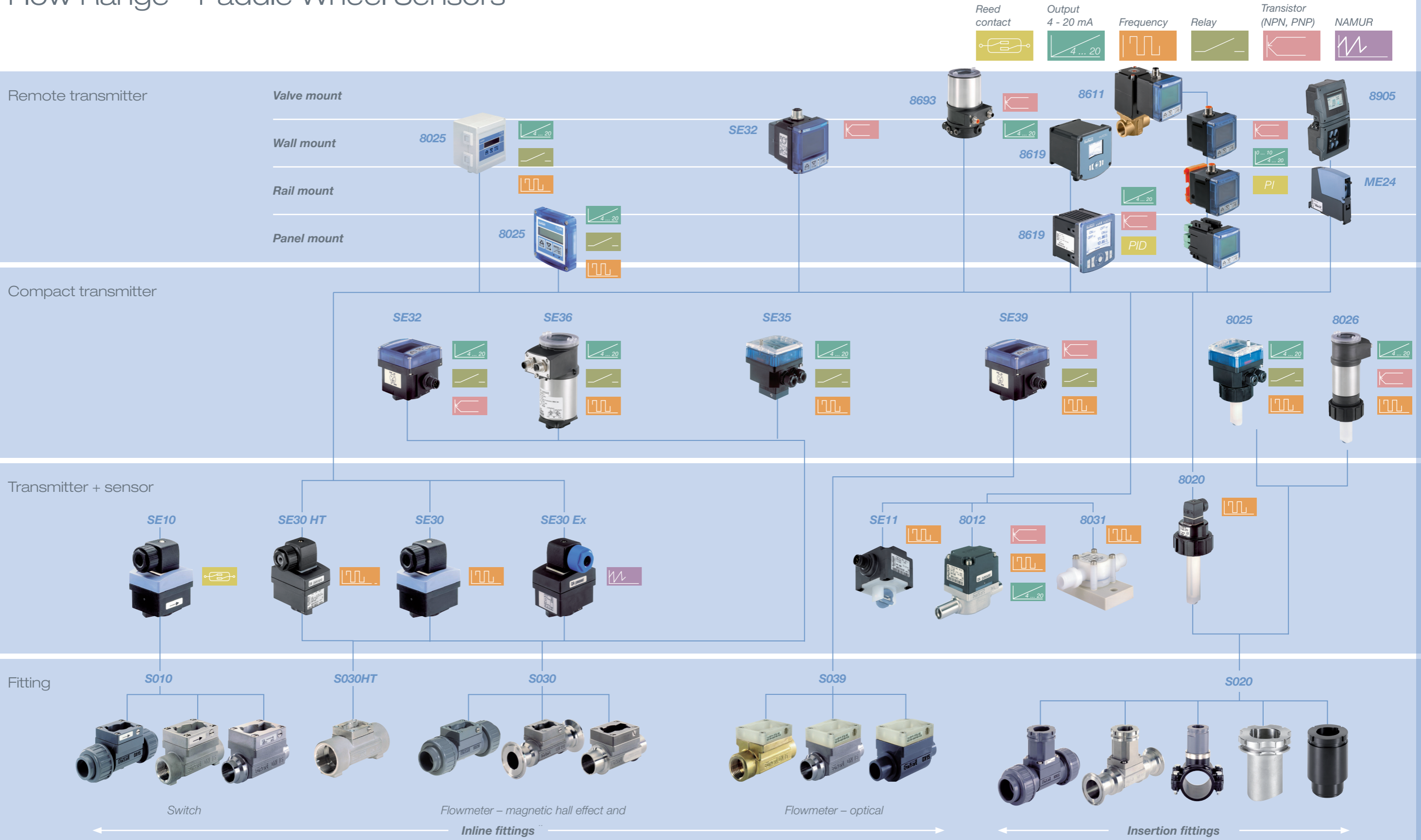

A complete measurement device consists of transmitter + sensor + fitting
 SExy mainly characterizes a transmitter, S0xy mainly characterizes a fitting
 A type number 80xy characterizes a combination of transmitter+sensor

Flow Features – Paddle Wheel

Please see datasheets for further information.

Sensors which provide perfect performance for clean, neutral or aggressive liquids in moderate pressures and temperatures

Some versions offer approvals, see individual datasheets



Sensor type	8010	SE11	8012	8030Ex	8030 HT	8030	8032	8035/8036	8039	8020	8025/8026	8031
Sensor principle	Reed contact	Hall	Hall or optical	Hall	HT-coil	Hall	Hall	Hall	Optical	Hall	Hall	Hall
Flow rate range [l/min] Flow rate range [GPM]	4 - 1000 1 - 265	0.5 - 1000 .13 - 265	0.5 - 1000 .13 - 265	0.5 - 1000 .13 - 265	0.85 - 1000 .22 - 265	0.5 - 1000 .13 - 265	0.5 - 1000 .13 - 265	0.5 - 1000 .13 - 265	0.5 - 1000 .13 - 265	0.5 - 75000 .13 - 19,813	0.5 - 75000 .13 - 19,813	0.16 - 4 .04 - 1
Temperature/pressure range	See P/T chart pages 46/47	See P/T chart pages 46/47	See P/T chart pages 46/47	See P/T chart pages 46/47	See P/T chart pages 46/47	See P/T chart pages 46/47	see P/T chart pages 46/47	See P/T chart pages 46/47	See P/T chart pages 46/47	See P/T chart pages 46/47	See P/T chart pages 46/47	6bar (87psi) at 20 °C (68°F) Max 80 °C (176°F)
Nominal diameter	DN15–DN50 (½"–2" NPT)	DN6–DN50 (¼"–2" NPT)	DN6–DN50 (¼"–2" NPT)	DN6–DN50 (¼"–2" NPT)	DN6–DN50 (¼"–2" NPT)	DN6–DN50 (¼"–2" NPT)	DN6–DN50 (¼"–2" NPT)	DN6–DN50/65 (¼"–2" NPT)	DN6–DN50 (¼"–2" NPT)	DN15–DN400 (½"–16")	DN10/15–DN400 (½"–16")	G & NPT ⅜"– G ¼"
Wetted parts												
Paddle wheel	PVDF	PVDF	PVDF	PVDF	SS	PVDF	PVDF	PVDF	PVDF	PVDF	PVDF	POM/ECTFE
Axis/bearing	Ceramic/Ceramic	Ceramic/Ceramic	Ceramic/Ceramic	Ceramic/Ceramic	Ceramic/Ceramic or Steel/PEEK	Ceramic/Ceramic	Ceramic/Ceramic	Ceramic/Ceramic	Ceramic/Ceramic	Ceramic/Ceramic or Steel/PEEK	Ceramic/Ceramic	Corepoint/ Sapir/Rubin
Seal	FKM, EPDM	FKM, EPDM	FKM, EPDM	FKM	FKM, EPDM	FKM, EPDM	FKM, EPDM	FKM, EPDM	FKM, EPDM	FKM, EPDM	FKM, EPDM	FKM, EPDM, FFKM
Body	PVC, PP, PVDF, Br, SS	PVC, PP, PVDF, Br, SS	PVC, PP, PVDF, Br, SS	PVC, PP, PVDF, Br, SS	SS	PVC, PP, PVDF, Br, SS	PVC, PP, PVDF, Br, SS	PVC, PP, PVDF, Br, SS	SS, Br	PVC, PP, PVDF, Br, SS	PVC, PP, PVDF, Br, SS	POM, ECTFE
Fluid properties	No fibres No ferromagnetic parts. < 1% contaminants	No fibres No ferromagnetic parts. < 1% contaminants	No fibres < 1% contaminants	No fibres No ferromagnetic parts. < 1% contaminants	No fibres < 1% contaminants	No fibres No ferromagnetic parts. < 1% contaminants	No fibres No ferromagnetic parts. < 1% contaminants	No fibres No ferromagnetic parts. < 1% contaminants	No fibres < 1% contaminants	No fibres No ferromagnetic parts. < 1% contaminants	No fibres No ferromagnetic parts. < 1% contaminants	No fibres No ferromagnetic parts. < 1% contaminants
Viscosity [cSt]	<300	<300	<300	<300	<300	<300	<300	<300	<300	<300	<300	<5
Conductivity [µS/cm]	No affect	No affect	No affect	No affect	No affect	No affect	No affect	No affect	No affect	No affect	No affect	No affect
Fitting type	S010	S012	S012	S030	S030 HT	S030	S030	S030	S039	S020	S020	Integrated
Turndown	N/A	1:33	1:33	1:33	1:20	1:33	1:33	1:33	1:33	1:33	1:33	1:12
Electrical characteristics												
Basic function	Switch	Sensor	Sensor, Transmitter, Switch	Sensor	Sensor	Sensor	Sensor, Transmitter, Switch	Sensor, Transmitter, Switch, Batch, Totalizer	Sensor, Switch	Sensor	Sensor, Transmitter, Switch, Batch, Totalizer	Sensor
Output	Reed contact NO/NC	Pulse	4-20 mA, Pulse, Transistor	NAMUR	Pulse	Pulse	4-20 mA, Pulse, Transistor	4-20 mA, Pulse, Transistor, Relay	Pulse, Transistor, Relay	Pulse	4-20 mA, Pulse, Transistor, Relay	Pulse
Display	No	No	No	No	No	No	Yes, removable	Yes, removable	Yes	No	Yes, removable	No
Specifics	Compact	Compact	Compact	Compact	Compact	Compact	Compact, Wall	Compact, Wall	Compact	Compact	Compact, Wall, Panel	Compact

Flow Range – Oval Gear Sensors

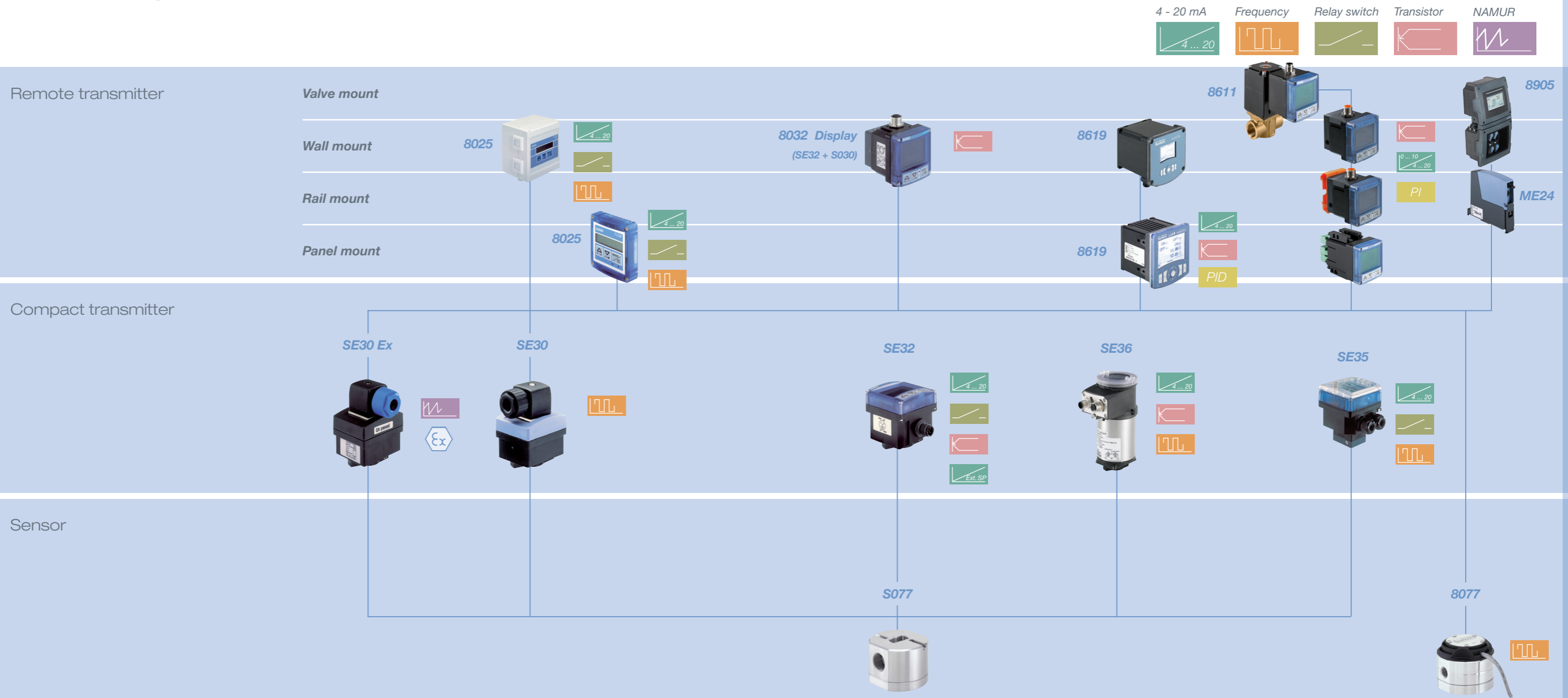

Flow Features – Oval Gear

Sensors for clean viscous fluids where low flow is required

Please see datasheets for further information.



Fluidic characteristics					
Sensor principle	Hall	Hall	Hall	Hall	Hall
Flow rate range [l/min] Flow rate range [GPM]	0.008 - 8.33 0.002 - 2.2	2 - 1200 0.50 - 320	2 - 1200 0.50 - 320	2 - 1200 0.50 - 320	2 - 1200 0.50 - 320
Temperature/pressure range	55 bar (800psi) at 120 °C (248°F)	55 bar (800psi) at 120 °C (248°F) (depending on orifice)	55 bar (800psi) at 120 °C (248°F) (depending on orifice)	55 bar (800psi) at 120 °C (248°F) (depending on orifice)	55 bar (800psi) at 120 °C (248°F)
Nominal diameter	G & NPT G ¼" and ⅜"	DN15 - DN100 (NPT ½" - 4")	DN15 - DN100 (NPT ½" - 4")	DN15 - DN100 (NPT ½" - 4")	DN15 - DN100 (NPT ½" - 4")
Wetted parts					
Rotor	PPS, SS	PPS, Aluminium, SS	PPS, Aluminium, SS	PPS, Aluminium, SS	PPS, Aluminium, SS
Axis/bearing	Hastelloy C, SS	SS	SS	SS	SS
Seal	FKM (EPDM)	FKM (EPDM or PTFE)	FKM (EPDM or PTFE)	FKM (EPDM or PTFE)	FKM (EPDM or PTFE)
Body	Aluminium, PPS, SS	AL, SS	AL, SS	AL, SS	AL, SS
Fluid properties	No fibres. No ferromagnetic parts. Filtered.	No fibres. No ferromagnetic parts. Filtered.	No fibres. No ferromagnetic parts. Filtered.	No fibres. No ferromagnetic parts. Filtered.	No fibres. No ferromagnetic parts. Filtered.
Viscosity [cSt]	<1 Mio	<1 Mio	<1 Mio	<1 Mio	<1 Mio
Conductivity [µS/cm]	No affect	No affect	No affect	No affect	No affect
Sensor		S077	S077	S077	S077
Turndown	1:50	1:25	1:25	1:25	1:25
Electrical characteristics					
Basic function	Sensor	Sensor	Transmitter, Switch	Transmitter, Switch, Batch	Sensor
Output	Pulse	Pulse	Pulse, 4 - 20 mA, Switch	Pulse, Relay, 4 - 20 mA, Switch	NAMUR NPN / PNP
Display	No	No	Yes, removable	Yes, removable	No

Flow Range – Magnetic, Ultrasonic and Differential Pressure

Output 4 - 20 mA
 Frequency
 Relay switch
 Transistor
 NAMUR

Remote transmitter

Valve mount

Wall mount

Rail mount

Panel mount

SE56 Standard, stainless steel

8611

8032 Display

8905

8025

SE56, Standard, carbon steel, painted

8619

PI

8619

PID

ME24

Compact transmitter / Compact flowmeter

8041

8045

8081

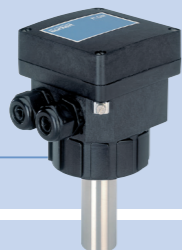

Sensor

PVDF

SS

SS

PVDF

S051

S055

S054

S056

8719
8709

8718
8708

Full bore sensors

Fitting

S020



Insertion fittings

Flow Features – Magnetic, Ultrasonic and Differential Pressure

* Higher viscosities on request.
Please see datasheets for further information.

Some versions offer approvals, see individual datasheets



Type	8041	8045	8051	8054/8055	8056	8081	8718/8719
Sensor principle	Magmeter insertion	Magmeter insertion	Magmeter full bore	Magmeter full bore	Magmeter full bore	Ultrasonic	Differential pressure
Flow rate range [l/m] Flow rate range [GPM]	0.3 - 75,000 0.8 - 19,813	0.3 - 75,000 0.8 - 19,813	0.02 - 208 .005 - 55	0.02 - 4,666 .005 - 1,233	0-02 - 4,666 .005 - 1,233	0.06 - 200 .016 - 53	0.01 - 0.6 .003 - .016
Temperature/pressure range	See P/T diagram pages 46/47	See P/T diagram pages 46/47	-20 ... 150 °C (-4 to 302°F) at 16 bar (232psi) (depending on lining)	-20 ... 150 °C (-4 to 302°F) at 16 bar (232psi) (depending on lining)	-20 ... 150 °C (-4 to 302°F) at 16 bar (232psi)	16 bar (232psi) at 5 - 90 °C (41 to 194°F)	10 bar (145psi) at 10 - 40 °C (50 to 104°F)
Nominal diameter	6–400 (1/8" – 16")	6–400 (1/8" – 16")	3 - 20 (1/4" - 1" NPT)	25–200 (1"–8") (up to 400 on request)	3–100 (DN3=1/10"–4")	15 - 25 (3/4" - 1 1/4" NPT on request)	G 1/4, NPT 1/4, flange
Wetted parts Sensorfinger Electrodes [Holder] Lining Seal Body	SS, PVDF SS/Alloy (PEEK) Analogue S020 PVC, PVDF, PP, SS	SS, PVDF SS/Alloy (PEEK) Analogue S020 PVC, PVDF, PP, SS	SS/PTFE SS, Hasteloy C, Titanium, Platinum EPDM, FKM SS	SS/PP(Ebonite)/ PTFE SS, Hasteloy C, Titanium, Platinum EPDM, FKM Carbon steel (painted)	SS/PTFE SS SS (3A)	PES (measuring tube) SS (tilting mirror) EPDM Brass	SS (orifice plate) SS FKM/EPDM/FFKM SS
Fluid properties	Clean and contaminated media ferromagnetic parts < 1 %	Ferromagnetic parts < 1 %	Contaminated or sterile fluids	Contaminated or sterile fluids	Contaminated or sterile fluids	Water-like fluids with no fibres and less than 1% solids	Water, alcohol
Viscosity [cSt]	< 1,000	< 1,000	< 2,000*	< 2,000*	< 2,000*	< 4	< 4
Conductivity [µS/cm]	> 20	> 20	> 5	> 5	> 5	No affect	No affect
Fitting type	S020	S020, Clamp	S051	S054/S055	S056	Integrated	Integrated
Turndown ratio	1:50	1:50	1:500	1:500	1:500	1:250	1:10
Characteristics							
Basic function	Sensor, transmitter	Switch, sensor, transmitter, totalizer	Sensor, transmitter, batch controller, totalizer	Sensor, transmitter, batch controller, totalizer	Sensor, transmitter, batch controller, totalizer	Sensor	Sensor, transmitter
Output	Relay, pulse, 4 - 20 mA	Relay, pulse, 4 - 20 mA	Transistor, relay, pulse, 4 - 20 mA	Transistor, relay, pulse, 4 - 20 mA	Transistor, relay, pulse, 4 - 20 mA	Pulse, 4 - 20 mA	0 - 5 V, 0 - 10 V, 0 - 20 mA, 4 - 20 mA
Display	No	Yes	Yes/no	Yes/no	Yes/no	No	LED

Batch/Ratio Controller Range

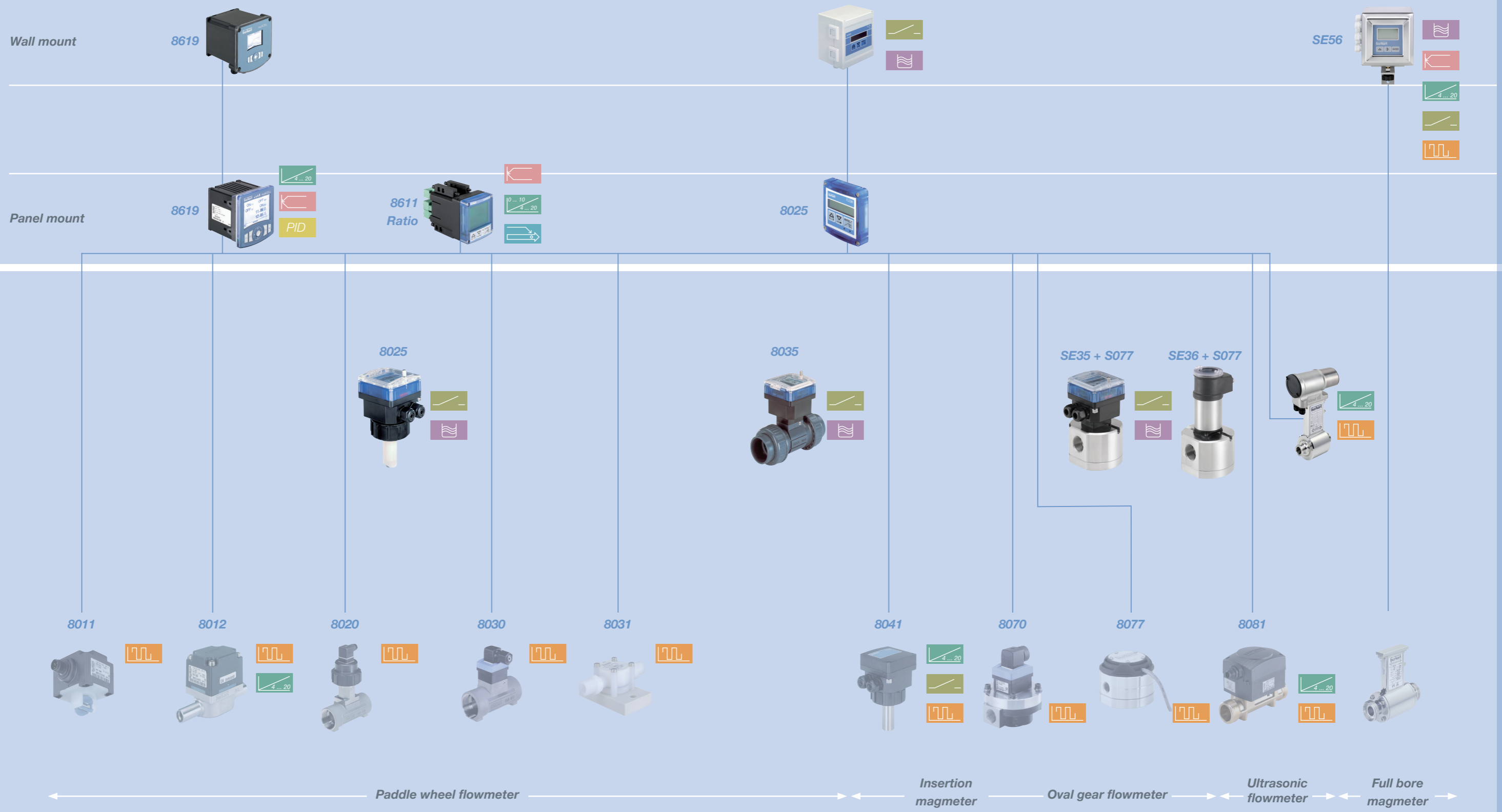
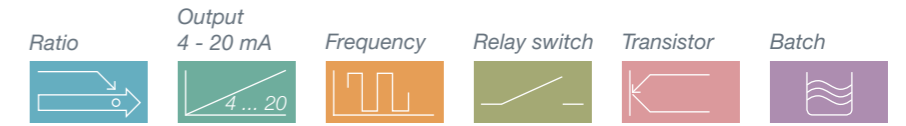

Batch Controller Features

Bürkert batch controllers can control very precise dosing and filling operations. Two switching relay outputs serve to actuate valves for a single or double stage, precise dosing function. If required, one of the relays can be used as an alarm output in the event of an incomplete batch event. The dosing operations can be started manually or automatically. The design and materials allow use in virtually all types of fluids. It is possible to select the most appropriate measuring principle (paddle wheel, oval gear, ultrasonic, full bore magmeter or insertion magmeter) depending on the properties of the medium. Selection tables, measuring principles and further information on selecting the appropriate sensor/fitting can be found in chapter 1: flow measuring.

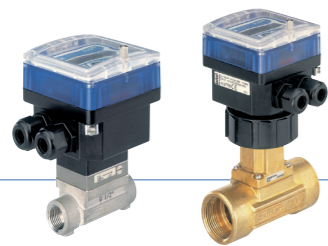

Types 8025/8035

The compact version, types 8025 or 8035, combines a paddle wheel flow sensor and an electronic module with a display in an IP65/ NEMA4 enclosure.

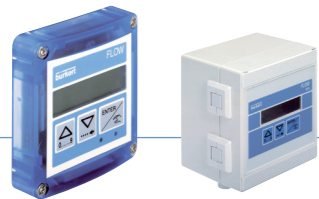

Type 8025

The remote version consists of an electronic module 8025 integrated in a front-over or integrated in an IP65 enclosure. The associated separate flow sensor should have a pulse output signal, like Bürkert sensor Types 8020, 8030... (see interconnection chart) or another flow sensor available from the market. The output signals are provided on a terminal strip.



Full bore magmeter 8051/8054/8055/8056

The full bore magmeter, 8051/8054/8055/8056, is available as remote or compact version in an IP67 enclosure. For highly precise and fast filling/dosing in hygienic applications, it is the batch controller of choice.

The following dosing and filling operations are possible with the 8025/8035 batch controllers:

- Local dosing: the user enters the quantity to be metered and initiates the dosage from the keypad.
- Local dosing with pre-set quantity: the user selects up to seven pre-set volumes and initiates the dosage from the keypad.
- Remote control dosing using a seven position rotary knob (selecting a pre-set quantity) or binary data inputs.
- Dosing controlled by a PLC unit using three binary data inputs for up to seven preselected volumes.
- Automatic dosing controlled by variation of pulse duration. The quantity of the dosing is directly proportional to the duration of a pulse.

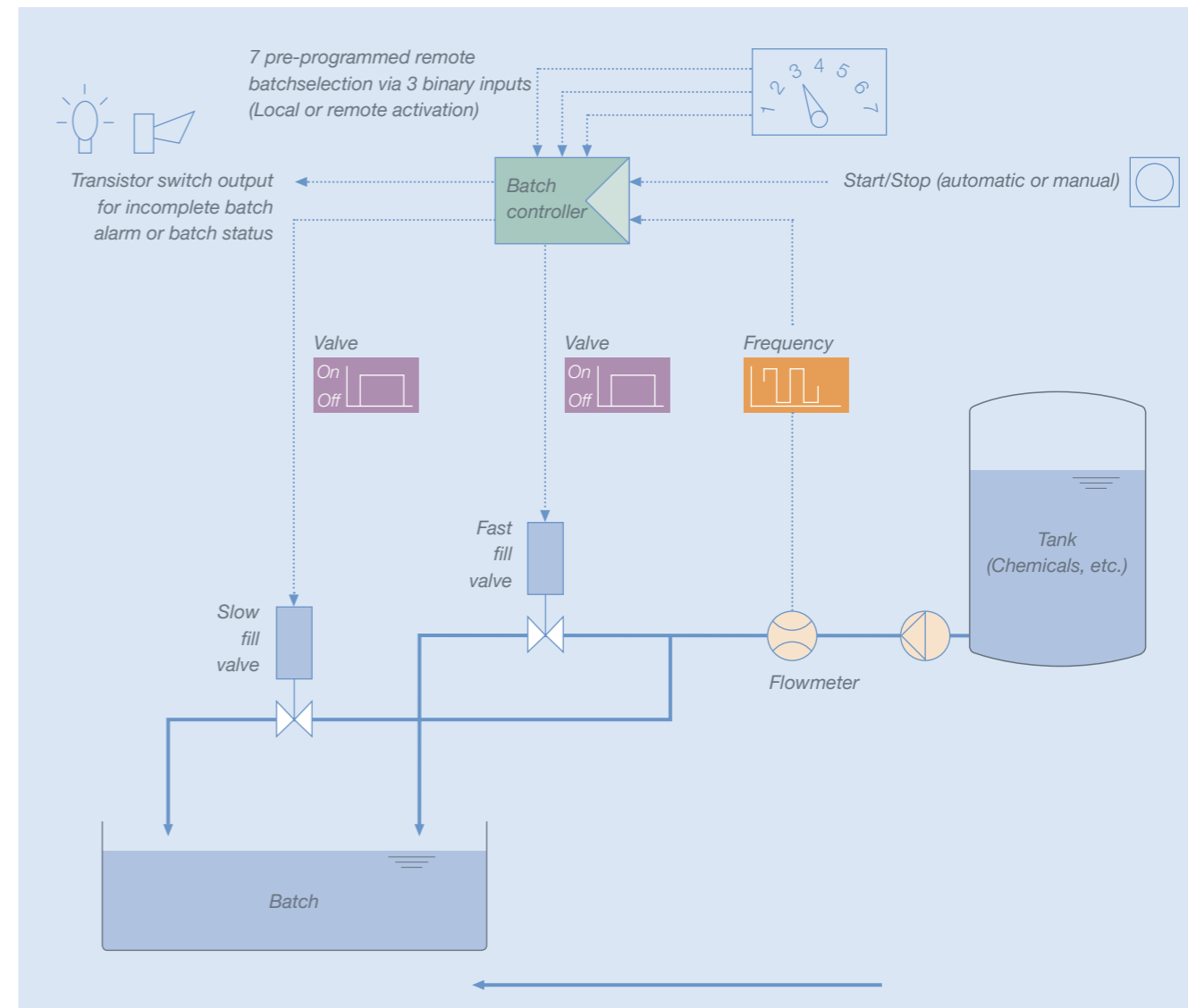

Ratio Controller Features

The Bürkert 8611 ratio controller controls the ratio between main flow (Q1) and the secondary flow (Q2) very precisely. Both are mixed together to a process flow Q3. The controller can handle two independent control loops. The following ratio control modes are possible:

Dosing in relation to uncontrolled main flow Q1:

In relation to Q1, the secondary flow Q2 can be set as ratio to Q1 (%Q1).

Dosing in relation to controlled main flow Q1:

In relation to the controlled Q1, the secondary flow Q2 can be set as a ratio to Q1 (%Q1).

For setting the main or secondary flow, the following control methods are possible:

- pump with 4-20mA signal (PUMP),
- solenoid control valves (SCV),
- process valves with 8810 positioning system (PCV) or
- any positioner with 4-20mA control signal (4-20).

For measuring the flow rate of Q1 and Q2, the following sensor types can be used:

- sensors with frequency signal (FREQ),
- sensors with 0-10V (0-10) or 4-20mA (4-20) signal.

The set point and the ratio can be set external via standard signal (4-20mA or 0-10V) or directly by the keypad.

With the binary input (B IN), it is possible to activate different control functions like HOLD, open or close the valve etc. With two binary outputs, it is possible to define alarm signals.

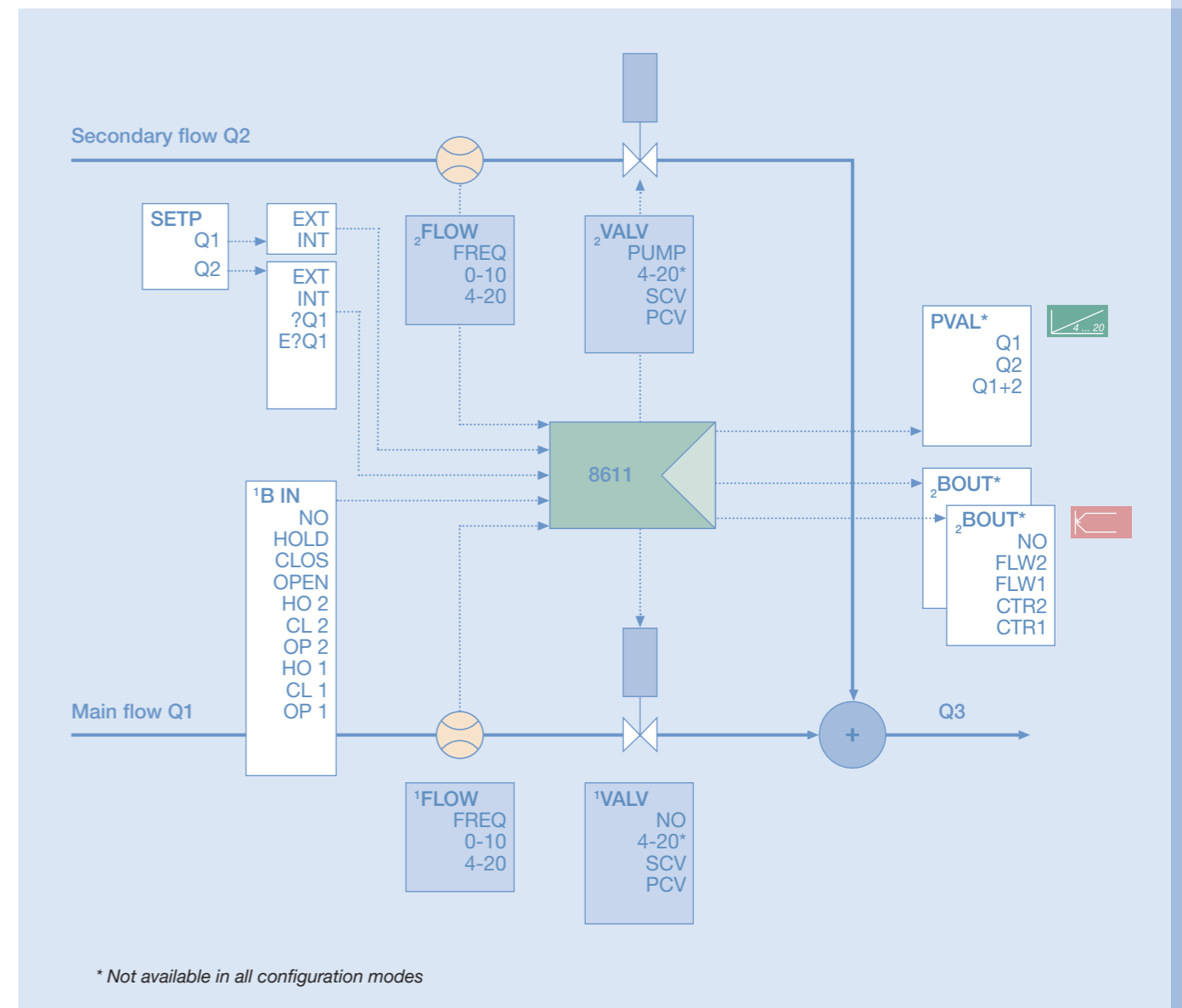

Selection help flow

This table shows the measuring range of all flowmeters depending on the flow technology.

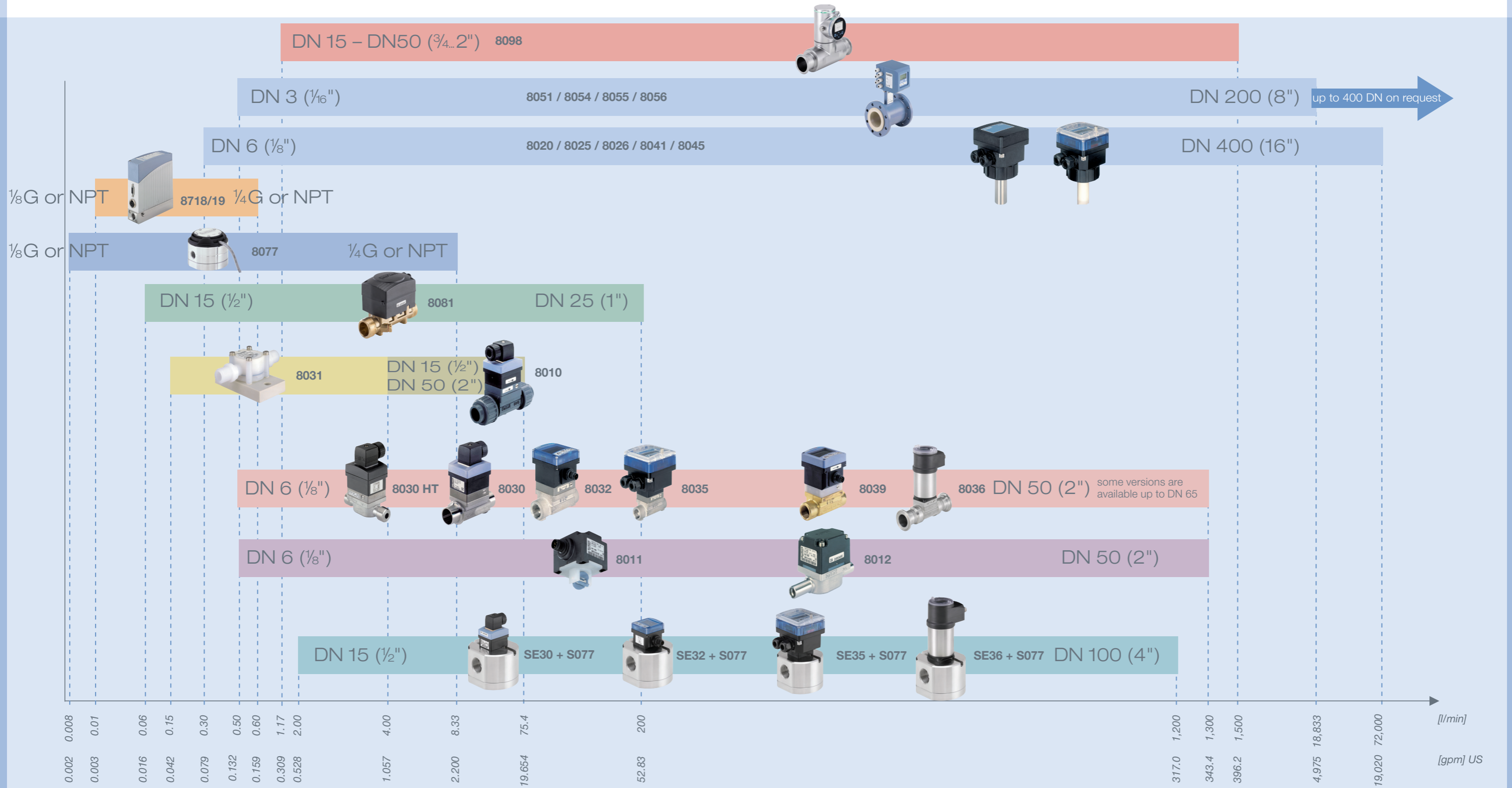

Selection Help – Flow Velocity Considerations

Depending on the sensor type, the right flow rate has to be chosen to get the best accuracy. The higher the flow velocity, the lower the measurement error, but the higher the pressure loss. On the next page you will find the relationship between flow velocity, pressure drop and accuracy (page 40-43). The following chart will help you find the correct fitting diameter for your application depending on flow velocity and sensor technology. Pipes for fluids similar to water are generally designed for an average flow velocity of approx. 2 to 3 m/s (6-10ft/s).

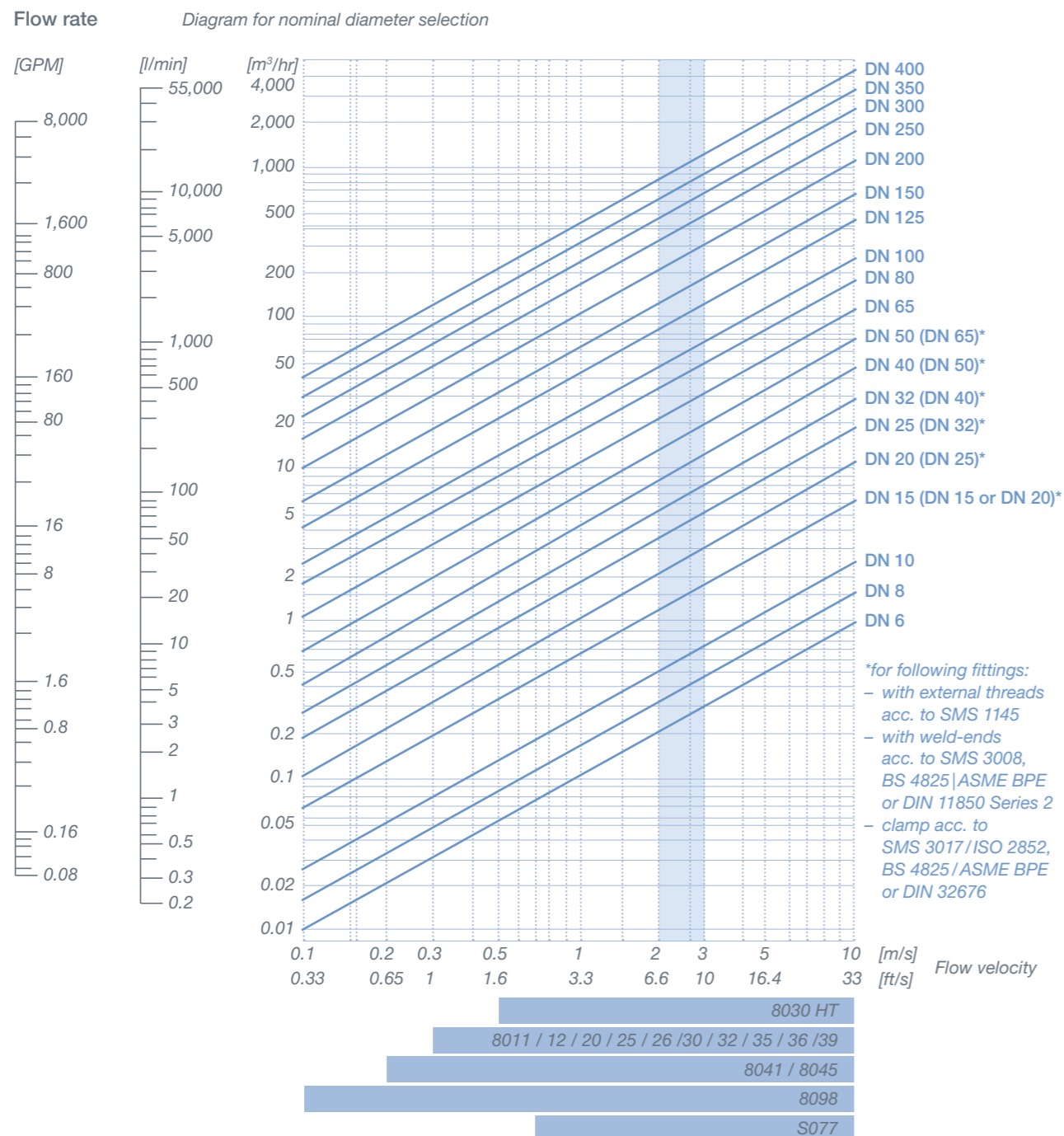

Selection Help – Viscosity Considerations

Viscosity describes the degree of internal friction (the interaction between the atoms or molecules). We distinguish between the term “dynamic viscosity” and “kinematic viscosity”. The inter-relationship between these two is based on multiplication of the relevant substance density.

$$\eta = \nu \cdot \rho$$

The below table provides a general overview of conventional media. Viscosity has a major influence on piping design and installation procedures. At a given flow velocity with an increase in fluid friction due to media becoming more viscous, pressure drop in a pipe will rise. Under this condition either the flow velocity will drop or the upstream pressure must be increased to overcome the increased fluid friction. Medium temperature also influences fluid viscosity. With water, the change in viscosity can usually be ignored, but for other media such as oil, pressure losses due to increased viscosity must always be taken into account.

Units, dynamic viscosity:

$[\eta] = 1 \text{ N/m}^2 \cdot \text{s} = 1 \text{ Pa} \cdot \text{s} = 10^3 \text{ mPa} \cdot \text{s} = 10 \text{ Poise} = 10^3 \text{ cP (centipoise)}$
 → 1 mPa s = 1 cP

Units, kinematic viscosity:

$[\nu] = 1 \text{ m}^2/\text{s} = 10^6 \text{ mm}^2/\text{s} = 10^6 \text{ cST (centistoke)}$
 → 1 mm²/s = 1 cSt

Medium/Temp. [°C]	Dyn. viscos. η [cP]	Density ρ [kg/m³]	Kinem. viscosity ν [cST]
Water 20 °C	1.01	1,000	1.01
Ethanol/20 °C	1.19	1,580	0.75
Turpentine/20 °C	1.46	860	1.70
Juice	2-5	1,040	1.93 - 4.8
Milk	5-10	1,030	4.85 - 9.7
Glycol/20 °C	19.90	1,110	17.9
Cream (body lotion)	70-150	1,050	66 - 142
Olive oil/20 °C	107.50	919	117.00
Detergent 20 °C	360.00	1,028	350.00
Transformer oil/20 °C	986.00	860	1146.50
Thin honey	1,000 - 2,000	1,400	714 - 1,428
Ketchup	5,000	1,430	3,496

Viscosity value of conventional media

Selection Help – Flowmeter Accuracy

Consideration of measurement error

A decision to opt for a specific measuring method usually depends on the required accuracy. Basically, percentages refer either to the measured value or to the full scale value. The maximum measurement error refers to the full scale value and describes the sum of all possibly occurring individual deviations and is frequently shown graphically as a bell-shaped curve. This includes:

- Linearity over the entire measuring range
- Repeat accuracy (referred to the measured value)
- Production-related tolerances
- Installation tolerances as the result of installation in the pipe system.

The production-related tolerances and installation tolerances can be eliminated by field calibration (Teach-In), greatly reducing measurement error.

Flowmeter accuracies with standard K-factor calibration

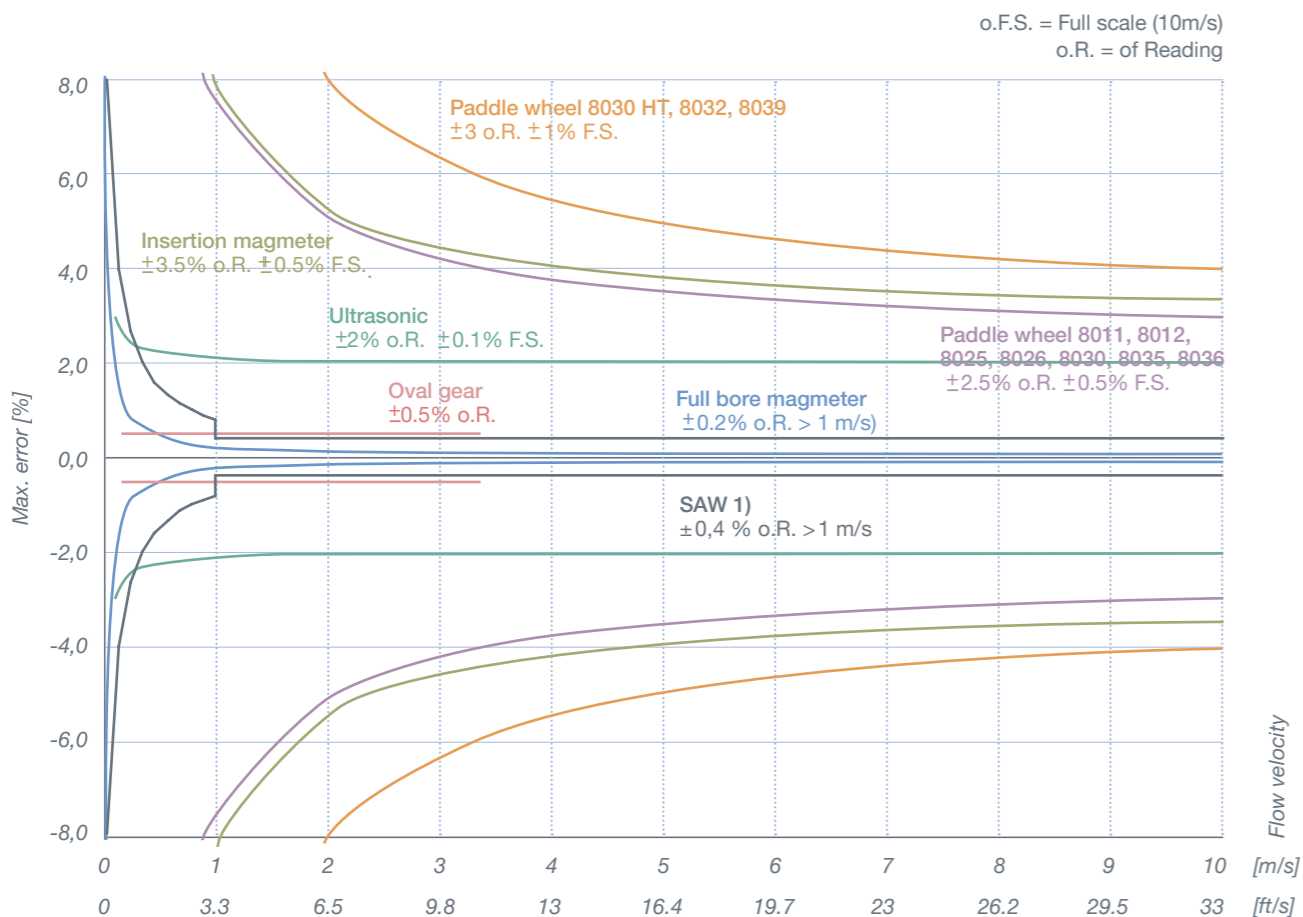

1) Surface acoustic wave in productlinie FLOWave

Selection Help – Flowmeter Accuracy with Teach-In

Teach-In calibration

Many Bürkert flow devices can be calibrated in line for the precise determination of the K-factor (proportionality factor between pulse frequency and flow rate). "Volume" Teach-In calibration involves filling a tank with a defined fluid volume. During this filling operation, the pulses generated by the flow sensor are counted by the electronics. After completion of the filling operation, the value of the filled volume is determined (e.g., with a balance or graduated container) and is entered on the keypad of the transmitter. The device calculates the determined K-factor after the entry has been confirmed. "Flow rate" Teach-In calibration involves entering the flow rate of a reference device in the same pipe on the keypad during the operation. The K-factor is calculated after this entry is confirmed.

The manuals of the flowmeters in detail describe the procedure to be followed performing Teach-In. Teach-In delivers an accuracy improvement which is mainly related to the used liquid, the liquid temperature, the process pressure and specially the flow rate. Differences to these conditions later on may result in worse measurement results compared to working without Teach-In. Please observe the possible accuracy improvements using Teach-In by checking the data sheet of the individual flowmeter type.

Flowmeter accuracies with Teach-In calibration for paddle wheel and finger magmeter

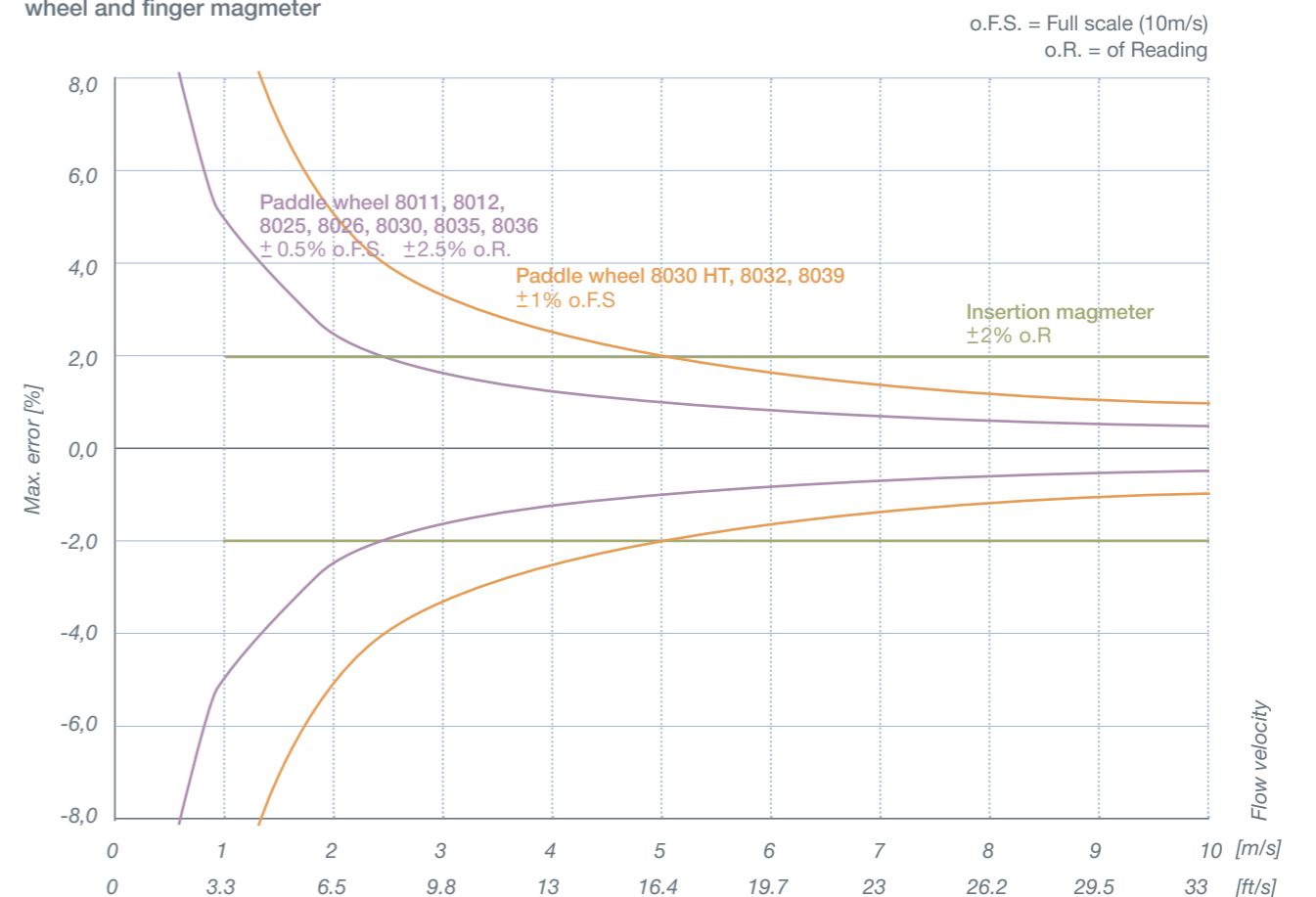

Selection Help – Pressure Drop

Pressure loss tables

A pressure loss occurs, dependent on average flow velocity, in the case of fittings and pipes. To estimate the total pressure loss in a piping system it is necessary to be aware of the individual pressure losses. Here the first three diagrams show the pressure loss of the paddle wheel types and insertion MID types for water/ 20 °C as a function of the nominal diameter and pipe connection. FLOWave does not have any parts inside the tube and as well as standard no diameter reduction which results in zero pressure drop.

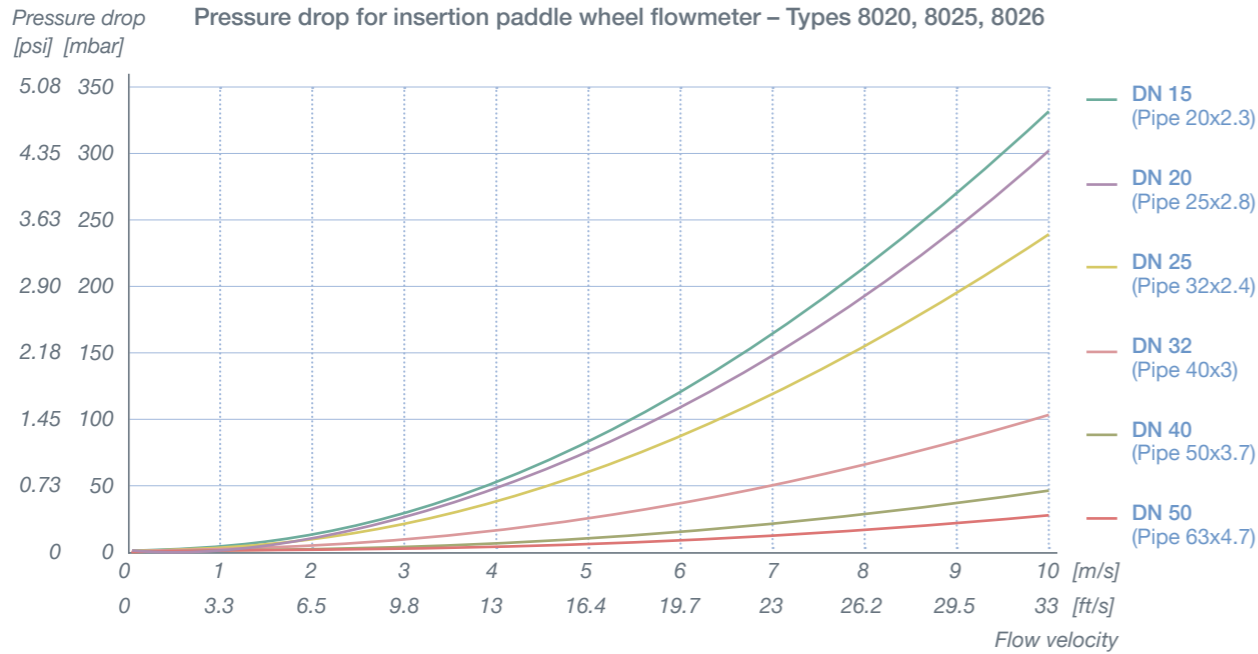

The pressure loss of the oval gear sensors depends very greatly on the viscosity of the medium while the pressure loss of fluids similar to water is virtually independent of the flow rate with this measuring principle. In more viscous media, the pressure loss increases with increasing viscosity. Likewise, it increases with rising flow velocity. The “Pressure loss, oval gear” diagram shows the pressure loss of an oval gear flowmeter 8072 with different media as a function of the flow velocity.

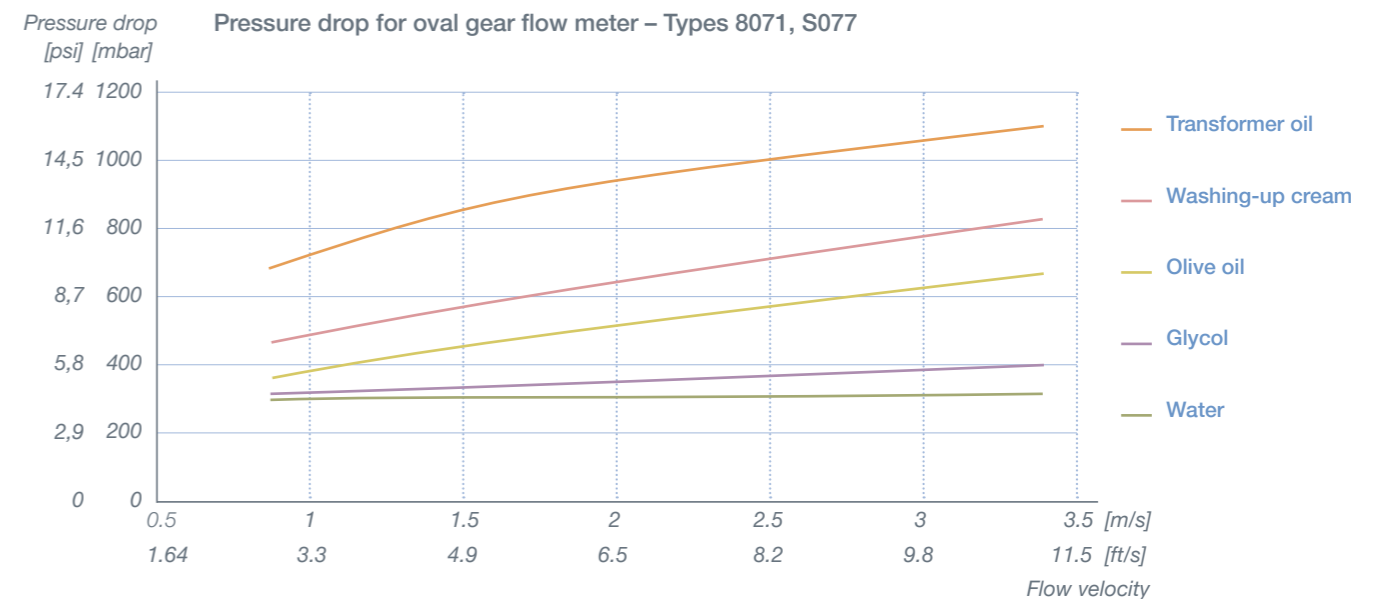
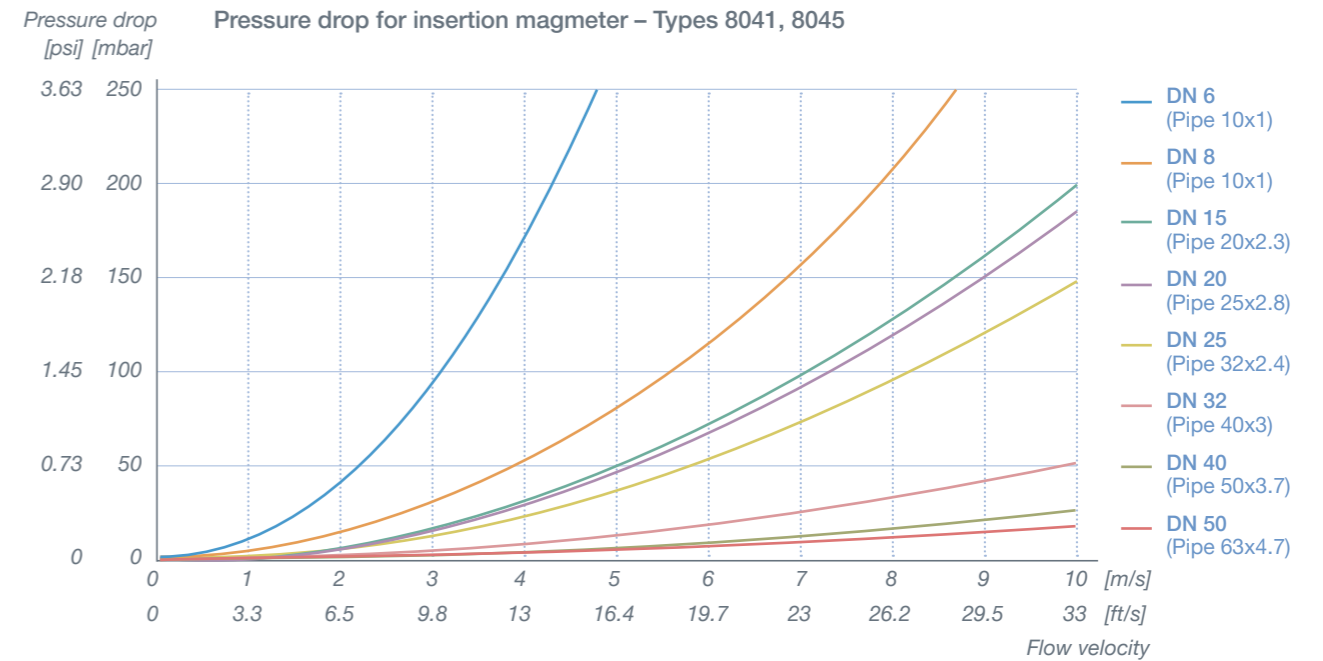
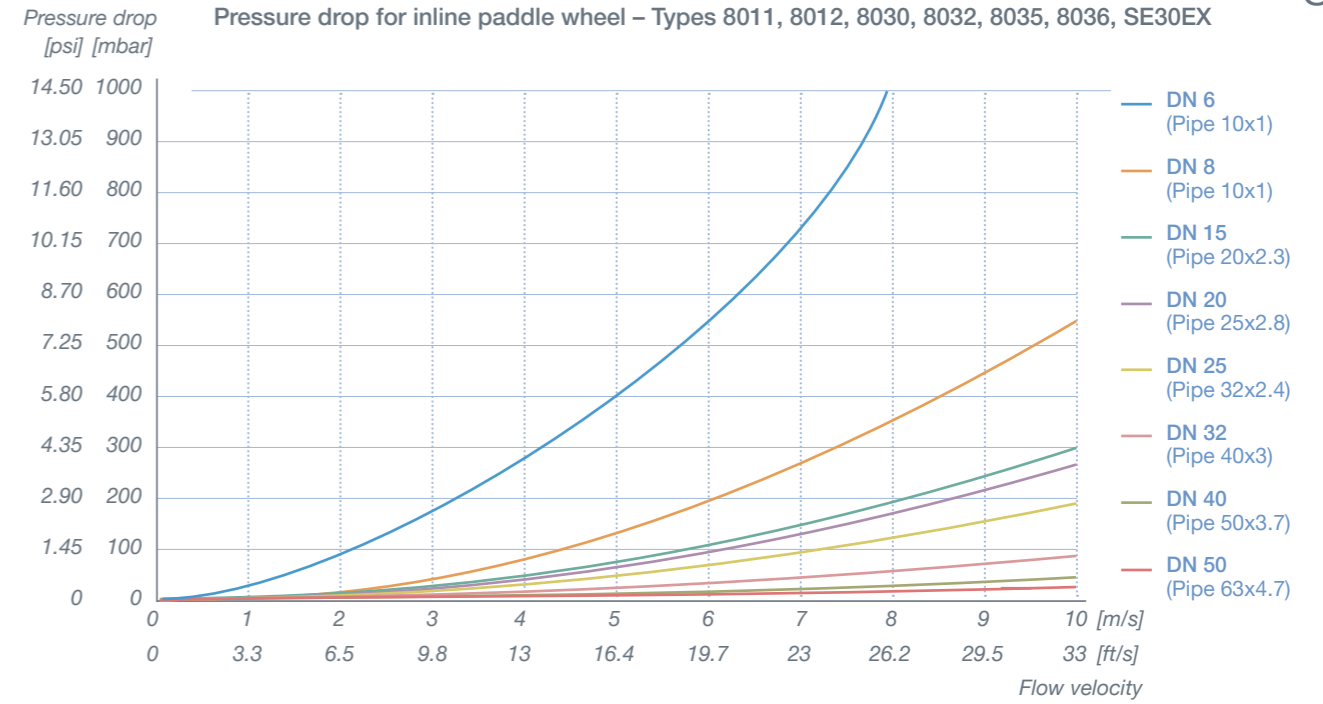

Modular Process Connections for Flow

Process connections for flow measuring instruments

Bürkert distinguishes between two fitting variants in relation to the installation of flow sensors in the process:

- Series S020 for insertion sensors
- Series S030 for inline sensors

Both fitting series feature a standard interface to the sensor modules, thus enabling very easy installation and fastening in the system. The special feature of inline sensors S030 in comparison with insertion sensors S020 lies in the fact that the electronic modules of the inline system can be exchanged with no leakage during operation of the process. The measuring sensor is located in the fitting and the measurement signal is transmitted without physical contact (magnetically or optically) to the electronic module. This means that the measuring sensor does not need to be directly connected to the electronics. On the insertion sensor, the measuring sensor is located in a finger which is immersed into the process. The sensor can be exchanged only after depressurizing the entire system in order to avoid leakage.

Insertion fitting system S020

When using Bürkert finger sensors, it is necessary to use Type S020 installation fittings of the correct nominal diameter. It is important to ensure that the correct finger length, dependent on nominal fitting diameter, is selected. We distinguish between a short sensor finger and a long sensor finger. Insertion series S020 fittings are available in plastic, brass or stainless steel. They consist of a connector with indentation, a plastic seal and a union nut for fixing the sensor in position. The connector is already permanently connected to a pipe fitting up to DN 50 (2"). A wide range of connection options for installation in a pipe are available (spigot, external thread, weld end, hygienic clamp or flange, etc.). In the case of nominal diameters from 65 to approx. 400 mm, it is advisable to use fusion spigots made of plastic, stainless steel, or a connection saddle made of plastic. Individual connectors which can be welded in (stainless steel) or screwed in (plastic) are recommended for installation in tanks.

DN 6 - DN 50 (¼"-2")	DN 50 - DN 350 (2"-14")
T-fitting with divers pipe connections made of stainless steel or plastic	Fusion spigot with or without radius made of stainless steel
	
DN 65 - DN 400 (2.5"-16")	DN 80 - DN 400 (3"-16")
Threaded connectors and fusion spigots made of plastic (weld-o-let)	Connection saddle made of plastic
	

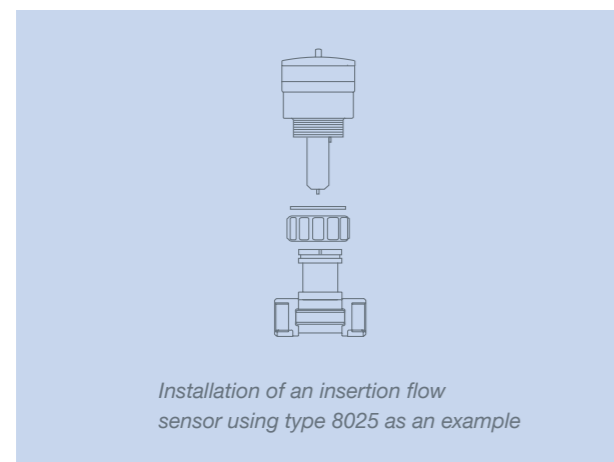





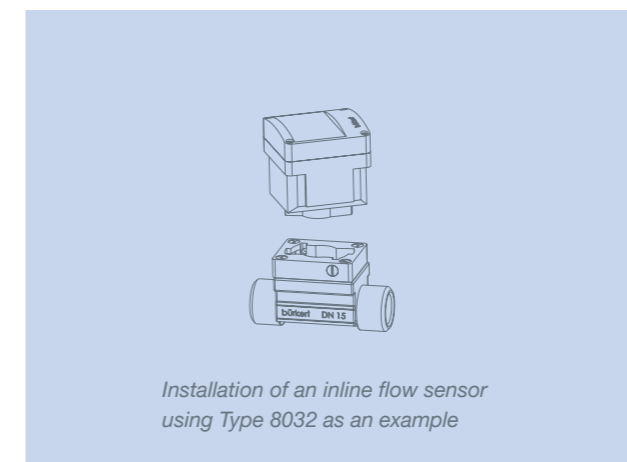

Inline fitting system S030 and S010

When using Bürkert inline sensors, it is necessary to use Type S030 installation fittings made of plastic, brass or stainless steel. In this series, the measuring sensor (a paddle wheel) is integrated in the fitting and is closed to the outside so that the system is not opened even if the electronic module is detached (no leakage). Signals are transmitted from the paddle wheel to the electronic module magnetically via an induction coil, Hall element or optically by means of infrared.

They consist of a pipe fitting with integrated measuring sensor (paddle wheel or magnetic paddle) and a screwed-on bayonet catch. The corresponding electronic module is inserted in this catch, rotated through 90° and locked with a screw. Series S030 fittings are available in the nominal diameter range from 6 to 50 mm with a variety of connection options for installation in a pipe (threaded port, external thread, weld end, clamp or flange, etc.) as are those in series S020. The Type S010 fitting is a special case since it features an integrated paddle – in place of the paddle wheel on the S030. A molded magnet in the paddle triggers a reed contact in the electronic module after being appropriately deflected by the flows dynamic force. The overall dimensions of the S010 are the same as those of the S030. Version S010 was developed for flow switch Type 8010. Inline series S030 or S010 fittings are available in plastic, brass or stainless steel.

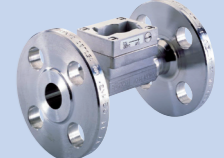

DN 6 - DN 50 (¼"-2")	
Plastic housing with true union connection with solvent or fusion spigot	Plastic housing with solvent joint or weld-end connection
	
Brass housing with internal thread (threaded port)	Stainless steel housing with weld end
	
Stainless steel housing with internal thread	Stainless steel housing with flanges
	
Stainless steel housing with clamp connection	Stainless steel housing with internal thread
	

Examples of S030 inline fittings

Pressure & Temperature Rating for Installed Inline and Insertion Flowmeters

Pressure/temperature diagram for plastics

The pressure resistance of plastics drops with increasing medium temperature. This dependence is shown for pressure stages PN10 and PN16 in the following diagrams.

Paddle wheel flow sensors

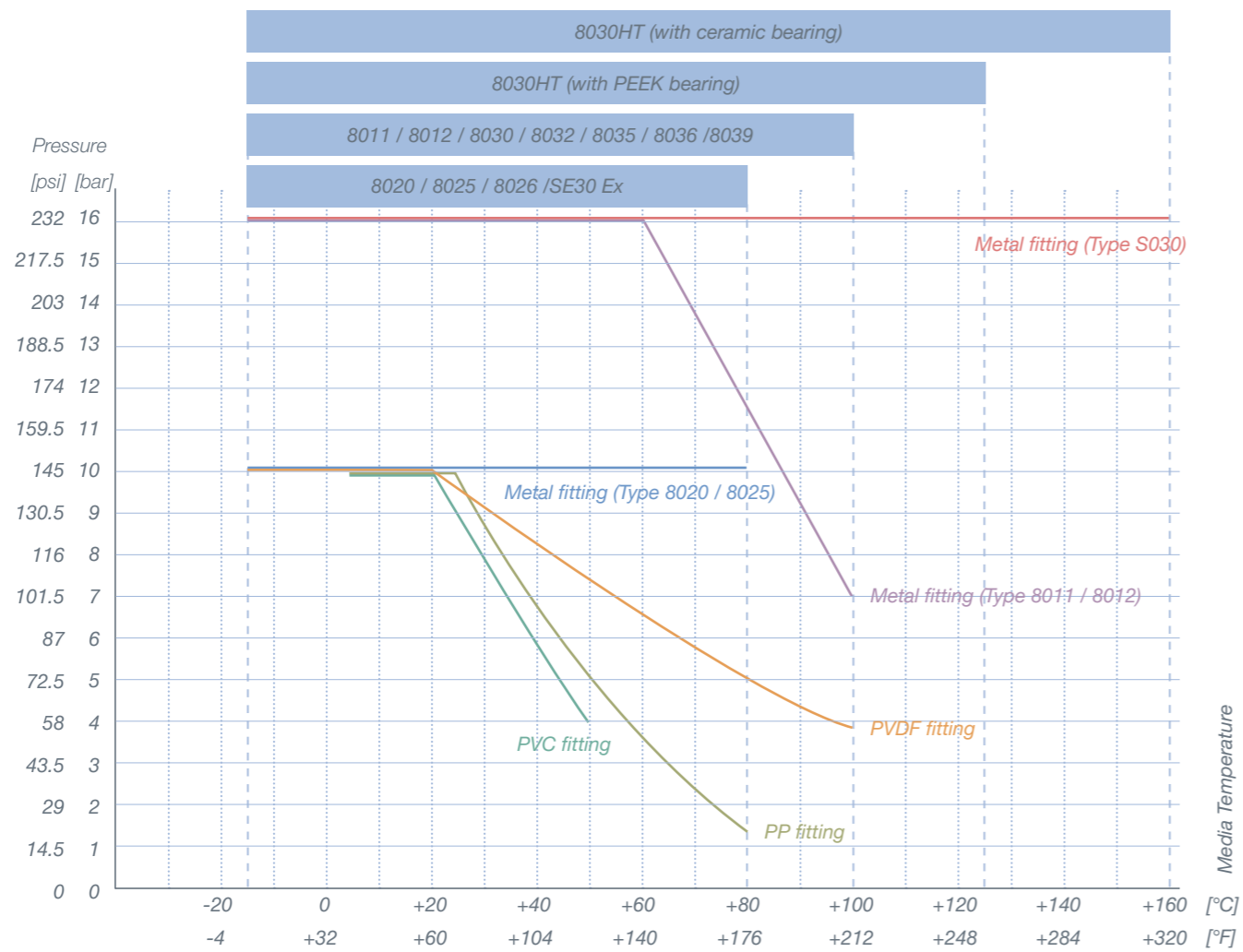

Insertion magmeter with PVDF finger

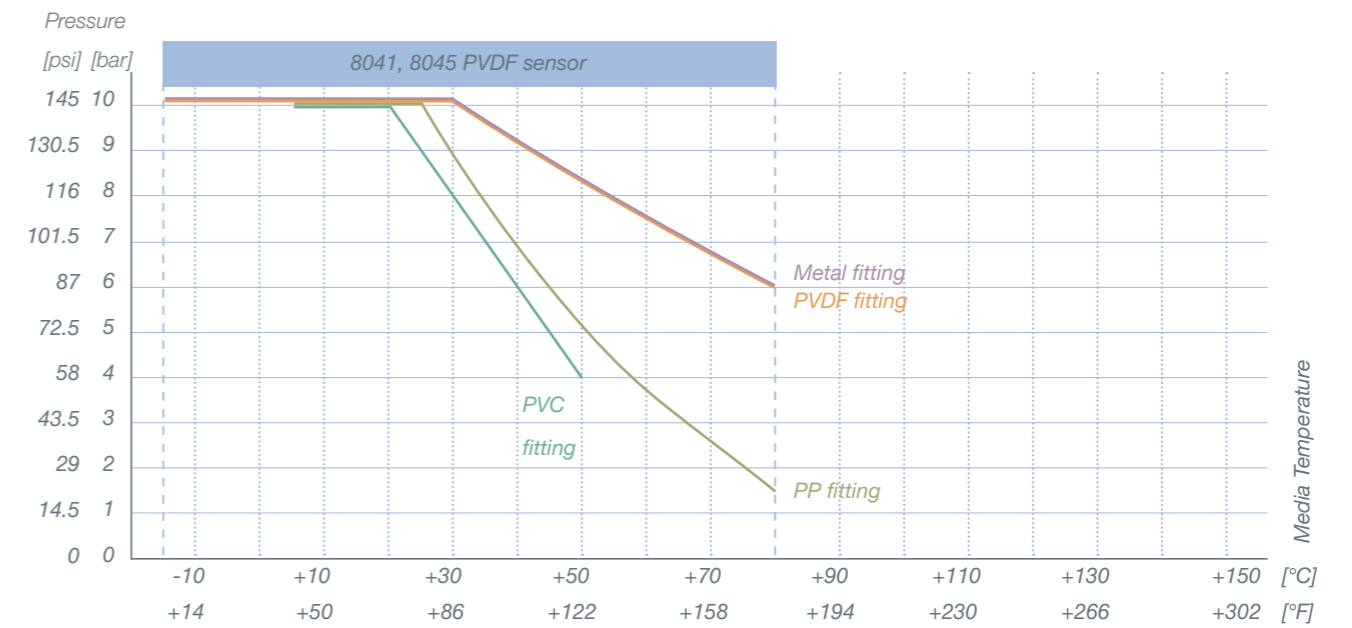

Insertion magmeter with stainless steel finger

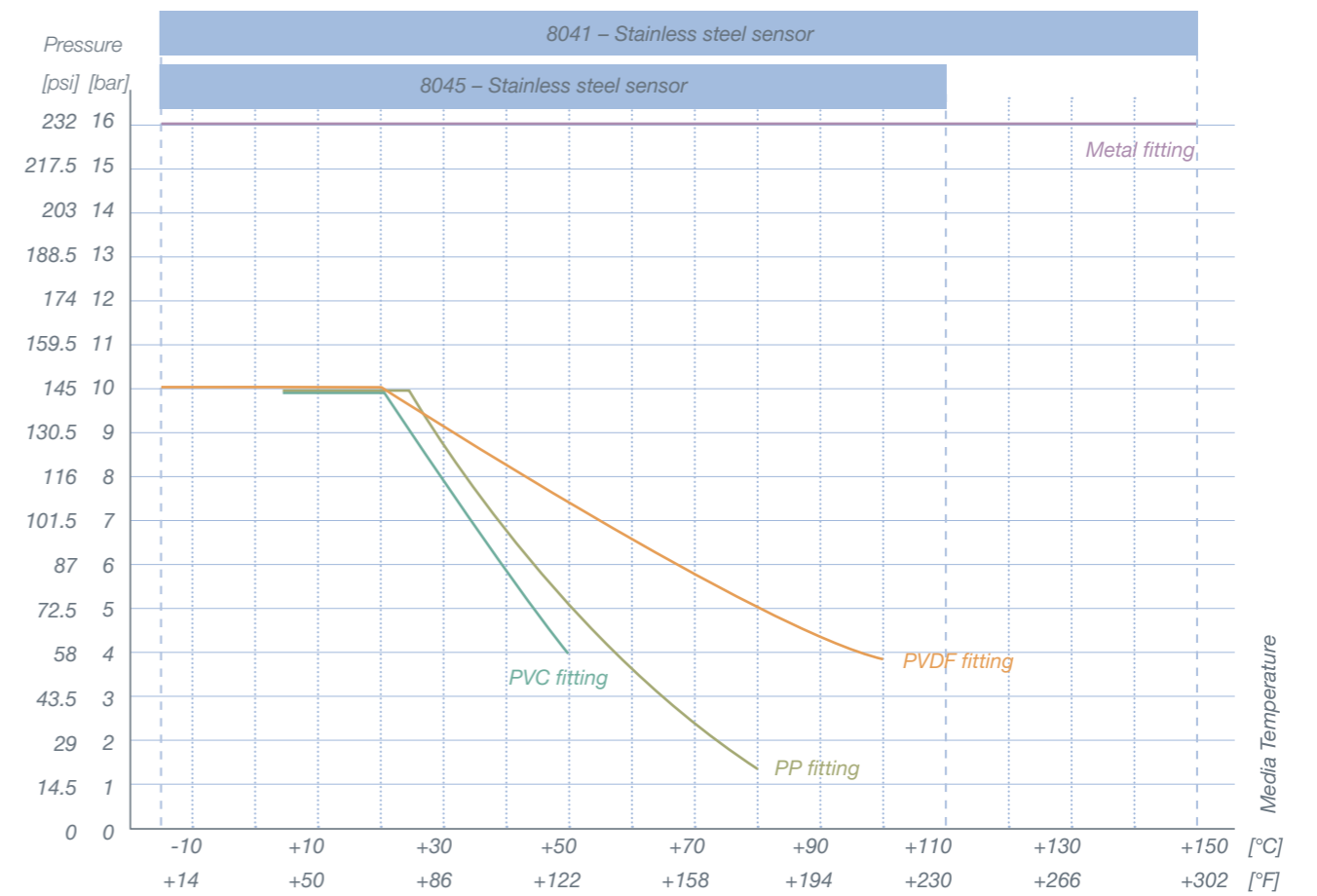

Our Level Best

Level measurement is an integral part of process control, and may be used in a wide variety of industries with many different requirements. We can divide level measurement into point level switching/alarming and continuous level monitoring/control.

Point level sensors are used to indicate the level has reached a single discrete liquid height which is a preset level. These sensors can be used to automate an on-off valve to fill liquid into a tank from a low to a high filling point in a tank. For point level we have supplied switches which employ these principles:

- Tuning fork
- Float

The more sophisticated continuous level sensors can provide complete level monitoring of a system. A continuous level sensor, as the name implies, measures the fluid level at all points within the measurement range, rather than at a specific, single point and carries out this task with or without contacting the media.

The continuous level sensor provides an analog output that directly correlates to the distance from the sensor position, the level in the tank and, with some programming, the volume. This analog signal from the sensor may be directly linked to a visual indicator or to a process control loop, forming a level management system.

Discrete sensors are often used in parallel to continuous sensors for overflow or leak positions (HH, LL). Exact level control is a key application for Bürkert as it involves a complete process loop and for continuous level we have supplied transmitters which employ these key principles:

- Ultrasonic
- Radar
- Guided microwave
- Hydrostatic

There is a level meter for every type of liquid in any shaped tank at any temperature. Application knowledge of both the sensor principles and the control loop is therefore the key to success. On the next few pages you will find descriptions of the operating principles behind our level world. Please take full advantage of our expertise by letting us help to design the installation and control the complete loop for you.

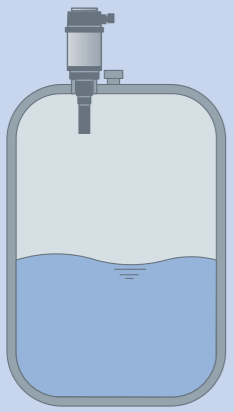
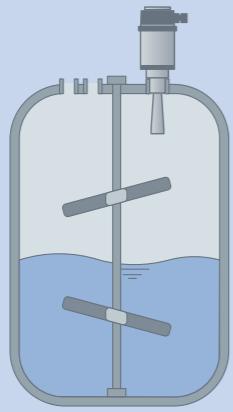
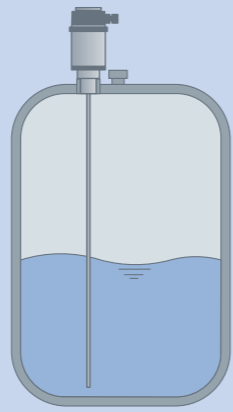

Level Measuring Principles

Ultrasonic	Radar	Guided Microwave
		
<p>The transducer of the ultrasonic sensor emits short ultrasonic pulses, at 70 kHz to the measured product. These pulses are reflected by the product surface and received by the transducer as echoes. The running time of the ultrasonic pulses from emission to reception is proportional to the distance and hence to the level. An integrated temperature sensor detects the temperature in the vessel and compensates the influence of temperature on the signal running time. The determined level is converted into an output signal and transmitted as a measured value. If the tank geometry is known, the volume still inside the tank can be indicated. Various disturbance echo filters even enable use in containers with built-in fixtures generating a disturbance echo.</p>	<p>The radar transmitter consists of an electronic housing, a process fitting element the antenna and a sensor. The antenna emits short radar pulses with a duration of approximate 1 ns to the measured product. These pulses are reflected by the product surface and received by the antenna as echoes. Radar waves travel at the speed of light. The running time of the radar pulses from emission to reception is proportional to the distance and hence to the level. The determined level is converted into an output signal and transmitted as a measured value.</p>	<p>High frequency microwave pulses are guided along a steel cable or a rod. When they reach the product surface, the microwave pulses are reflected and received by the processing electronics. The running time is valued by the instrument and output as distance. Time consuming adjustment with medium is not necessary. The instruments are preset to the ordered probe length. The shortenable rod versions can be adapted individually to the exact requirements.</p>

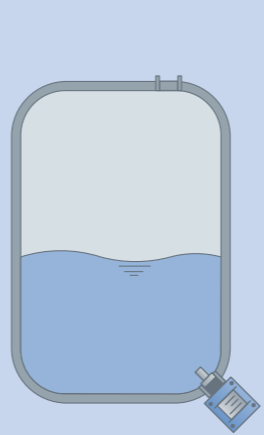
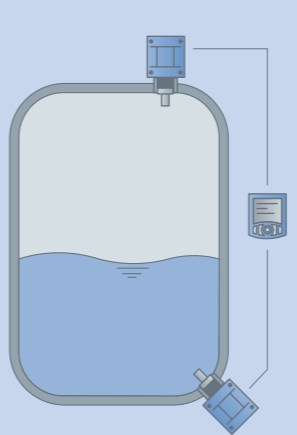
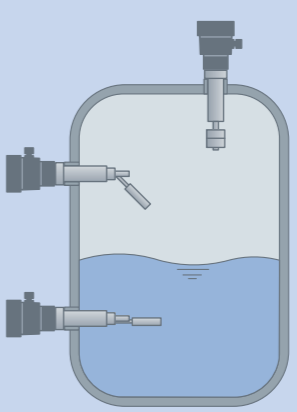
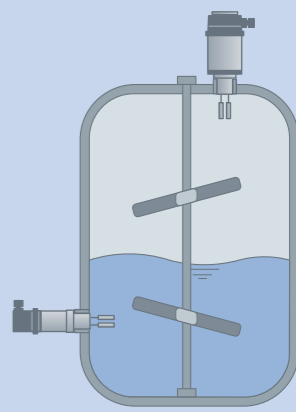
Hydrostatic	Hydrostatic DP	Float	Tuning fork
			
<p>A fluid column generates a specific hydrostatic pressure as a function of density and filling level. A pressure sensor attached to the bottom of a tank measures this pressure with respect to a reference pressure (generally ambient pressure). Conclusions are then drawn as to the filling level with the aid of the known fluid density. Hydrostatic level measurement is suitable for virtually all types of fluids and produces very precise measured values, dependent on the accuracy of the pressure transmitter.</p>	<p>Restrictions apply to applications in pressurized tanks. In such cases, it is then necessary to also measure this gauge pressure. This can be done by using a second pressure sensor which detects the pressure above the filling level.</p> <p>A corresponding evaluation unit corrects the measured value of the first pressure sensor on the tank bottom based on this value. The higher the internal pressure of the tank, the lower the share of hydrostatic pressure in the overall pressure, and the level measurement error increases. The measuring accuracy also drops further due to the use of two pressure sensors (addition of the measurement errors).</p>	<p>A float floating on a fluid changes its vertical position in proportion to the level. A permanent magnet integrated in the float generates a constant magnetic field, thus causing a reed contact in this field to switch. On a float switch, a float with magnet is mechanically connected to a reed contact.</p> <p>This allows a switching contact to be produced for a level. A mechanical stop on the float switch prevents the float rising if the fluid level continues to rise, so that the circuit state does not change. The float moves back out of the switch position only when the fluid level drops below this stop. Restrictions apply to the use of fluids with a low density (lower than 0.7 g/cm³) and coating fluids.</p>	<p>The tuning fork is piezoelectrically energized and vibrates at its mechanical resonance frequency of approx. 1200 Hz. When the tuning fork is submerged in the product, the frequency changes. This change is detected by the integrated oscillator and converted into a switching command. The integrated fault monitoring detects the following faults:</p> <ul style="list-style-type: none"> – interruption of the connection cable to the piezoelectric elements – extreme material wear on the tuning fork – break of the tuning fork – absence of vibration

Level Range

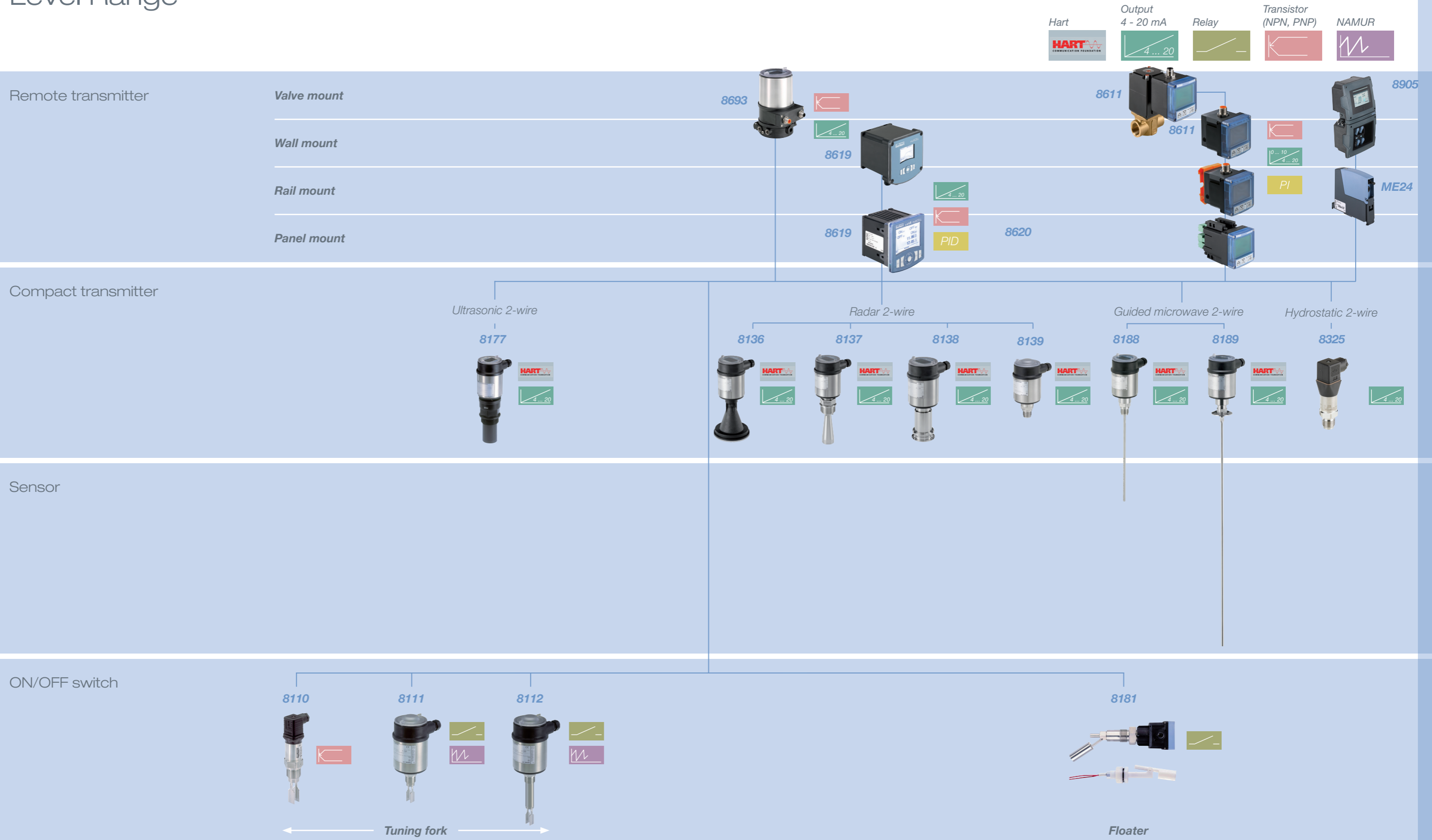

Level Switches – Features

Some versions offer approvals, see individual datasheets



Fluidic characteristics				
Sensor principle	Tuning fork	Tuning fork	Tuning fork	Floater
Vessel pressure	-1 – 64 bar	-1 – 64 bar	-1 – 64 bar	10 bar (SS), 1 bar (PP)
Process temperature	-40 – 150 °C (302 °F)	-50 – 150 °C (302 °F)	-50 – 150 °C (302 °F)	-40 – 120 °C (248 °F)
Wetted parts Seal Body	Klingsil SS	FKM SS	FKM SS	– SS or PP
Accuracy	2 mm	2 mm	2 mm	
Process connection	G or NPT 1", Clamp2"	G or NPT 1", Clamp2"	G or NPT 1", Clamp2"	G, Rc, NPT ¾"
Influence coating	Low	Low	Low	High
Influence steam / condensate	No	No	No	No
Avoid	Coating	Coating	Coating	Dust, coating
Electrical characteristics				
Basic function	Switch	Switch	Switch	Switch
Wiring	3-wire	3-wire	3-wire	3-wire
Output	Transistor PNP, contactless switch	Double-3 Amp- Relay, NAMUR	Double-3 Amp- Relay, NAMUR	Relay (3 Amp)
Display	LED	LED	LED	LED
Approval		ATEX	ATEX	



When the Pressure is On

Through our various applications we have assembled a range of pressure sensors which fit both within complete control loops and our customized system solutions.

From biotech to surface technology and from water treatment to the boiler room we cover the applications of our core customers with a complete range of pressure switches and transmitters designed with ruggedness, durability and accuracy in mind.

The measuring instruments output are a standardized 4-20mA or a voltage output and are easily installed, commissioned and calibrated.

Design and materials enable use in virtually all purities, viscosities and temperatures of fluids from ultrapure water to effluent and from molasses to helium in standard, hygienic or explosive environments.

Our diaphragm seals, supplied with relevant certification, protect our instruments from extremely aggressive, toxic, abrasive or high temperature fluids and are appreciated and recognized internationally for more difficult applications.

When integrated with our control valves and PID controllers we can control loops from the pressures associated with tank level measurement to hundreds of atmospheres. Our material selection and quality ensures control under pressure.



Pressure Measuring Principles

Pressure sensors are used for control and monitoring in thousands of everyday applications and are used to indirectly measure other variables such as fluid flow, speed and level. The pressure transducer translates the mechanical effect of force per unit area by generating a signal as a function of the pressure imposed. This signal, when conditioned and amplified becomes a standard industrial signal such as 4-20mA or 0-10VDC.

The basic transducer is made from a strain gauge which makes use of the changes in resistance that some materials experience due to change in its stretch or strain. Making use of the change in conductivity of material when experiencing different pressures sounds simple but when zero, span, miniaturization, linearity, temperature and durability are essential there can be no corners cut. Strain gauge type sensors can vary drastically in technology, design, performance, application suitability and cost.

From the many technologies available we have produced a range of gauge and absolute pressure instruments with accuracies to 0.1% which fit our global customers' requirements from gas handling to steam technologies. Our principles mean that we deliver stable, reliable instruments and control loops to quickly meet your project demands with certificates of calibration and traceability.

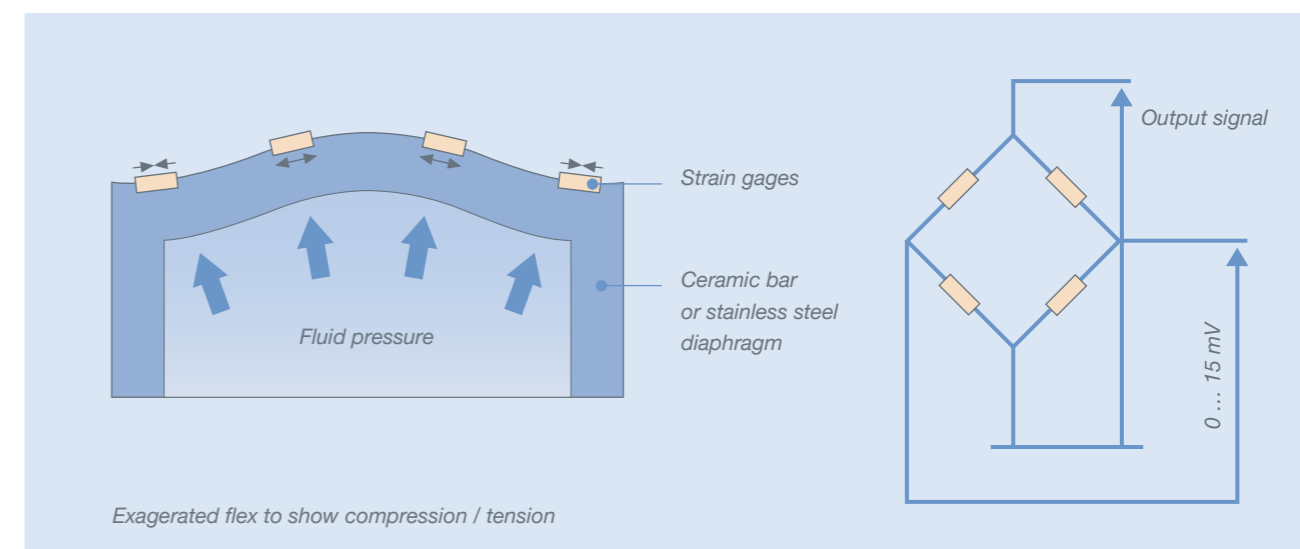

Explanatory information on measuring range turn-down

Certain pressure measuring instruments allow the nominal pressure measuring range to be turned down to 1/20 (e. g., a nominal range of 0 - 10 bar can be reduced to 0 - 0.5 bar). The accuracy decreases as the turndown factor increases. The following applies as a general rule:

- Turn down $\leq 1/5$: No change in accuracy
- Turn down $> 1/5$: New accuracy = nominal accuracy x (turn-down factor / 5)
(e. g., turn-down 1/20, nominal accuracy 0.15 %, new accuracy = $0.15 \times 20/5 = 0.6 \%$)

Measuring range turn-down

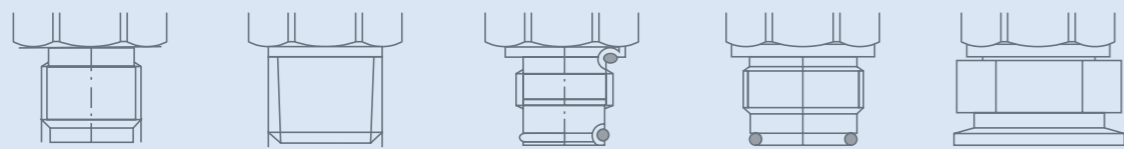
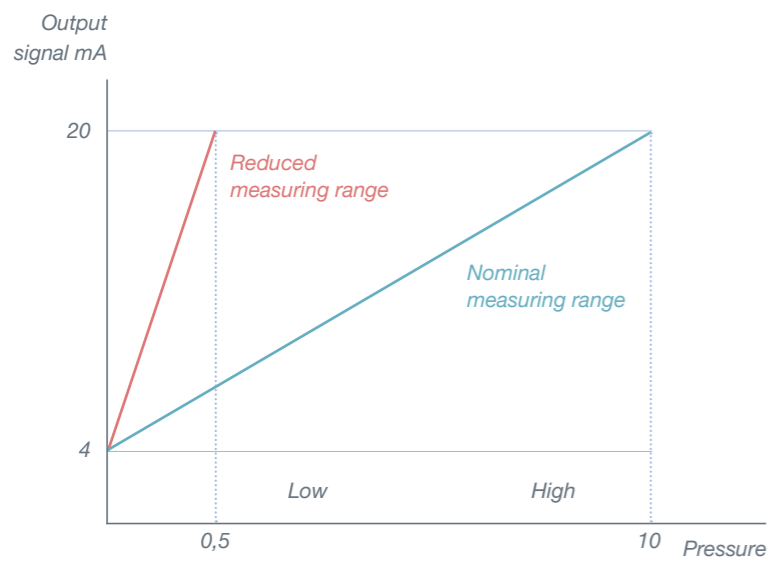

Multiple process connections: G, NPT, flush, EHEDG, clamp

Pressure Range

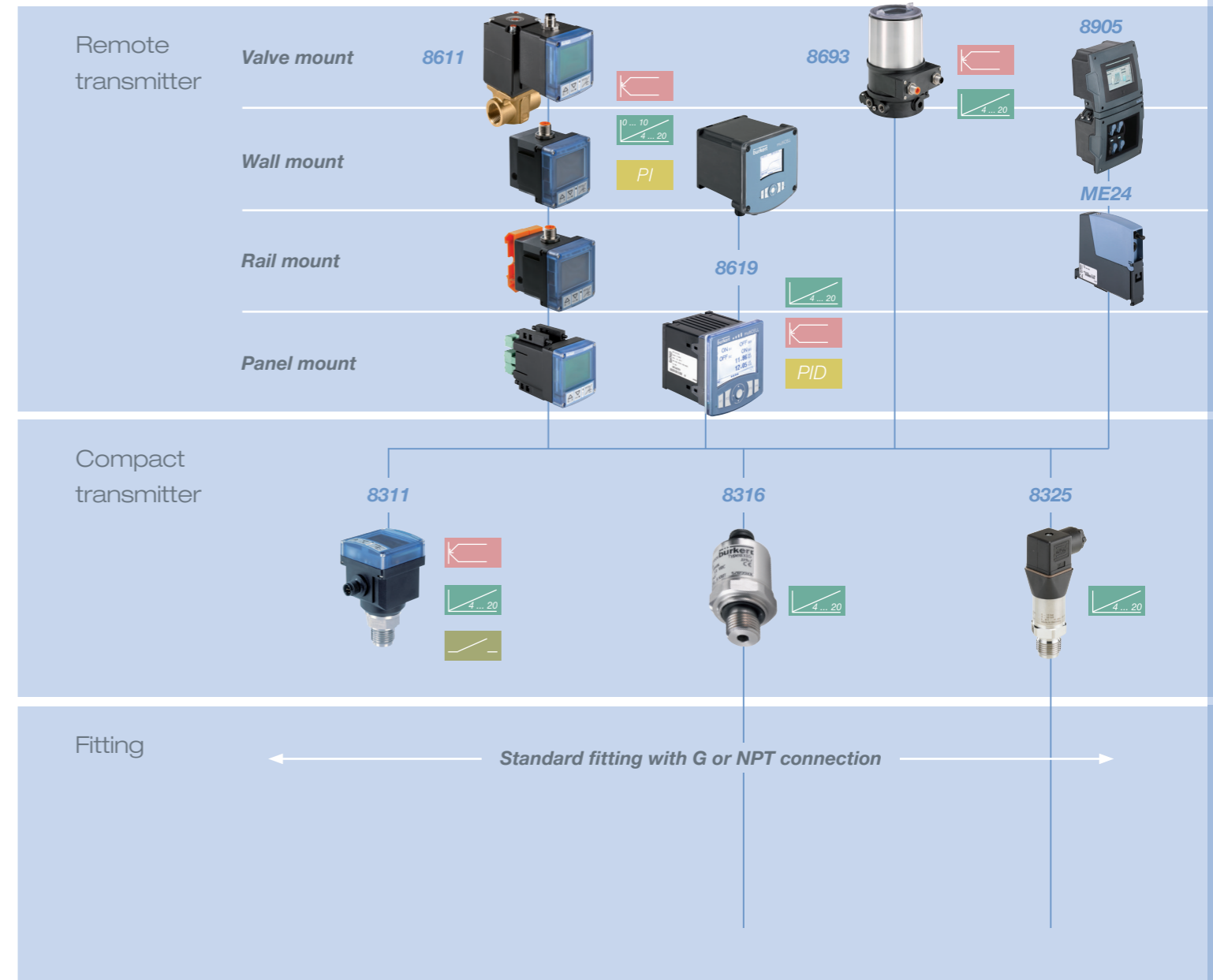

Pressure Features

Some versions offer approvals, see individual datasheets



Fluidic characteristics				
	Measuring range	0 to 50 bar (725psi)	0 to 100 bar (1,450psi)	0 to 25 bar (362psi)
	Measuring principle	Ceramic measuring cell	Ceramic/thick film measuring cell	Thin filmstr. gauge piezoresistive
	Materials coming into contact with media	Stainless steel, FPM, EPDM (option)	Ceramics (Al 2O3), stainless steel 1.4305, FKM seal	Stainless steel, FKM, EPD
	Accuracy	1 % full scale	0.5 % full scale	0.5 full scale
	Process connection	G, NPT, RC	G, NPT, DIN 3852-E	G, NPT, DIN 3852-E
Fluid properties	Max. medium temperature	100 °C (212°F)	-15 to + 125 °C (5 to 257°F)	-30 to 100 °C (212°F); higher on request
	Clean	●	●	●
	Contaminated	With flush diaphragm		With flush diaphragm
	Hygiene	With flush diaphragm		With flush diaphragm
Electric characteristics				
Basic function	Switch	●		
	Transmitter	●	●	●
	Transmitter in accordance with ATEX			
Output	Transistor (max. 0.7 mA/80 V DC)	●		
	Relay (max. 3 A/250 V A G)	●		
	4 - 20 mA	●	●	●
	Digital communication			
Supply voltage	10 - 30 V DC	●	●	●
Equipment features	Display	●		
	Keypad	●		
	Bargraph	●		
	Teach-In calibration	●		
	Simulation	●		
	Hysteresis mode	●		
	Window mode	●		
Design	Compact device	●	●	●
Expansibility	Stand alone	●	●	●
	With Bürkert remote electronics		●	●
	To PLC or other external electronics	●	●	●

Hot Ideas and Cool Solutions

Temperature is often cited as the most commonly controlled process variable and it is certainly everyday business for us to help our customers achieve success in their temperature control loops in either heating or cooling systems.

The heat exchange process always relies on accurate temperature monitoring, switching and control. We have integrated thousands of temperature control solutions in factories and on process skids around the world and we understand the intricacies of achieving optimum results.

Our range of temperature sensors, switches and transmitters is configured to provide you peace of mind. As we need to offer long term durability and reliability. The basis for all our temperature measurements is the Pt100 sensor. Stainless steel design enable application in virtually all purities, viscosities and pressures of fluids from simple recycled cooling water to burner gases.

When integrated with our control valves and PID controllers we produce perfect, fast response temperature loops. Inherent modularity ensure you can choose a sensor, a transmitter, a thermowell, a display or a complete control system to meet your most demanding application.

Whether you are cooling an injection molding process or pasteurizing orange juice we can help you realize a hot idea or produce a cool solution.



Temperature Measuring Principles

Resistance temperature sensors (Pt100 technology) is proven in providing the durability necessary in the industrial processes where Bürkert helps its customers. While thermocouples use the Seebeck effect to generate a voltage, resistance thermometers use electrical resistance and require a power source to operate. Resistance thermometry utilizes the temperature dependence of the electrical resistance of metals. The electrical resistance of metals increases with growing temperature. This Positive Temperature Coefficient (PTC) is well understood in platinum which is why the Pt100 is the basis for our measurements.

In order to measure the resistance of the sensor, the voltage drop across the sensor is measured while a current of 1mA flows through the circuit. This simple two-wire circuit also measures the electrical resistance of the cables and therefore three-wire circuits are normally employed in industrial environments to eliminate this error. Platinum offers high chemical resistance, good reproducibility of the electrical properties and simple processing. The nominal value of a Pt100 sensor is 100 Ω at 0 °C. This raw resistance measurement can be routed right to one of our PID enabled control valves or can be amplified to produce a standard 4-20mA signal or can be used to switch a relay or through hardware onto a fieldbus.

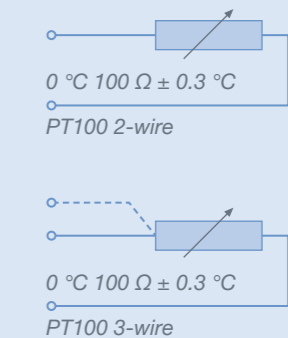
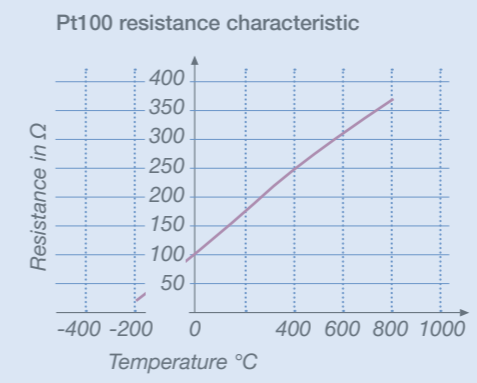
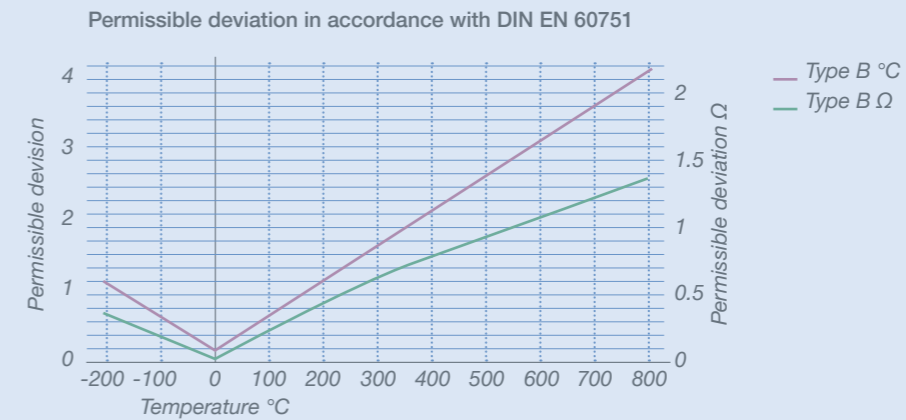

Temperature Range

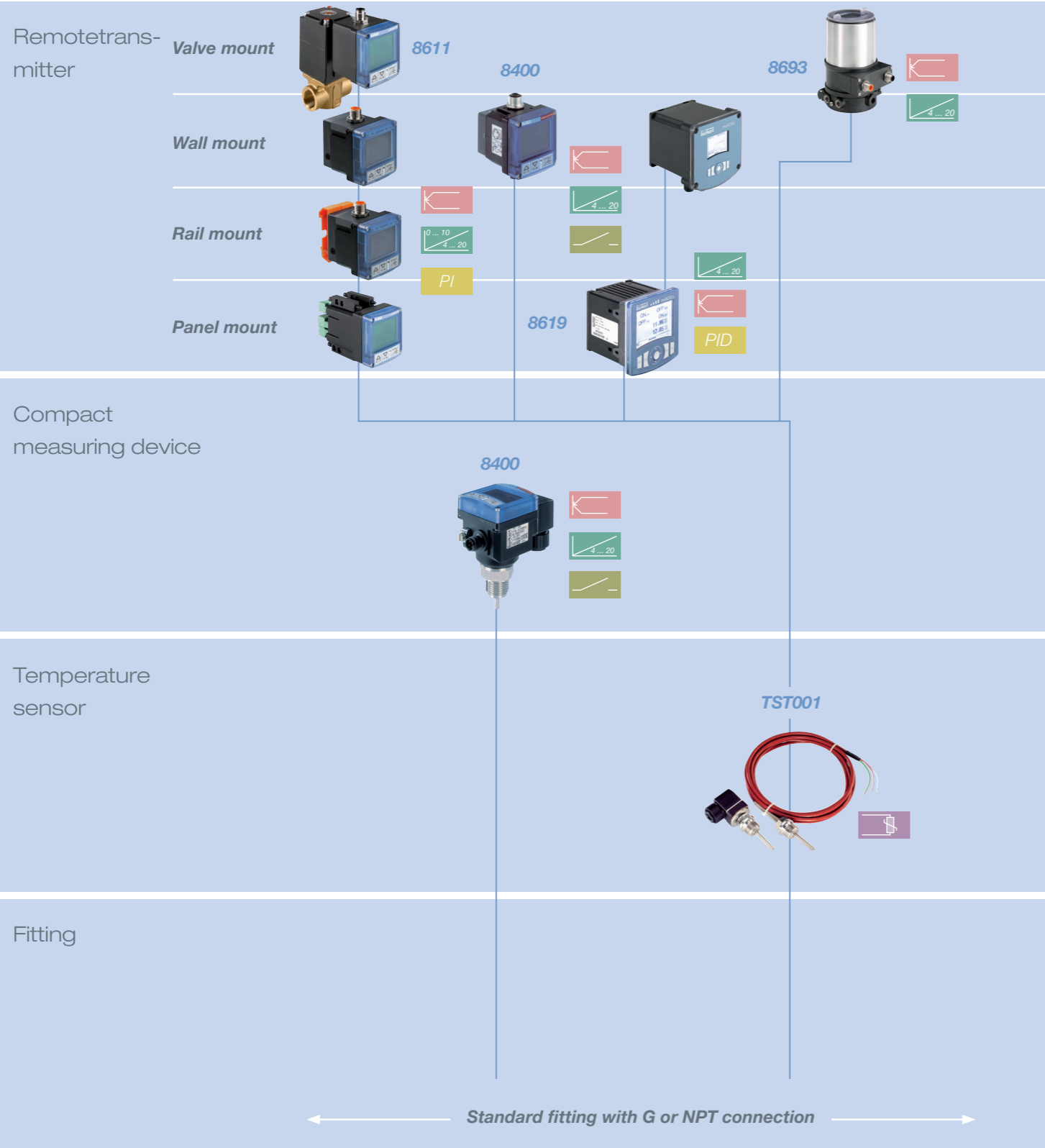

Temperature Features

Some versions offer approvals, see individual datasheets



		Type 8400	TST001
Fluidic characteristics			
	Measuring range	-40 to +125 °C (257°F)	max. 200 °C (392°F)
	Measuring principle	Pt 100	Pt 100
Sensor material	Stainless steel	PN 16	PN 16
	Brass	PN 16	
Fluid properties	Clean	•	•
	Contaminated	•	•
Electric characteristics			
Basic function	Switch	•	
	Sensor		•
	Transmitter	•	
Output	Transistor	•	
	Relay (max. 3 A/250 V A G)	•	
	4 - 20 mA	•	
	AS-i-Bus	•	
	Resistance		•
Supply voltage	None		
	10 - 30 V DC	•	
Equipment features	Display	•	
	Keypad	•	
	Teach-In calibration	•	
	Simulation	•	
	Hysteresis mode	•	
	Window mode	•	
Design	Compact device	•	•
	Control panel installation	•	
	Field device	•	•

pH and ORP ... Analyse Your World

Water quality is often determined by these important transmitters and is essential in applications like boiler water conditioning, cooling towers, swimming pools or reverse osmosis.

Analytical expertise combined with our valve history in engineered plastics has made perfect added functionality for simple, accurate pH control for solutions in tanks or inline.

Our production facility in Triembach, France takes pride in designing and manufacturing both pH/ORP transmitters and fully functional pH controllers for a continually expanding global client list.

Each pH sensor fits perfectly inside our analytical range and exhibits common interfaces and communication structures which are characterized by similar menus, displays, voltages, and calibration functions.

Factory calibration certificates are always available and materials such as enamel, PVDF, FKM, EPDM and stainless steel are used to ensure long life and chemical compatibility while a wide assortment of electrodes allows deployment into virtually all types of fluids.



pH/ORP – Measuring Principles

pH measurement with glass electrode

The hydrogen ion concentration (pondus hydrogenii or pH value) in an aqueous solution generates a potential difference at a measuring electrode, pH-sensitive glass diaphragm, with respect to a reference electrode (Ag/AgCl). This voltage is measured by a high-impedance pH measuring instrument and converted to a pH value. The relationship between pH value and voltage is linear, with a slope of 59.16 mV/pH. The slope is temperature-dependent and is compensated by an integrated temperature sensor. Bürkert pH measuring instruments can be used in virtually all fluids on which pH measurement is required, depending on the selection of electrodes. The option of selecting between a compact device with display or a remote version with remote display ensures that the optimum solution is available for virtually any application.

pH measurement with enamel electrode

The 8201 pH sensor works as a single-rod measuring cell. The measuring electrode and reference electrode are combined in one element. An enameled steel pipe is used as the basic carrier. The measuring electrode is created by attaching an ion-sensitive enamel layer (yellow) with metallic voltage conductor (metal ring, positioned in the non-conductive blue enamel carrier layer). An ion exchange of H^+ ions and Na^+ ions takes place on the surface (gel layer) of this enamel layer. The Ag/AgCl reference electrode is located in the interior of the enamel pipe filled with electrolyte. A ground ceramic diaphragm is pressed into the lower end of the pipe. Voltage transfer takes place when the electrolyte makes contact with the measuring solution via the annular gap of the ground diaphragm. A Pt1000 for temperature compensation is also integrated in the sensor. The electrolyte used is 3-molar KCl, stored in a separate electrolyte vessel and permanently connected to the electrode via a small tube. The pressure of the electrolyte vessel is maintained slightly above process pressure.

pH Measurement with ISFET MEMS

The Sensor Cube MS01 is designed for use within a Type 8905 Online Analysis System. The pH measurement – the sensor – itself is based on a new technology. The gate of a field effect transistor is in contact with the sample water. The gate of the ISFET (ion selective field effect transistor) is H^+ sensitive due to the specific semiconductor material. So the concentration of H^+ at the gate causes more or less source drain current. The sensor is built onto a MEMS (micro electronic and mechanical system) which is designed into a housing which fits to the Bürkert platform of fluidic backplanes and the communication and device platform EDIP. Within the small Sensor Cube there is the sensor MEMS, the transmitter and a processor including memory for all settings like calibration data. The communication is digital and so the corresponding reading of pH-value, temperature, messages and limit warnings and so on are transmitted to any data consumer within the connected system.

ORP measurement

The oxidation-reduction potential electrode measures the potential of a solution on the basis of the presence of specific ions (e. g., Cl^- or O_3). It is the tendency of a chemical species to gain or lose electrons at a noble metal electrode. This potential occurs between a metallic measuring electrode (platinum or gold) and a reference electrode (Ag/AgCl). ORP is usually measured in millivolts. It provides information on the oxidizing or reducing capability of the solution. Similar to pH measuring instruments, the same devices can be selected due to the similarities of the +/- 2000mV used for both the compact version and remote transmitters and controllers.

There is also a Sensor Cube Type MS03 for ORP measurement available – also designed for use within a Type 8905 Online Analysis System. The sensor is based on MEMS technology but the measure method equals the described method.

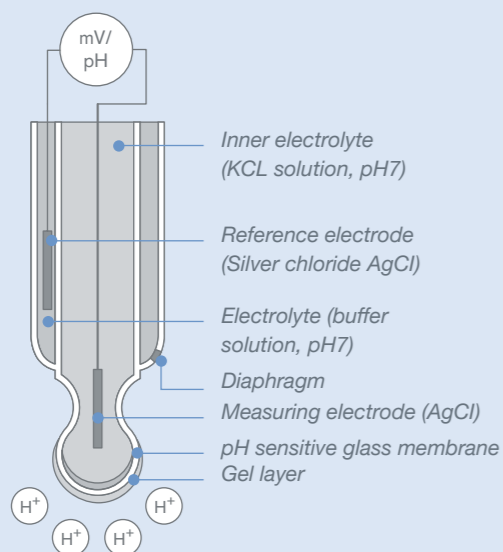

Principle of pH-measuring with glass electrode

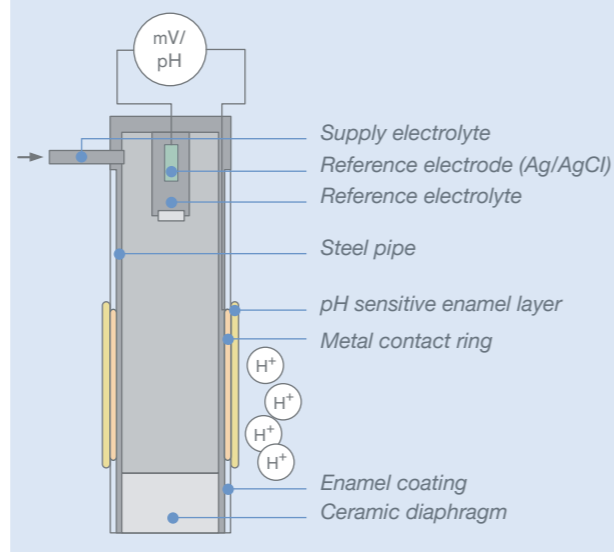

Principle of pH-measuring with enamel electrode

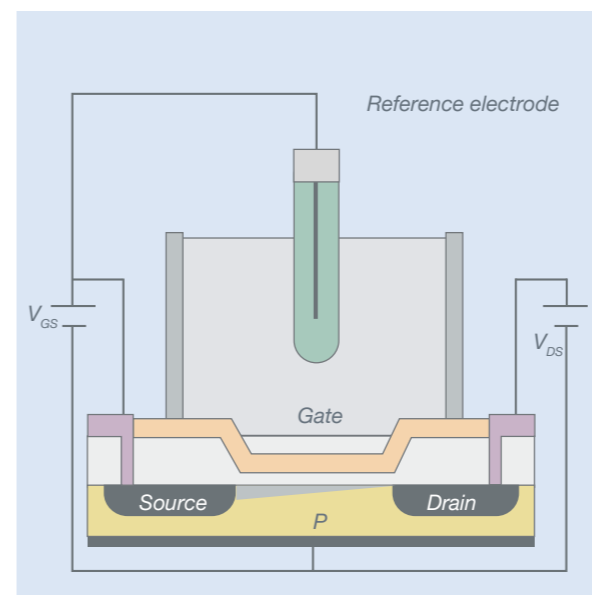

Principle of pH-measuring with ISFET

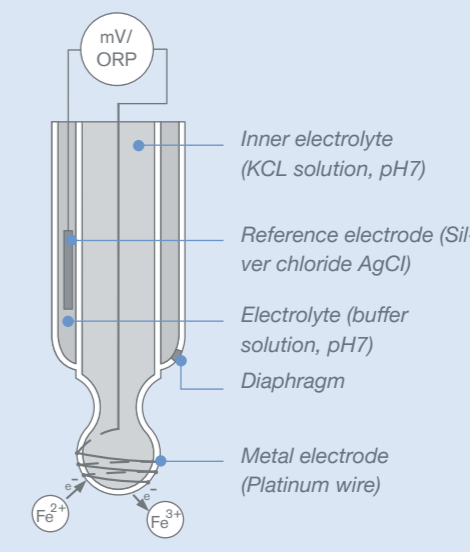

Principle of ORP-measuring

Temperature compensation

The pH of a solution is a function of temperature. If the temperature changes, so does the pH, even though the concentration of the acid or base causing the pH remains constant. With temperature, the sensitivity (voltage change per pH unit) changes. Temperature compensation is a way of converting the pH at the measurement temperature to the pH at a reference temperature. The reference temperature is almost always 25°C (77°F). For example:

- Slope at 25°C (77°F): 59.16 mV/pH
- Slope at 100°C (212°F): 74.04 mV/pH
- This dependence is permanently compensated with the integrated temperature probe, thus the values are always comparable.





Calibration

Electrodes cannot be produced with exactly identical characteristics. Offset and slope will vary with time and manufacturer that produce electrodes with different nominal values. The calibration matches the pH meter to the current characteristics of the electrodes. For this purpose a solution with a precisely known pH has to be used. The calibration process is generally performed by measuring in two different buffer solutions. This enables both offset and slope to be determined. Basically three possibilities of calibration procedures are possible:

- One-point calibration (only the pH equivalent to the buffer solution is known) offset and slope can not necessarily be determined unless a buffer solution of seven is used.
- Product calibration (calibration with sampling)
- Two-point (offset and slope can be detected)



pH/ORP Range

PID Controller	Alarm Relay	Output 4 - 20 mA	Relay switch	Transistor
				

Remote transmitter

Wall mount



Rail mount

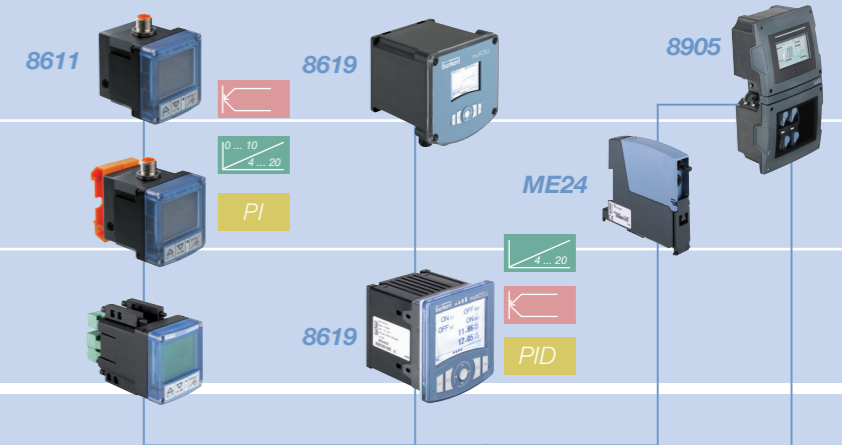

Panel mount



Compact meter



Sensor

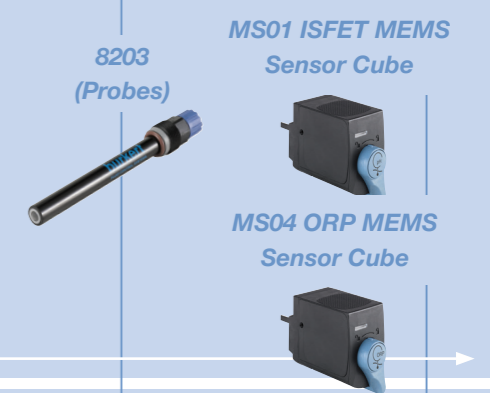
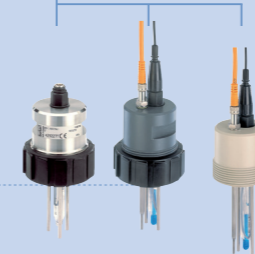
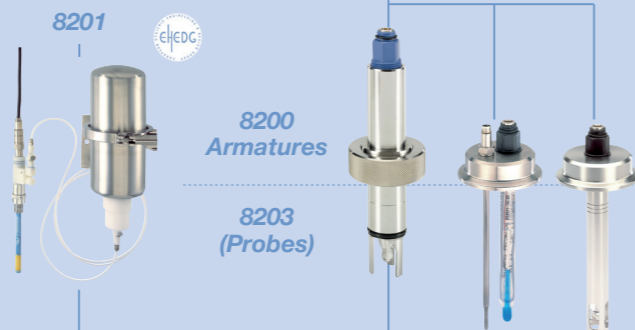

Fitting



Fittings with standardized hygienic process connections

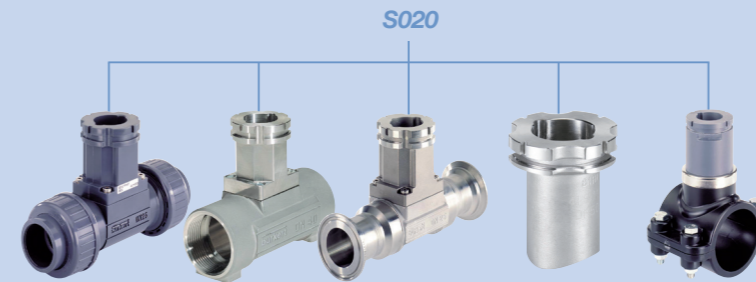

Insertion fittings



Insertion adapter

← pH/ORP →

pH/ORP Features

Some versions offer approvals, see individual datasheets



Fluidic characteristics					
	Type 8200 Holder and 8203 pH/ORP probe	Type 8201 Glass-free pH probe	Type 8202-pH/ORP meter	Type MS01 ISFET MEMS Sensor Cube	Type MS04 ORP MEMS Sensor Cube
Measuring range	pH 0 – 14 ORP -2,000 ... +2,000 mV	0 – 12 pH	- 2 to 16 pH; -2,000 ... +2,000 mV ORP	pH 4... pH 9	-2,000 ... +2,000 mV
Fluid pressure in bar	Depends on probe and fitting Up to 16 bar	Vacuum 6 bar	Max 16 bar; depends on mounted probe and fitting (See P/T chart pages 110/111)	PN3; min. 0,5 bar	PN3; min. 0,5 bar
Fluid temperature in °C	Depends on probe and fitting Up to 130°C	0 – 140°C (284°F)	Max 130°C; depends on mounted probe and fitting (See P/T chart pages 110/111)	+3...+40°C (+37...+104°F)	+3...+40°C (+37...+104°F)
Material of wetted parts	Sensor Seal Body	Enamel, ceramic EPDM Stainless steel	PVDF 1), SS FKM or EPDM 1) PVDF 1)	PPE+PS / PC / EPDM	PPE+PS / PC / EPDM
Temperature compensation	Pt 1000	Pt 1000	Automatic with Pt 1000	Automatic with Pt 1000	n/a
Process connection	G 2" (S020), G 1" (thread), hygienic thread G1 1/2"; Clamp 1 1/2"; 2" (DN50/40) connection adapted for GEA Tuchenhagen VARINLINE process connections	Various hygienic clamps, Ingold	G 1 ½" (S022)	EDIP fluidic backplane Type BEF1	EDIP fluidic backplane Type BEF1
Fitting type	S020	8201	S022	EDIP fluidic backplane Type BEF1	EDIP fluidic backplane Type BEF1
Electrical characteristics					
Basic function	Sensor	Sensor	Transmitter, Switch	Sensor, Transmitter, digital communication acc. EDIP standard	Sensor, Transmitter, digital communication acc. EDIP standard
Output signal	Analogue raw signal	Analogue raw signal	Up to 2x 4 – 20 mA, up to 2x Digital out (Transistor)	büS / CANopen	büS / CANopen
Output value	n/a	n/a	pH or ORP (convertible) and temperature	All internal data incl. pH value, temperatures, internal voltages and currents acc. to EDIP standard	All internal data incl. ORP value, temperatures, internal voltages and currents acc. to EDIP standard
Display	No	No	Yes, removable	No	No
Compatible transmitters	Type 8619	Type 8619	Integrated	n/a	n/a
Specifics	Special CIP/SIP compatible variant available	CIP-compatible, inline sterilizable (SIP), EHEDG available	CIP-compatible; Usage of standard pH/ORP probes Type 8203	Configurable with Bürkert Communicator Type 8920	Configurable with Bürkert Communicator Type 8920

1) Wetted polymers in accordance to FDA; declaration of conformance available

pH/ORP Probes – Selection Help



Electrode	Logotrode pH 120	Unitrode plus pH 120	Ceratrode pH 120	Plastrode pH 120	Flatrode pH 120	Fermtrode pH 120	Enamel Electrode 8201	Logotrode ORP 120	Unitrode ORP 120	Flatrode ORP
Fluids	Clean <ul style="list-style-type: none"> • drinking water • cooling water • aquarium • swimming-pool 	Contaminated <ul style="list-style-type: none"> • effluent rinse water • cooling water • electro-plating • paints • cosmetics Containing sulfides / proteins <ul style="list-style-type: none"> • tannery • animal breeding • effluent • foodstuff • cosmetics • biotechnology 	High pressure, high flow rate applications	Basic probe for drinking water, aquarium, swimming-pool	Contaminated <ul style="list-style-type: none"> • viscous • suspended solids • small sized solids • paints • cosmetics • foodstuff 	Biotechnology, pharma, food industry containing proteins, cell cultures, injectable applications requiring biocompatibility or suitability for food contact guarantee	Inline measuring in food and beverage applications CIP – In process CIP cleaning SIP – In process steam sterilizing	Clean <ul style="list-style-type: none"> • cooling water • waste water or slightly contaminated 	Clean <ul style="list-style-type: none"> • drinking water • aquarium • swimming-pool Contaminated <ul style="list-style-type: none"> • effluent rinse water • cooling water • electro-plating • paints Containing sulfides / proteins <ul style="list-style-type: none"> • tannery • animal breeding • effluent • foodstuff • cosmetics • biotechnology 	Contaminated <ul style="list-style-type: none"> • viscous • suspended solids • small sized solids • paints • cosmetics • foodstuff
Measuring range	0 ... 14 pH	0 ... 14 pH	0 ... 14 pH	0 ... 14 pH	0 ... 14 pH	0–14 pH	0 - 12 pH	-2,000 ... +2,000 mV	-2,000 ... +2,000 mV	-2,000 ... +2,000 mV
Fluid pressure	0 - 6 bar (87psi)	0 - 16 bar (87psi)	0 - 16 bar (232 psi)	0 - 6 bar (87psi)	0 - 6 bar (87psi)	0–6 bar (87 psi)	0 - 6 bar (87psi)	0 - 6 bar (87psi)	0 - 16 bar	0 - 6 bar (87psi)
Fluid temperature	-10 to +60 °C (140°F)	0 to +130 °C (266°F)	0 to +130 °C (266°F)	-10 to +40 °C (104°F)	-10 to +80 °C (104°F)	0 to +140 °C (284°F)	0 to +140 °C (284°F)	-10 to +60 ° (122°F)	0 to +130 °C (266°F)	0 to +80 °C (104°F)
Ambient temperature	Operation	0 to +60 °C (140°F)	0 to +60 °C (140°F)	0 to +60 °C (140°F)	0 to +60 °C (140°F)	0 to 60 °C (140 °F)	0 to + 50 °C (122°F)	0 to +60 °C (140°F)	0 to +60 °C (140°F)	0 to +60 °C (140°F)
	Storage	+4 to +30 °C (86°F)	+4 to +30 °C (86°F)	+4 to +30 °C (86°F)	+4 to +30 °C (86°F)	+4 to 30 °C (86 °F)	–	+4 to +30 °C (86°F)	+4 to +30 °C (86°F)	+4 to +30 °C (86°F)
Minimal conductivity	2 µS/cm	2 µS/cm	50 µS/cm	50 µS/cm	50 µS/cm	100 µS/cm	2 µS/cm	2 µS/cm	2 µS/cm	50 µS/cm
Max. pressure at max. temperature	6 bar at +60°C See P/T chart p. 110/111	10 bar at +130°C See P/T chart p. 110/111	6 bar at +130°C See P/T chart p. 110/111	6 bar at +40°C See P/T chart p. 110/111	4 bar at +80°C See P/T chart p. 110/111	6 bar to 80 °C	6 bar at 140°C	6 bar at +60°C See P/T chart p. 110/111	6 bar at +130°C See P/T chart p. 110/111	4 bar at +80°C See P/T chart p. 110/111
No. of diaphragms	1	2	3	1	1	1	1	1	2	1
Diaphragms	“single pore™”	“single pore™”	HP ceramics	“single pore™”	Annular and centered, in High Density Polyethylen	HP-COATRATIC	Ceramic diaphragm	“single pore™”	“single pore™”	Annular and centered, in HDPE
Reference electrolyte	Polymer	Polymer	Gel	Polymer	Acrylamide gel KNO3/3.5M KCl-AgCl	Pressurized “FOODLYTE™”	Liquid (3 mol KCL)	Polymer	Polymer	Acrylamide gel KNO3/3.5M KCl-AgCl
Compatible with	8202, 8619	8202, 8619	8202, 8619	8202, 8619	8202, 8619	8619	8619	8202, 8619	8202, 8619	8202, 8619
Comment						Integrated PT100	Integrated PT1000 glass-free design, EHEDG			

Conductivity

Conductivity tells us the amount of dissolved solids there is in a solution and is one of the most important and common analytical measurements in the process environment.

Its applications range from determining the quality of baby food to the prevention of scale in a boiler. It can measure ultra-pure water in a pharmaceutical facility or metal ions in a plating process.

Bürkert understands the broad scope and accuracy requirements of your individual process whether your needs require inductive principles, where no metal contacts the media, or the more common principle where contacting electrodes determine media properties using a direct resistive measurement.

Conductivity is measured by two main principles (conductive and inductive) which are visually explained in the next pages. Whichever you choose, Bürkert sensors have common electrical and process interfaces with pH/ORP transmitters and controllers. Conductivity, pH and ORP have similar menus, displays, Teach-In and volumetric calibration functions and all the materials have been chosen carefully to fit common applications using PEEK and PVDF to ensure long life and chemical compatibility.



Conductivity – Measuring Principles

Conductivity is a measurement of the ability of a solution to conduct an electric current. For metals the conductivity is given by the electrons. In fluids the number of ions such as metal or salt ions have direct influence to the conductivity. Higher ionic concentration yields higher conductivity. There are basically two measuring principles: The conductive principle and the inductive principle. Common to both is that the measuring device produces an alternating electrical voltage between two electrodes. Depending on the conductivity, a direct proportional current flow will be induced. The applied voltage generates a current that is determined by the resistance of the medium (Ohm's law). A second influence to the measured value is the cell constant of the measuring cell itself. The cell constant C describes the geometry of the electrodes by distance L between the electrodes and the measuring area A and is defined by its quotients $C=L/A$. The conductivity of the solution is calculated on the basis of this known cell constant C and by measuring the generated current.

Conductive conductivity – 2 electrode cell

The measuring of the conductivity can be done with 2-electrode cells or 4-electrode cells. The electrodes are in direct contact with the medium. In a traditional 2-pole cell, an alternating current is applied between the 2 poles and the resulting voltage is measured. In order to be able to cover a broad conductivity range, measuring fingers with various cell constants are used. The lower the conductivity, the lower the cell constant must be. The conductivity of ultra-pure water up to concentrated solutions can be measured depending on the cell constant selected. Measuring cells with cell constants $C=1$, $C=0.1$ and $C=0.01$ are available. A PT1000 temperature sensor is integrated for temperature compensation.

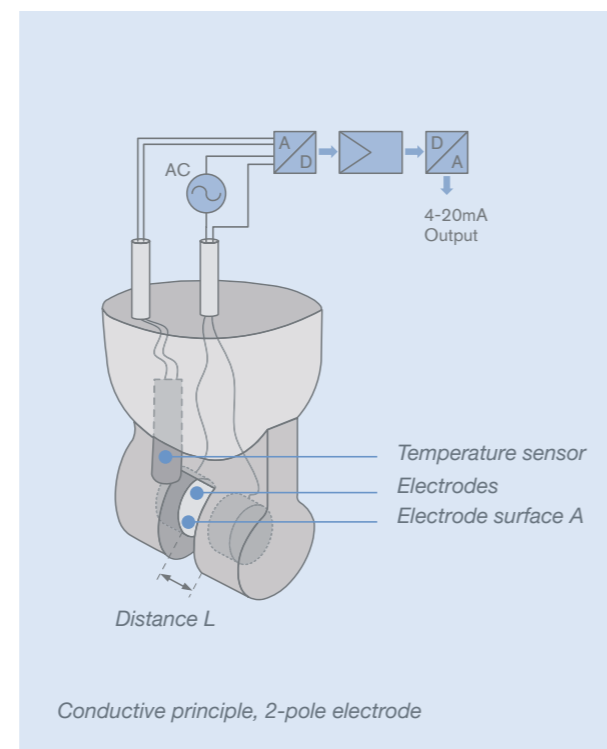

Conductive conductivity – 4 electrode cell

In a 4-pole cell, a current is applied to two opposite electrodes (current electrodes) in such a way that a constant potential difference is maintained between the other two electrodes (potential electrodes). As this voltage measurement takes place with a negligible current, these two potential electrodes are not polarized. Having no polarization effect enables the sensor to measure with one cell constant in a very large conductivity range.

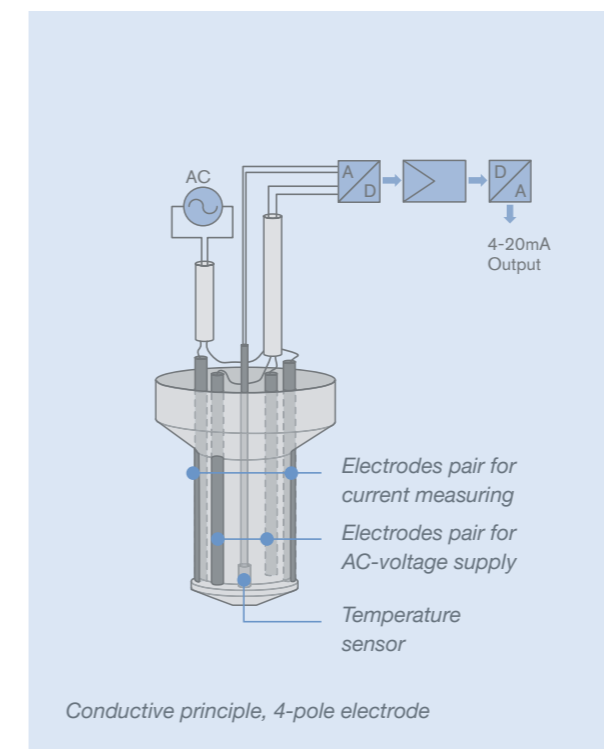



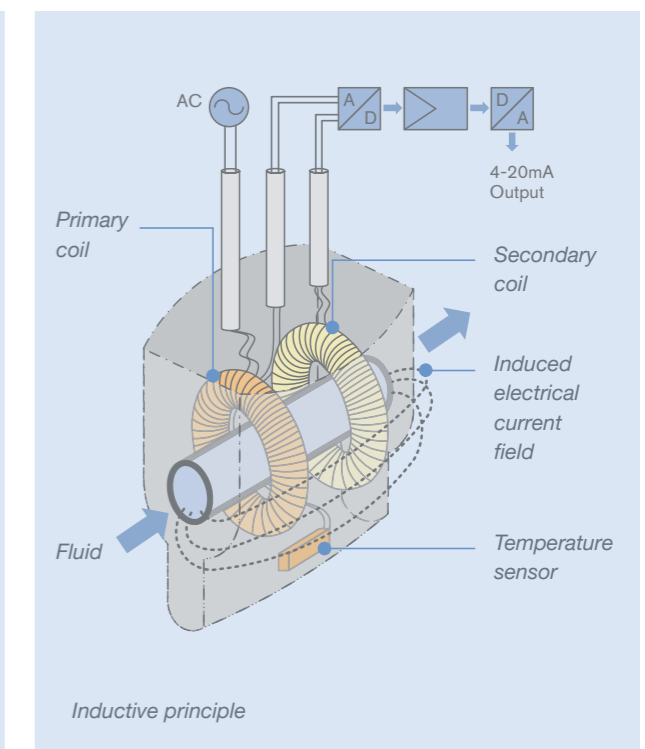

Inductive conductivity

An inductive conductivity cell consists of two coils: a field coil and a receiver coil. The coils are integrated in a finger-shaped housing. A bore is routed through the finger and the coils are integrated into it. The fluid encloses the finger and flows also through the bore. A sinusoidal AC voltage stimulates the field coil. This produces a current field in the fluid due to the conductivity of the fluid. This current field generates a voltage in the receiver coil. By measuring this voltage and knowing the cell constant, it is possible to determine the conductivity. A temperature sensor is integrated in the tip for temperature compensation to get a highly accurate and reliable 4-20mA output. This measuring method allows use in very problematic fluids. Owing to separation of the medium, all that needs to be ensured is that the housing has adequate resistance if used in such media. Since the measuring electrode has a very broad measuring range, different cell constants are not required. Use of the device is, however, not possible in very pure media since no measured value can be detected below a specific conductivity.



Conductivity Range

PID Controller	Alarm Relay	Output 4 - 20 mA	Relay switch	Transistor
				

Remote transmitter

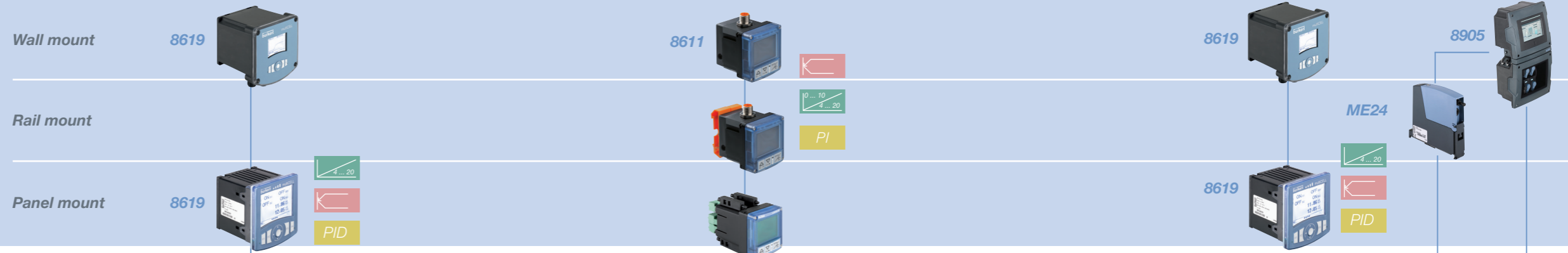

Compact meter

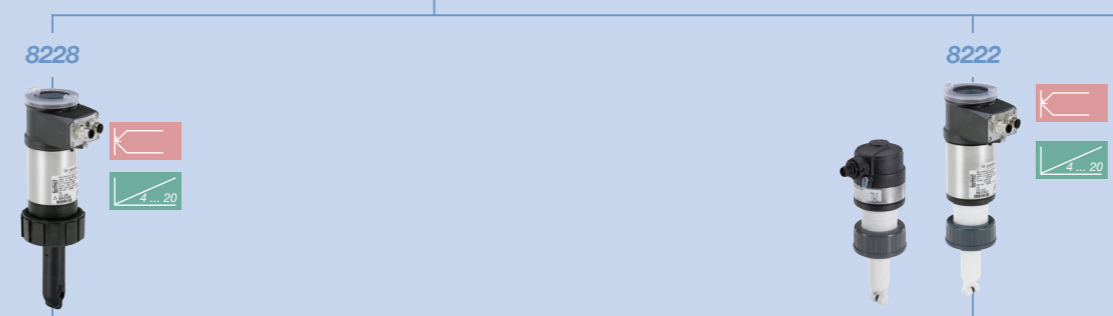

Sensor

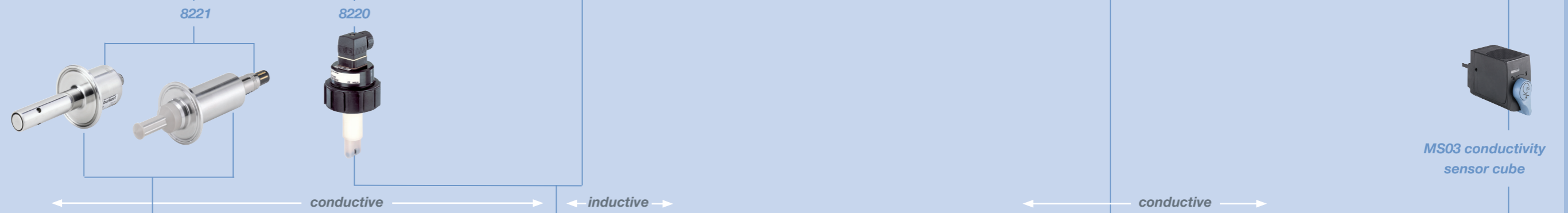

Fitting



Conductivity Features

Some versions offer approvals, see individual datasheets



Fluidic characteristics						
Measuring range	0.05 µS/cm to 200 mS/cm (0.2 S/cm) (depends on variant)	0.05 µS/cm to 200 µS/cm (depends on variant)	0.1 µS/cm to 500 mS/cm (0.5 S/cm) (depends on variant)	0.05 µS/cm to 10 mS/cm (0,01 S/cm) (depends on variant)	100 µS/cm to 2,000 mS/cm (2 S/cm)	50 µS/cm...1,000 µS/cm (0,001 S/cm)
Fluid pressure in bar	max. 10 bar (145psi)	max. 7 bar (100 psi)	max. 20 bar (flat electrode) (145 psi)	max. 16 bar (232 psi)	max. 10 bar (87p si)	PN3, min. 0,5 bar
Fluid temperature in °C	-15 to 100 °C (212°F)	-20 to 150 °C	-20 to 150 °C (302 °F)	-40 to 100 °C (302 °F)	-15 to 130 °C (248 °F)	0...+50°C (+32 ...+122°F)
Max. pressure at max. temperature	See P/T chart pages 78/79	See P/T chart pages 78/79	Insertion 6 bar at 135 °C Flush 20 bar at 150 °C	See P/T chart pages 78/79	See P/T chart pages 78/79	n/a
Wetted parts						
Sensor	PVDF1), SS	Stainless steel, PEEK 2)	EPDM 1)2), SS	EPDM 1)2), SS	PP, PVDF1) or PEEK1) 2)	PPE+PS / PC / EPDM
Seal	FKM1) or EPDM1)	EPDM 1)	EPDM 1)2)	FKM1) or EPDM1)	FKM1) or EPDM1) 2)	
Body	PVDF1)	Stainless steel	Stainless steel	PVDF1)	PP, PVDF1) or PEEK 1)2)	
Temperature compensation	Pt 1000	Pt 1000	Pt 1000	Automatic (selectable compensation curves)	Automatic (selectable compensation curves)	Pt 1000
Process connection	G 2" (S020)	Clamp 1 1/2"	Various hygienic clamps, Clamp 1 1/2"; Clamp 2", 2" (DN50/40) connection adapted for GEA Tuchenhagen VARINLINE process connections; PG 13,5; G1 1/4" Thread	G3/4" Thread (only neutrino) G 1 1/2" (S022)	G 2" (S020); Clamp 1 1/2"; Clamp 2"	EDIP fluidic backplane Type BEF1
Fitting type	S020	Clamp 1 1/2"	Clamp 1 1/2"; Clamp 2", 2" (DN50/40) connection adapted for GEA Tuchenhagen VARINLINE process connections; PG 13,5; G1 1/4" Thread	S022	S020; Clamp 1 1/2"; Clamp 2"	EDIP fluidic backplane Type BEF1
Electrical characteristics						
Basic function	Sensor	Sensor	Sensor	Sensor, Transmitter, Switch	Sensor, Transmitter, Switch	Sensor, Transmitter, digital communication acc. EDIP standard
Output signal	Analogue raw signal	Analogue raw signal	Analogue raw signal	2 x 4 – 20 mA, 2x Transistor	2x 4 - 20 mA; 2x Transistor	büS / CANopen
Output value	n/a	n/a	n/a	Conductivity and temperature	Conductivity or temperature	All internal data incl. conductivity, temperatures, internal voltages and currents acc. to EDIP standard
Display	No	No	No	Yes, removable	Yes, removable	No
Compatible transmitters	Type 8619	Type 8619	Type 8619	Integrated	Integrated	n/a
Measuring principle	Conductive (2-pole-electrode)	Conductive (2-pole-electrode)	Conductive (4-pole-electrode)	Conductive (2-pole-electrode)	Inductive	Graphit 2-pole-electrode system
Specifics		CIP compatible, inline sterilizable	CIP compatible, inline sterilizable, variant with EHEDG available		CIP compatible	Measurement up to 10 mS/cm possible at limited measurement deviation Configurable with Bürkert Communicator Type 8920

1) Wetted polymers in accordance to FDA; declarations of conformance available

2) Wetted polymers in accordance to EN1935/2004; declarations of conformance available

Conductivity – Selection Help

The selection of conductivity electrodes depends on the conductivity to be measured. The below figure shows an overview of the available conductivity sensors and the possible conductivity range.

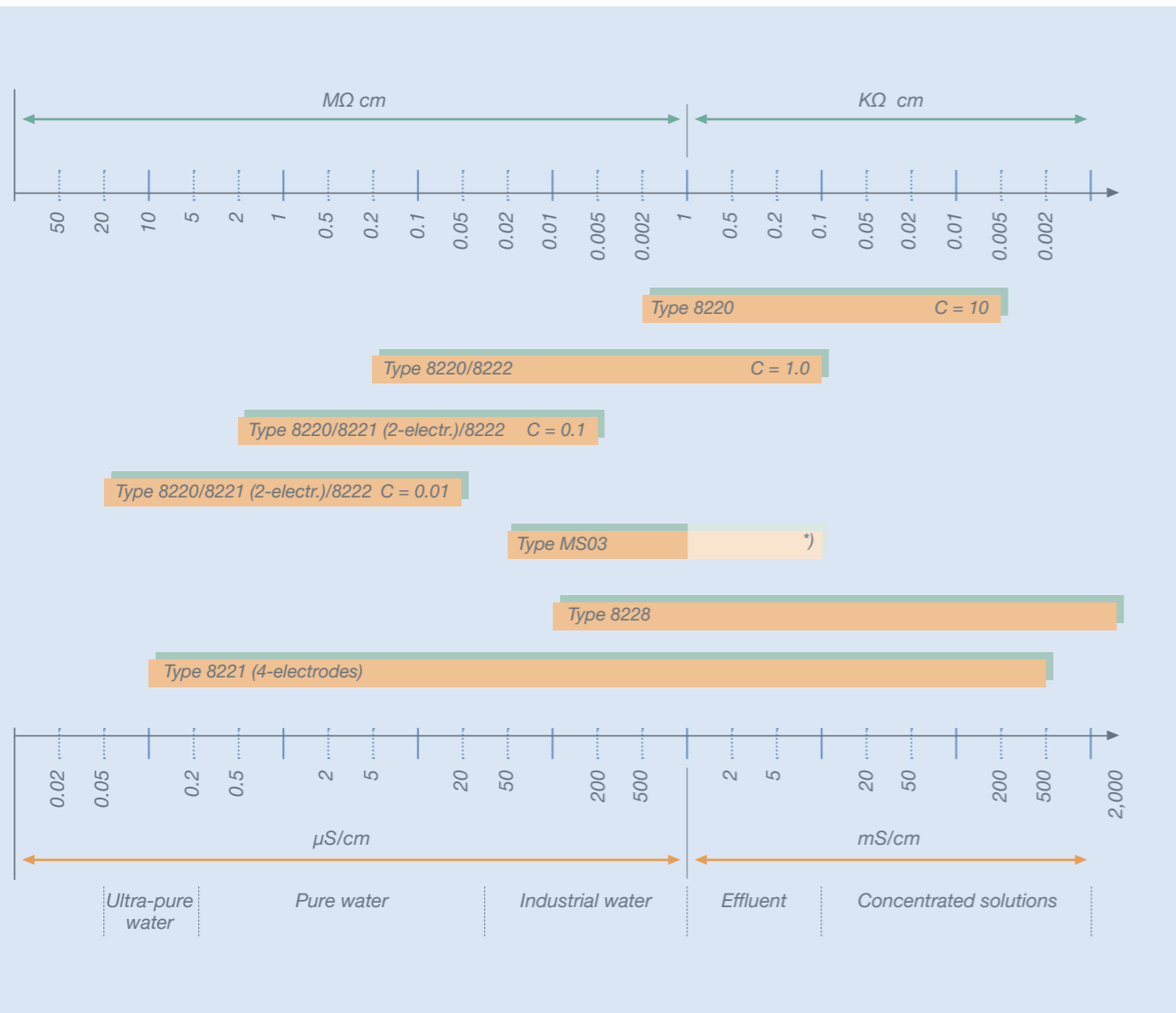

*) Measurement up to 10 μS/cm possible at limited measurement deviation

Conductivity of various concentrated and aqueous solutions

The two diagrams provide an overview of the conductivity values of solutions frequently used.

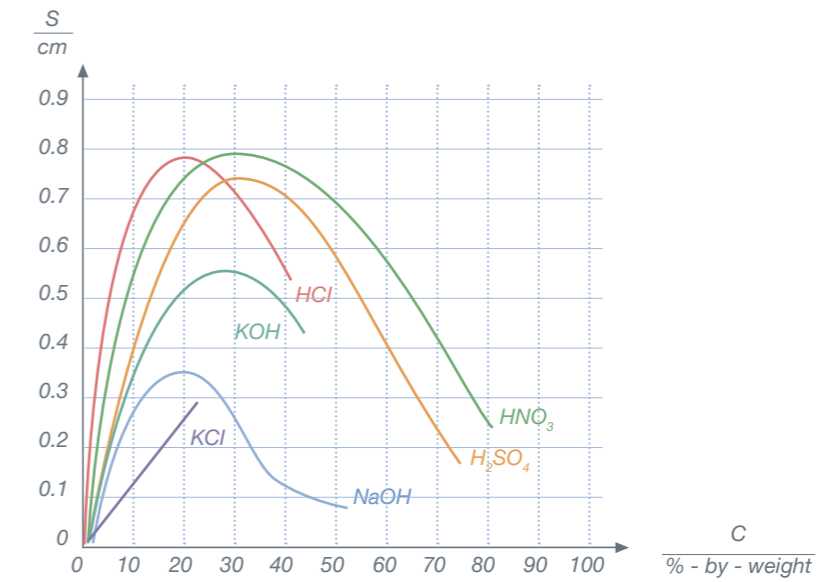

Conductivity of different fluids in dependence of the concentration. (Concentration in % by weight)

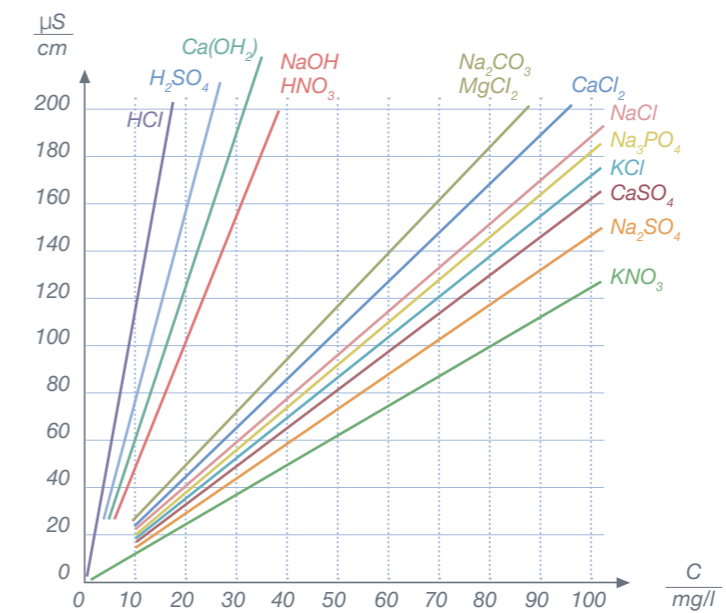

Conductivity of different fluids in dependence of the concentration. (Concentration absolute in mg/l)

Process Connection for pH/ORP/ Conductivity – Selection Help

The pressure resistance of plastics drops with increasing medium temperature. This dependence is shown for different sensor types in relation to the plastic materials, temperature and pressure. Please respect the pressure-temperature-range of each type and/ or variant. See corresponding datasheets.

Pressure / temperature chart for sensors with fittings S020

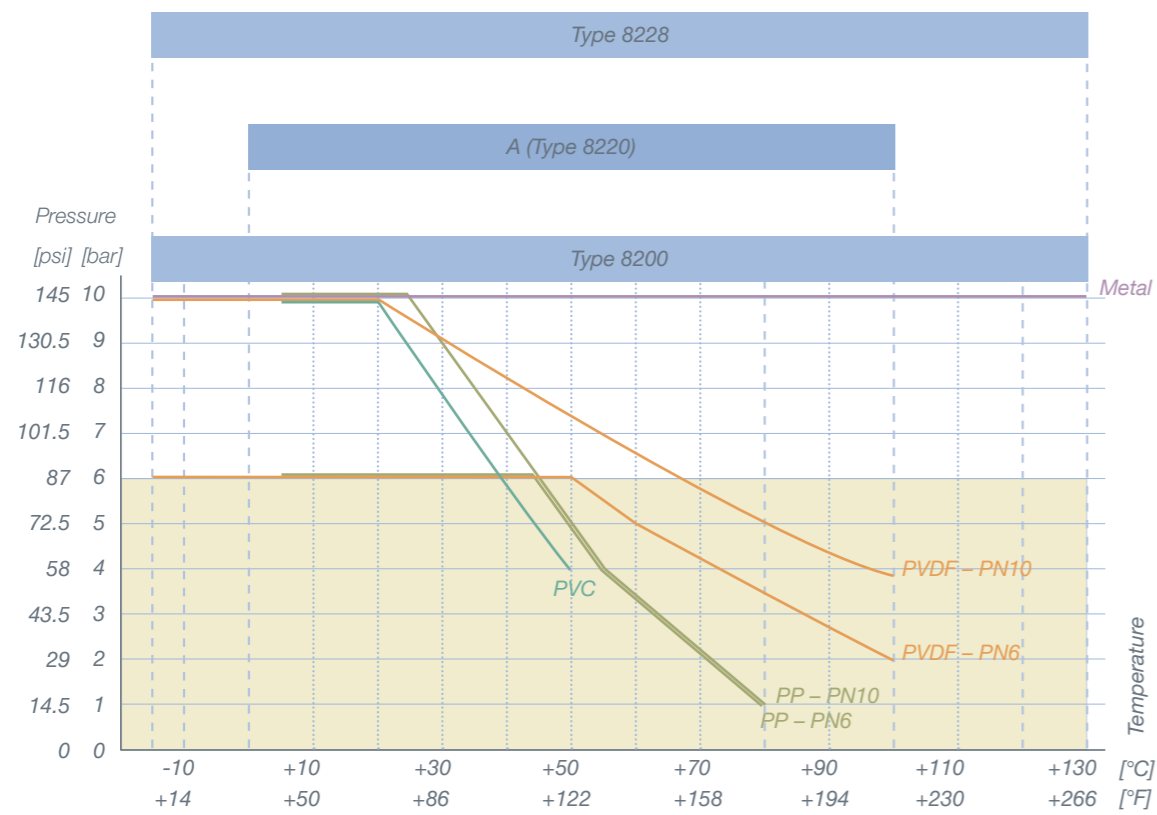

Max. pressure range 8228 with PP or PVDF-Sensor

Pressure / temperature chart for sensors with fittings S022

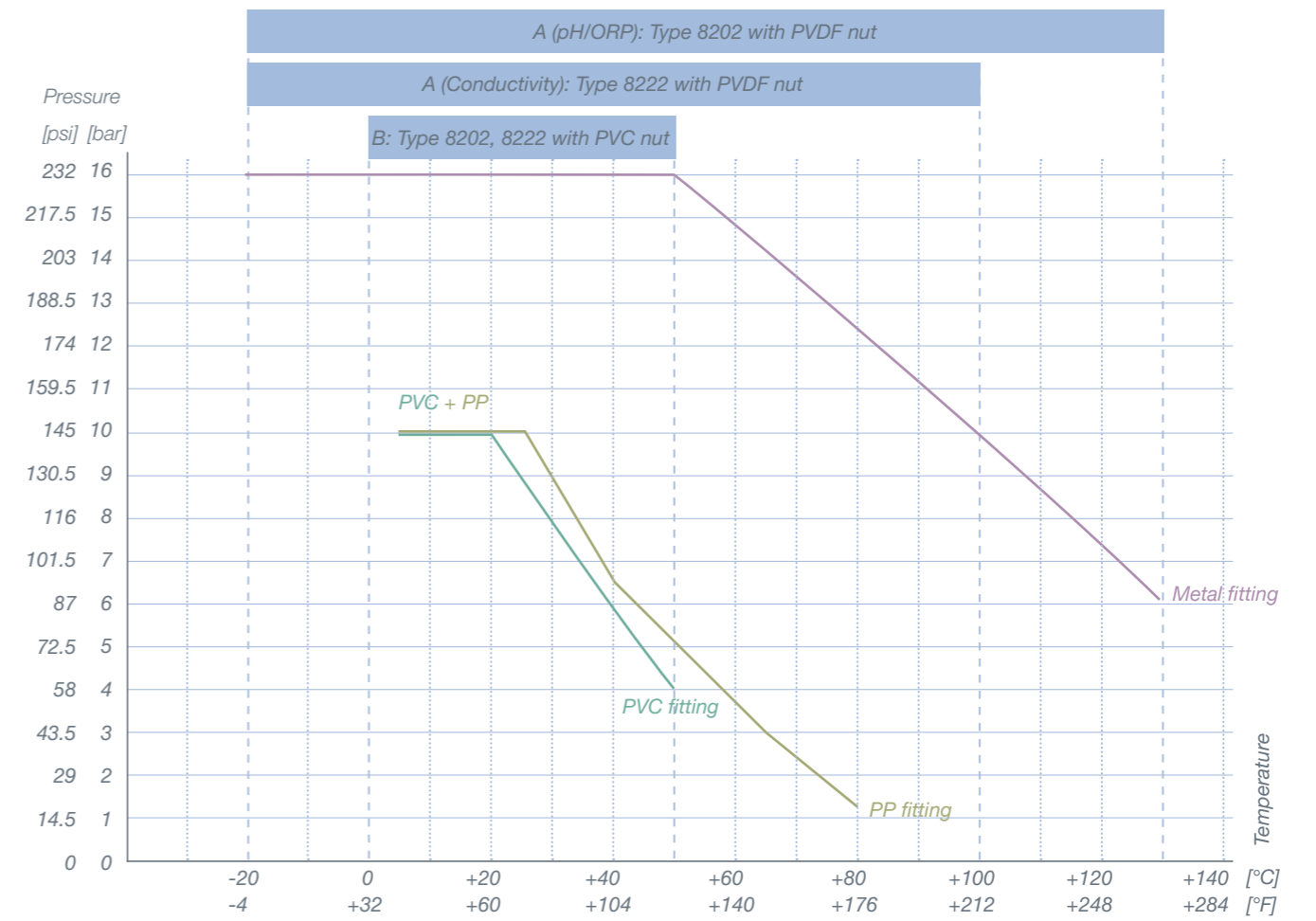

Process Connections for pH/ORP and Conductivity

Process connections for pH/ORP/Conductivity measuring



Bürkert distinguishes between 2 fitting variants to install the analytical sensors into the process:

- Fitting system S020 with G 2" nut
- Fitting system S022 with standard G1 1/2" thread

Insertion fitting system S020

Insertion series S020 fittings are available in plastic, brass or stainless steel. They consist of a connector with indentation, a plastic seal and a union nut for fixing the sensor in position. The connector is already permanently connected to a pipe fitting up to DN 50. A wide range of connection options for installation in a pipe are available (spigot, external thread, weld end, Triclamp or flange, etc.). In the case of nominal diameters from 65 to approx. 100 mm, it is advisable to use fusion spigots made of plastic. Individual connectors which can be welded in (stainless steel) are recommended for installation in tanks.

Combining the S020 with sensor for pH, ORP or conductivity measurement

Available fitting DN	T-fitting S020 	DN 65 (2½")	
	Welding tab S020 	DN 50 (2")	DN 200 (8")
	Fusion spigot S020 	DN 65 (2½")	DN 200 (8")
pH/ORP/Conductivity Types 8200 - 8205 - 8206 - 8220 - 8223 - 8225 - 8226		DN 15 (½")	DN 200 (8")

For detailed information see datasheet Type S020.

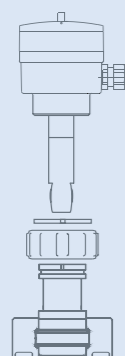

Installation example of a finger sensor in fitting S020

Standardized hygienic process connections for measuring pH, ORP or conductivity

For installation of analytical sensors into hygienic applications Bürkert provides several hygienic holder and process connections like:

- Clamp 1,5"
- Clamp 2"
- 2" (DN50/40) connection adapted for GEA Tuchenhagen VARINLINE process connections

Insertion fitting system S022

Insertion series S022 fittings are available in PVC, PVDF and PP. They consist of a metric or ASTM G 1 1/2" thread for connecting the insertion sensors 8202 or 8222.

Combining the S022 adaptors with analytical ELEMENT transmitters for pH, ORP and conductivity measurement

Available fitting DN	Adapter for standard plastic tees (PVC or PP) 	DN 32 (1¼")	DN 100 (4")
	DN 32 (DN 6 with reduction) to DN 100 with tee fittings		
	Welding tab for stainless steel tees or direct mounting into bigger pipes or vessels 	DN 32 (1¼")	DN 100 (4") ...
	DN 32 (tee fitting) or bigger (consider min. immersion depth)		
Screw-on for plastic pipes or plastic vessels PVC or PP 	DN 50 (2")	DN 100 (4") ...	
Process connection G or NPT 1 ¼" (consider min. immersion depth)			
Conversion kit for tee fittings S020 	DN 15 (½")	DN 65 (2½")	

For detailed information see datasheet Type S022.

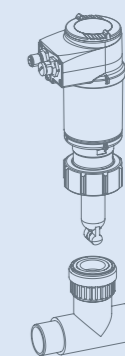

Installation example of a finger sensor in fitting S022

Disinfectants/Oxidants

Because of its excellent characteristics as disinfectant, chlorine is still one of the most important biocides for industrial water treatment, swimming pool or cleaning applications. But due to limitations of Chlorine (e.g. pH-dependency) disinfectants like chlorine dioxide become more and more important.

An efficient usage of oxidation and disinfectant agents depends on the correct concentration therefore an exact and reliable measurement is necessary. Bürkert provides flexible solutions for customer requirements and needs. No matter if very low or higher concentrations, stable or fluctuating pH values have to be measured, we can flexibly realize for our customers a measurement point for disinfectants and oxidants.

The measurement of chlorine or chlorine dioxide is done amperometrically. Because of their integrated compensation electronic, the sensors provide a non-temperature-dependent signal. Parameterization and calibration of sensors is done with the help of our universal transmitter / controller type 8619, the intelligent EDIP ME24 module or directly with the Type MS02 Sensor Cube.

An easy and fast installation into the process can be realized by our analytical measurement chamber type 8200. The measurement is done in bypass. The sample water flow can be monitored with an optional available inductive switch.



Chlorine Sensor type 8232 mounted on analytical measurement chamber type 8200

Disinfectants/Oxidants – Measurement Principle

The sensor for measuring the free chlorine concentration consists of an encapsulated electrode-electrolyte system. The contact to the measurement water is done with a membrane.

Within the electrolyte system there are the working and the reference electrode. At the working electrode a specific chlorine-dependent reaction takes place. This reaction needs a special potential at the working electrode. The resulting current (nA-range) is proportional to the concentration of free chlorine in the measurement water. Depending on the version there is a third electrode with direct contact to the measurement water, the counter electrode. Thereby it is possible to measure potentiostatic. That means, the voltage between working and reference electrode is kept constant.

A special electrolyte and membrane combination allow versions with a strong reduced pH-dependency. Furthermore it is possible to reduce the building of biofilms on the membrane surface. An active cleaning is not necessary as the working electrode is protected by the membrane.

A temperature probe is integrated to compensate the temperature effect. The special electronic provides a temperature-nondependent mA or mV-signal. The sensor is zero-point stable therefore an offset-calibration is not necessary. Slope calibration can easily be done with our flexible transmitter / controller type 8619.

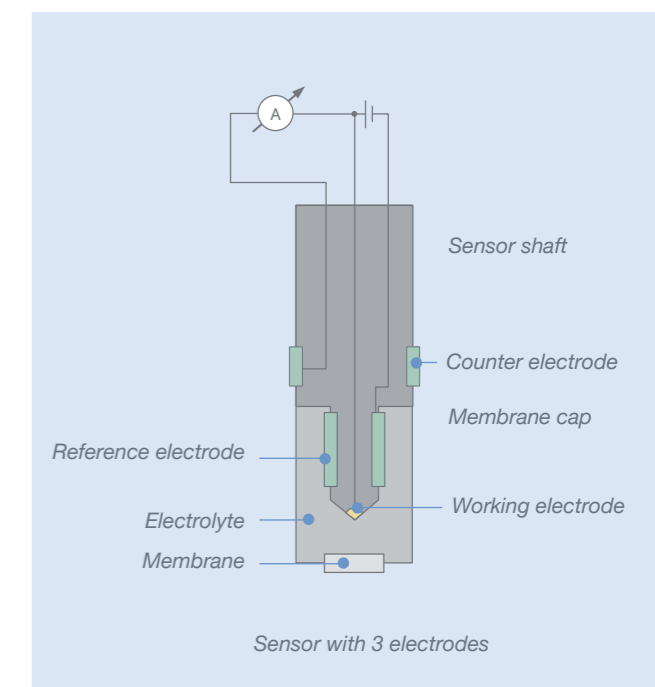
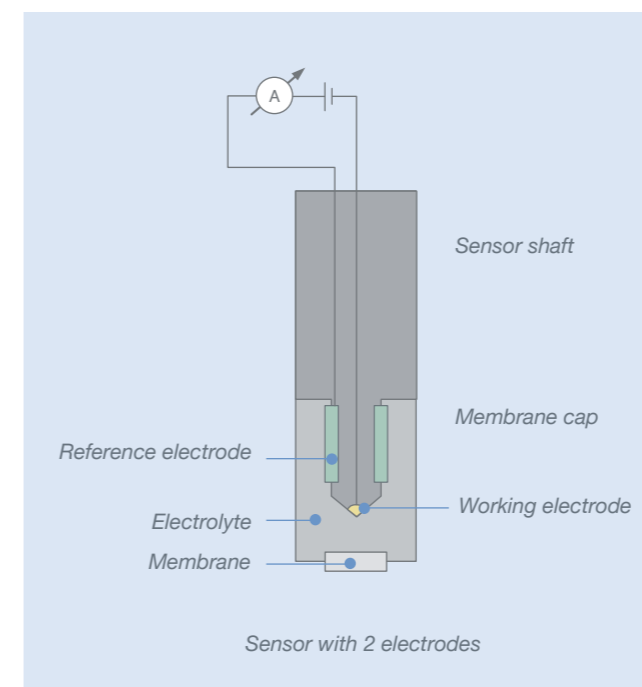

Disinfectants/Oxidants Range

Remote transmitter

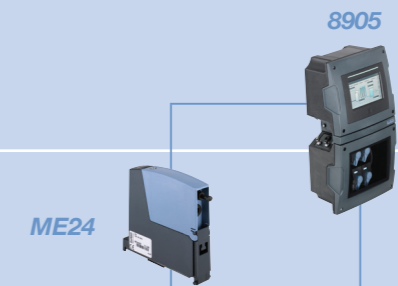
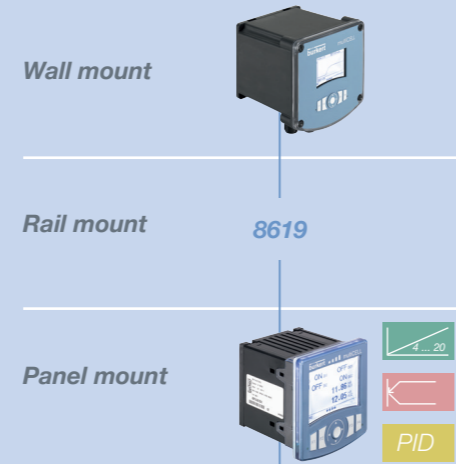

Sensor

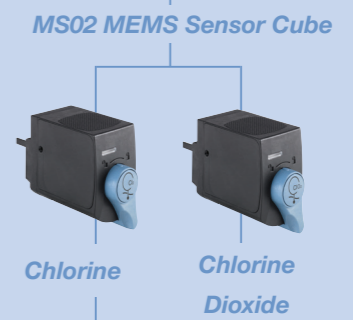
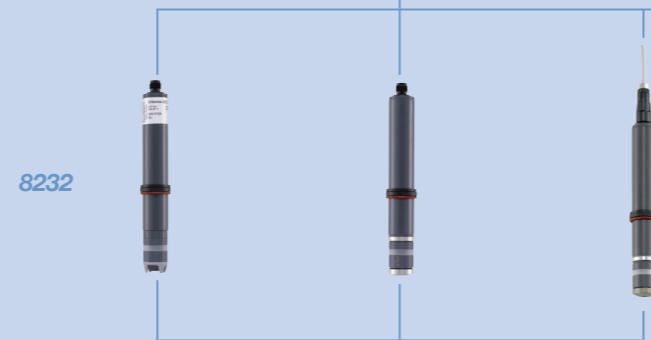





Analytical measurement chamber



Fitting

Disinfectants/Oxidants Features

Some versions offer approvals, see individual datasheets

Typ 8232 Chlorine Sensor	Type 8282 Trace Sensor (Zero-Chlorine Sensor)	MS02 Chlorine MEMS Sensor Cube	MS02 Chlorine Dioxide MEMS Sensor Cube
			

Fluid characteristics				
Measuring range	0.01 ... 20 ppm	0.005 ... 2 ppm	0.01...5 ppm	0.005...5 ppm
Fluid pressure	depends on variant max. 3 bar	max 0.5 bar	PN3, min. 0.5 bar	PN3, min. 0.5 bar
Fluid temperature in °C	0 ... 45°C	0 ... 40 °C	0...+50°C (+32...+122°F)	0...+50°C (+32...+122°F)
Wetted parts Sensor Seal	PA, PVC; Silicone; VA NBR	PA, PVC; Silicone; VA NBR	PPE+PS / PC / EPDM	PPE+PS / PC / EPDM
Temperature compensation	Integrated	Integrated	Pt1000	Pt1000
Process connection	To be installed in analytical measurement chamber type 8200	To be installed in analytical measurement chamber type 8200	EDIP fluidic backplane Type BEF1	EDIP fluidic backplane Type BEF1
Media	Variants for drinking-, sea- or swimming pool water	Drinking water	EDIP fluidic backplane Type BEF1	EDIP fluidic backplane Type BEF1
Electrical characteristics				
Basic function	Sensor	Sensor	Sensor, Transmitter, digital communication acc. EDIP standard	Sensor, Transmitter, digital communication acc. EDIP standard
Output signal	mA or Signal	mV-Signal	büS / CANopen	büS / CANopen
Output value	Uncalibrated concentration of free chlorine	Uncalibrated concentration of free chlorine	All internal data incl. HOCl Value, temperatures, internal voltages and currents acc. to EDIP standard	All internal data incl. ClO2 value, temperatures, internal voltages and currents acc. to EDIP standard
Display	No	No	No	No
Compatible transmitter	Types 8619, 8905 (with ME24)	Types 8619, 8905 (with ME24)	n/a	n/a
Comment	Variants available for fluctuating pH value Optional inductive switch available for sample water monitoring (Type 8200)	For monitoring the absence of chlorine in water (up to 4 weeks) Optional inductive switch available for sample water monitoring (Type 8200)	For monitoring the absence of chlorine in water pH compensation when pH Sensor Cube MS01 is connected on same EDIP backplane BEF1 Configurable with Bürkert Communicator Type 8920	For monitoring the absence of chlorine dioxide in water Configurable with Bürkert Communicator Type 8920

Iron – Measuring Principle

In addition to the basic parameters of pH value, ORP/redox potential, conductivity, disinfectant concentration and turbidity the measurement of specific content may be very important. Special parameters of single treatment steps also need to be integrated for monitoring the uninterrupted and efficient operation of the treatment step. Before filtering water and the disinfection of water there is the need to take out all oxidizing content from the raw water in a first step. Iron is one of the contents to be removed. An iron measurement is applied to check whether the removal works efficiently.

Iron content in water is typically analyzed offline by a color change reaction by a photometric measurement. The same effect is used to analyze the iron content online by a flow injection analysis module (FIA) which allows a miniaturized and an EDIP compatible design of an iron measurement. The FIA module provides all needed process steps on the way to an iron analysis:

- Sampling of a water bypass stream
- Degasing the sample to avoid unwanted and disturbing gas/air bubbles
- Loading the sample with the reagent
- Mixing of reagent and sample water for getting a homogenous liquid color through the reaction
- Detection of the colour change and calculation of the related iron content

Each measurement cycle is accomplished by a

- cleaning cycle and an
 - offset detection
- for getting high accurate measurement results.

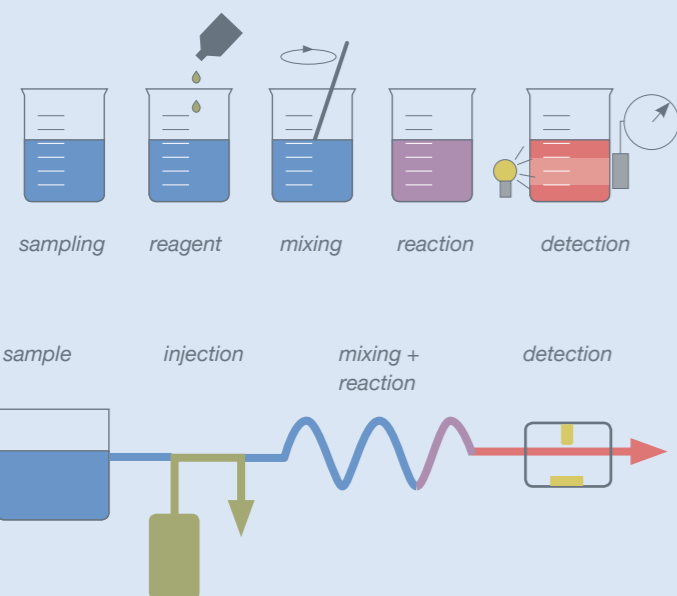

The steps which are provided fully automatically in a FIA module.

The FIA iron is detecting the dissolved iron (Fe^{2+} / Fe^{3+}) content in water. The reaction is driven by a reagent which is reducing Fe^{3+} to Fe^{2+} as of additional compounds. This reflects the standardized value of dissolved iron which is concerned in the water guidelines. The total iron consists also of undissolved solid iron which is not detected through the FIA.



FIA Iron in an online analysis System Type 8905

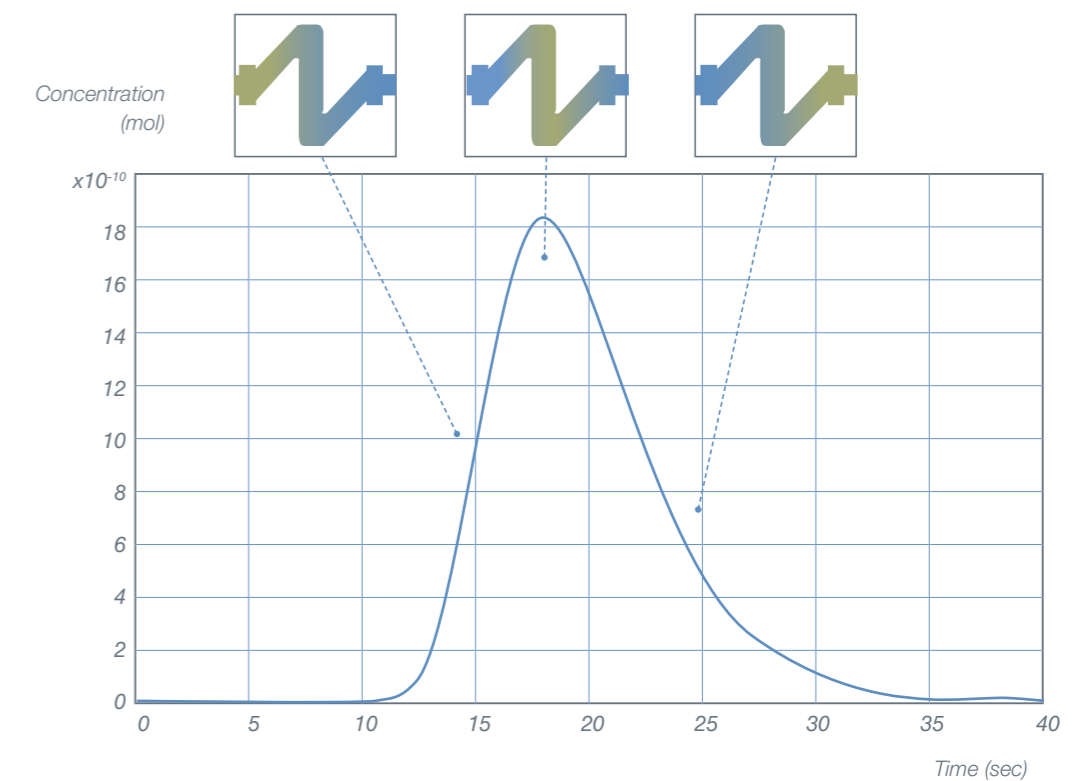

Colour change over time which is detected by a flow injection analysis

Turbidity – Measuring Principle

There are different reasons for using a continuous turbidity measurement in water treatment:

1. Turbidity measurement provides information about the efficiency of treatment steps
2. Legislative regulatory and guidelines (WHO, local water guidelines, ...)
3. On site quality management reasons

... and more ...

Turbidity in water is caused by undissolved inorganic content or organic particles. Turbidity is totally unwanted in drinking water and in most process water there has to be a specific turbidity not to be exceeded. The measurement is (and was ever) an optical measurement. In former times it was just a visual check of the distance how far someone can look into a water basin and see the plates with numbers to read the "turbidity". Today the optical measurement method is standardized for example in ISO/DIN or EPA rules. In both cases the measurement is a scattered light detection – for a low turbidity in treated water and drinking water. Very high turbidities are measured with straight light measurements.

The Sensor Cube for turbidity is a miniaturized turbidity meter which fits in the Type 8905 Online-Analysis-System. The sample water comes from the system backplane and the flow is through a small chamber where a light is emitted into. In addition to the 90° optical sensor there is one straight through the measurement chamber to compensate influences from very big particles or bubbles. As turbidity measurement is a sensitive optical measurement it is strongly recommended to use bubble trap in the sample water inlet line and an automatic cleaning module Type MZ20.

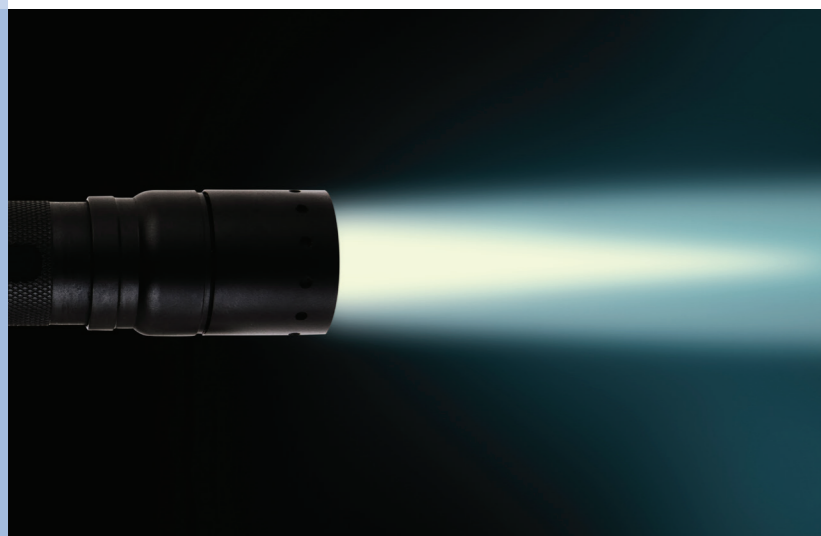

Reading the turbidity is looking to a light beam from an 90° angle and detecting the intensity of the scattered light. This is similar to the light in fog you can see from beside.



Online Analysis Sensor Cubes – Overview

Some versions offer approvals, see individual datasheets

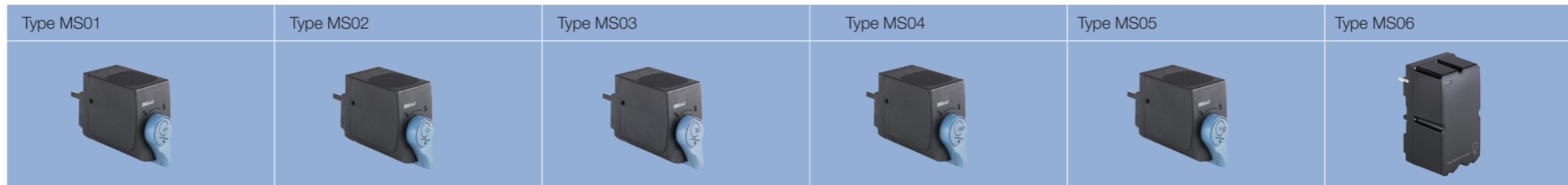

Basic Characteristics						
Analysis Methode	MEMS - IS FET electrode vs. Ag/AgCl Reference	MEMS - Membrane covered 3 electrode cell	Graphite 2-electrode system, C = 1	MEMS - platinum electrode vs. Ag/AgCl Reference	Scattered light 90°	Flow Injection Analysis (FIA)
Parameter to be measured	pH Value	Chlorine (HOCl); Chlorine dioxide (ClO ₂)	Conductivity	ORP, Redox potential	Turbidity	Iron (Fe ²⁺ / Fe ³⁺)
Analysis Characteristics						
Measurement range	pH 4... pH 9	HOCl: 0.01 ... 5 ppm ClO ₂ : 0.005 ... 5 ppm	50 µS/cm ... 1,000 µS/cm	-2,000...+2,000 mV	0 ... 40 NTU/FNU	n/a
Accuracy	0.1 pH acc. standard JCGM 200:2012	HOCl: ±0.03 ppm or ±5% of reading ClO ₂ : ±0.005 ppm or ±3% of reading	±2% of reading	± 10 mV	±0.02 NTU/FNU or ±2% of reading	n/a
T(90%)				< 10 sec.	< 1 sec.	
Compensation (included)	Temperature	Temperature, pH-value	Temperature	Temperature	transmitted light	n/a
Sample Water Characteristics						
Flow	>6 l/h			>6 l/h		
Pressure	PN3; min. 0.5 bar			PN3; min. 0,5 bar		PN1; min. 0,5 bar
Temperature	3 ... 40°C			3 ... 40°C		
Quality	Particle free (<100µm), treated water: drinking water, industrial water			Particle free (<100µm), treated water: drinking water, industrial water		
Connection	Type BEF1 Backplane, Connected to process by tube 4/6 mm; sample water discharge to open drain			Type BEF1 Backplane, Connected to process by tube 4/6 mm; sample water discharge to open drain		
Sample Water Characteristics						
Power supply	Via büS through the EDIP Backplane Type BEF1; 24 VDC			Via büS through the EDIP Backplane Type BEF1; 24 VDC		
Communication	Via büS through the EDIP Backplane Type BEF1; All information which is needed to run a Sensor Cube within an EDIP System is stored in each Sensor Cube internally – incl. all calibration, operation parameters, limit and alarm values as well as the menu to operate the Sensor Cube via the Systems 7" Touch Display. For easy exchange of Sensor Cubes there is a SIM card on each Sensor Cube with the copy of all internal data. For connection to supervision systems please refer to the Type 8905 pages. Each Sensor Cube indicates operation by a multicolor status LED.			Via büS through the EDIP Backplane Type BEF1; All information which is needed to run a Sensor Cube within an EDIP System is stored in each Sensor Cube internally – incl. all calibration, operation parameters, limit and alarm values as well as the menu to operate the Sensor Cube via the Systems 7" Touch Display. For easy exchange of Sensor Cubes there is a SIM card on each Sensor Cube with the copy of all internal data. For connection to supervision systems please refer to the Type 8905 pages. Each Sensor Cube indicates operation by a multicolor status LED.		
Remarks						
	Easy to exchange external reference electrode incl. KCl reservoir.	Chlorine measurement can be compensated to free chlorine measurement by a pH-Sensor Cube connection on the same sample water line.	Measurement up to 10 mS/cm possible at limited accuracy	Easy to exchange external reference electrode incl. KCl reservoir.	Versions: Standard DIN/ISO 7027 EPA Methode 180.1	Supply for reagents for FIA is provided by RGU Type MZ30. Discharge of reagent contaminated sample into a separate waste tank (externally)

Online Analysis System Type 8905 System – Accessories

1. The Cleaning Module MZ20 and the Control Module ME24 are fully compatible to type 8905 systems. The Cleaning System is designed to clean the fluidic channels and in case the sensor area in the connected sensor cubes using up to two cleaning liquids. The cleaning is proceeded fully automatically. When a cleaning is requested e.g. by a timer within the control module, all necessary steps are started. Sample water stop -> dosing of cleaning liquid -> duration when cleaning is active -> flush system -> in case: dose next cleaning solution. All timers and criteria are user defined and this allows optimized adjustment to the cleaning demand. The cleaning parameters might be set via 7" touch display at the 8905 Online-Analysis-System or by a Bürkert Communicator. Using the automatic cleaning system allows reducing the manual cleaning of the sensors and improve the long term stability of the measurements. The cleaning system operates without maintenance except the change of empty tanks by new filled cleaning solutions.

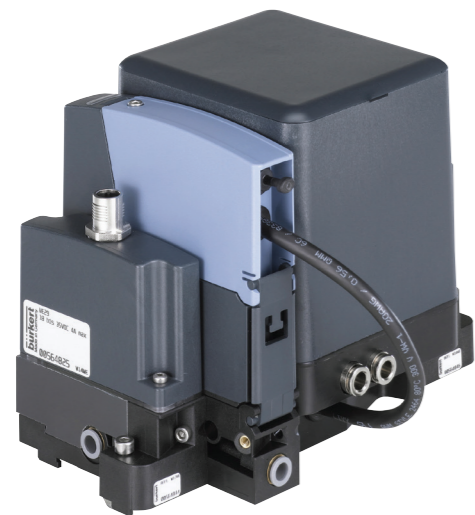

Automatic Cleaning System consisting of a cleaning module Type MZ20 directly connected to one Sensor Cube Type MSxx. On the left side is the I/O Module Type ME24 which provides the control of the cleaning module.

2. If there is no need for cyclic automatic cleaning then the use of the handheld cleaning module Type MZ15 is advised. The handheld cleaning module is a standalone unit which works without online connection to an EDIP system. The cleaning starts with just plugging a Sensor Cube into the fluidic slot of the handheld cleaning module. The cleaning solution is to be fixed at the bottle connector. Then a battery driven pump starts as soon as the ON/OFF button is pressed. The cleaning solution circulates through the Sensor Cube. The circulation can be stopped to provide an exposure time depending on the cleaning demand. After the cleaning the Sensor Cube is plugged back into the Online Analysis System.



Handheld cleaning unit Type MZ15: An easy to use unit for cleaning the fluidic path and the measurement chamber of a Sensor Cube

3. In case of calibration demand from time to time there is the use of the handheld calibration module one of the options. If there are compare measurements available the easiest way of Sensor Cube calibration is to set the online analyzed values to the compare measurement value. To avoid reading errors or if there is no compare measurement available at the moment of calibration then the use of the handheld calibration module is advised. The handheld cleaning module has to be connected to an EDIP System with a display (either communicator on a PC or a 7" display within a Type 8905 System). Prior the calibration routine the calibration solution has to be connected. The calibration solution is only used for one calibration to

avoid dilution of the calibration solution. So there is the need to connect also an empty bottle for the waste. The sensor cube has to be plugged into the fluidic slot. Then the calibration can start in dialog with the connected display. After calibration the calibration is stored on the cube. The calibration information can later be downloaded for documentation purposes.



Handheld calibration unit Type MZ15: Calibration can be done by plugging in the right calibration buffer and the Sensor Cube. Operation is controlled via a connected Bürkert Communicator or a Type 8905 system with 7" touch display.



Sensor Loop Applications

Flow control

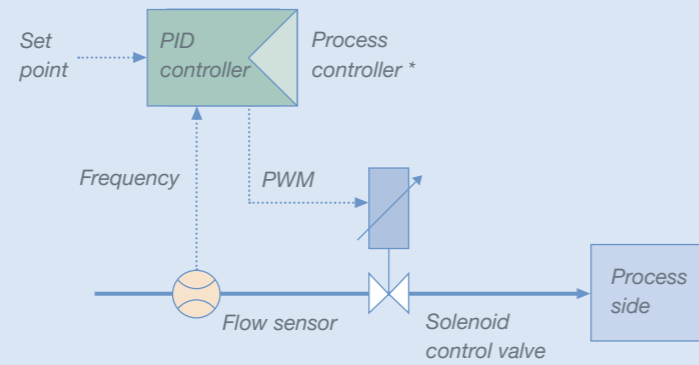

Temperature control

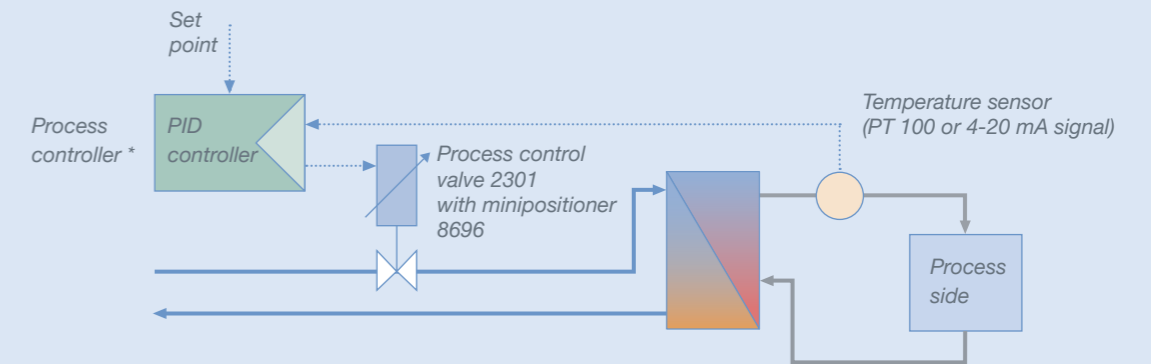

Pressure control of vessels for filling process

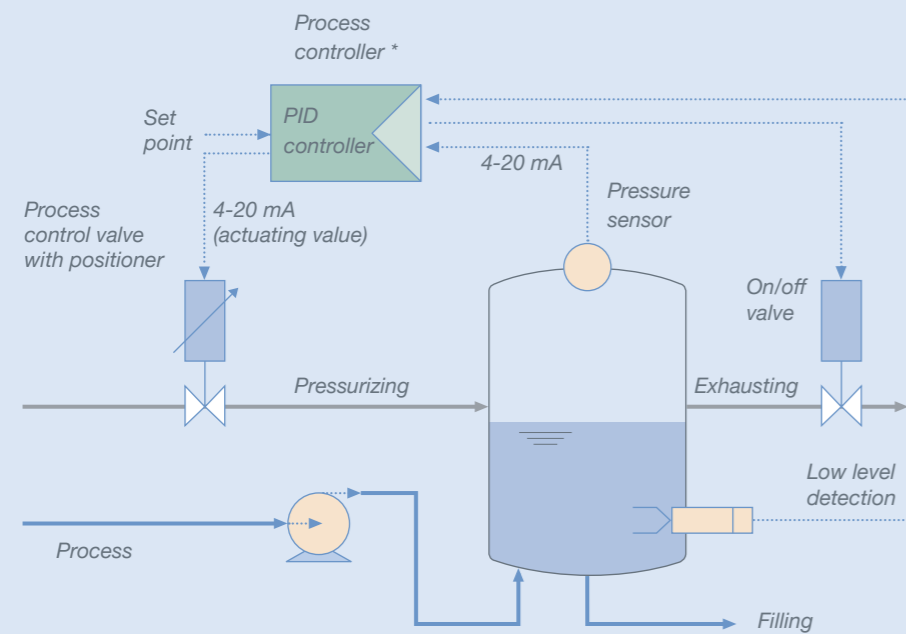

Level control

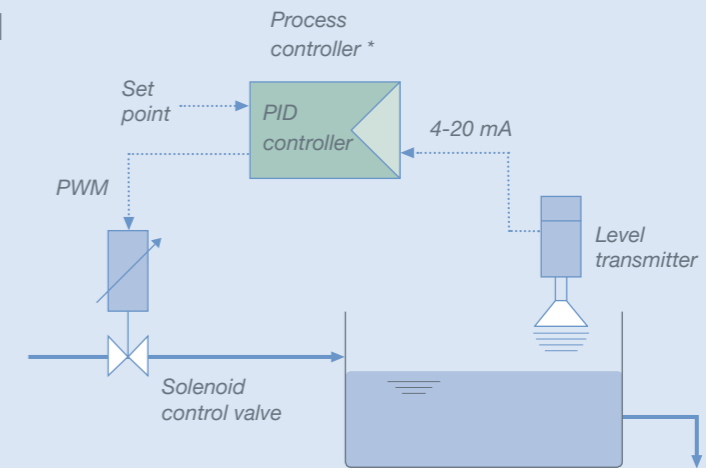

- * All Applications can be controlled by the integrated PI / PID controllers or limit value settings in
 - multiCELL Type 8619
 - Online Analysis System Type 8905 with a ME24 f(x) module
 - eControl Type 8611
 - Process controllers Types 8693/8793

The example in this chapter shows a minimum function of the f(x) capabilities of the EDIP platform (in Type 8905). f(x) provides the full range of arithmetical and / or logical functions to control processes.

Analytical Sensor Loop Applications

pH-control

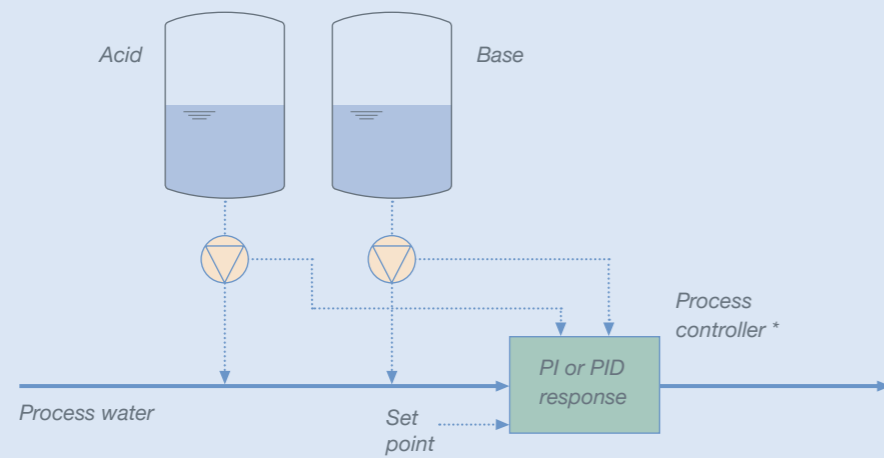

pH-Control can be performed by the integrated PI / PID controllers or limit value settings in

- multiCELL Type 8619
- Online Analysis System Type 8905 with a ME24 f(x) module

The example in this chapter shows a minimum function of the f(x) capabilities of the EDIP platform (in Type 8905). f(x) provides the full range of arithmetical and / or logical functions to control processes.



Iron content reject control

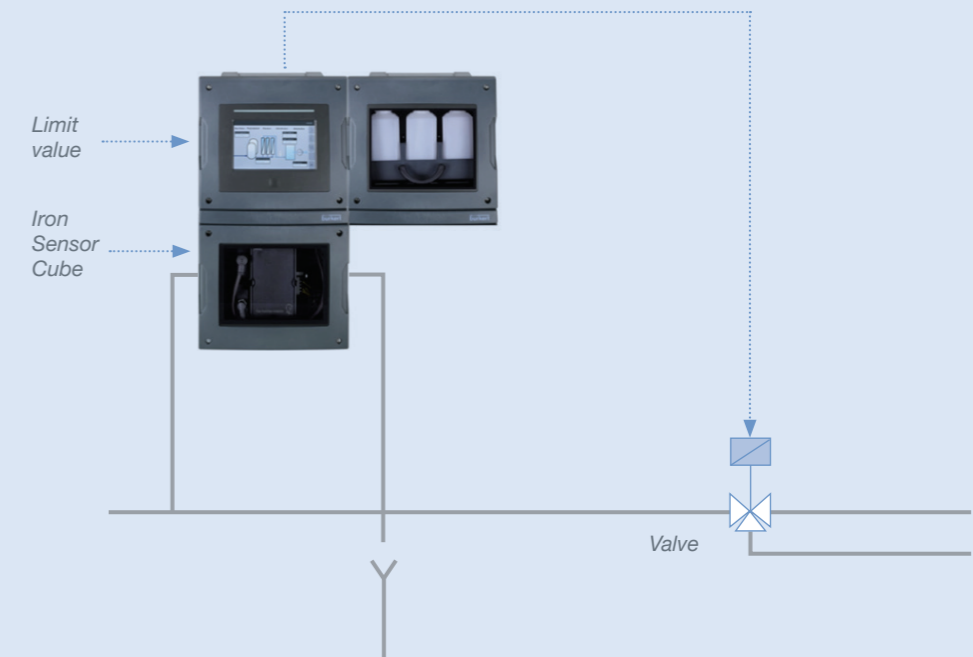

Iron content reject control can be performed by the integrated PI / PID controllers or limit value settings in

- Online Analysis System Type 8905 with a ME24 f(x) module

The example in this chapter shows a minimum function of the f(x) capabilities of the EDIP platform (in Type 8905). f(x) provides the full range of arithmetical and / or logical functions to control processes.



Added Value Systems

Bürkert has a unique perspective in the process control and instrumentation industry as we are the only brand which combines a complete range of valves, instruments, pneumatic actuation, networking and controllers from a single source.

With our dedicated world-class engineers and our superlative manufacturing facilities we can deliver systems which meet your exact requirements.

Your reliable Bürkert sales consultant and our system engineers work in concert to ask the right questions and provide the right hardware. Transparent operations, up to date situation, review procedure, engineering change notices, portals through SAP and secure intranet are normal in our projects.

For a world class system experience, insist on Bürkert people to be part of your next project.



01 Connect

As a globally flexible, lean, focused and innovative company we are the partner of choice for fluid control systems in more than 35 countries. Whether you are in Stuttgart, Singapore, Chicago or Sydney, everywhere in the world, we are close to you and therefore know at first-hand about your specific tasks and problems.

Following our principle of "one face to the customer", you have a competent, reliable consultant by your side at all times, who listens to your needs and presents a solution in your daily application language ... crossing conventional boundaries and creating synergies between industries in pursuit of your ideal solution.

Systemhaus crews in Charlotte (USA), Suzhou (China), Dresden, Ingelfingen and Dortmund are continuously in innovation mode. They creatively engineer cost effective solutions to meet difficult process challenges for our customers.



02 Conceive & Innovate

Your project team starts working for you: from your reliable sales consultant, qualified industry specialists to dedicated system engineers – Bürkert puts the necessary experts together.

For the entire duration of the project they work together, combining their experience and clarifying all the requirements in close cooperation with you to come up with a feasible draft of your solution within the shortest timeframe.

CAD-created animations or simulations, combined with extended manufacturing, materials, tool design, construction and assembly knowledge enable us to provide a rough but firm production concept for your system at an early stage.

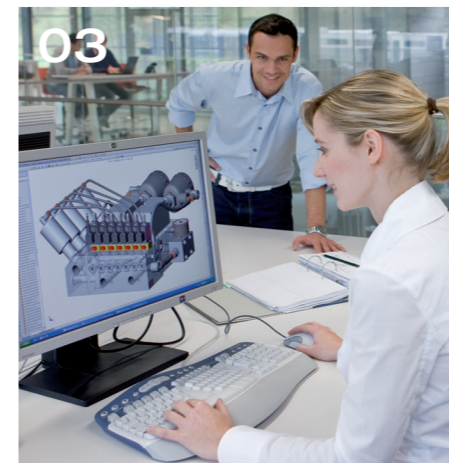

03 Plan & Specify

In Phase 3 the project is planned in detail. A specification sheet and refined solution concept are developed. This defines exactly what you expect from the system and what it must provide to ensure that all components meet your requirements.

At the end of this phase you are presented with a detailed product definition, a production specification and precise commercial conditions and agreements.

Structured project management based on open communication, effective coordination and thorough documentation ensures fast and reliable results.



04 Do & Check

Good communication, coordination and documentation at all project phases make sure that we are on the right track, developing the right solution, to allow us to quickly move on to prototyping.

Thanks to the latest technology, we are able to build a prototype made of metal or plastic or a functional model to test flow for example within 24 hours.

We provide you with samples; we perform tests and, of course, obtain all the necessary local and global approvals to make sure the system can go to production.

From here we work in concert with one of our production facilities in Ingelfingen, Gerabronn, Criesbach, Öhringen or Triembach according to their individual core manufacturing competencies.



05 Complete

Our work does not end with the perfect delivery of components and systems. We offer a comprehensive program to our global clients interlinking services ranging from maintenance and service contracts, operator training and integrated logistics.

Our customer service is available around the clock, offering support through internet, telephone or our qualified, experienced people at your site.

We aim to provide only the utmost in customer experience. Something you will tell your friends about.

Bürkert – Close to You

For up-to-date addresses
please visit us at
www.burkert.com.

- Austria
- Belgium
- Czech Republic
- Denmark
- Finland
- France
- Germany
- Italy
- Netherlands
- Norway
- Poland
- Portugal
- Spain
- Sweden
- Switzerland
- Turkey
- United Kingdom
- Russia
- China
- Hong Kong
- India
- Japan
- Korea
- Malaysia
- Philippines
- Singapore
- Taiwan
- Canada
- USA
- Argentina
- Brazil
- Uruguay
- South Africa
- United Arab Emirates
- Australia
- New Zealand