

Bronze overview

Our Bronze Series loudspeakers have been carefully designed to portray Monitor Audio's rich heritage together with an attractive contemporary touch. With a complete upgrade in sound and build quality, everything has been created with you in mind.

The fresh cabinet designs have clean and simple lines and are available in a choice of four contemporary finishes, with a sleek contrasting baffle and matching magnetic cloth-covered grille for an understated appearance.

The unique, acoustically transparent hexagonal dispersion patterns on the tweeter covers give Bronze a premium feel and allow light to catch the distinctive gold tweeter dome behind the grille.

The Bronze speakers are undoubtedly in a different class. Premium gold-plated terminals and Pureflow silver-plated oxygen-free copper internal cabling offer secure cable connectivity.

We have used our five decades of design experience to ensure that the Bronze speakers give an unforgettable performance wherever they are positioned in your home.

Since its first launch two decades ago, the multi award-winning Bronze Series has set the standard as a class leader and today there are thousands of satisfied owners across the globe.

With a choice of eight models, including our first Dolby Atmos® enabled module, all the Bronze speakers have been designed to please any music or movie lover. Their attractive styling and the choice of finishes ensures that they will complement any room in the home.



Bronze features

Acoustically transparent hexagonal pattern grille

Transparent hexagonal dispersion pattern for the Monitor Audio family look

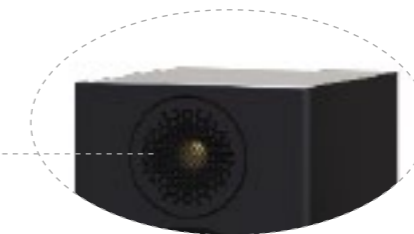

25 mm C-CAM Gold Dome Tweeter featuring Uniform Dispersion (UD) Waveguide

An evolution of the Monitor Audio signature C-CAM Gold Dome tweeter featuring Uniform Dispersion (UD) Waveguide for a more life-like sound.

C-CAM mid-bass drivers

Newly designed drivers featuring updated cone geometries and Damped Concentric Mode (DCM) technology

Modern finishes

High-quality cabinet complete with a satin painted baffle seamlessly matched with the tweeter grille

Painted 21 mm front baffle

Provides an aesthetically pleasing contrast to the rest of the cabinet while ensuring rigidity at the areas it's needed the most

Outrigger feet

Sturdy steel outriggers with top spinners ensure a stable platform. Designed for use on carpeted (spikes) or hard floors (rubber feet)

Branding

3D metal plated branding to add a premium finish to the logo

Rigid 15 mm MDF construction

Stiff cabinet construction with crisp edges and corners for a clean and modern look

Single bolt through driver technology

Provides increased bracing strength, rigidity and driver/baffle de-coupling

Cabinet bracing

Braces placed optimally throughout the cabinet to reduce unwanted vibration through the cabinet walls

High quality crossovers

Utilising premium grade, bespoke polyester film and electrolytic capacitors, air-core and low-loss laminated steel-core inductors for maximum signal transfer and reduced distortion

Dual HiVe II ports

Improved transient response and tighter bass due to a smoother airflow

Pureflow silver-plated oxygen-free copper internal cabling

Highest quality current transfer through the signal chain

Terminal panel

High-quality gold-plated bi-wire terminals

Bespoke grilles

Sleek, audio transparent magnetic grilles to keep visual fittings to a minimum

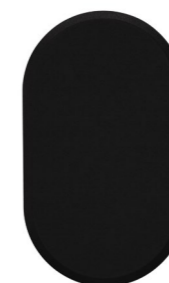
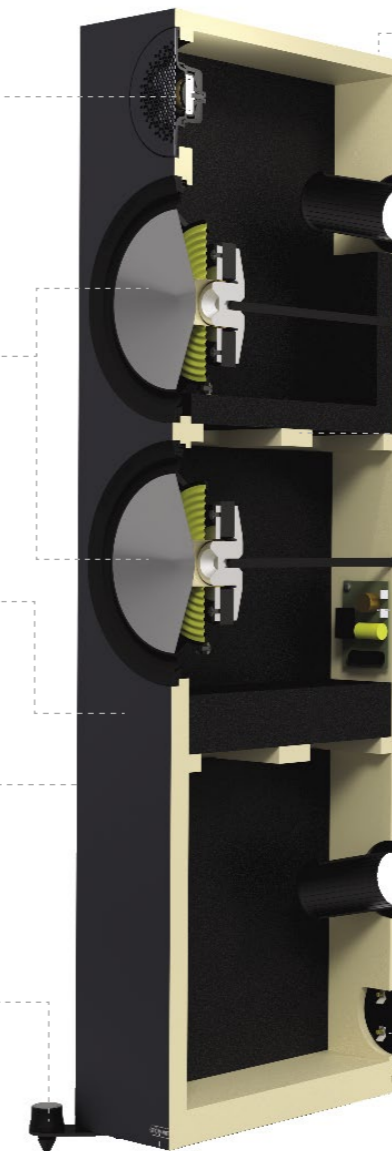

Bookshelf speakers

Choose between one of our two bookshelf/standmount speakers - the smaller, more compact Bronze 50 or the powerful, larger Bronze 100s. Both speaker models can be configured as stereo pairs or as part of a larger AV home cinema system.

Bronze 50

Designed to perform in the smallest of living spaces, the compact and bookshelf-friendly Bronze 50s will deliver the renowned Monitor Audio sound even when placed close to a wall. These truly versatile speakers are ideal for both hi-fi and home cinema playback and can also bring games to life by revealing fresh audio detail.

The Bronze 50s are the smallest speakers in the series and house our renowned C-CAM mid-bass driver and C-CAM Gold dome tweeter to ensure compelling audio reproduction with an improved stereo performance. The choice of four modern finishes and stylish contrasting baffle give the Bronze 50s a superior appearance and ensures they will match the décor wherever they are placed.

Our Bronze AMS Dolby Atmos® enabled speaker module can be placed on the Bronze 50s to heighten the surround experience. Should you prefer to have the speakers mounted on the wall, there's an option to do so utilising the rear fixing point and our FIX-M speaker mount.



Bronze 100

The Bronze 100 speakers are the natural step up from the Bronze 50s and feature larger cabinets to deliver a grander performance. Our renowned C-CAM technology in the new 8" driver guarantees a detailed and powerful listening experience. As with its smaller sibling, the Bronze 100's rear Hive II port is designed and tuned to facilitate easy positioning without affecting performance. The superior build quality and choice of contemporary finishes ensures that these striking speakers are a stylish addition to any home.

Floorstanding speakers

Choose between our two floorstanding speakers - the smaller, compact Bronze 200 or the larger and more powerful Bronze 500s. Both speaker models are kept perfectly in place by sturdy steel outrigger feet and they can be configured as stereo pairs or as part of a larger AV home cinema system.

Bronze 200

The beautifully proportioned Bronze 200 floorstanders deliver a surprisingly large sound. Replete with class-leading Monitor Audio technology they offer the perfect ratio of performance to size. The graceful speakers are equipped with our 25mm C-CAM Gold Dome tweeter featuring a Uniform Dispersion (UD) Waveguide and dual 5½" C-CAM mid-bass drivers. They are real crowd pleasers as they give a stunningly clear, open and detailed delivery.



Bronze 500

The Bronze 500s are the pinnacle of the series and deliver the powerful and detailed audio required by the most demanding of audiophiles. Their larger cabinet houses a Monitor Audio 25mm C-CAM Gold Dome tweeter featuring a Uniform Dispersion (UD) Waveguide, plus two new 8" drivers to power the biggest Bronze performance.

The elegantly statuesque loudspeakers will thrill both music and movie lovers with their powerful, natural and intricate audio reproduction. They look particularly striking in our new Urban Grey finish, which perfectly complements the décor of a modern room.

Centre Channel and Surround

The centre channel speaker delivers the dialogue in an AV home cinema system, whilst our FX surround speaker helps to create an immersive atmosphere.

Bronze C150

The Monitor Audio Bronze C150 centre speaker brings movies and music to vivid life and reveals the detail in every performance. Designed to partner left and right speakers, it should be positioned at the centre of the home cinema configuration. Its 25mm C-CAM Gold Dome Tweeter and two 5 1/2" C-CAM Mid-Bass drivers have exceptional dispersion abilities to guarantee a detailed wide-screen listen with seamless front soundstage action and articulate dialogue. The cabinet's discreet form ensures it looks good wherever it is placed.



Bronze FX

Nothing enhances the home cinema experience like a dedicated surround sound speaker and the Bronze FX is designed to immerse you in compelling audio. The compact and discreet cabinet incorporates two 25mm C-CAM Gold Dome tweeters with UD Waveguide and a 5 1/2" C-CAM mid-bass driver to deliver the Monitor Audio sonic magic.

We are masters of effects speaker design and the new Bronze FX delivers our renowned surround sound experience to maximum effect.

Dolby Atmos[®] and Subwoofer

Add Bronze AMS Dolby Atmos[®] enabled speakers to your AV home cinema system for a truly immersive experience. Add deep impact to your movie soundtracks with the Bronze W10 subwoofer.

Bronze AMS Dolby Atmos[®] Enabled Speakers

Dolby Atmos[®] brings soundtracks to life by surrounding the listener in moving audio that flows with a vivid three-dimensional realism. Our Bronze AMS Dolby Atmos[®] enabled speaker module has been designed to let you experience a new world of sound and features a 25mm C-CAM Gold dome tweeter with optimised waveguide and a 4" C-CAM Mid-Bass Driver to deliver a powerfully moving entertainment experience.

The module is up-firing and has been styled to sit on top of our Bronze 50 and Bronze 200 speakers. As it has the same footprint, it can also be paired with our Silver 50 and Silver 200 models. Additionally, it can be used as a height speaker in a home cinema configuration (without Dolby Atmos[®] functionality).



Bronze W10

If you love deep and refined bass notes, the Bronze W10 is a must-have addition to your speaker set-up as every soundscape is effortlessly reinforced by our beautifully designed subwoofer.

The Bronze W10's long-throw 10" C-CAM subwoofer driver combines with the 10" auxiliary bass radiator to bring a powerful and vivid realism to any performance. Be prepared to experience every rumble, shudder and judder of a movie soundtrack.

Bronze Series AV System Suggestions

There are many possible speaker configurations in order to achieve your perfect Bronze Series AV home cinema system, depending on your listening preferences and size of room. Adding the Bronze AMS Dolby Atmos® enabled speakers to your set-up will give an extra dimension to any movie soundtrack and they can also be used as front and/or rear loudspeakers in a two or four Dolby Atmos® speaker combination.



Placement Examples

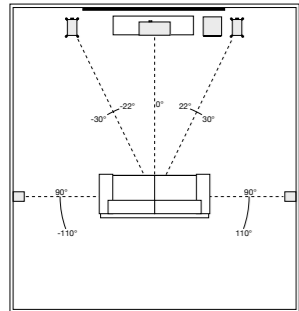

5.1 = Sides

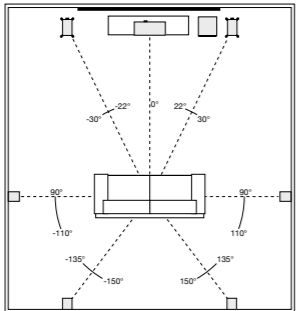

7.1 = Rear + Sides

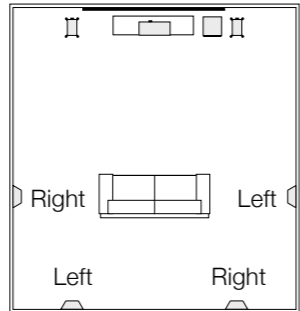

7.1 Bronze FX Only
Di-Pole Mode 

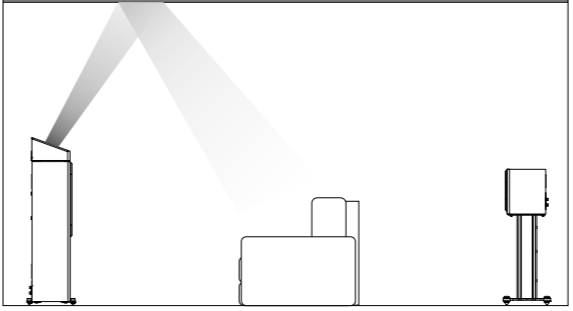

5.1.2 / 7.1.2

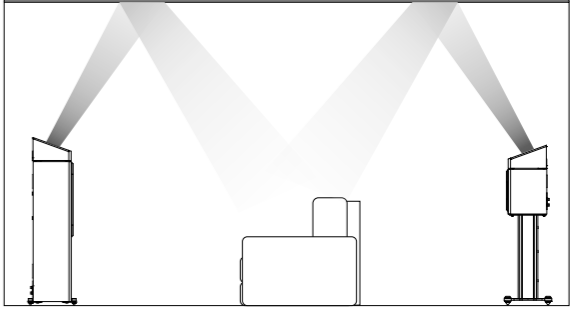

5.1.4 / 7.1.4



Two Tone

The Bronze Series has undergone a complete redesign, featuring four contemporary finishes (White, Walnut, Urban Grey and Black) with a sleek contrasting baffle and matching magnetic grille.

- White** – White vinyl and satin light grey front baffle
- Walnut** – Walnut wood vinyl and satin dark grey front baffle
- Urban Grey** – Grey wood vinyl and satin light grey front baffle
- Black** – Black vinyl and satin dark grey front baffle

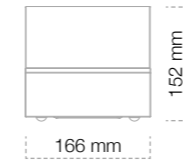

Bronze AMS

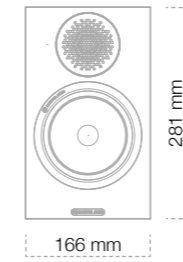

Bronze 50

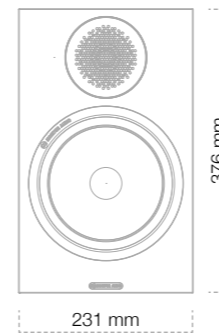

Bronze 100

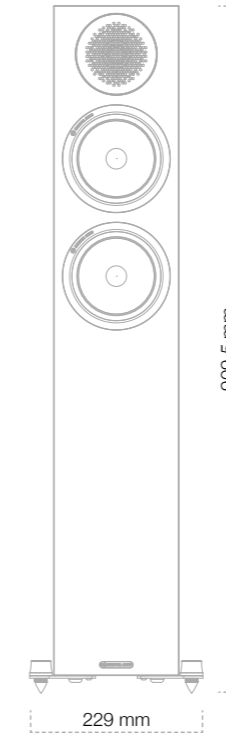

Bronze 200

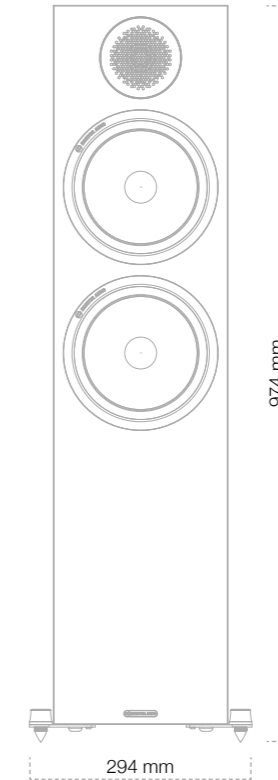

Bronze 500

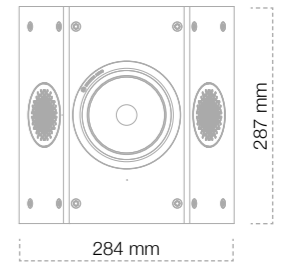

Bronze FX

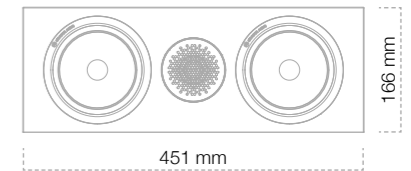

Bronze C150

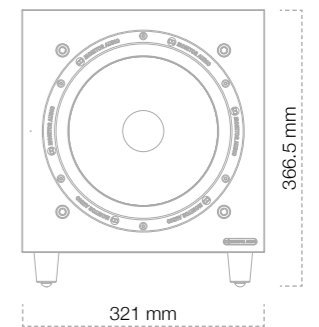

Bronze W10

Bronze Series Specifications

Model	Bronze 50	Bronze 100	Bronze 200	Bronze 500	Bronze C150	Bronze FX	Bronze AMS Dolby Atmos® Enabled Speaker
System Format	2-way	2-way	2.5-way	2.5-way	2-way	2-way	2-way
Frequency response (-6dB) Free field In room	62 Hz – 25 kHz 40 Hz – 30 kHz	52 Hz – 25 kHz 37 Hz – 30 kHz	45 Hz – 25 kHz 35 Hz – 30 kHz	41 Hz – 25 kHz 32 Hz – 30 kHz	83 Hz – 25 kHz 66 Hz – 30 kHz	88 Hz – 25 kHz 74 Hz – 30 kHz	120 Hz – 25 kHz 105 Hz – 30 kHz
Sensitivity (2.83v @ 1m)	85 dB	87 dB	88 dB	90 dB	88 dB	86 dB	86 dB
Nominal impedance	8 Ohms	8 Ohms	8 Ohms	8 Ohms	8 Ohms	8 Ohms	8 Ohms
Minimum Impedance	4.4 Ohms	4.5 Ohms	4.4 Ohms	4.1 Ohms	4.3 Ohms	4 Ohms	4 Ohms
Maximum SPL	107 dBA (pair)	110 dBA (pair)	112 dBA (pair)	116 dBA (pair)	109 dBA (each)	108 dBA (pair)	107 dBA (pair)
Power Handling (RMS)	80 W	100 W	120 W	200 W	120 W	80 W	60 W
Recommended Amplifier Requirements	20 – 80 W	30 – 100 W	40 – 120 W	60 – 200 W	30 – 120 W	20 – 80 W	10 – 60 W
Bass Alignment	Bass reflex HiVe II port system	Bass reflex HiVe II port system	Bass reflex Dual HiVe II port system	Bass reflex Dual HiVe II port system	Sealed cabinet	Sealed cabinet	Sealed cabinet
Crossover Frequency	2,5 kHz	2,2 kHz	700 Hz 2,4 kHz	550 Hz 2,7 kHz	2,7 kHz	2,8 kHz	2,5 kHz
Drive Unit Complement	1 x 5 ^{1/2} " C-CAM mid- bass driver 1 x 25 mm C-CAM Gold Dome tweeter with UD Waveguide	1 x 8" C-CAM mid- bass driver 1 x 25 mm C-CAM Gold Dome tweeter with UD Waveguide	2 x 5 ^{1/2} " C-CAM mid- bass driver 1 x 25 mm C-CAM Gold Dome tweeter with UD Waveguide	2 x 8" C-CAM mid- bass driver 1 x 25 mm C-CAM Gold Dome tweeter with UD Waveguide	2 x 5 ^{1/2} " C-CAM mid- bass driver 1 x 25 mm C-CAM Gold Dome tweeter with UD Waveguide	1 x 5 ^{1/2} " C-CAM mid- bass driver 2 x 25 mm C-CAM Gold Dome tweeter with UD Waveguide	1 x 4" C-CAM mid- bass driver 1 x 25 mm C-CAM Gold Dome tweeter with optimised Waveguide*
External Dimensions including Grille and Terminals (H x W x D)	281 x 166 x 265 mm 11 ^{1/16} x 6 ^{9/16} x 10 ^{7/16} "	376 x 231 x 325 mm 14 ^{13/16} x 9 ^{1/8} x 12 ^{13/16} "	886 x 166 x 265 mm 34 ^{7/8} x 6 ^{9/16} x 10 ^{7/16} "	951 x 231 x 325 mm 37 ^{7/16} x 9 ^{1/8} x 12 ^{13/16} "	166 x 451 x 225 mm 6 ^{9/16} x 17 ^{3/4} x 8 ^{9/16} "	287 x 284 x 124 mm 11 ^{5/16} x 11 ^{3/16} x 4 ^{7/8} "	152 x 166 x 242 mm 6 x 6 ^{9/16} x 9 ^{1/2} "
External Dimensions including Outrigger Feet and Spikes (H x W x D)	N/A	N/A	909 x 229 x 304 mm 35 ^{13/16} x 9 x 11 ^{15/16} "	974 x 294 x 364 mm 38 ^{3/8} x 11 ^{9/16} x 14 ^{5/16} "	N/A	N/A	N/A
Weight (Each)	5.0 kg 11 lb	7.8 kg 17 lb 3 oz	12.8 kg 28 lb 4 oz	18.0 kg 39 lb 11 oz	7.0 kg 15 lb 7 oz	3.9 kg 8 lb 10 oz	2.5 kg 5 lb 8 oz
Finishes	Black, White, Walnut, Urban Grey					Black, White	Black, White

* Waveguide optimised to comply with Dolby Atmos® directivity targets

E&OE All colours approximate.

For more information email info@monitoraudio.com

Additional technical details on the Bronze Series are available at monitoraudio.com

Manufactured under license from Dolby Laboratories.

Dolby, Dolby Atmos, and the double-D symbol are trademarks of Dolby Laboratories.

Bronze W10 Subwoofer Specifications

Model	Bronze W10 Subwoofer
System Format	Long-throw 10" driver featuring 'dished' C-CAM cone. 10" flat panel ABR (Auxiliary Bass Radiator). 18 mm MDF internally braced construction
Lower Frequency Limit	-3 dB @ 33 Hz / -10 dB @ 28 Hz (Free Field) Default preset: Music, -3 dB @ 29 Hz / -10 dB @ 25 Hz (In room)
Upper Frequency Limit	-6 dB @ 150 Hz
Drive Unit Complement	1 x 250 mm (10") C-CAM subwoofer driver featuring a 2" long throw voice coil
Linear Driver Excursion	17 mm peak to peak
Amplifier Output	220 W
Amplifier Classification	Class D with high current Switch mode power supply (SMPSU)
Phase Control	0 Degrees & 180 Degree pure Invert
Low Pass Filter Alignment	2nd order (12 dB/Octave), from 40 Hz to 120 Hz
Equalisation DSP	3 pre-set modes: Music, Movie, Impact
Auto Sensing	Line Level >3mV. Auto Standby feature after 20 mins
Audio Inputs	LFE unbalanced input RCA Stereo unbalanced inputs RCA
Input Impedance	20 kOhms input impedance
12 V Trigger	3.5 mm mono mini-jack. 6 V threshold
Electrical Certifications	CE / CB / ETL / FCC / CCC / ErP (Energy saving compliant)
Mains Input Voltage	100 – 120 VAC ~60Hz / 220 – 240 VAC ~50/60 Hz (Manually selected)
Power Consumption	Maximum 300 W, Standby <0.5 W (ErP compliance)
Fuse Type	20 mm T4AL 250 VAC
External Dimensions including Amp, Drivers & Terminals (H x W x D)	321 x 321 x 364 mm 12 ^{5/8} x 12 ^{5/8} x 14 ^{5/16} "
External Dimensions including Amp, Drivers, Terminals & Feet (H x W x D)	366.5 x 321 x 364 mm 14 ^{7/16} x 12 ^{5/8} x 14 ^{5/16} "
Weight (Unpacked)	13.4 kg / 29 lb 9 oz
Finishes	Black, White, Walnut, Urban Grey

Monitor Audio Ltd

24 Brook Road, Rayleigh,
Essex, SS6 7XJ, England

T. + 44 (0)1268 740580

F. + 44 (0)1268 740589

E. info@monitoraudio.com

monitoraudio.com